



# wwPDB X-ray Structure Validation Summary Report ⓘ

Nov 22, 2023 – 06:50 PM JST

PDB ID : 7WYJ  
Title : Structure of the complex of lactoperoxidase with nitric oxide catalytic product nitrite at 1.89 Å resolution  
Authors : Viswanathan, V.; Pandey, N.; Singh, A.K.; Sinha, M.; Singh, R.P.; Sharma, P.; Kaur, P.; Sharma, S.; Singh, T.P.  
Deposited on : 2022-02-16  
Resolution : 1.89 Å(reported)

This is a wwPDB X-ray Structure Validation Summary Report for a publicly released PDB entry.

We welcome your comments at [validation@mail.wwpdb.org](mailto:validation@mail.wwpdb.org)

A user guide is available at

<https://www.wwpdb.org/validation/2017/XrayValidationReportHelp>

with specific help available everywhere you see the ⓘ symbol.

The types of validation reports are described at

<http://www.wwpdb.org/validation/2017/FAQs#types>.

---

The following versions of software and data (see [references ⓘ](#)) were used in the production of this report:

MolProbity : 4.02b-467  
Mogul : 1.8.5 (274361), CSD as541be (2020)  
Xtriage (Phenix) : 1.13  
EDS : 2.36  
buster-report : 1.1.7 (2018)  
Percentile statistics : 20191225.v01 (using entries in the PDB archive December 25th 2019)  
Refmac : 5.8.0158  
CCP4 : 7.0.044 (Gargrove)  
Ideal geometry (proteins) : Engh & Huber (2001)  
Ideal geometry (DNA, RNA) : Parkinson et al. (1996)  
Validation Pipeline (wwPDB-VP) : 2.36

# 1 Overall quality at a glance

The following experimental techniques were used to determine the structure:

*X-RAY DIFFRACTION*

The reported resolution of this entry is 1.89 Å.

Percentile scores (ranging between 0-100) for global validation metrics of the entry are shown in the following graphic. The table shows the number of entries on which the scores are based.

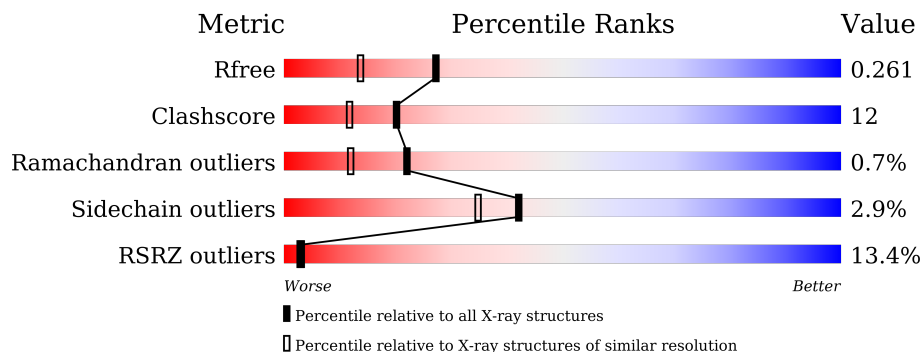

Metric	Whole archive (#Entries)	Similar resolution (#Entries, resolution range(Å))
$R_{free}$	130704	6207 (1.90-1.90)
Clashscore	141614	6847 (1.90-1.90)
Ramachandran outliers	138981	6760 (1.90-1.90)
Sidechain outliers	138945	6760 (1.90-1.90)
RSRZ outliers	127900	6082 (1.90-1.90)

The table below summarises the geometric issues observed across the polymeric chains and their fit to the electron density. The red, orange, yellow and green segments of the lower bar indicate the fraction of residues that contain outliers for  $\geq 3$ , 2, 1 and 0 types of geometric quality criteria respectively. A grey segment represents the fraction of residues that are not modelled. The numeric value for each fraction is indicated below the corresponding segment, with a dot representing fractions  $\leq 5\%$ . The upper red bar (where present) indicates the fraction of residues that have poor fit to the electron density. The numeric value is given above the bar.

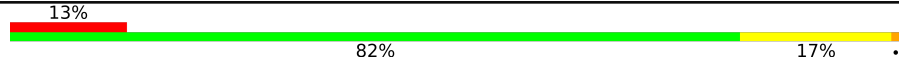
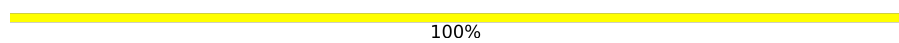
Mol	Chain	Length	Quality of chain
1	A	595	
2	B	2	

The following table lists non-polymeric compounds, carbohydrate monomers and non-standard residues in protein, DNA, RNA chains that are outliers for geometric or electron-density-fit criteria:

Mol	Type	Chain	Res	Chirality	Geometry	Clashes	Electron density
4	IOD	A	608[B]	-	-	X	-
4	IOD	A	610	-	-	X	-
4	IOD	A	620[B]	-	-	X	-
4	IOD	A	621	-	-	X	-
4	IOD	A	622[B]	-	-	X	-
4	IOD	A	622[C]	-	-	X	-
4	IOD	A	626[A]	-	-	X	-
4	IOD	A	627[B]	-	-	X	-
4	IOD	A	627[C]	-	-	X	-
4	IOD	A	631[B]	-	-	X	-
7	NO2	A	614	-	-	X	-

## 2 Entry composition [i](#)

There are 11 unique types of molecules in this entry. The entry contains 5454 atoms, of which 0 are hydrogens and 0 are deuteriums.

In the tables below, the ZeroOcc column contains the number of atoms modelled with zero occupancy, the AltConf column contains the number of residues with at least one atom in alternate conformation and the Trace column contains the number of residues modelled with at most 2 atoms.

- Molecule 1 is a protein called Lactoperoxidase.

Mol	Chain	Residues	Atoms					ZeroOcc	AltConf	Trace
			Total	C	N	O	S			
1	A	595	4783	3045	850	862	26	0	2	0

- Molecule 2 is an oligosaccharide called 2-acetamido-2-deoxy-beta-D-glucopyranose-(1-4)-2-acetamido-2-deoxy-beta-D-glucopyranose.



Mol	Chain	Residues	Atoms				ZeroOcc	AltConf	Trace
			Total	C	N	O			
2	B	2	28	16	2	10	0	0	0

- Molecule 3 is CALCIUM ION (three-letter code: CA) (formula: Ca) (labeled as "Ligand of Interest" by depositor).

Mol	Chain	Residues	Atoms		ZeroOcc	AltConf
3	A	1	Total	Ca	0	0
			1	1		

- Molecule 4 is IODIDE ION (three-letter code: IOD) (formula: I) (labeled as "Ligand of Interest" by depositor).

Mol	Chain	Residues	Atoms		ZeroOcc	AltConf
4	A	22	Total	I	0	12
			38	38		

- Molecule 5 is THIOCYANATE ION (three-letter code: SCN) (formula: CNS) (labeled as "Ligand of Interest" by depositor).

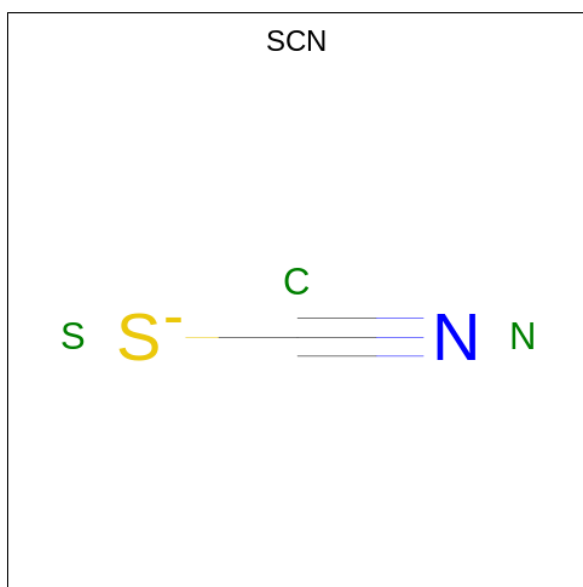

Mol	Chain	Residues	Atoms				ZeroOcc	AltConf
5	A	1	Total	C	N	S	0	0
			3	1	1	1		
5	A	1	Total	C	N	S	0	0
			3	1	1	1		
5	A	1	Total	C	N	S	0	0
			3	1	1	1		

- Molecule 6 is 1,2-ETHANEDIOL (three-letter code: EDO) (formula: C<sub>2</sub>H<sub>6</sub>O<sub>2</sub>) (labeled as "Ligand of Interest" by depositor).

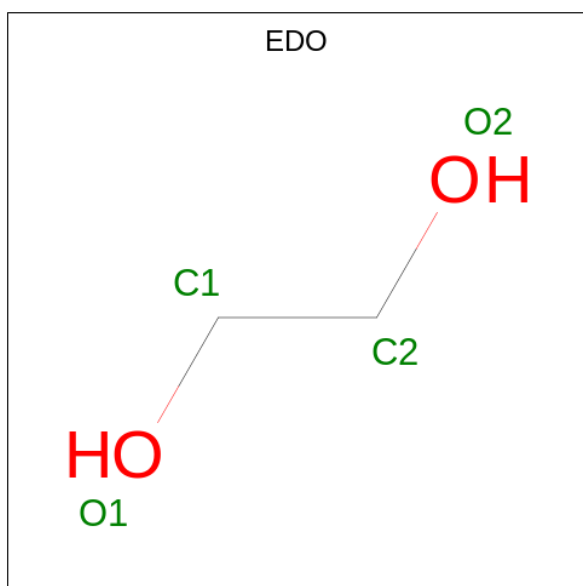

Mol	Chain	Residues	Atoms			ZeroOcc	AltConf
6	A	1	Total	C	O	0	0
			4	2	2		
6	A	1	Total	C	O	0	0
			4	2	2		
6	A	1	Total	C	O	0	0
			4	2	2		

- Molecule 7 is NITRITE ION (three-letter code: NO2) (formula: NO<sub>2</sub>) (labeled as "Ligand of Interest" by depositor).

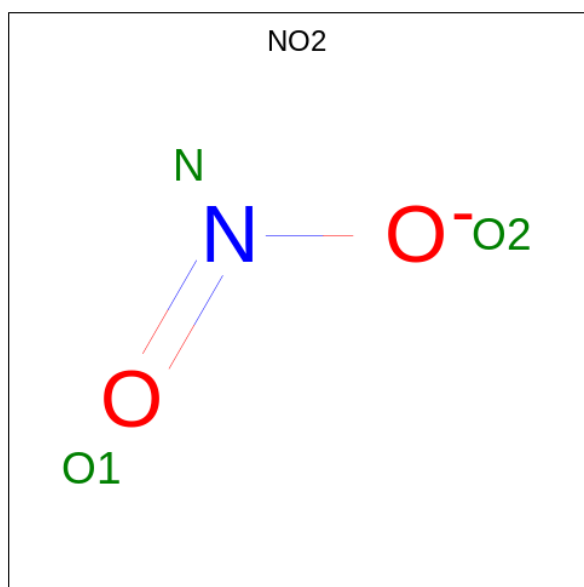

Mol	Chain	Residues	Atoms			ZeroOcc	AltConf
7	A	1	Total	N	O	0	0
			3	1	2		

- Molecule 8 is PROTOPORPHYRIN IX CONTAINING FE (three-letter code: HEM) (formula: C<sub>34</sub>H<sub>32</sub>FeN<sub>4</sub>O<sub>4</sub>) (labeled as "Ligand of Interest" by depositor).

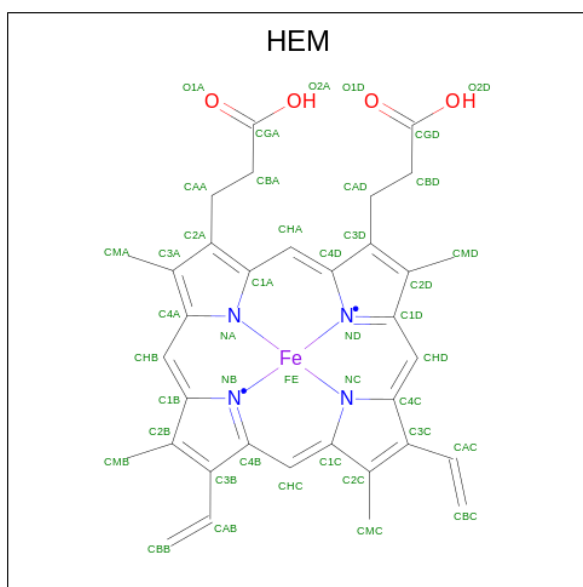

Mol	Chain	Residues	Atoms					ZeroOcc	AltConf
8	A	1	Total	C	Fe	N	O	0	1
			48	37	1	4	6		

- Molecule 9 is ZINC ION (three-letter code: ZN) (formula: Zn) (labeled as "Ligand of Interest" by depositor).

Mol	Chain	Residues	Atoms		ZeroOcc	AltConf
9	A	1	Total	Zn	0	1
			2	2		

- Molecule 10 is 2-acetamido-2-deoxy-beta-D-glucopyranose (three-letter code: NAG) (formula: C<sub>8</sub>H<sub>15</sub>NO<sub>6</sub>) (labeled as "Ligand of Interest" by depositor).

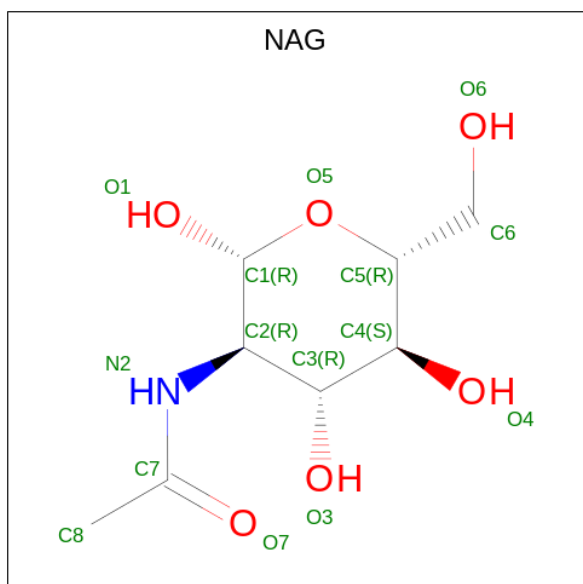

Mol	Chain	Residues	Atoms				ZeroOcc	AltConf
10	A	1	Total	C	N	O	0	0
			14	8	1	5		
10	A	1	Total	C	N	O	0	0
			14	8	1	5		
10	A	1	Total	C	N	O	0	0
			14	8	1	5		

- Molecule 11 is water.

Mol	Chain	Residues	Atoms		ZeroOcc	AltConf
11	A	481	Total	O	0	7
			488	488		



### 3 Residue-property plots [i](#)

These plots are drawn for all protein, RNA, DNA and oligosaccharide chains in the entry. The first graphic for a chain summarises the proportions of the various outlier classes displayed in the second graphic. The second graphic shows the sequence view annotated by issues in geometry and electron density. Residues are color-coded according to the number of geometric quality criteria for which they contain at least one outlier: green = 0, yellow = 1, orange = 2 and red = 3 or more. A red dot above a residue indicates a poor fit to the electron density ( $RSRZ > 2$ ). Stretches of 2 or more consecutive residues without any outlier are shown as a green connector. Residues present in the sample, but not in the model, are shown in grey.

- Molecule 1: Lactoperoxidase

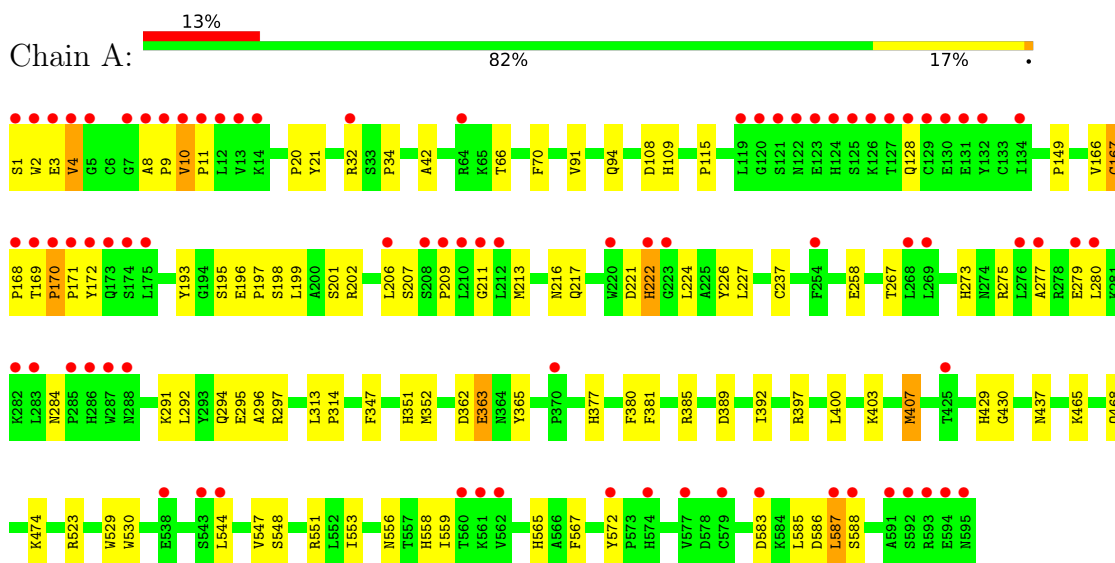

- Molecule 2: 2-acetamido-2-deoxy-beta-D-glucopyranose-(1-4)-2-acetamido-2-deoxy-beta-D-glucopyranose

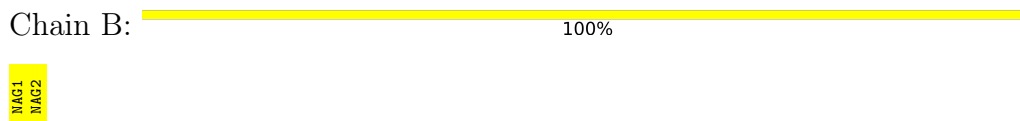

## 4 Data and refinement statistics i

Property	Value	Source
Space group	P 1 21 1	Depositor
Cell constants a, b, c, $\alpha$ , $\beta$ , $\gamma$	53.99Å 79.93Å 76.31Å 90.00° 102.18° 90.00°	Depositor
Resolution (Å)	35.30 – 1.89 35.30 – 1.89	Depositor EDS
% Data completeness (in resolution range)	99.9 (35.30-1.89) 100.0 (35.30-1.89)	Depositor EDS
$R_{merge}$	(Not available)	Depositor
$R_{sym}$	0.09	Depositor
$\langle I/\sigma(I) \rangle$ <sup>1</sup>	4.50 (at 1.89Å)	Xtrriage
Refinement program	REFMAC 5.8.0267	Depositor
R, $R_{free}$	0.203 , 0.258 0.209 , 0.261	Depositor DCC
$R_{free}$ test set	2580 reflections (5.08%)	wwPDB-VP
Wilson B-factor (Å <sup>2</sup> )	23.0	Xtrriage
Anisotropy	0.089	Xtrriage
Bulk solvent $k_{sol}$ (e/Å <sup>3</sup> ), $B_{sol}$ (Å <sup>2</sup> )	0.32 , 52.6	EDS
L-test for twinning <sup>2</sup>	$\langle  L  \rangle = 0.50$ , $\langle L^2 \rangle = 0.33$	Xtrriage
Estimated twinning fraction	No twinning to report.	Xtrriage
$F_o, F_c$ correlation	0.94	EDS
Total number of atoms	5454	wwPDB-VP
Average B, all atoms (Å <sup>2</sup> )	36.0	wwPDB-VP

Xtrriage's analysis on translational NCS is as follows: *The largest off-origin peak in the Patterson function is 6.18% of the height of the origin peak. No significant pseudotranslation is detected.*

<sup>1</sup>Intensities estimated from amplitudes.

<sup>2</sup>Theoretical values of  $\langle |L| \rangle$ ,  $\langle L^2 \rangle$  for acentric reflections are 0.5, 0.333 respectively for untwinned datasets, and 0.375, 0.2 for perfectly twinned datasets.

## 5 Model quality [i](#)

### 5.1 Standard geometry [i](#)

Bond lengths and bond angles in the following residue types are not validated in this section: NAG, IOD, ZN, SCN, CA, EDO, HEM, NO2

The Z score for a bond length (or angle) is the number of standard deviations the observed value is removed from the expected value. A bond length (or angle) with  $|Z| > 5$  is considered an outlier worth inspection. RMSZ is the root-mean-square of all Z scores of the bond lengths (or angles).

Mol	Chain	Bond lengths		Bond angles	
		RMSZ	# Z  >5	RMSZ	# Z  >5
1	A	0.73	0/4917	0.82	0/6670

There are no bond length outliers.

There are no bond angle outliers.

There are no chirality outliers.

There are no planarity outliers.

### 5.2 Too-close contacts [i](#)

In the following table, the Non-H and H(model) columns list the number of non-hydrogen atoms and hydrogen atoms in the chain respectively. The H(added) column lists the number of hydrogen atoms added and optimized by MolProbity. The Clashes column lists the number of clashes within the asymmetric unit, whereas Symm-Clashes lists symmetry-related clashes.

Mol	Chain	Non-H	H(model)	H(added)	Clashes	Symm-Clashes
1	A	4783	0	4705	111	0
2	B	28	0	25	0	0
3	A	1	0	0	0	0
4	A	38	0	0	41	0
5	A	9	0	0	2	0
6	A	12	0	18	2	0
7	A	3	0	0	5	0
8	A	48	0	8	2	0
9	A	2	0	0	0	0
10	A	42	0	39	0	0
11	A	488	0	0	16	0
All	All	5454	0	4795	120	0

The all-atom clashscore is defined as the number of clashes found per 1000 atoms (including

hydrogen atoms). The all-atom clashscore for this structure is 12.

The worst 5 of 120 close contacts within the same asymmetric unit are listed below, sorted by their clash magnitude.

Atom-1	Atom-2	Interatomic distance (Å)	Clash overlap (Å)
1:A:559:ILE:HA	4:A:627[B]:IOD:I	1.97	1.35
1:A:222:HIS:HB3	4:A:626[A]:IOD:I	2.04	1.27
1:A:216:ASN:HA	4:A:608[B]:IOD:I	2.17	1.15
4:A:625:IOD:I	11:A:1039:HOH:O	2.36	1.14
1:A:429:HIS:O	4:A:621:IOD:I	2.43	1.06

There are no symmetry-related clashes.

## 5.3 Torsion angles [i](#)

### 5.3.1 Protein backbone [i](#)

In the following table, the Percentiles column shows the percent Ramachandran outliers of the chain as a percentile score with respect to all X-ray entries followed by that with respect to entries of similar resolution.

The Analysed column shows the number of residues for which the backbone conformation was analysed, and the total number of residues.

Mol	Chain	Analysed	Favoured	Allowed	Outliers	Percentiles
1	A	595/595 (100%)	549 (92%)	42 (7%)	4 (1%)	22 12

All (4) Ramachandran outliers are listed below:

Mol	Chain	Res	Type
1	A	167	CYS
1	A	170	PRO
1	A	4	VAL
1	A	10	VAL

### 5.3.2 Protein sidechains [i](#)

In the following table, the Percentiles column shows the percent sidechain outliers of the chain as a percentile score with respect to all X-ray entries followed by that with respect to entries of similar resolution.

The Analysed column shows the number of residues for which the sidechain conformation was analysed, and the total number of residues.

Mol	Chain	Analysed	Rotameric	Outliers	Percentiles
1	A	520/518 (100%)	505 (97%)	15 (3%)	42 35

5 of 15 residues with a non-rotameric sidechain are listed below:

Mol	Chain	Res	Type
1	A	197	PRO
1	A	465	LYS
1	A	201	SER
1	A	587	LEU
1	A	363	GLU

Sometimes sidechains can be flipped to improve hydrogen bonding and reduce clashes. All (3) such sidechains are listed below:

Mol	Chain	Res	Type
1	A	124	HIS
1	A	138	ASN
1	A	570	ASN

### 5.3.3 RNA [i](#)

There are no RNA molecules in this entry.

## 5.4 Non-standard residues in protein, DNA, RNA chains [i](#)

There are no non-standard protein/DNA/RNA residues in this entry.

## 5.5 Carbohydrates [i](#)

2 monosaccharides are modelled in this entry.

In the following table, the Counts columns list the number of bonds (or angles) for which Mogul statistics could be retrieved, the number of bonds (or angles) that are observed in the model and the number of bonds (or angles) that are defined in the Chemical Component Dictionary. The Link column lists molecule types, if any, to which the group is linked. The Z score for a bond length (or angle) is the number of standard deviations the observed value is removed from the expected value. A bond length (or angle) with  $|Z| > 2$  is considered an outlier worth inspection. RMSZ is the root-mean-square of all Z scores of the bond lengths (or angles).

Mol	Type	Chain	Res	Link	Bond lengths			Bond angles		
					Counts	RMSZ	# Z  > 2	Counts	RMSZ	# Z  > 2
2	NAG	B	1	1,2	14,14,15	0.63	0	17,19,21	1.55	4 (23%)

Mol	Type	Chain	Res	Link	Bond lengths			Bond angles		
					Counts	RMSZ	# Z  > 2	Counts	RMSZ	# Z  > 2
2	NAG	B	2	2	14,14,15	0.32	0	17,19,21	1.62	2 (11%)

In the following table, the Chirals column lists the number of chiral outliers, the number of chiral centers analysed, the number of these observed in the model and the number defined in the Chemical Component Dictionary. Similar counts are reported in the Torsion and Rings columns. '-' means no outliers of that kind were identified.

Mol	Type	Chain	Res	Link	Chirals	Torsions	Rings
2	NAG	B	1	1,2	-	0/6/23/26	0/1/1/1
2	NAG	B	2	2	-	2/6/23/26	0/1/1/1

There are no bond length outliers.

The worst 5 of 6 bond angle outliers are listed below:

Mol	Chain	Res	Type	Atoms	Z	Observed(°)	Ideal(°)
2	B	2	NAG	C1-O5-C5	5.37	119.47	112.19
2	B	2	NAG	C4-C3-C2	-3.07	106.52	111.02
2	B	1	NAG	O5-C1-C2	2.33	114.96	111.29
2	B	1	NAG	O7-C7-N2	2.29	126.16	121.95
2	B	1	NAG	C6-C5-C4	2.10	117.93	113.00

There are no chirality outliers.

All (2) torsion outliers are listed below:

Mol	Chain	Res	Type	Atoms
2	B	2	NAG	O5-C5-C6-O6
2	B	2	NAG	C4-C5-C6-O6

There are no ring outliers.

No monomer is involved in short contacts.

The following is a two-dimensional graphical depiction of Mogul quality analysis of bond lengths, bond angles, torsion angles, and ring geometry for oligosaccharide.

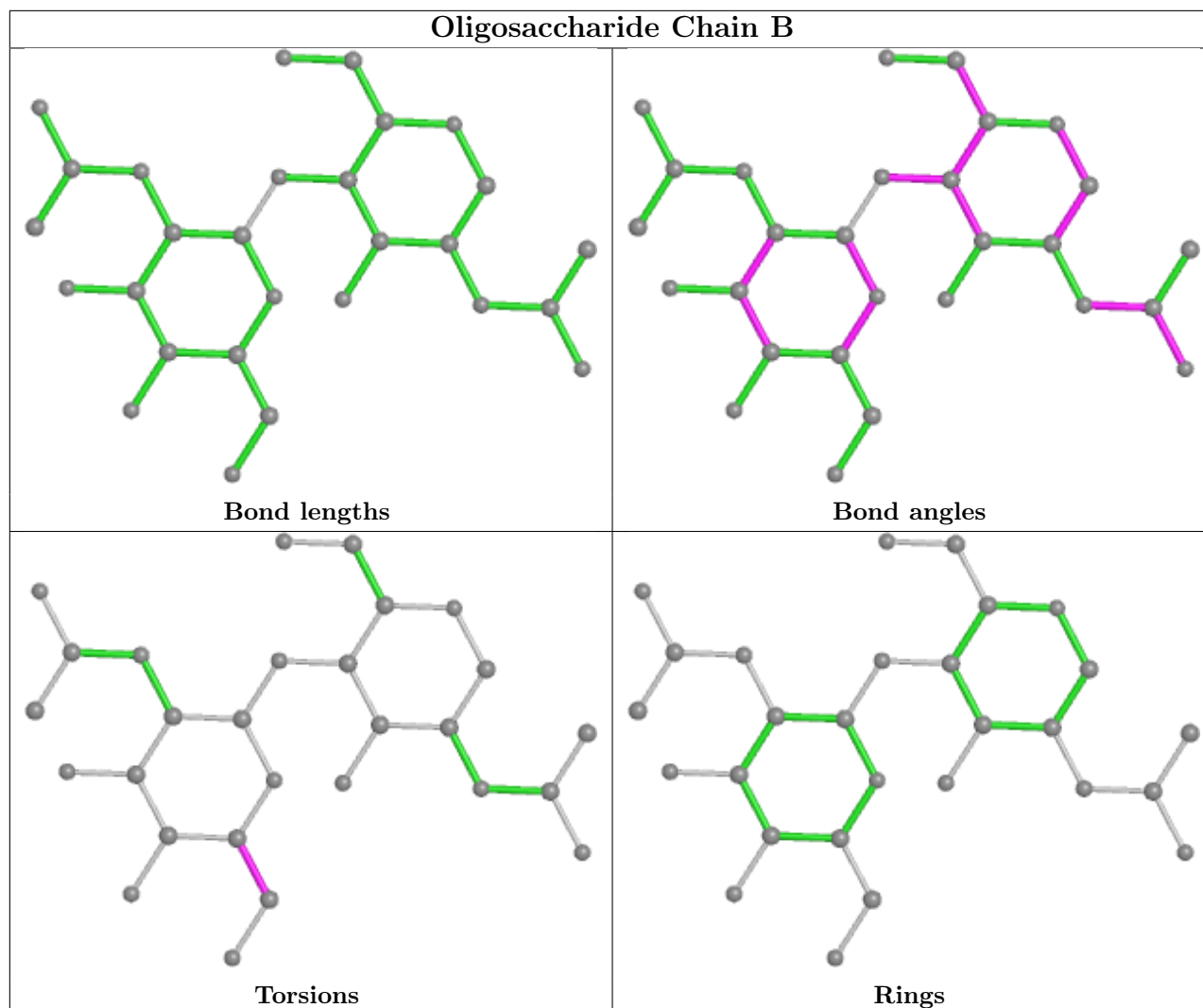

## 5.6 Ligand geometry [i](#)

Of 53 ligands modelled in this entry, 41 are monoatomic - leaving 12 for Mogul analysis.

In the following table, the Counts columns list the number of bonds (or angles) for which Mogul statistics could be retrieved, the number of bonds (or angles) that are observed in the model and the number of bonds (or angles) that are defined in the Chemical Component Dictionary. The Link column lists molecule types, if any, to which the group is linked. The Z score for a bond length (or angle) is the number of standard deviations the observed value is removed from the expected value. A bond length (or angle) with  $|Z| > 2$  is considered an outlier worth inspection. RMSZ is the root-mean-square of all Z scores of the bond lengths (or angles).

Mol	Type	Chain	Res	Link	Bond lengths			Bond angles		
					Counts	RMSZ	$\# Z  > 2$	Counts	RMSZ	$\# Z  > 2$
8	HEM	A	616[B]	-	41,50,50	1.37	8 (19%)	45,82,82	1.99	13 (28%)
5	SCN	A	611	-	1,2,2	0.92	0	0,1,1	-	-
6	EDO	A	615	-	3,3,3	0.13	0	2,2,2	0.70	0

Mol	Type	Chain	Res	Link	Bond lengths			Bond angles		
					Counts	RMSZ	# Z  > 2	Counts	RMSZ	# Z  > 2
10	NAG	A	633	1	14,14,15	0.57	0	17,19,21	0.98	1 (5%)
8	HEM	A	616[A]	-	41,50,50	1.23	6 (14%)	45,82,82	1.96	11 (24%)
7	NO2	A	614	8	1,2,2	0.15	0	0,1,1	-	-
10	NAG	A	635	1	14,14,15	0.29	0	17,19,21	1.60	4 (23%)
6	EDO	A	612	-	3,3,3	0.41	0	2,2,2	0.52	0
5	SCN	A	617	-	1,2,2	0.78	0	0,1,1	-	-
5	SCN	A	618	-	1,2,2	1.21	0	0,1,1	-	-
6	EDO	A	613	-	3,3,3	0.05	0	2,2,2	0.15	0
10	NAG	A	634	1	14,14,15	0.61	0	17,19,21	1.35	1 (5%)

In the following table, the Chirals column lists the number of chiral outliers, the number of chiral centers analysed, the number of these observed in the model and the number defined in the Chemical Component Dictionary. Similar counts are reported in the Torsion and Rings columns. '-' means no outliers of that kind were identified.

Mol	Type	Chain	Res	Link	Chirals	Torsions	Rings
8	HEM	A	616[B]	-	-	4/12/54/54	-
6	EDO	A	615	-	-	1/1/1/1	-
10	NAG	A	633	1	-	0/6/23/26	0/1/1/1
8	HEM	A	616[A]	-	-	5/12/54/54	-
10	NAG	A	635	1	-	0/6/23/26	0/1/1/1
6	EDO	A	612	-	-	0/1/1/1	-
6	EDO	A	613	-	-	0/1/1/1	-
10	NAG	A	634	1	-	0/6/23/26	0/1/1/1

The worst 5 of 14 bond length outliers are listed below:

Mol	Chain	Res	Type	Atoms	Z	Observed(Å)	Ideal(Å)
8	A	616[B]	HEM	CBD-CGD	3.01	1.57	1.50
8	A	616[A]	HEM	C1B-NB	-2.88	1.35	1.40
8	A	616[B]	HEM	C1B-NB	-2.88	1.35	1.40
8	A	616[A]	HEM	C4B-NB	-2.56	1.33	1.38
8	A	616[B]	HEM	C4B-NB	-2.56	1.33	1.38

The worst 5 of 30 bond angle outliers are listed below:

Mol	Chain	Res	Type	Atoms	Z	Observed(°)	Ideal(°)
8	A	616[A]	HEM	CHC-C4B-NB	5.03	129.90	124.43
8	A	616[B]	HEM	CHC-C4B-NB	5.03	129.90	124.43
8	A	616[A]	HEM	C1B-NB-C4B	4.42	109.63	105.07
8	A	616[B]	HEM	C1B-NB-C4B	4.42	109.63	105.07

Continued on next page...



*Continued from previous page...*

Mol	Chain	Res	Type	Atoms	Z	Observed(°)	Ideal(°)
10	A	635	NAG	C1-O5-C5	4.36	118.10	112.19

There are no chirality outliers.

5 of 10 torsion outliers are listed below:

Mol	Chain	Res	Type	Atoms
8	A	616[A]	HEM	C3D-CAD-CBD-CGD
6	A	615	EDO	O1-C1-C2-O2
8	A	616[A]	HEM	CAA-CBA-CGA-O1A
8	A	616[B]	HEM	CAA-CBA-CGA-O1A
8	A	616[A]	HEM	CAA-CBA-CGA-O2A

There are no ring outliers.

6 monomers are involved in 9 short contacts:

Mol	Chain	Res	Type	Clashes	Symm-Clashes
6	A	615	EDO	1	0
8	A	616[A]	HEM	2	0
7	A	614	NO2	5	0
6	A	612	EDO	1	0
5	A	617	SCN	1	0
5	A	618	SCN	1	0

The following is a two-dimensional graphical depiction of Mogul quality analysis of bond lengths, bond angles, torsion angles, and ring geometry for all instances of the Ligand of Interest. In addition, ligands with molecular weight > 250 and outliers as shown on the validation Tables will also be included. For torsion angles, if less than 5% of the Mogul distribution of torsion angles is within 10 degrees of the torsion angle in question, then that torsion angle is considered an outlier. Any bond that is central to one or more torsion angles identified as an outlier by Mogul will be highlighted in the graph. For rings, the root-mean-square deviation (RMSD) between the ring in question and similar rings identified by Mogul is calculated over all ring torsion angles. If the average RMSD is greater than 60 degrees and the minimal RMSD between the ring in question and any Mogul-identified rings is also greater than 60 degrees, then that ring is considered an outlier. The outliers are highlighted in purple. The color gray indicates Mogul did not find sufficient equivalents in the CSD to analyse the geometry.

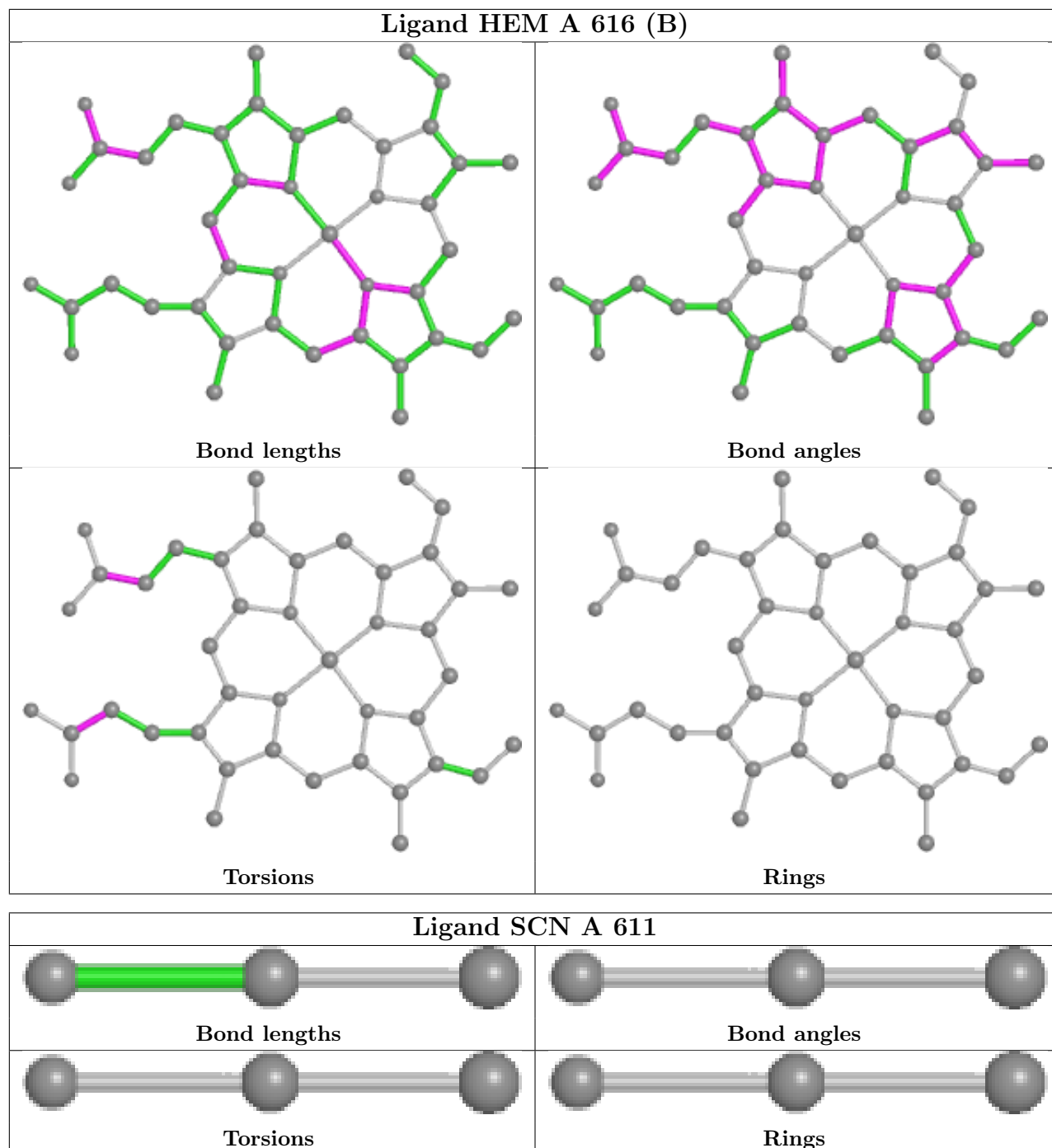

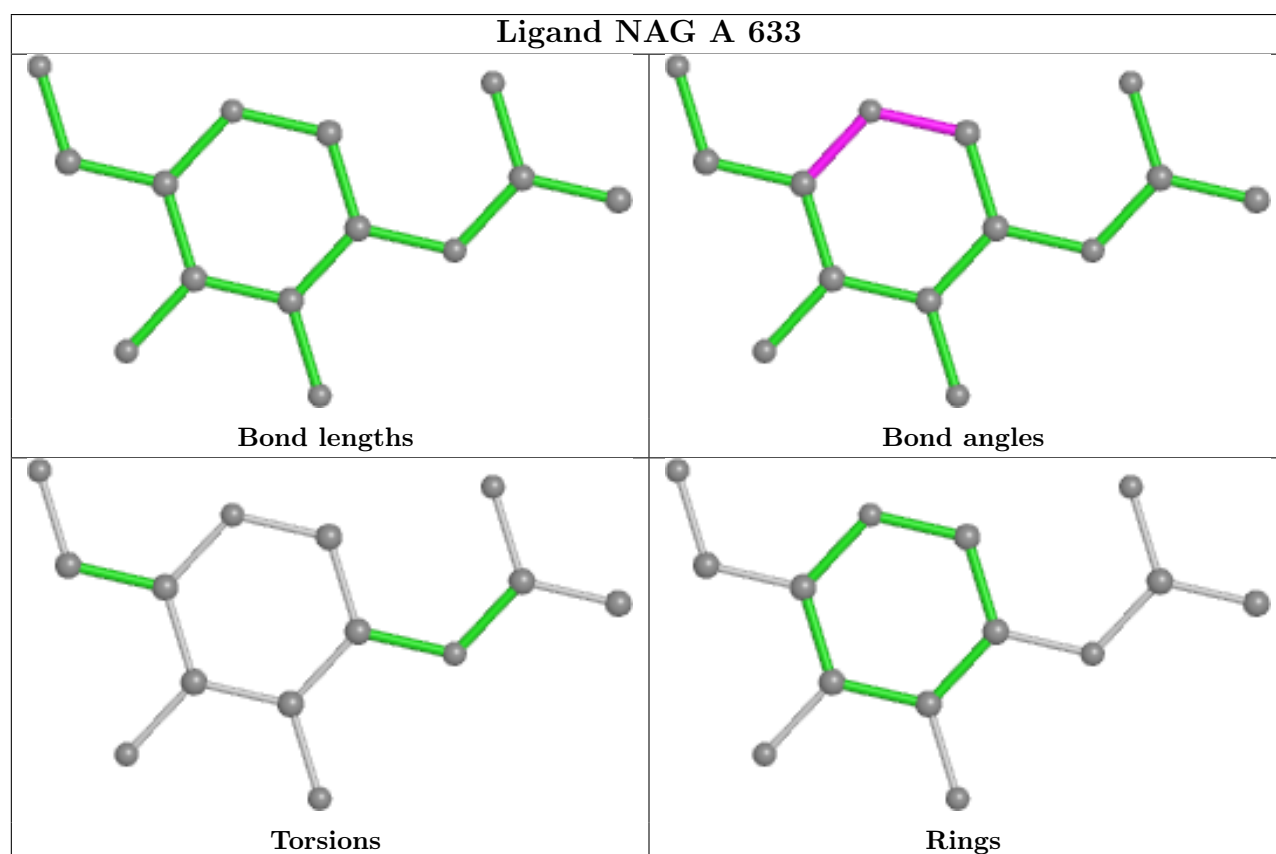
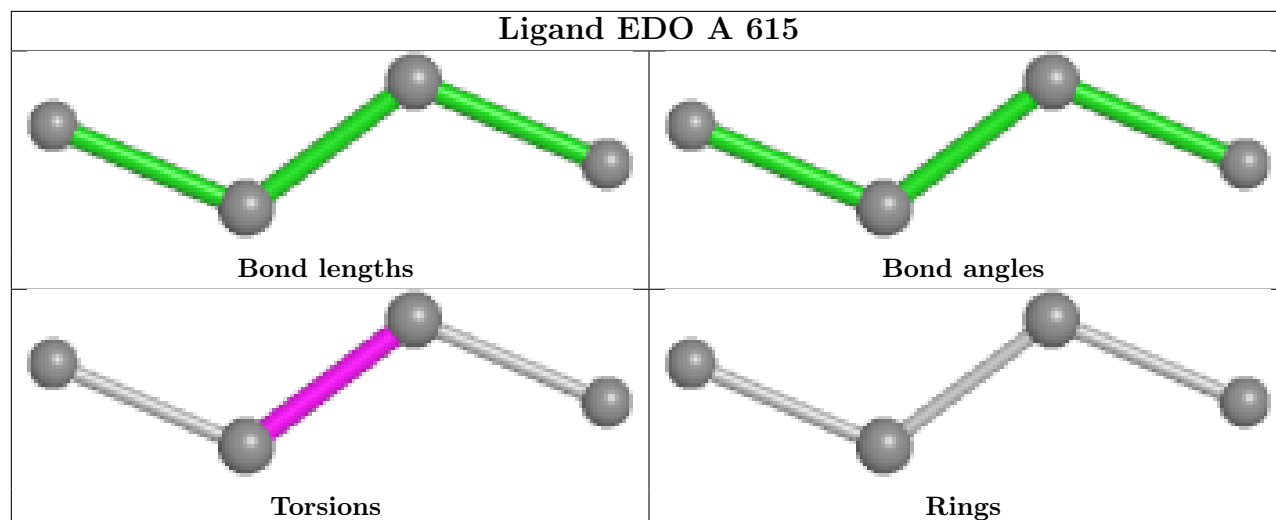

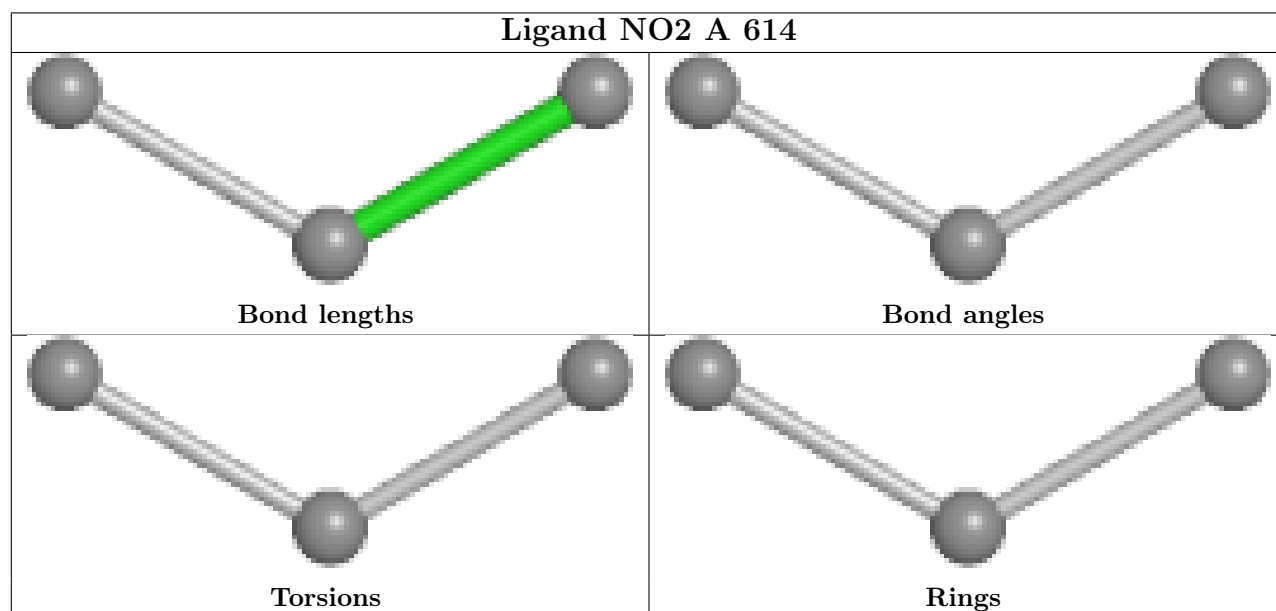
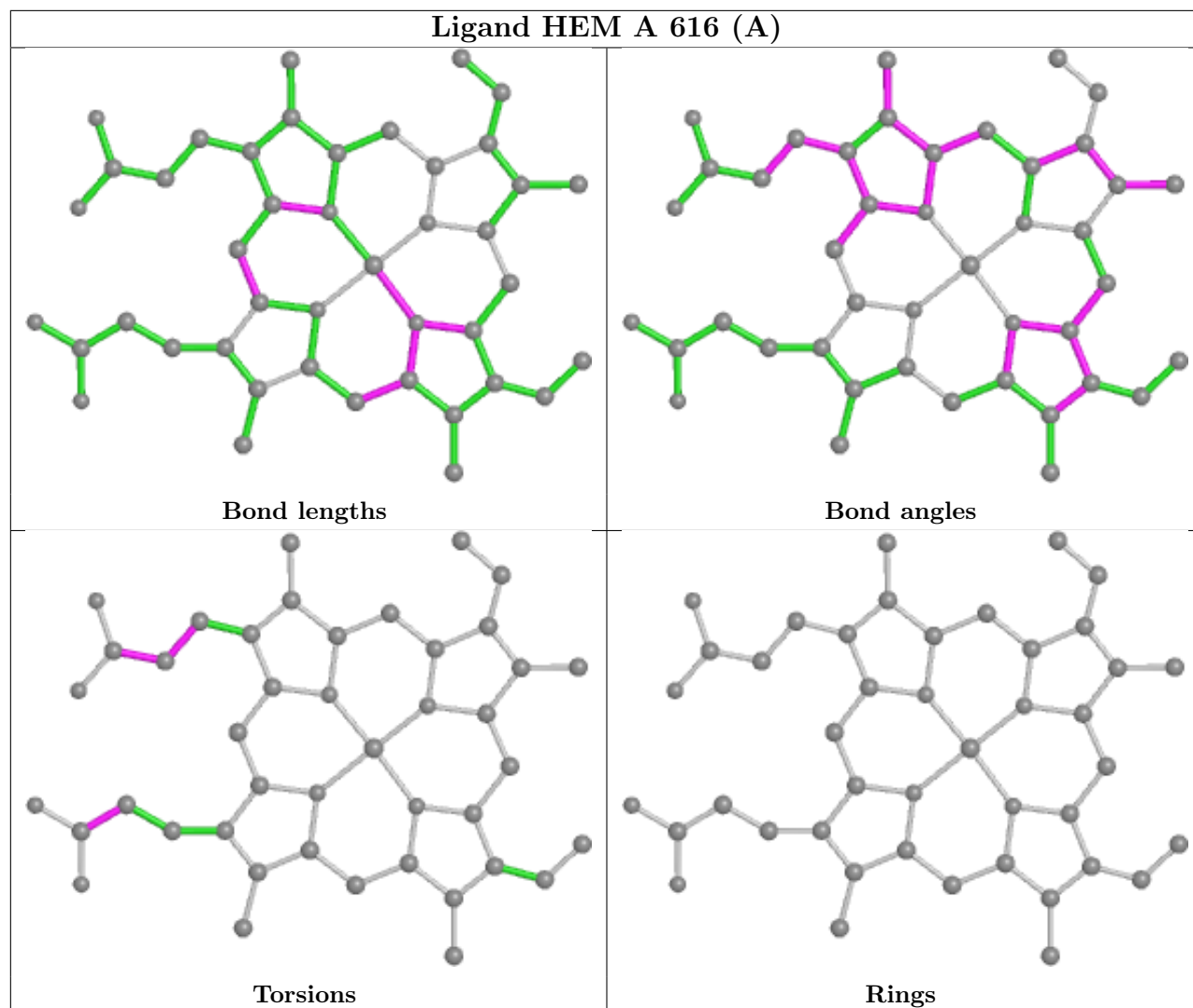

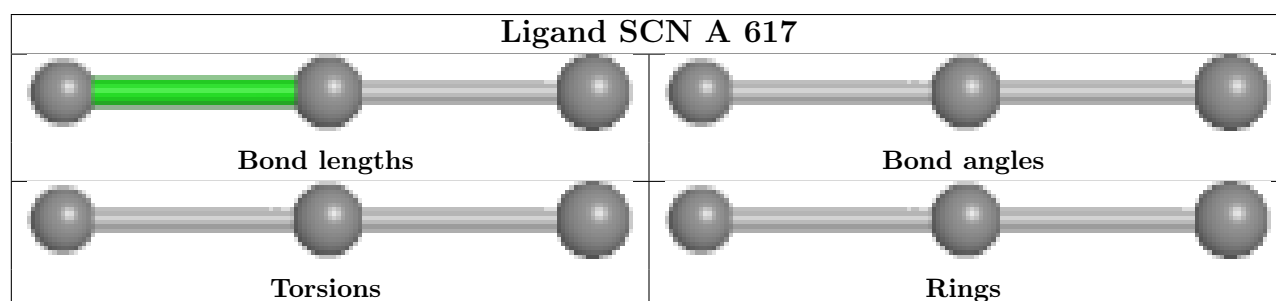
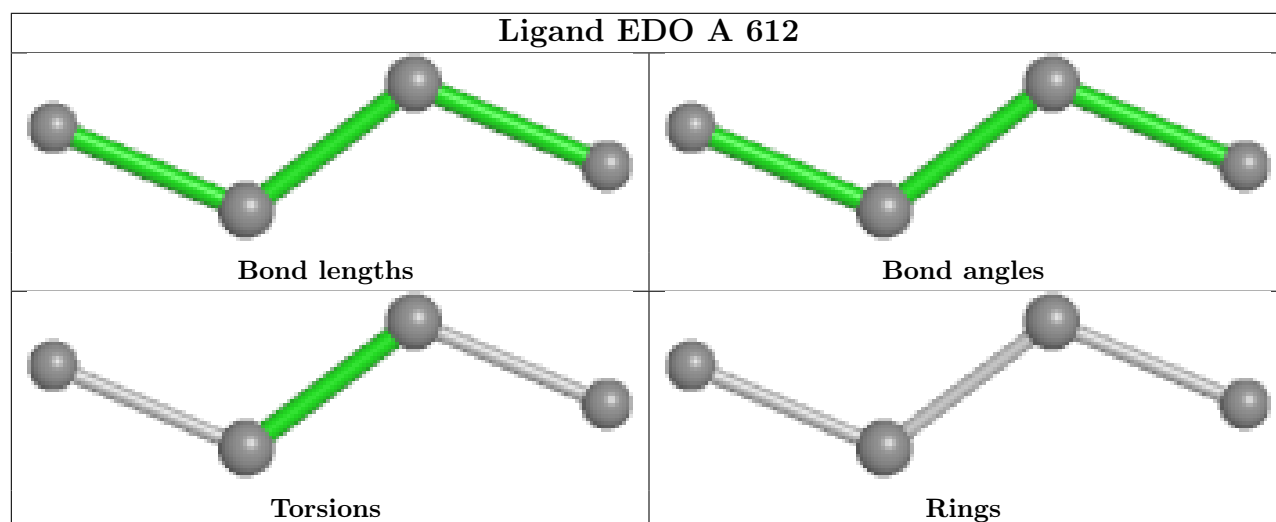
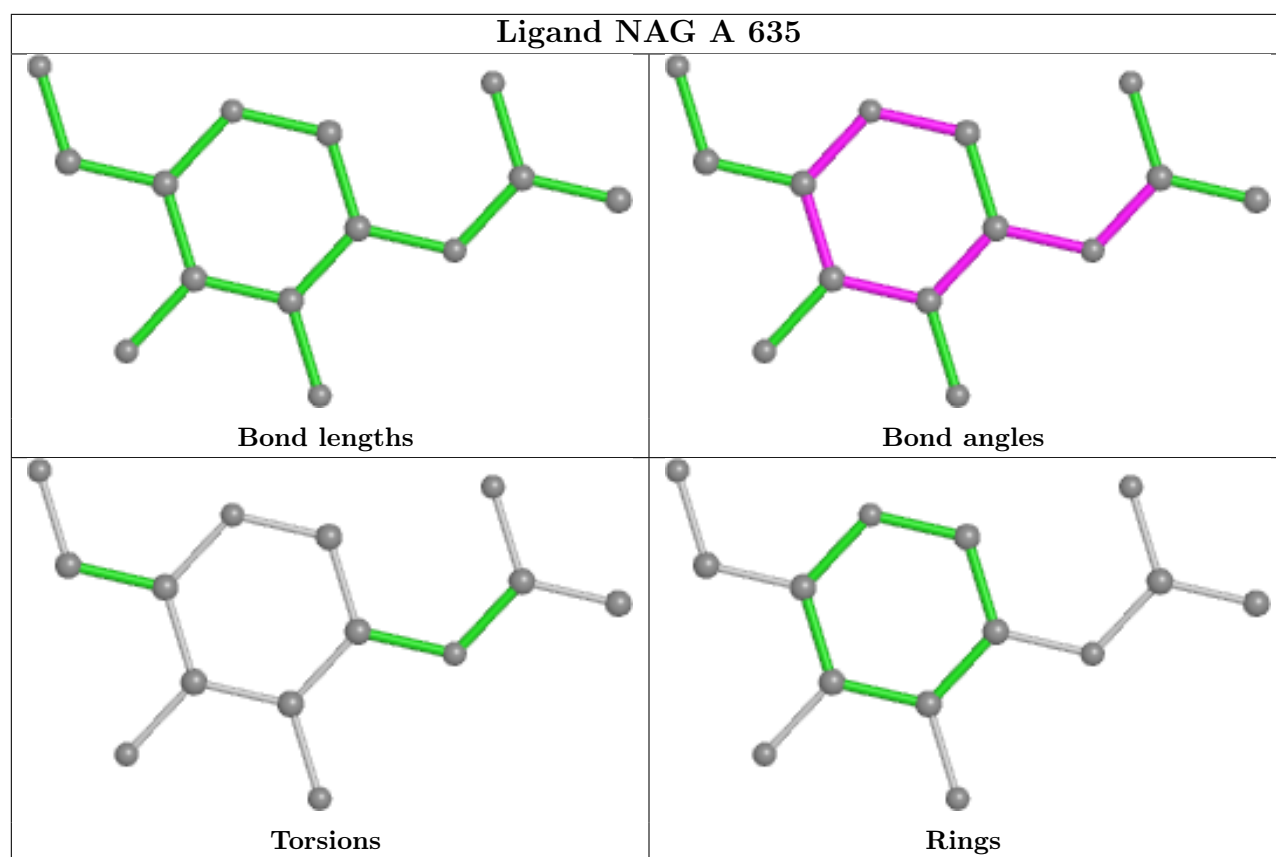

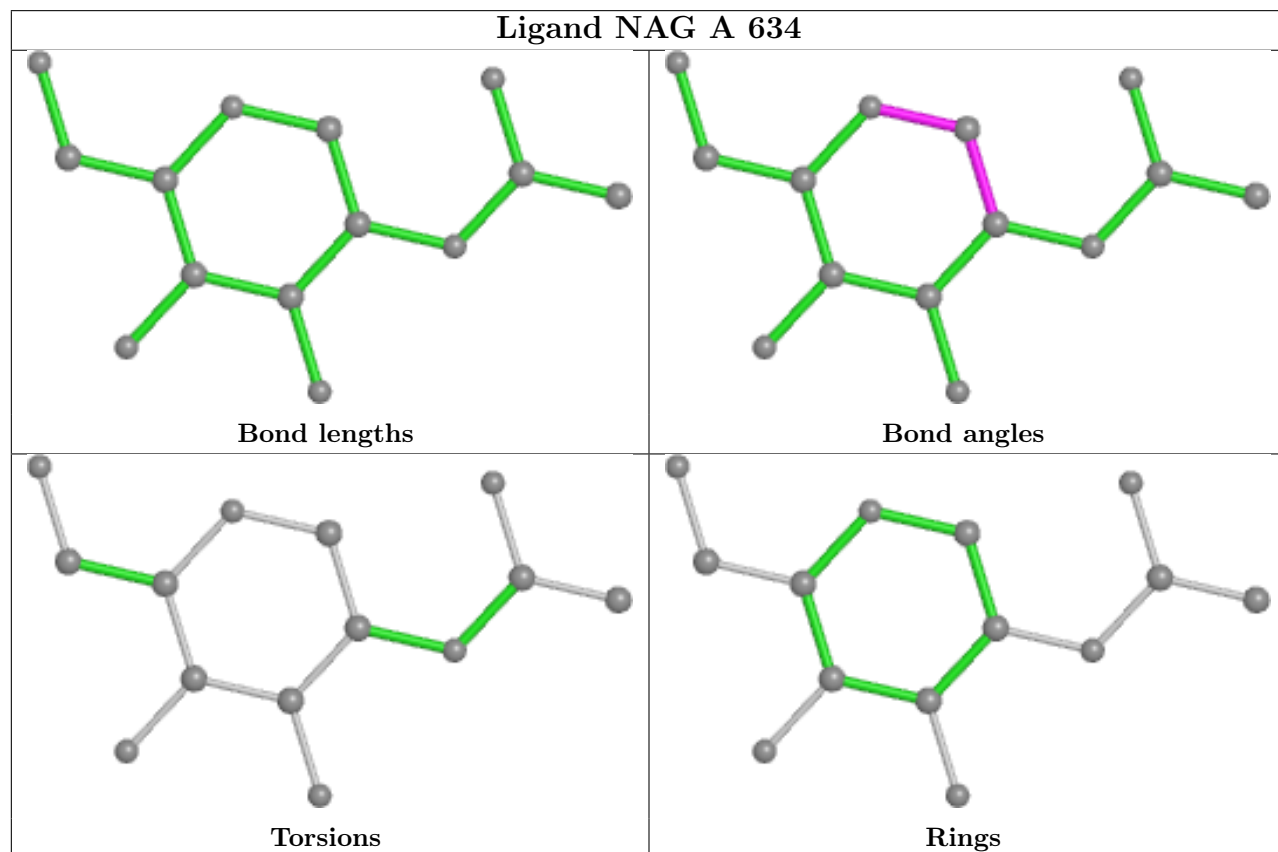
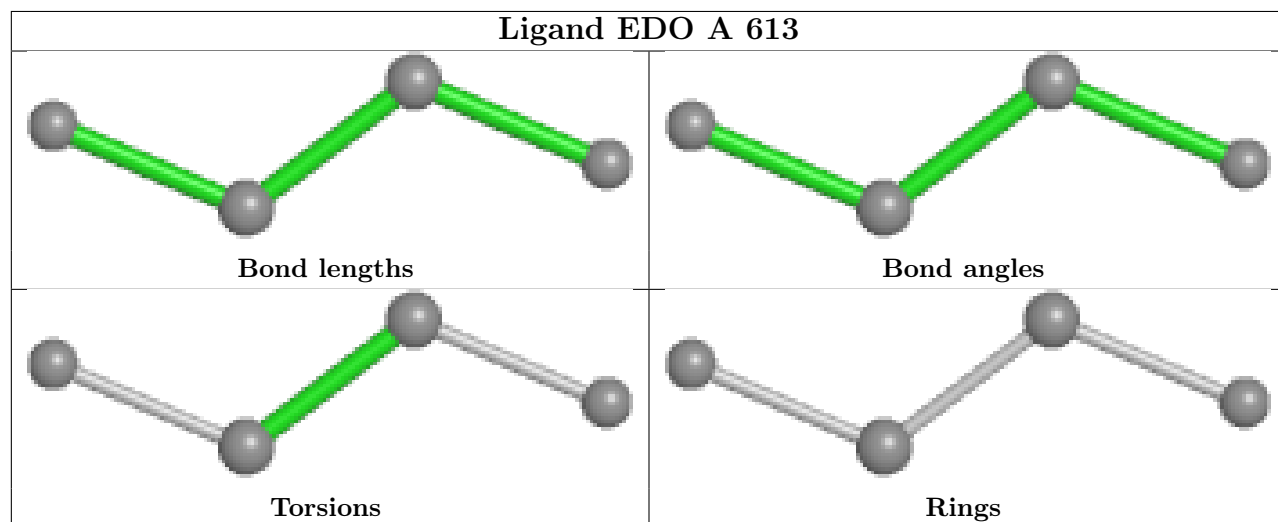
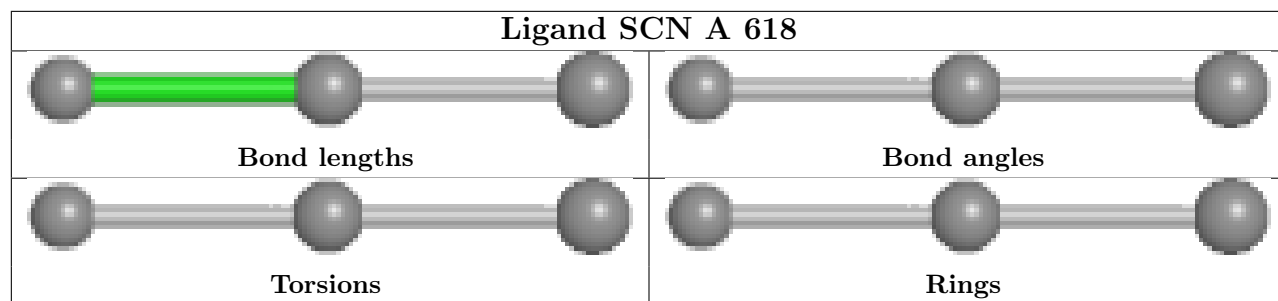

## 5.7 Other polymers [i](#)

There are no such residues in this entry.

## 5.8 Polymer linkage issues [i](#)

There are no chain breaks in this entry.

## 6 Fit of model and data [i](#)

### 6.1 Protein, DNA and RNA chains [i](#)

In the following table, the column labelled ‘#RSRZ> 2’ contains the number (and percentage) of RSRZ outliers, followed by percent RSRZ outliers for the chain as percentile scores relative to all X-ray entries and entries of similar resolution. The OWAB column contains the minimum, median, 95<sup>th</sup> percentile and maximum values of the occupancy-weighted average B-factor per residue. The column labelled ‘Q< 0.9’ lists the number of (and percentage) of residues with an average occupancy less than 0.9.

Mol	Chain	Analysed	<RSRZ>	#RSRZ>2	OWAB(Å <sup>2</sup> )	Q<0.9
1	A	595/595 (100%)	0.83	80 (13%) <b>3</b> <b>3</b>	12, 30, 81, 153	0

The worst 5 of 80 RSRZ outliers are listed below:

Mol	Chain	Res	Type	RSRZ
1	A	595	ASN	16.3
1	A	12	LEU	16.1
1	A	172	TYR	14.0
1	A	2	TRP	13.4
1	A	10	VAL	13.2

### 6.2 Non-standard residues in protein, DNA, RNA chains [i](#)

There are no non-standard protein/DNA/RNA residues in this entry.

### 6.3 Carbohydrates [i](#)

In the following table, the Atoms column lists the number of modelled atoms in the group and the number defined in the chemical component dictionary. The B-factors column lists the minimum, median, 95<sup>th</sup> percentile and maximum values of B factors of atoms in the group. The column labelled ‘Q< 0.9’ lists the number of atoms with occupancy less than 0.9.

Mol	Type	Chain	Res	Atoms	RSCC	RSR	B-factors(Å <sup>2</sup> )	Q<0.9
2	NAG	B	1	14/15	0.71	0.19	38,56,60,66	0
2	NAG	B	2	14/15	0.74	0.26	65,74,79,83	0

The following is a graphical depiction of the model fit to experimental electron density for oligosaccharide. Each fit is shown from different orientation to approximate a three-dimensional view.



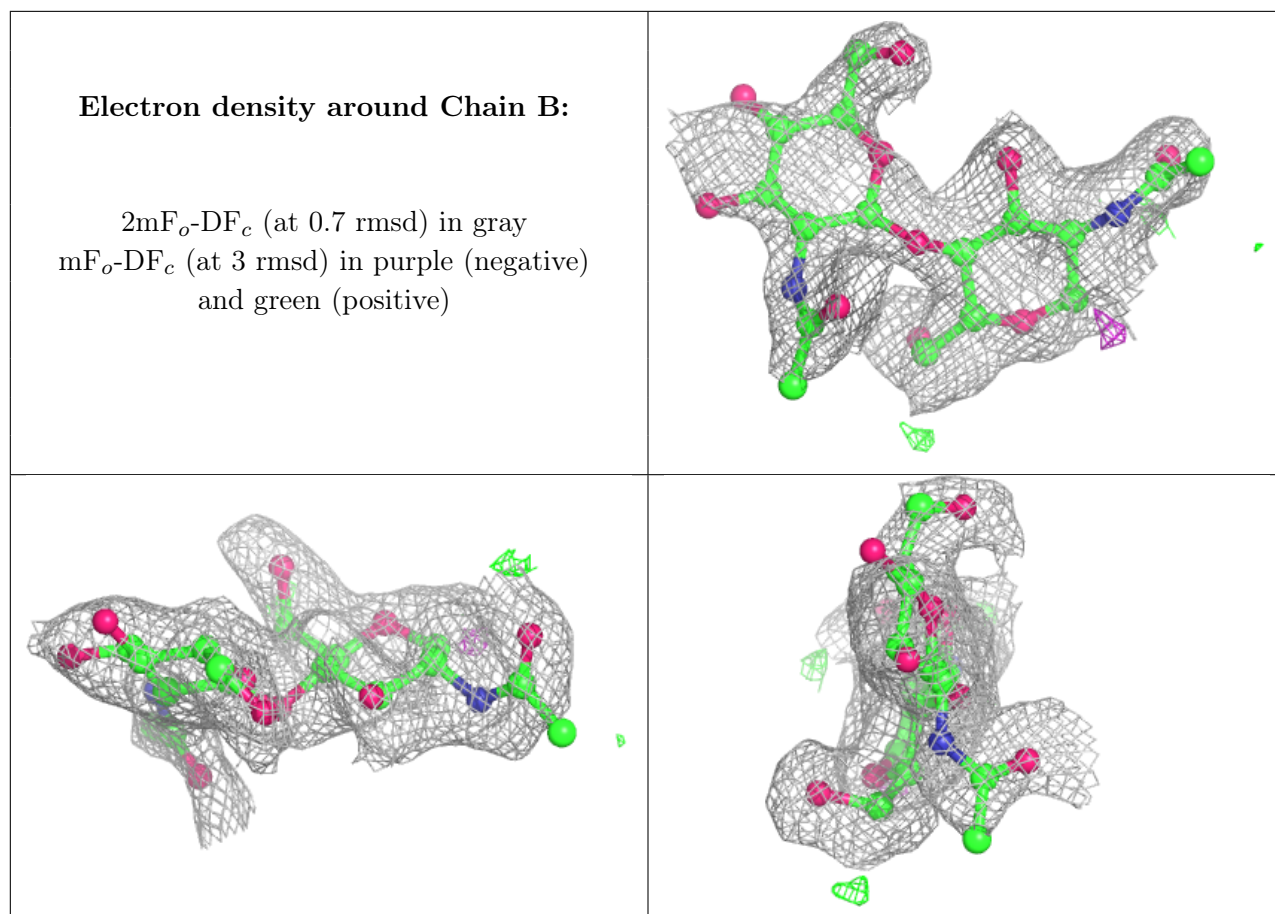

## 6.4 Ligands [i](#)

In the following table, the Atoms column lists the number of modelled atoms in the group and the number defined in the chemical component dictionary. The B-factors column lists the minimum, median, 95<sup>th</sup> percentile and maximum values of B factors of atoms in the group. The column labelled 'Q<0.9' lists the number of atoms with occupancy less than 0.9.

Mol	Type	Chain	Res	Atoms	RSCC	RSR	B-factors(Å <sup>2</sup> )	Q<0.9
10	NAG	A	633	14/15	0.66	0.30	51,61,70,72	0
10	NAG	A	635	14/15	0.81	0.16	48,58,64,64	0
6	EDO	A	612	4/4	0.83	0.18	24,24,27,30	0
10	NAG	A	634	14/15	0.89	0.10	34,38,40,42	0
6	EDO	A	613	4/4	0.90	0.22	40,48,50,50	0
5	SCN	A	611	3/3	0.90	0.10	47,47,54,54	0
6	EDO	A	615	4/4	0.92	0.13	31,31,33,35	0
4	IOD	A	609	1/1	0.95	0.04	50,50,50,50	1
9	ZN	A	632[B]	1/1	0.96	0.05	48,48,48,48	1
4	IOD	A	629	1/1	0.96	0.07	50,50,50,50	1
7	NO2	A	614	3/3	0.96	0.15	14,14,16,18	3
9	ZN	A	632[A]	1/1	0.96	0.05	40,40,40,40	1

*Continued on next page...*

Continued from previous page...

Mol	Type	Chain	Res	Atoms	RSCC	RSR	B-factors(Å <sup>2</sup> )	Q<0.9
4	IOD	A	631[B]	1/1	0.97	0.08	41,41,41,41	1
4	IOD	A	605	1/1	0.97	0.03	50,50,50,50	1
5	SCN	A	617	3/3	0.97	0.08	40,40,41,49	0
4	IOD	A	604[A]	1/1	0.97	0.07	33,33,33,33	1
4	IOD	A	604[B]	1/1	0.97	0.07	46,46,46,46	1
4	IOD	A	631[A]	1/1	0.97	0.08	47,47,47,47	1
4	IOD	A	624	1/1	0.98	0.05	46,46,46,46	1
4	IOD	A	626[A]	1/1	0.98	0.07	46,46,46,46	1
4	IOD	A	626[B]	1/1	0.98	0.07	55,55,55,55	1
4	IOD	A	608[B]	1/1	0.98	0.04	26,26,26,26	1
8	HEM	A	616[A]	43/43	0.98	0.14	12,14,17,20	5
8	HEM	A	616[B]	43/43	0.98	0.14	12,14,19,20	5
4	IOD	A	608[A]	1/1	0.98	0.04	24,24,24,24	1
4	IOD	A	610	1/1	0.98	0.06	33,33,33,33	1
4	IOD	A	620[A]	1/1	0.98	0.03	28,28,28,28	1
4	IOD	A	620[B]	1/1	0.98	0.03	30,30,30,30	1
5	SCN	A	618	3/3	0.98	0.08	22,22,23,26	3
4	IOD	A	630	1/1	0.99	0.03	35,35,35,35	1
3	CA	A	601	1/1	0.99	0.05	17,17,17,17	0
4	IOD	A	622[A]	1/1	0.99	0.04	23,23,23,23	1
4	IOD	A	622[B]	1/1	0.99	0.04	39,39,39,39	1
4	IOD	A	622[C]	1/1	0.99	0.04	29,29,29,29	1
4	IOD	A	622[D]	1/1	0.99	0.04	30,30,30,30	1
4	IOD	A	603[A]	1/1	0.99	0.04	24,24,24,24	1
4	IOD	A	625	1/1	0.99	0.05	33,33,33,33	1
4	IOD	A	603[B]	1/1	0.99	0.04	25,25,25,25	1
4	IOD	A	606[A]	1/1	0.99	0.05	23,23,23,23	1
4	IOD	A	627[A]	1/1	0.99	0.04	21,21,21,21	1
4	IOD	A	627[B]	1/1	0.99	0.04	19,19,19,19	1
4	IOD	A	627[C]	1/1	0.99	0.04	25,25,25,25	1
4	IOD	A	627[D]	1/1	0.99	0.04	20,20,20,20	1
4	IOD	A	628[A]	1/1	0.99	0.03	26,26,26,26	1
4	IOD	A	628[B]	1/1	0.99	0.03	42,42,42,42	1
4	IOD	A	606[B]	1/1	0.99	0.05	22,22,22,22	1
4	IOD	A	607	1/1	1.00	0.03	27,27,27,27	1
4	IOD	A	621	1/1	1.00	0.02	30,30,30,30	1
4	IOD	A	602[B]	1/1	1.00	0.04	32,32,32,32	1
4	IOD	A	619[A]	1/1	1.00	0.05	20,20,20,20	1
4	IOD	A	619[B]	1/1	1.00	0.05	17,17,17,17	1
4	IOD	A	602[A]	1/1	1.00	0.04	21,21,21,21	1
4	IOD	A	623	1/1	1.00	0.04	18,18,18,18	0

The following is a graphical depiction of the model fit to experimental electron density of all

instances of the Ligand of Interest. In addition, ligands with molecular weight > 250 and outliers as shown on the geometry validation Tables will also be included. Each fit is shown from different orientation to approximate a three-dimensional view.

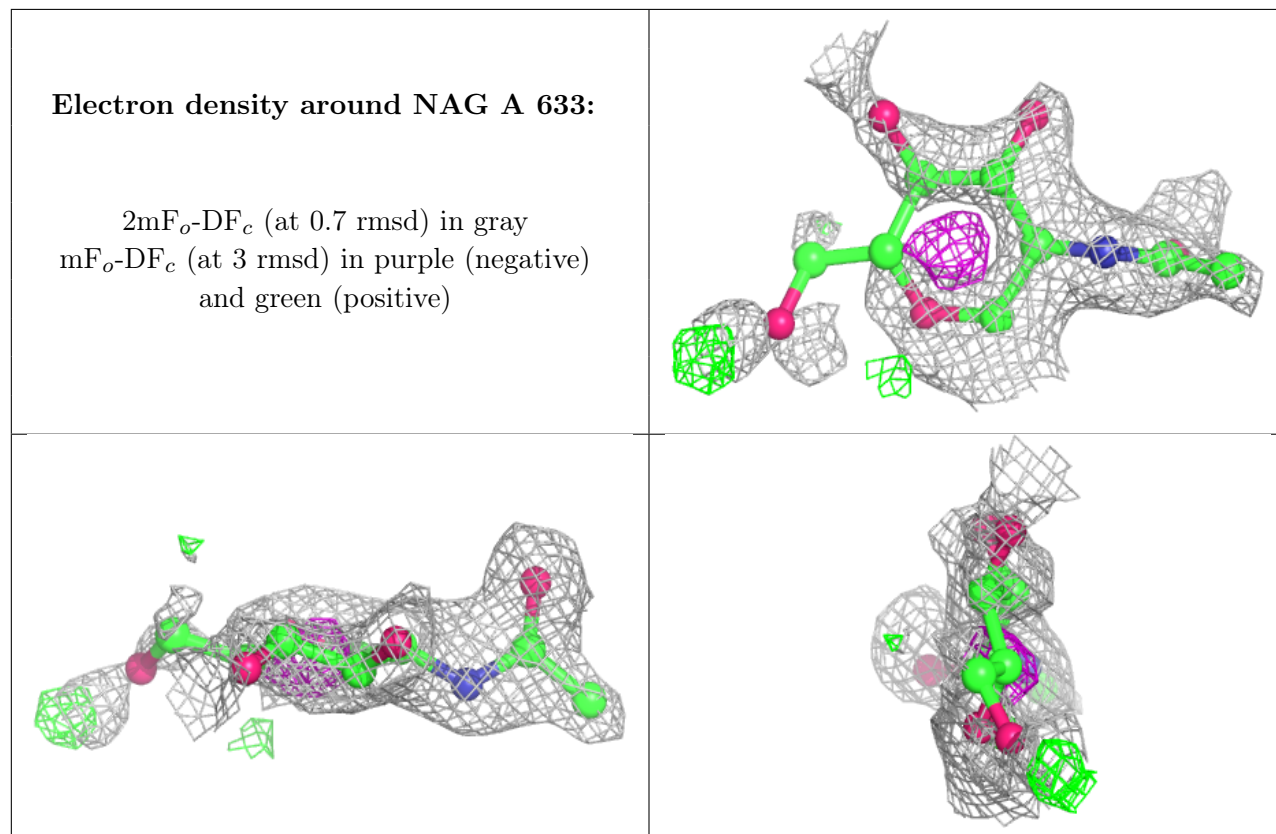

**Electron density around NAG A 635:**

$2mF_o-DF_c$  (at 0.7 rmsd) in gray  
 $mF_o-DF_c$  (at 3 rmsd) in purple (negative)  
and green (positive)

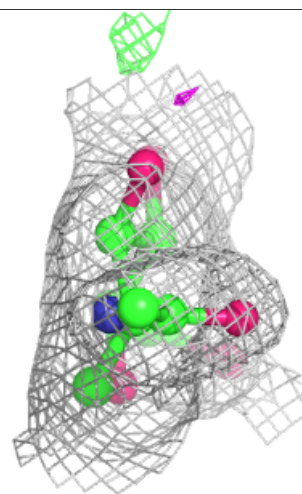
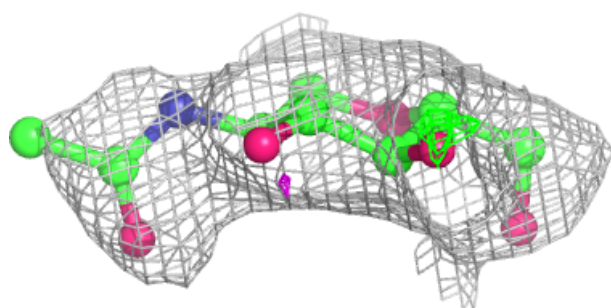
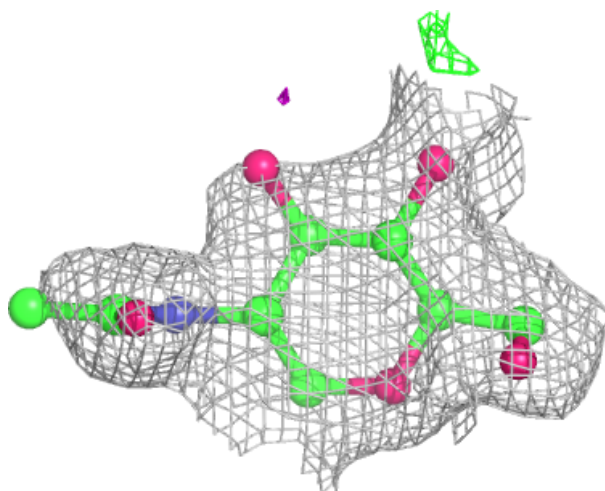

**Electron density around EDO A 612:**

$2mF_o-DF_c$  (at 0.7 rmsd) in gray  
 $mF_o-DF_c$  (at 3 rmsd) in purple (negative)  
and green (positive)

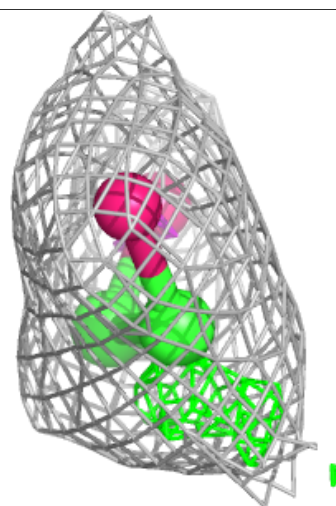
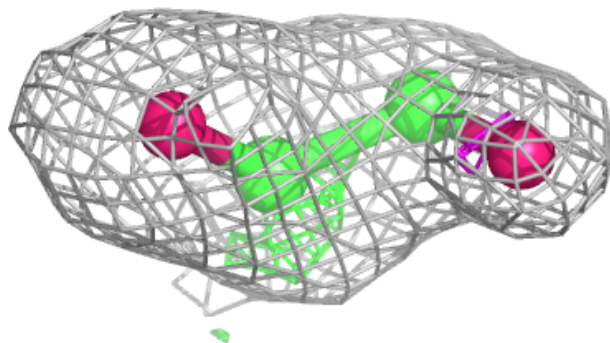
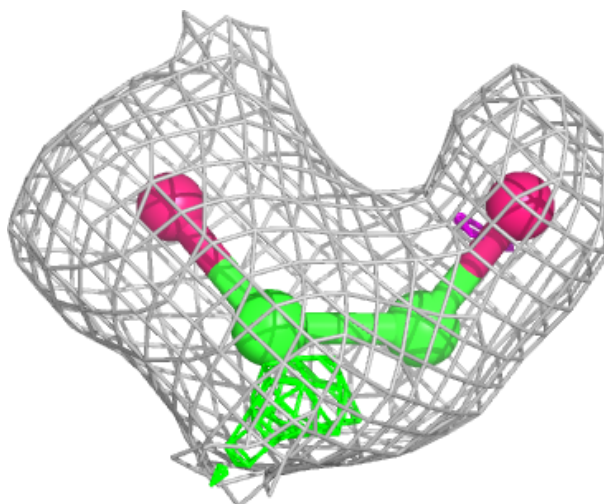

**Electron density around NAG A 634:**

$2mF_o-DF_c$  (at 0.7 rmsd) in gray  
 $mF_o-DF_c$  (at 3 rmsd) in purple (negative)  
and green (positive)

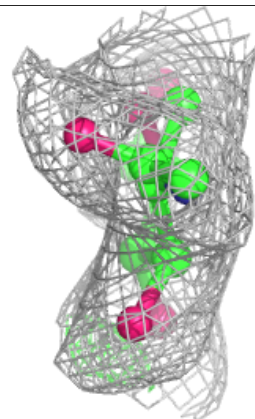
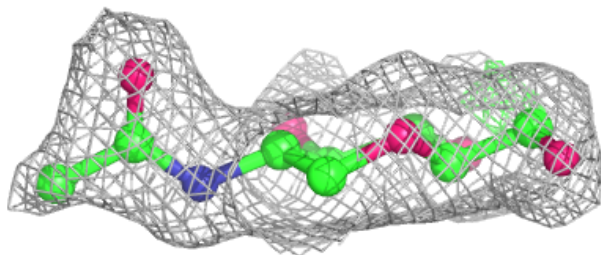
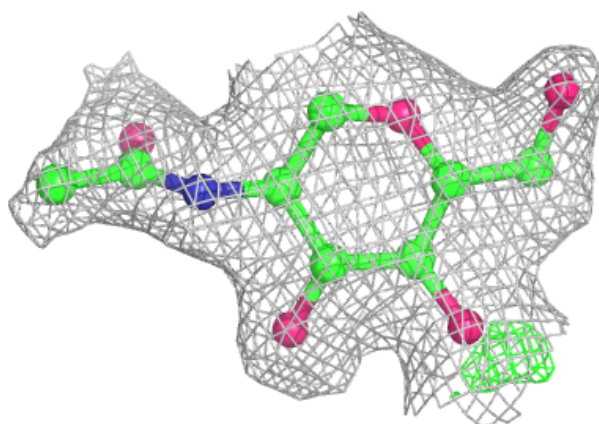

**Electron density around EDO A 613:**

$2mF_o-DF_c$  (at 0.7 rmsd) in gray  
 $mF_o-DF_c$  (at 3 rmsd) in purple (negative)  
and green (positive)

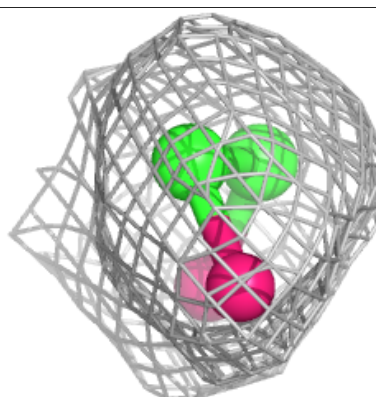
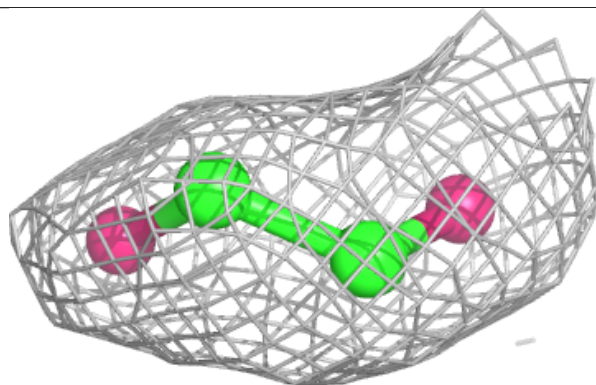
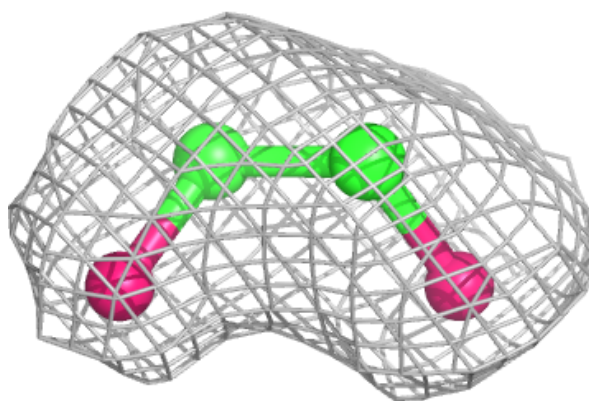
**Electron density around SCN A 611:**

$2mF_o-DF_c$  (at 0.7 rmsd) in gray  
 $mF_o-DF_c$  (at 3 rmsd) in purple (negative)  
and green (positive)

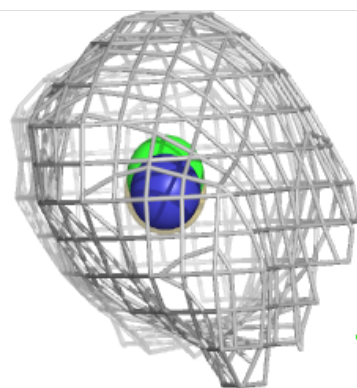
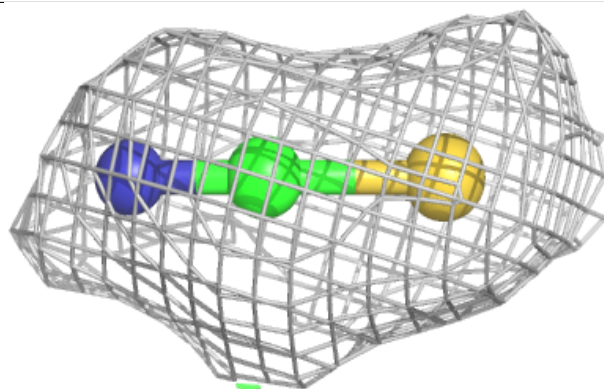
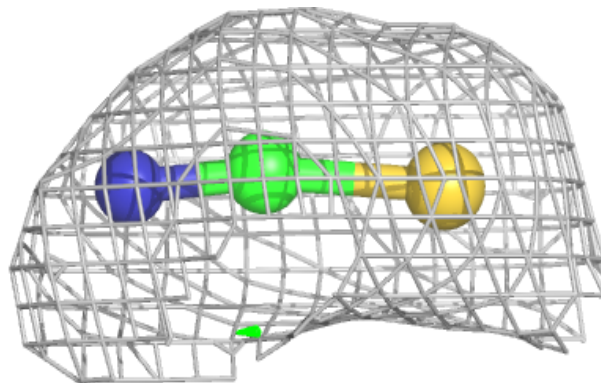

**Electron density around EDO A 615:**

$2mF_o-DF_c$  (at 0.7 rmsd) in gray  
 $mF_o-DF_c$  (at 3 rmsd) in purple (negative)  
and green (positive)

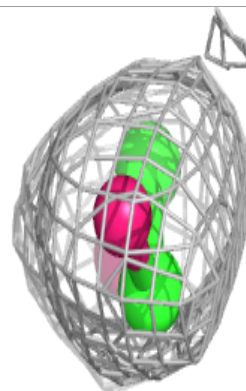
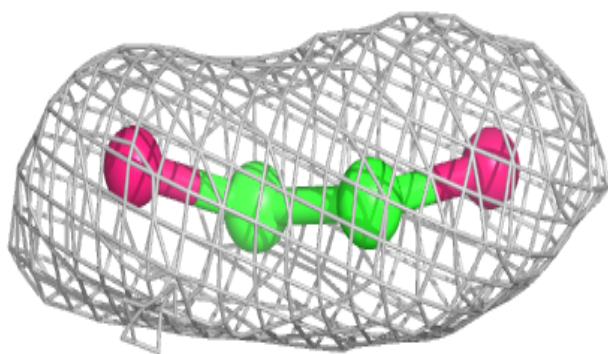
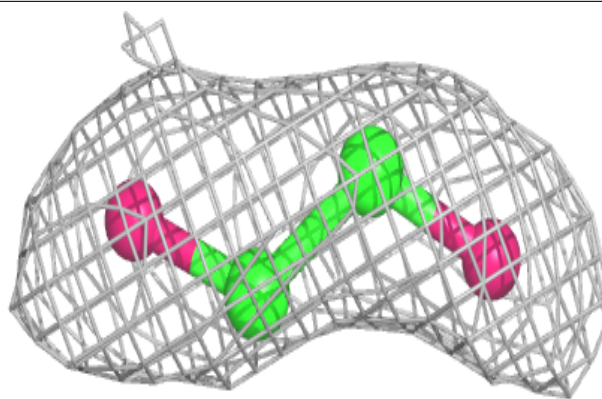



**Electron density around IOD A 609:**

$2mF_o-DF_c$  (at 0.7 rmsd) in gray  
 $mF_o-DF_c$  (at 3 rmsd) in purple (negative)  
and green (positive)

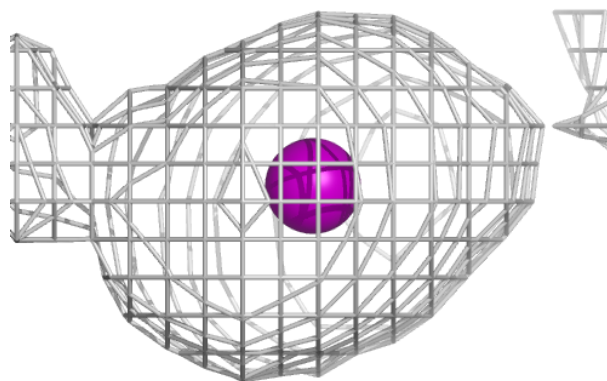
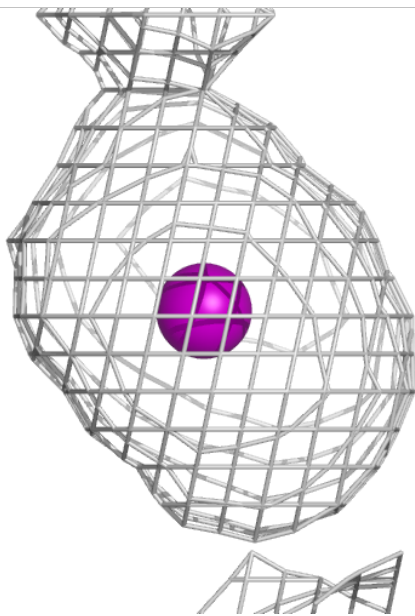
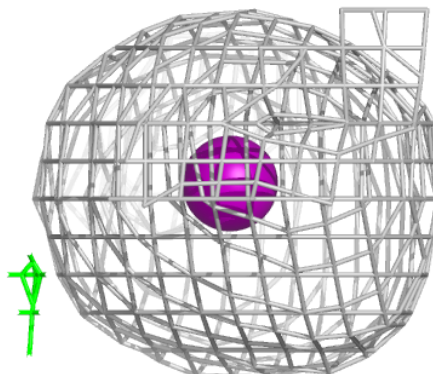

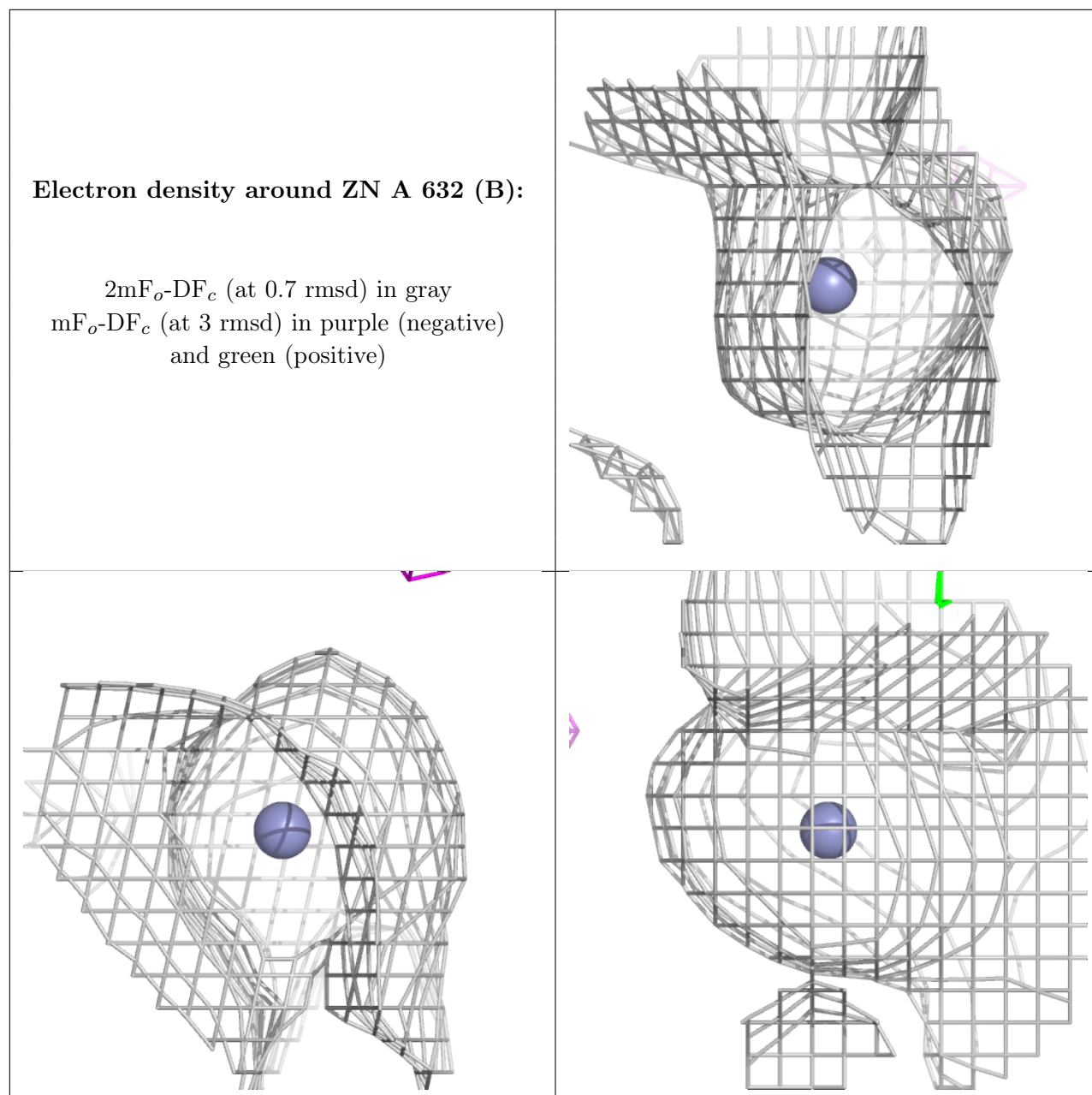

**Electron density around IOD A 629:**

$2mF_o-DF_c$  (at 0.7 rmsd) in gray  
 $mF_o-DF_c$  (at 3 rmsd) in purple (negative)  
and green (positive)

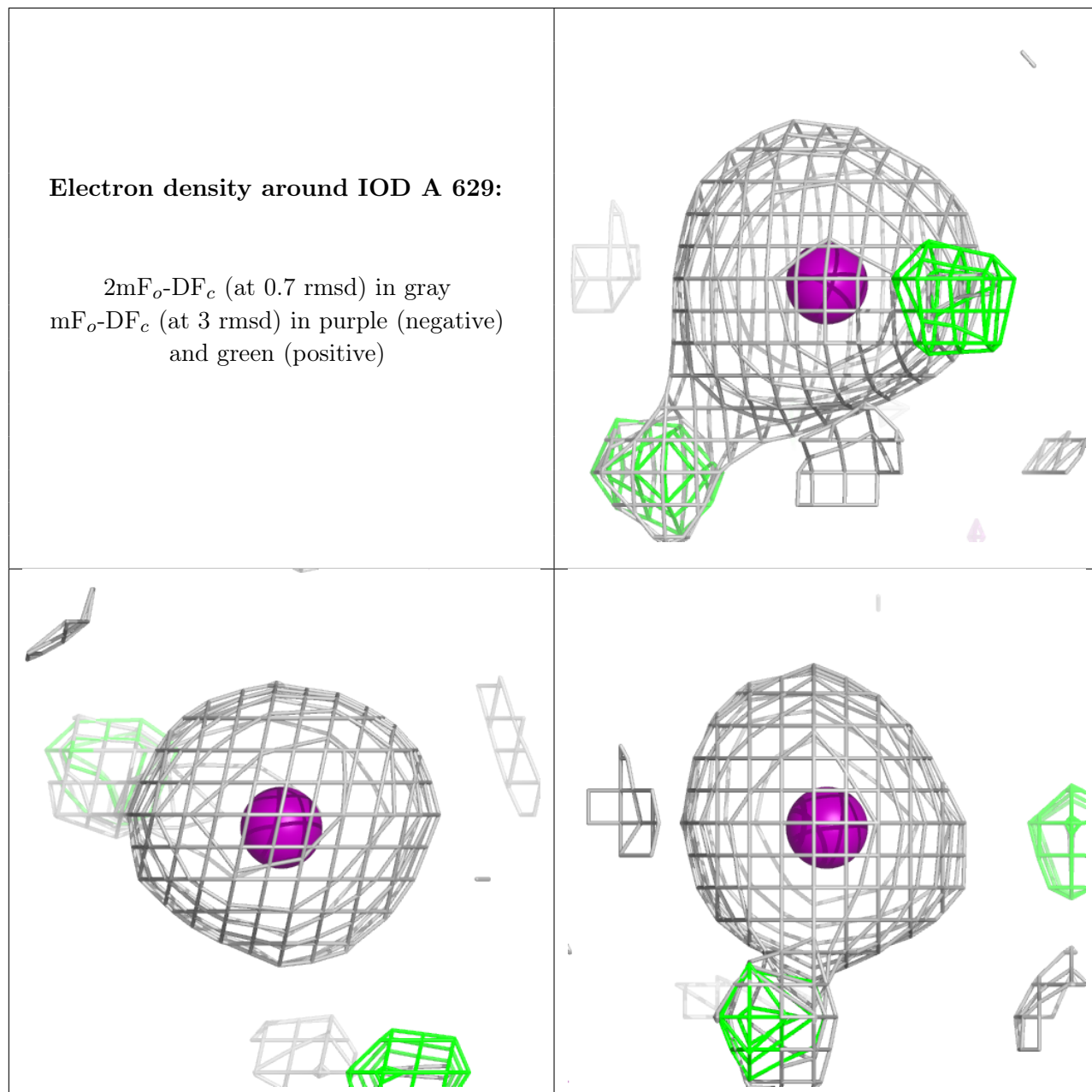

**Electron density around NO2 A 614:**

$2mF_o-DF_c$  (at 0.7 rmsd) in gray  
 $mF_o-DF_c$  (at 3 rmsd) in purple (negative)  
and green (positive)

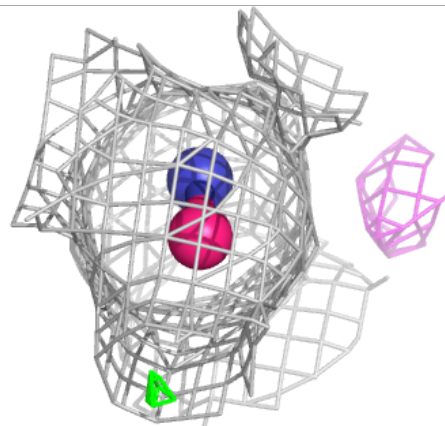
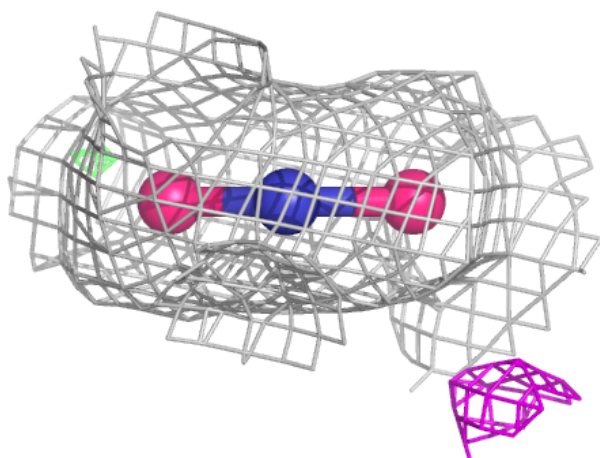
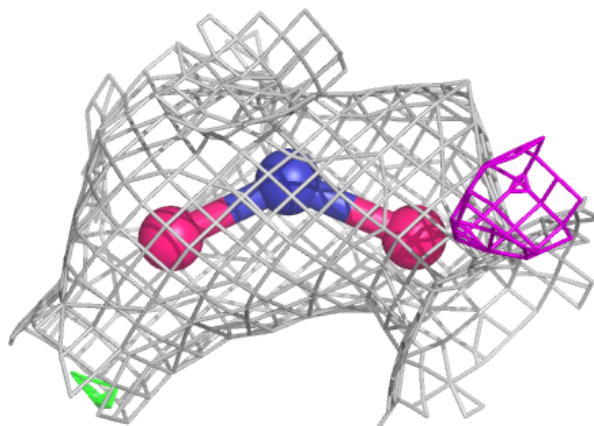

**Electron density around ZN A 632 (A):**

$2mF_o-DF_c$  (at 0.7 rmsd) in gray  
 $mF_o-DF_c$  (at 3 rmsd) in purple (negative)  
and green (positive)

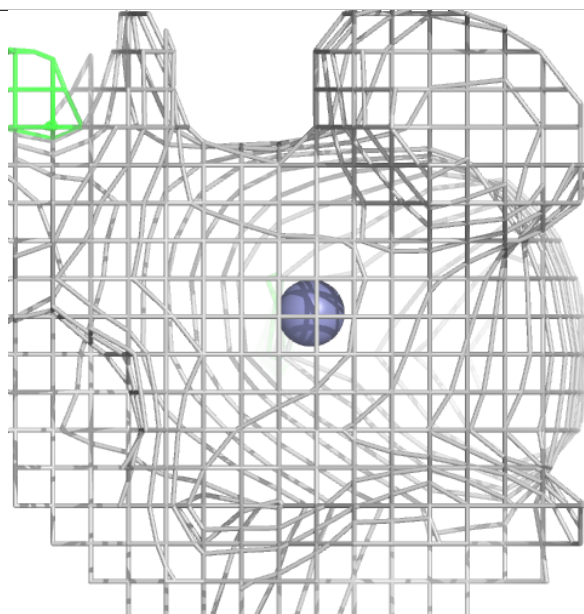
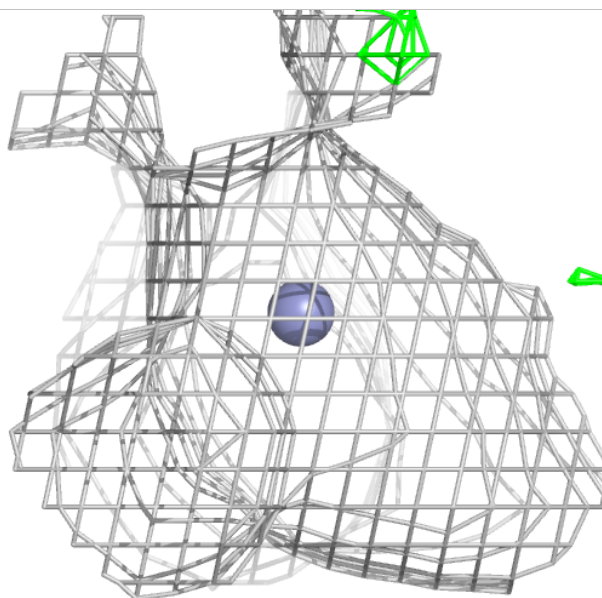
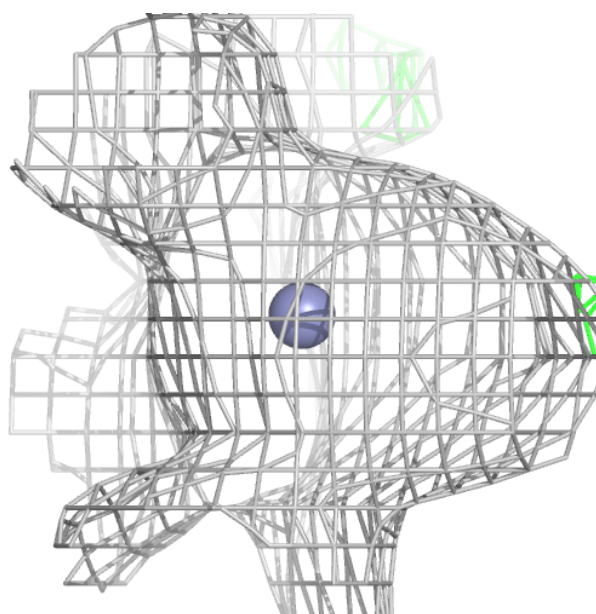

**Electron density around IOD A 631 (B):**

$2mF_o-DF_c$  (at 0.7 rmsd) in gray  
 $mF_o-DF_c$  (at 3 rmsd) in purple (negative)  
and green (positive)

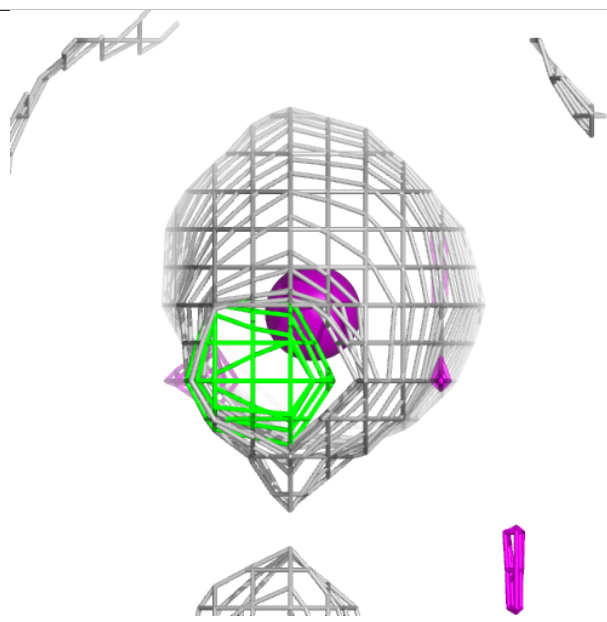
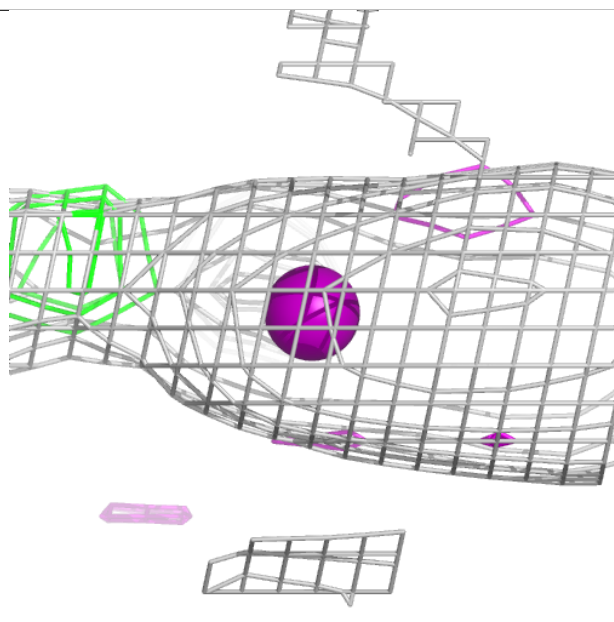
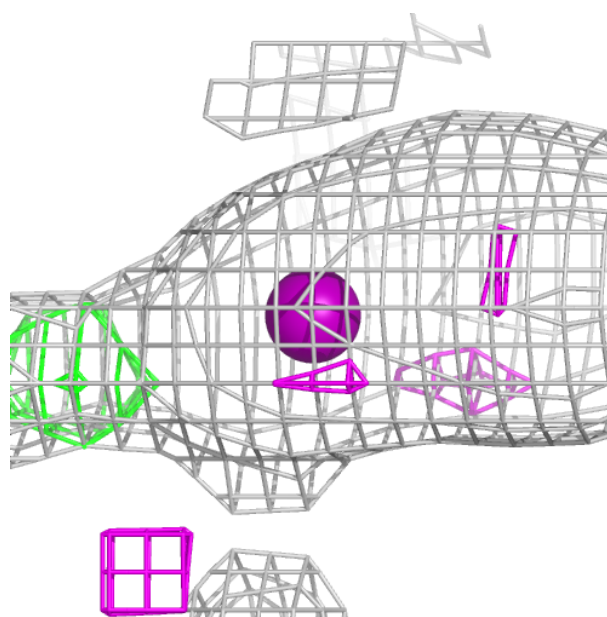

**Electron density around IOD A 605:**

$2mF_o-DF_c$  (at 0.7 rmsd) in gray  
 $mF_o-DF_c$  (at 3 rmsd) in purple (negative)  
and green (positive)

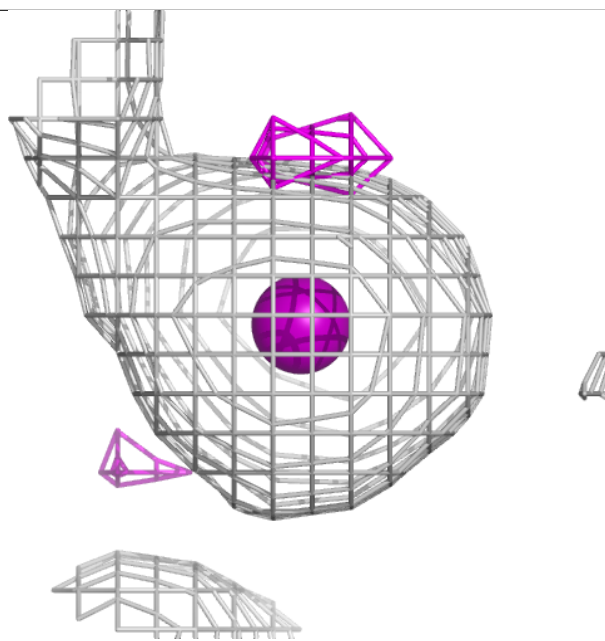
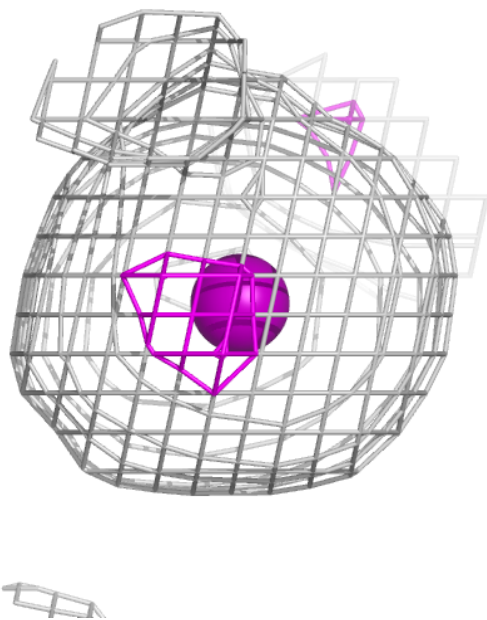
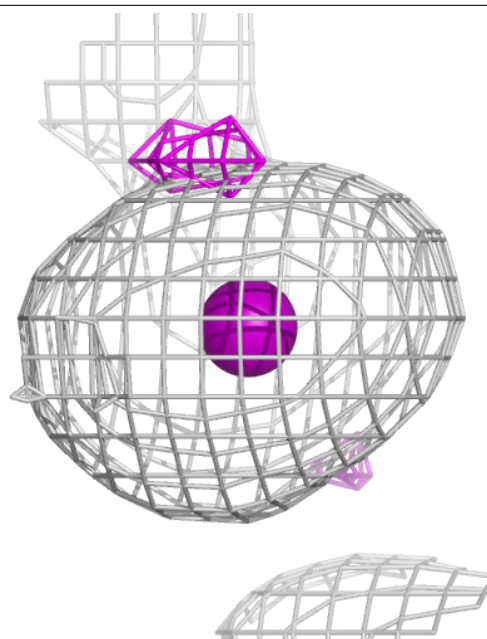

**Electron density around SCN A 617:**

$2mF_o-DF_c$  (at 0.7 rmsd) in gray  
 $mF_o-DF_c$  (at 3 rmsd) in purple (negative)  
and green (positive)

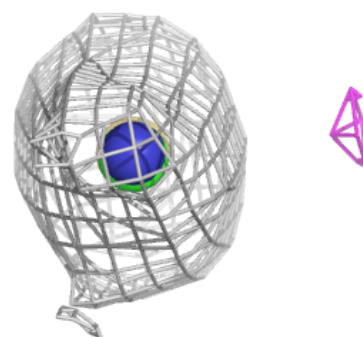
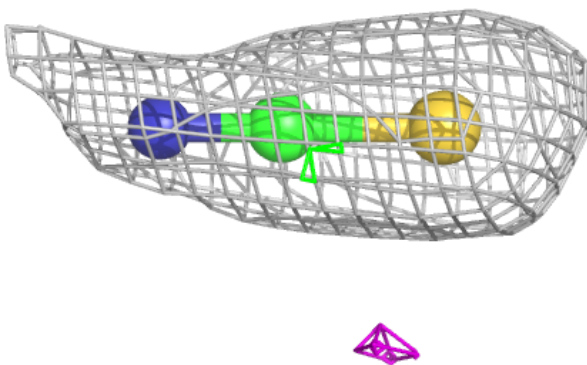
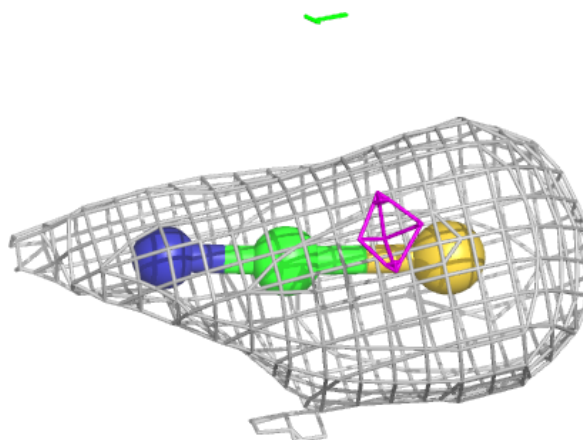



**Electron density around IOD A 604 (A):**

$2mF_o-DF_c$  (at 0.7 rmsd) in gray  
 $mF_o-DF_c$  (at 3 rmsd) in purple (negative)  
and green (positive)

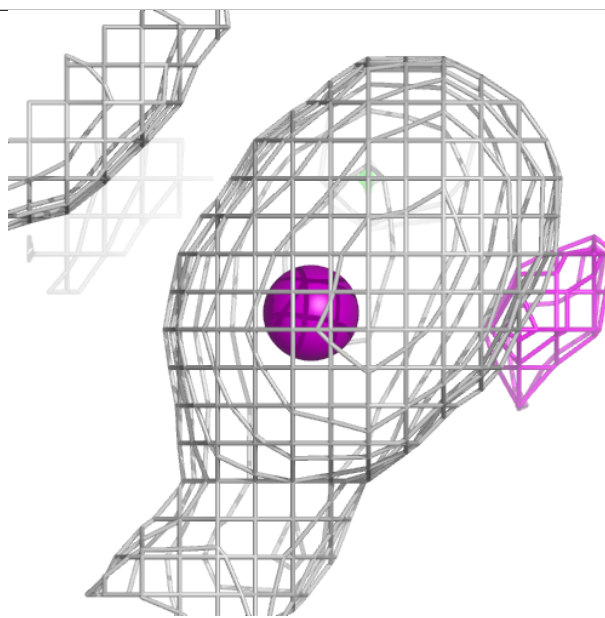
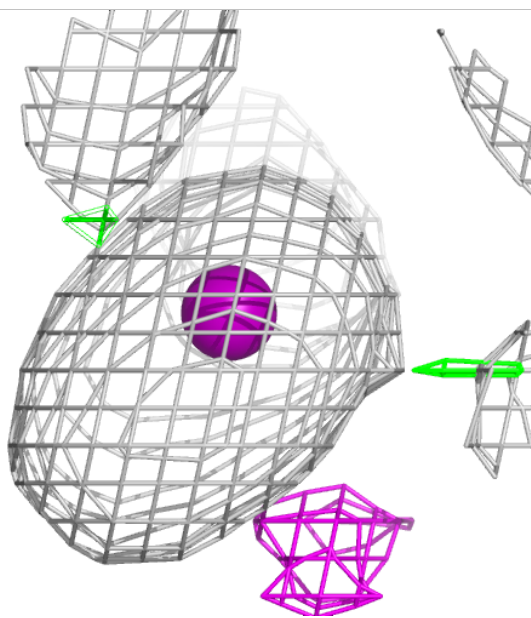
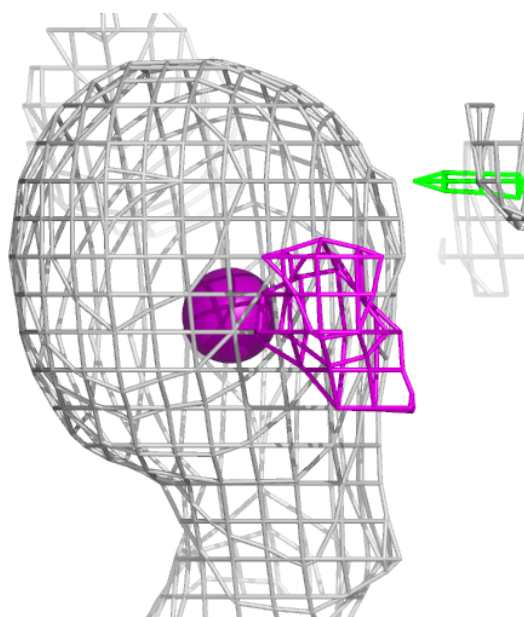

**Electron density around IOD A 604 (B):**

$2mF_o-DF_c$  (at 0.7 rmsd) in gray  
 $mF_o-DF_c$  (at 3 rmsd) in purple (negative)  
and green (positive)

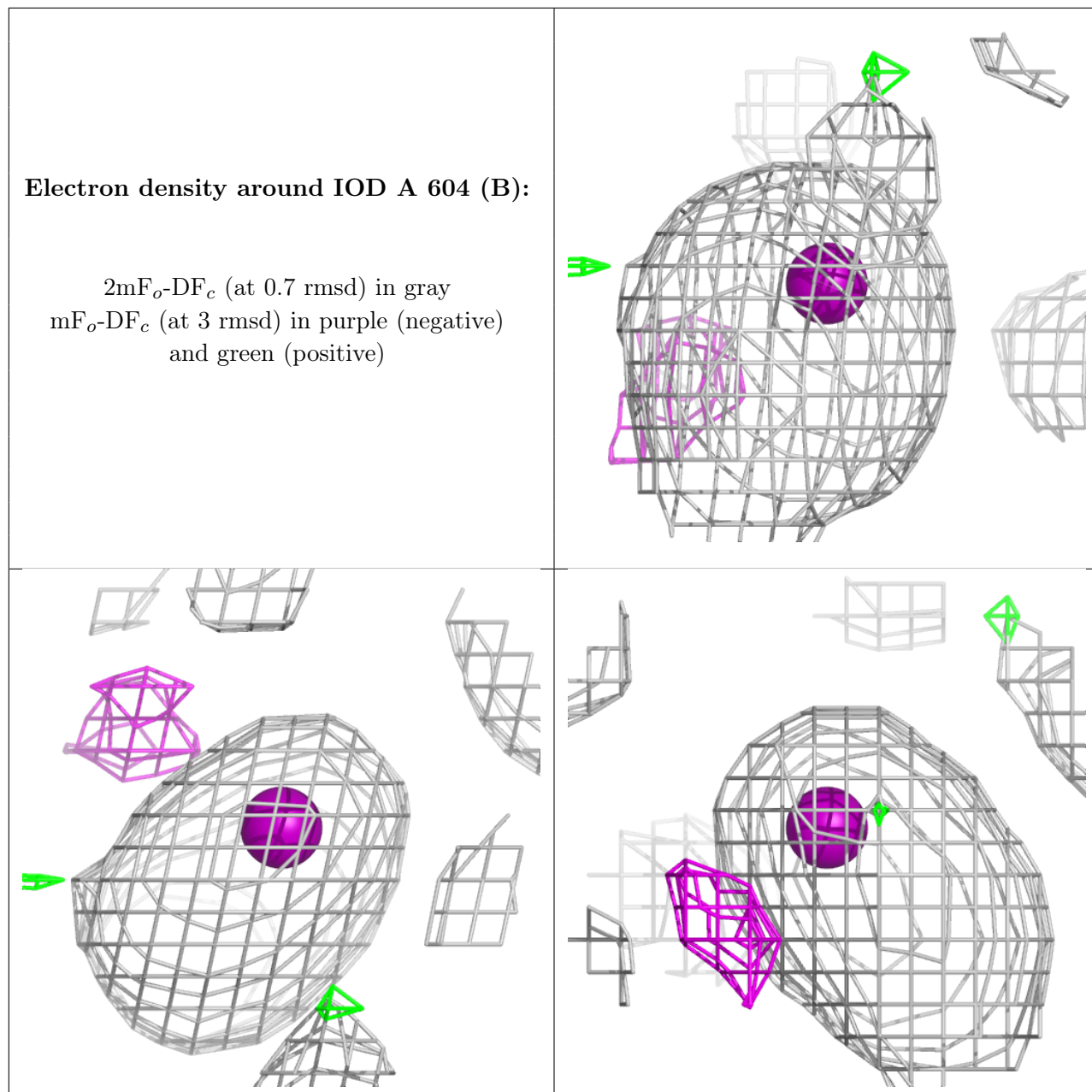

**Electron density around IOD A 631 (A):**

$2mF_o-DF_c$  (at 0.7 rmsd) in gray  
 $mF_o-DF_c$  (at 3 rmsd) in purple (negative)  
and green (positive)

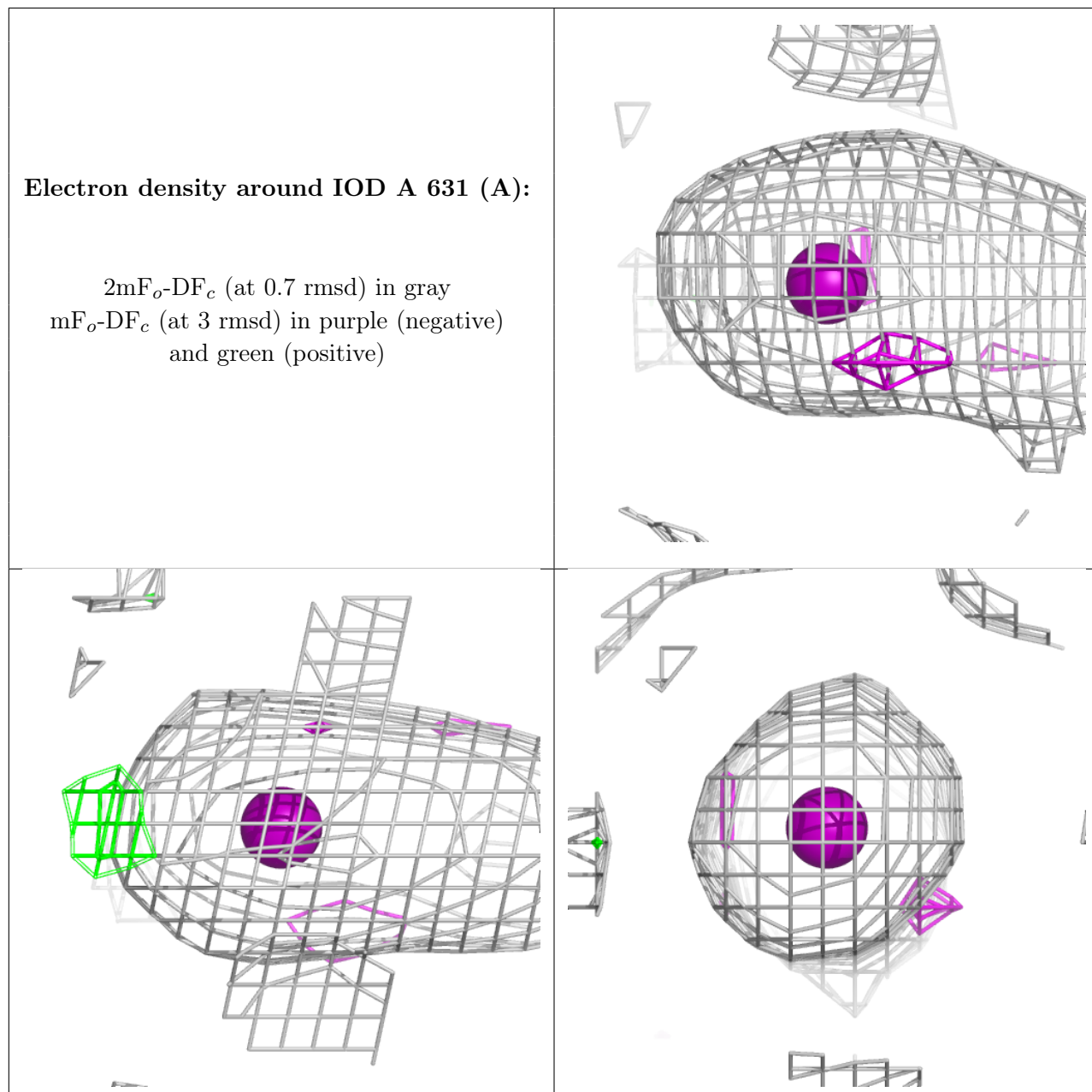

**Electron density around IOD A 624:**

$2mF_o-DF_c$  (at 0.7 rmsd) in gray  
 $mF_o-DF_c$  (at 3 rmsd) in purple (negative)  
and green (positive)

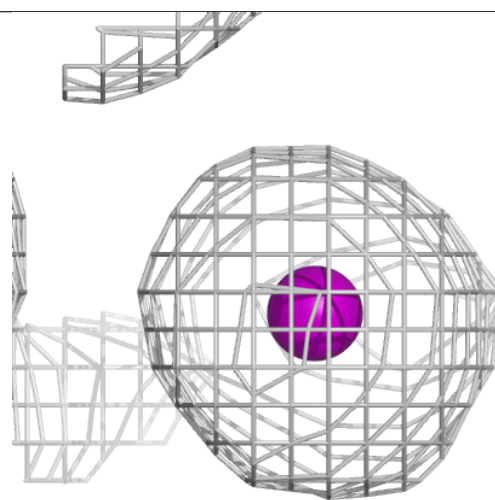
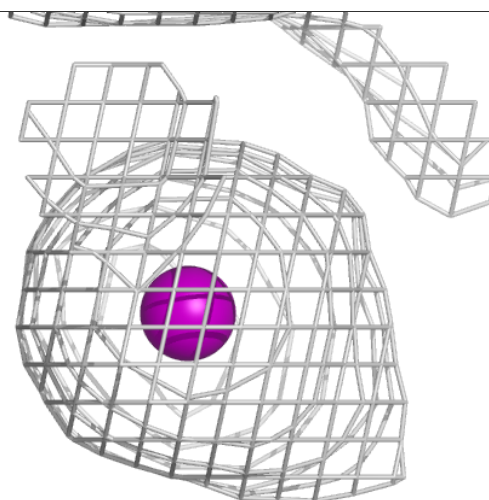
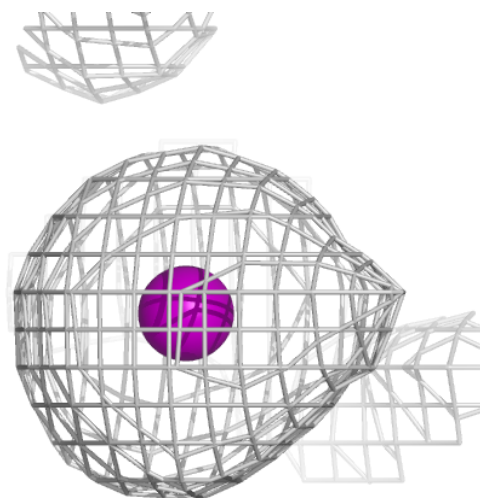

**Electron density around IOD A 626 (A):**

$2mF_o-DF_c$  (at 0.7 rmsd) in gray  
 $mF_o-DF_c$  (at 3 rmsd) in purple (negative)  
and green (positive)

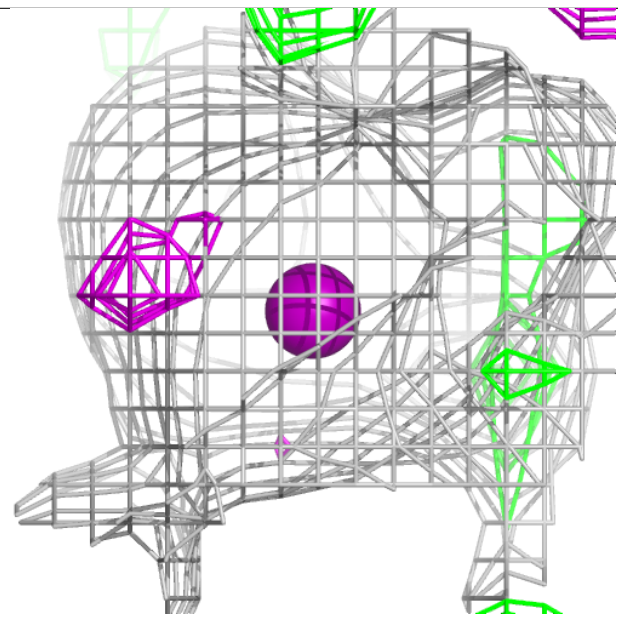
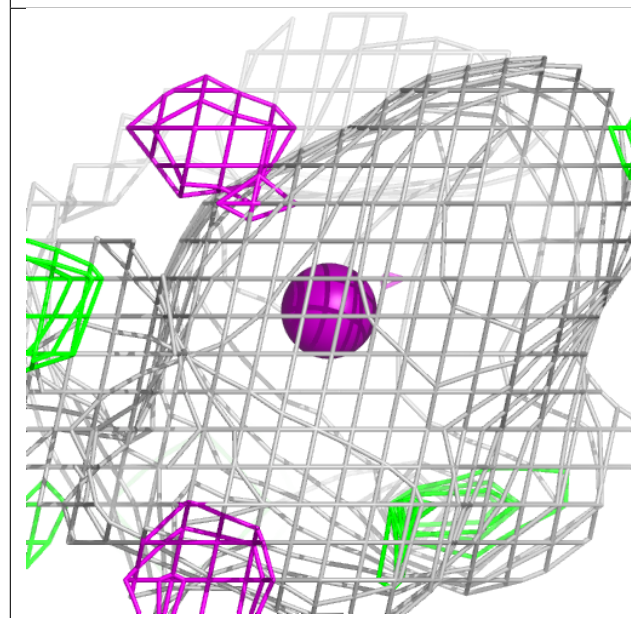
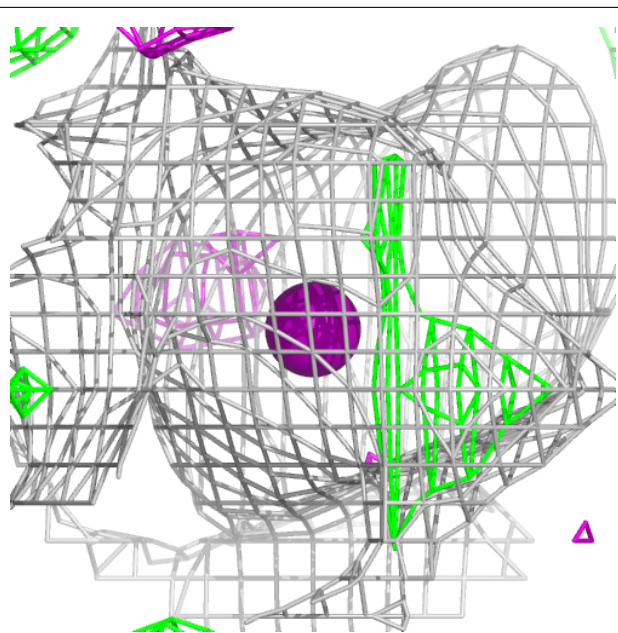

**Electron density around IOD A 626 (B):**

$2mF_o-DF_c$  (at 0.7 rmsd) in gray  
 $mF_o-DF_c$  (at 3 rmsd) in purple (negative)  
and green (positive)

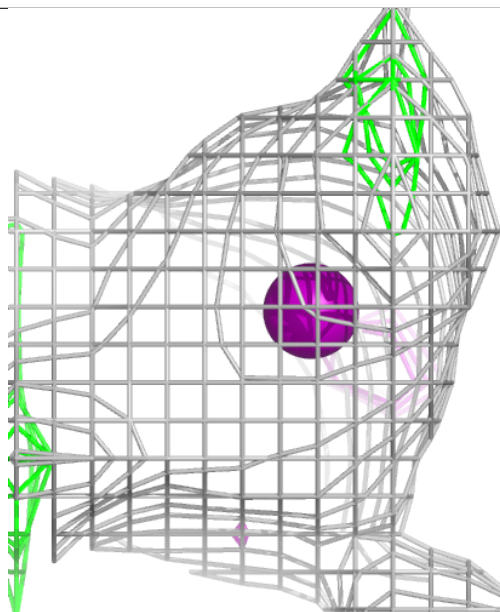
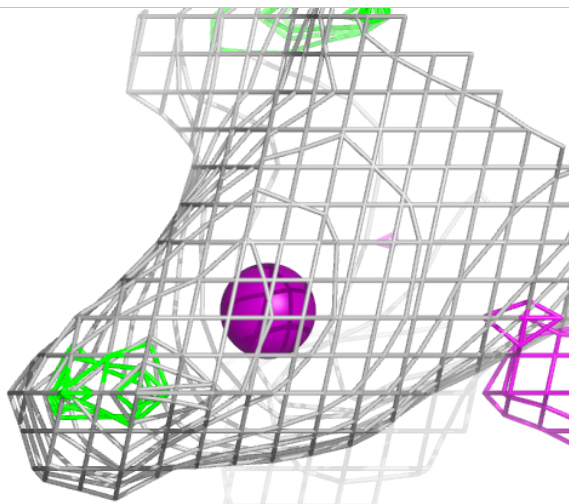
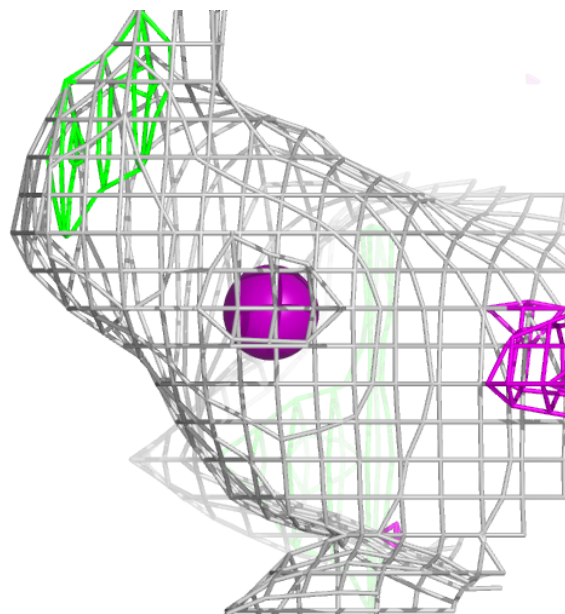

**Electron density around IOD A 608 (B):**

$2mF_o-DF_c$  (at 0.7 rmsd) in gray  
 $mF_o-DF_c$  (at 3 rmsd) in purple (negative)  
and green (positive)

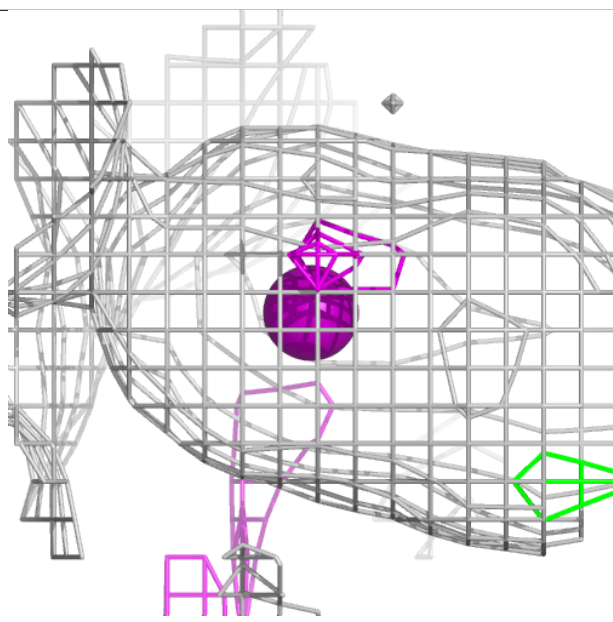
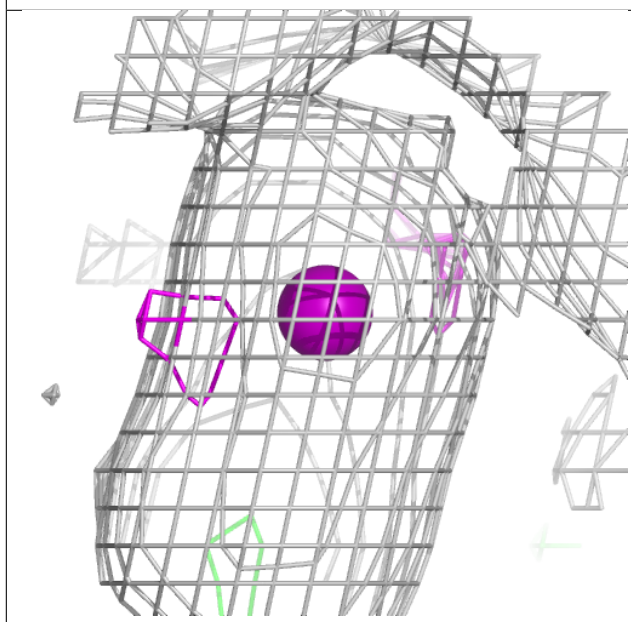
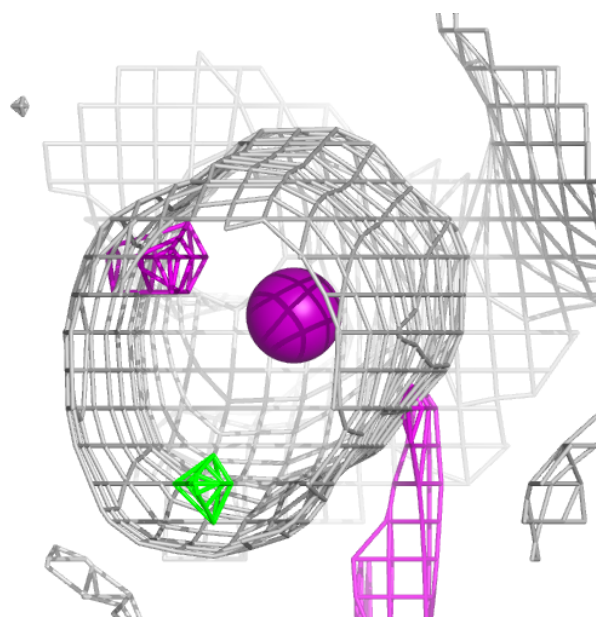

**Electron density around HEM A 616 (A):**

$2mF_o-DF_c$  (at 0.7 rmsd) in gray  
 $mF_o-DF_c$  (at 3 rmsd) in purple (negative)  
and green (positive)

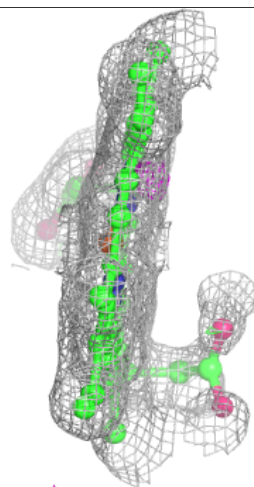
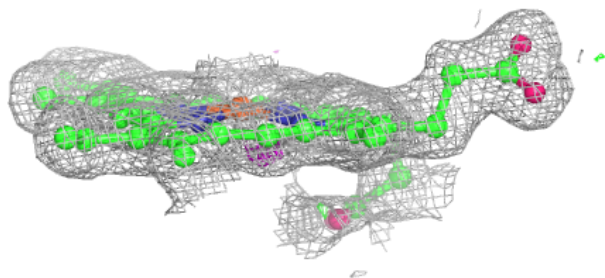
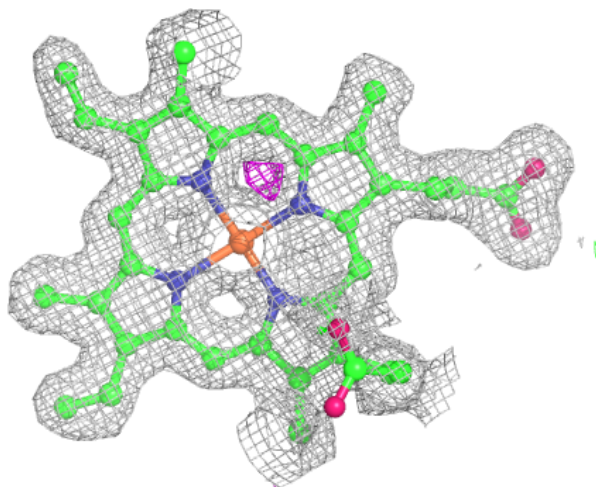



**Electron density around HEM A 616 (B):**

$2mF_o-DF_c$  (at 0.7 rmsd) in gray  
 $mF_o-DF_c$  (at 3 rmsd) in purple (negative)  
and green (positive)

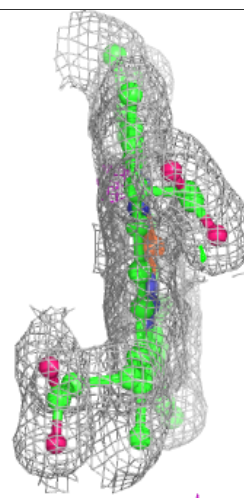
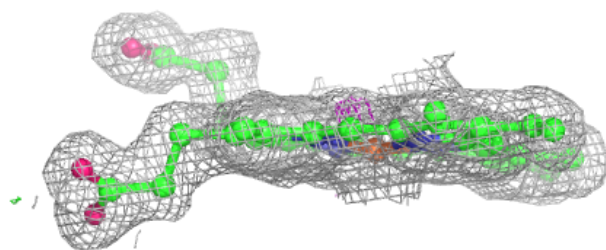
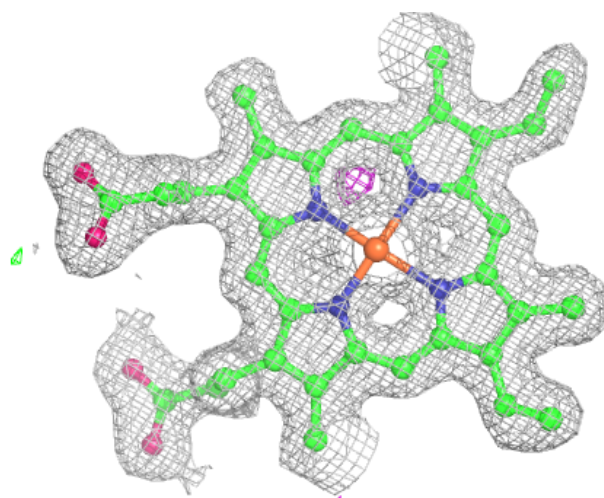

**Electron density around IOD A 608 (A):**

$2mF_o-DF_c$  (at 0.7 rmsd) in gray  
 $mF_o-DF_c$  (at 3 rmsd) in purple (negative)  
and green (positive)

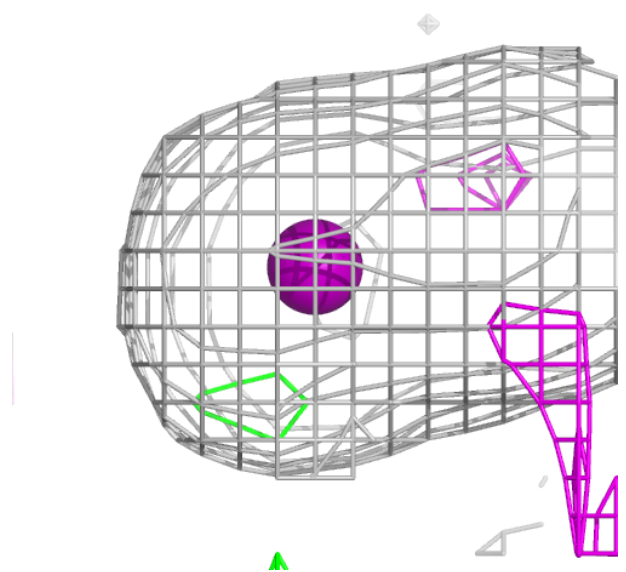
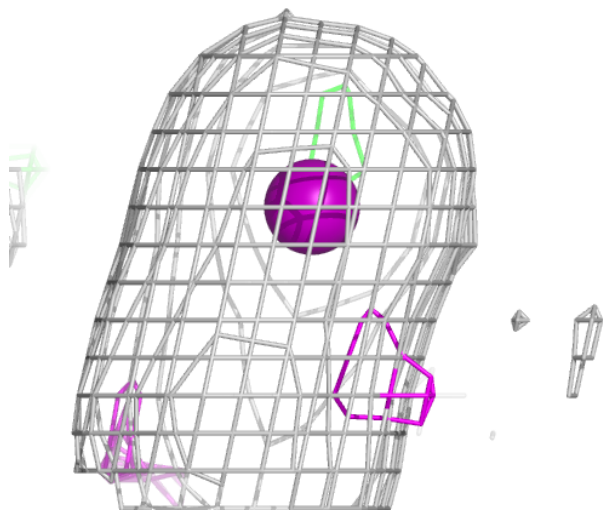
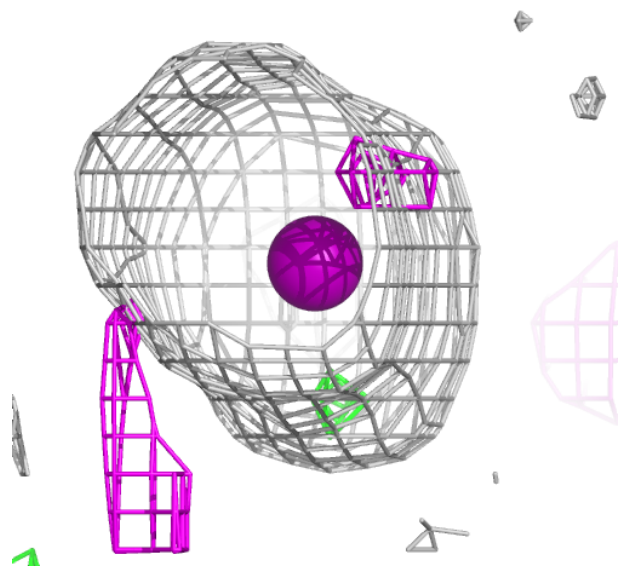

**Electron density around IOD A 610:**

$2mF_o-DF_c$  (at 0.7 rmsd) in gray  
 $mF_o-DF_c$  (at 3 rmsd) in purple (negative)  
and green (positive)

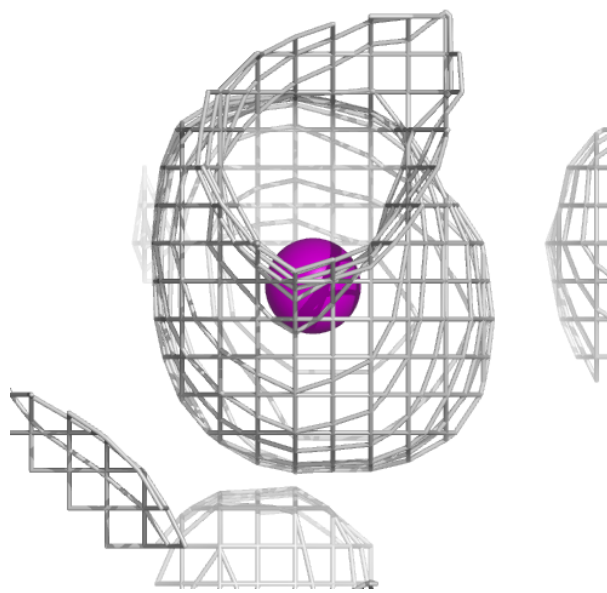
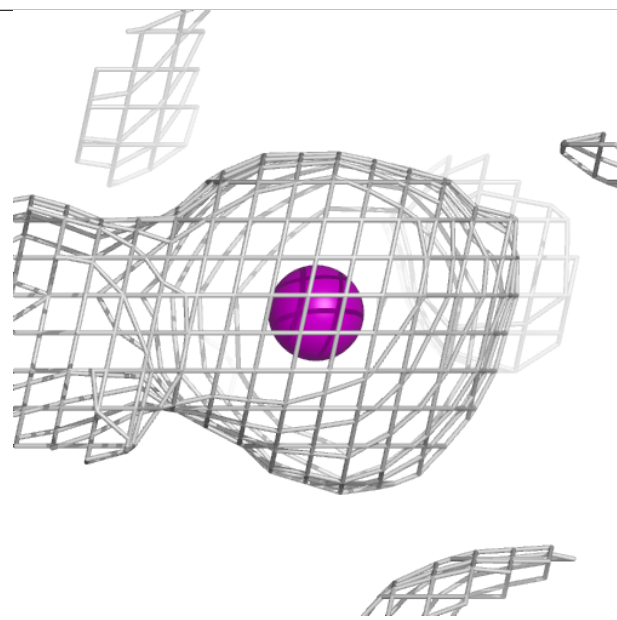
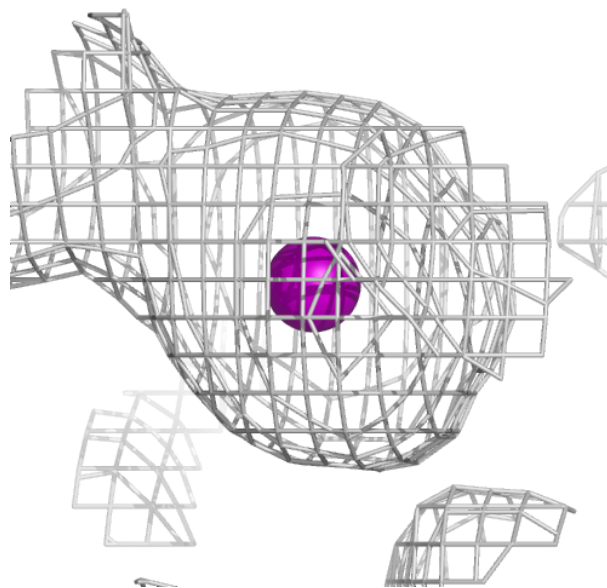

**Electron density around IOD A 620 (A):**

$2mF_o-DF_c$  (at 0.7 rmsd) in gray  
 $mF_o-DF_c$  (at 3 rmsd) in purple (negative)  
and green (positive)

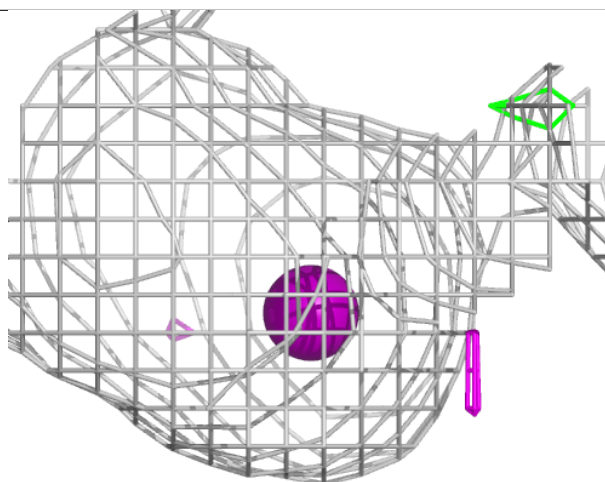
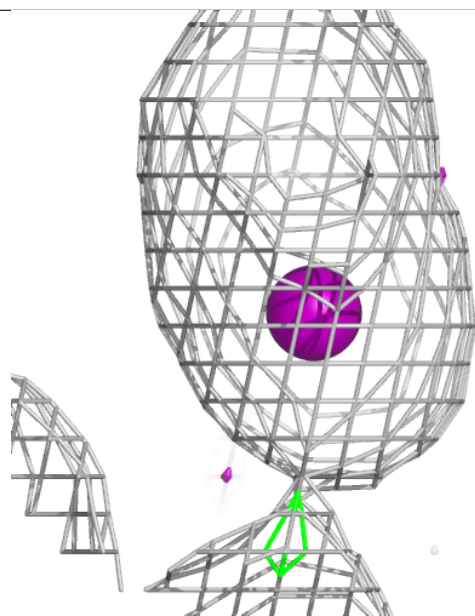
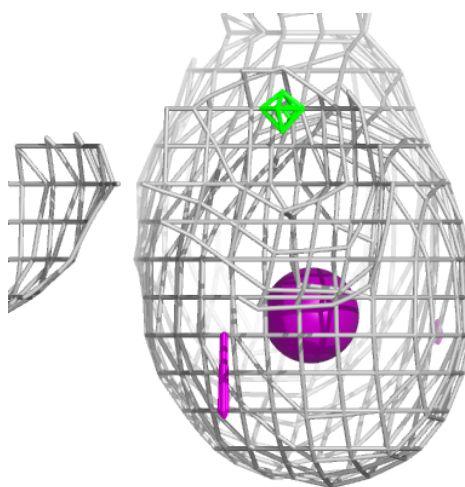

**Electron density around IOD A 620 (B):**

$2mF_o-DF_c$  (at 0.7 rmsd) in gray  
 $mF_o-DF_c$  (at 3 rmsd) in purple (negative)  
and green (positive)

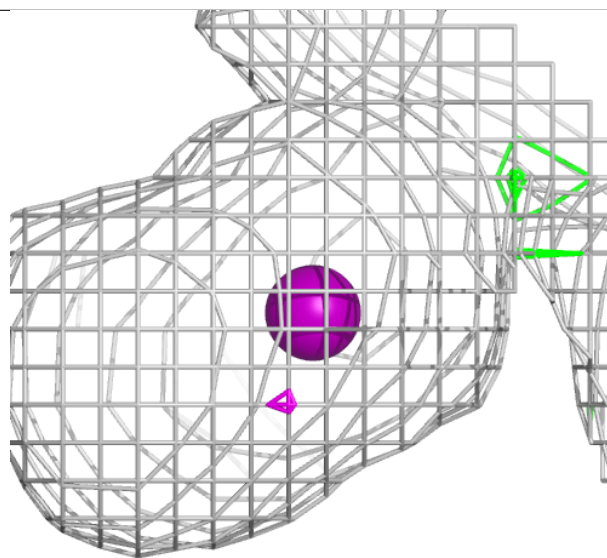
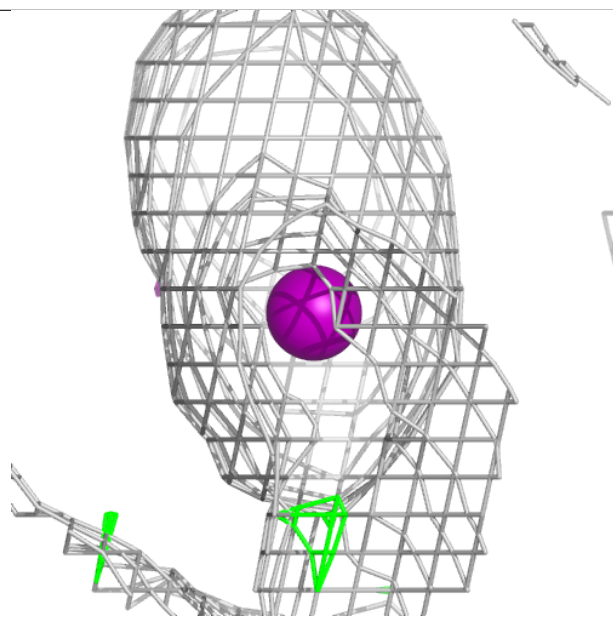
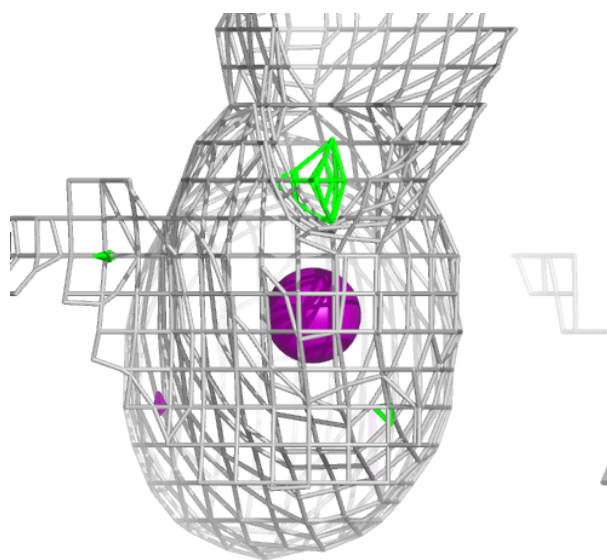

**Electron density around SCN A 618:**

$2mF_o-DF_c$  (at 0.7 rmsd) in gray  
 $mF_o-DF_c$  (at 3 rmsd) in purple (negative)  
and green (positive)

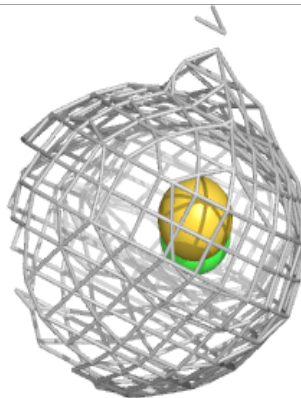
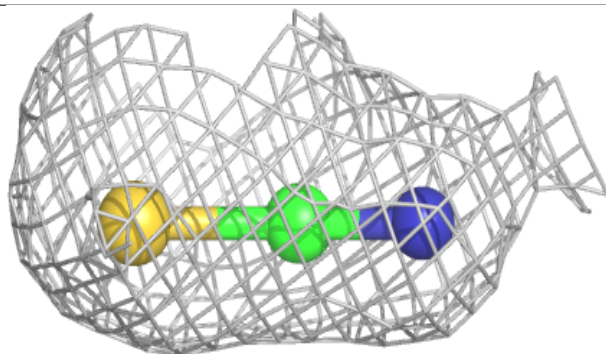
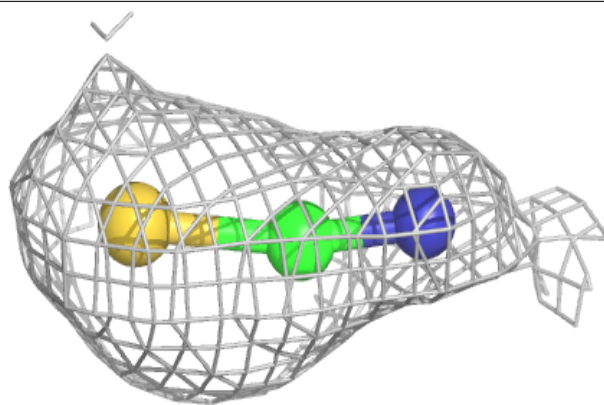

**Electron density around IOD A 630:**

$2mF_o-DF_c$  (at 0.7 rmsd) in gray  
 $mF_o-DF_c$  (at 3 rmsd) in purple (negative)  
and green (positive)

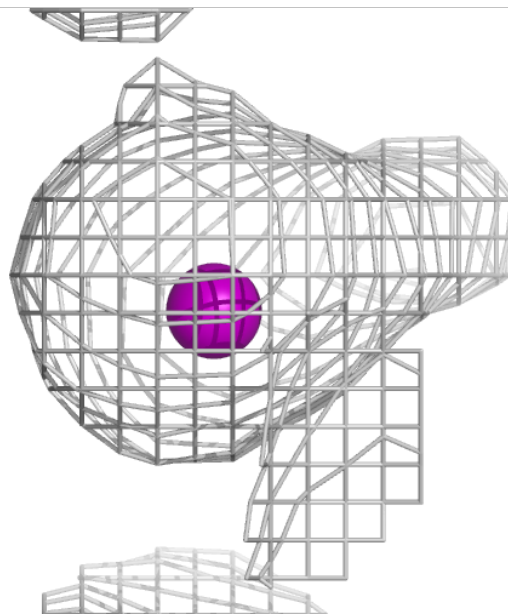
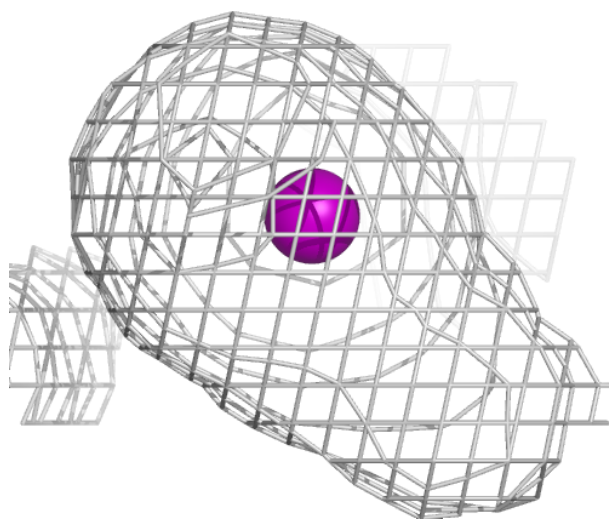
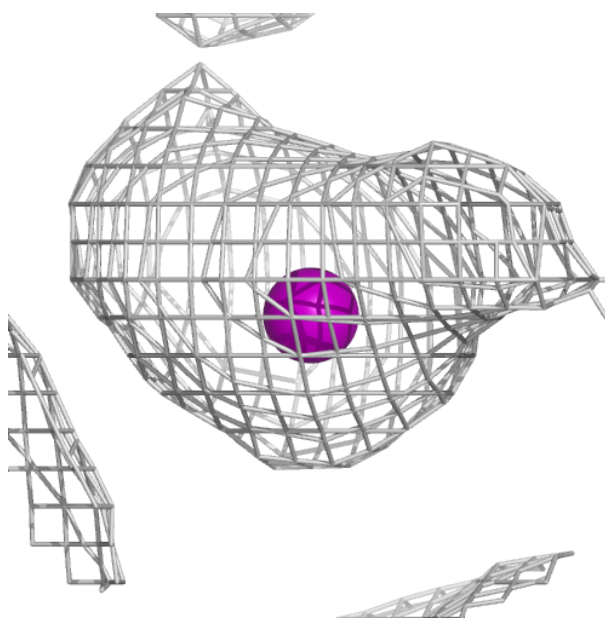

**Electron density around CA A 601:**

$2mF_o-DF_c$  (at 0.7 rmsd) in gray  
 $mF_o-DF_c$  (at 3 rmsd) in purple (negative)  
and green (positive)

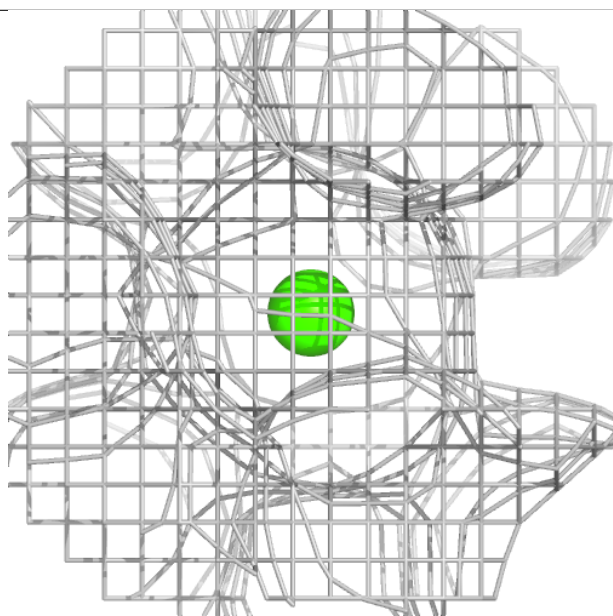
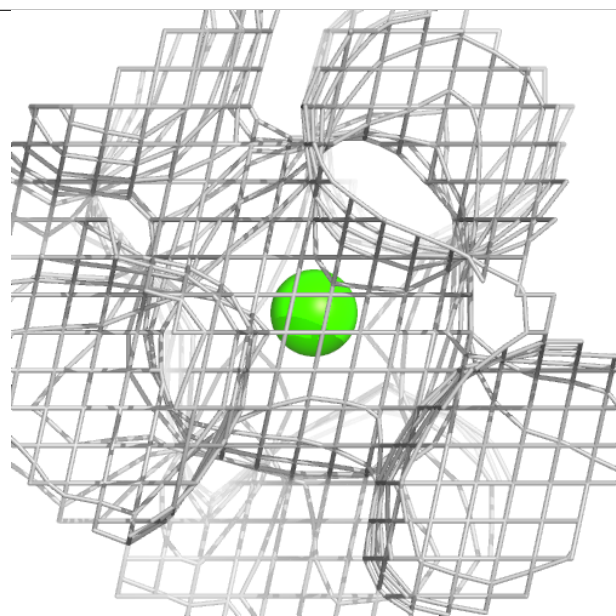
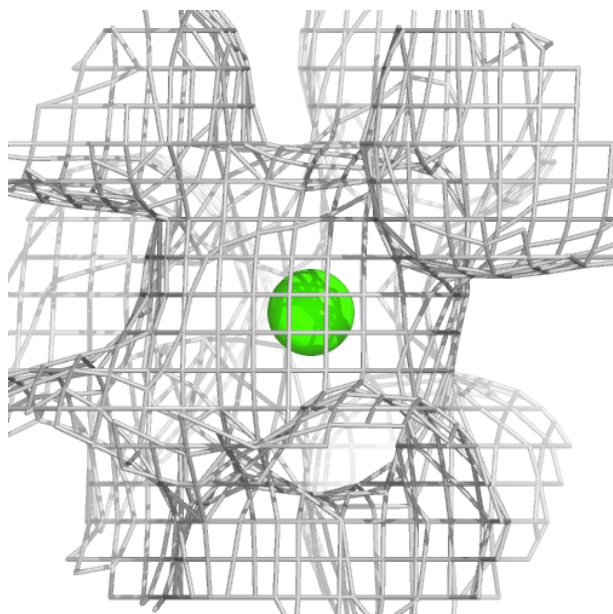



**Electron density around IOD A 622 (A):**

$2mF_o-DF_c$  (at 0.7 rmsd) in gray  
 $mF_o-DF_c$  (at 3 rmsd) in purple (negative)  
and green (positive)

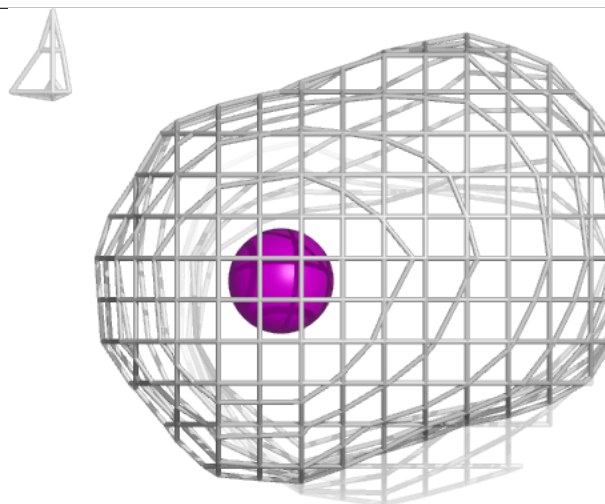
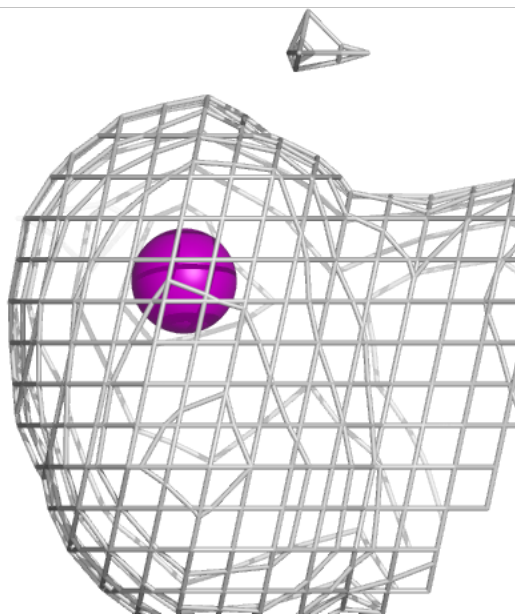
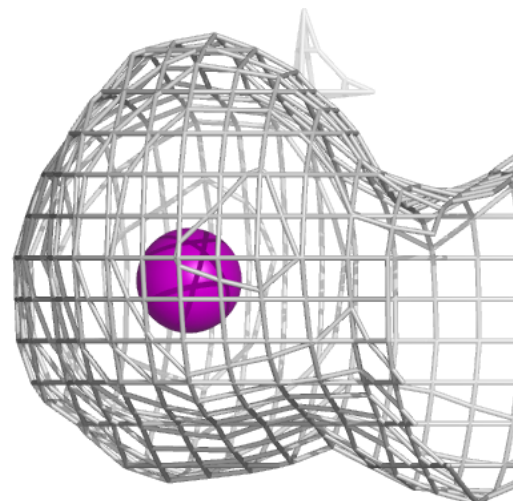

**Electron density around IOD A 622 (B):**

$2mF_o-DF_c$  (at 0.7 rmsd) in gray  
 $mF_o-DF_c$  (at 3 rmsd) in purple (negative)  
and green (positive)

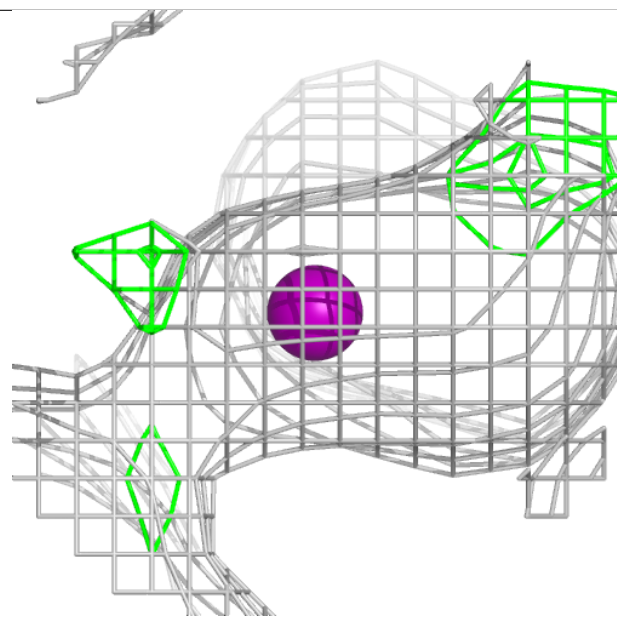
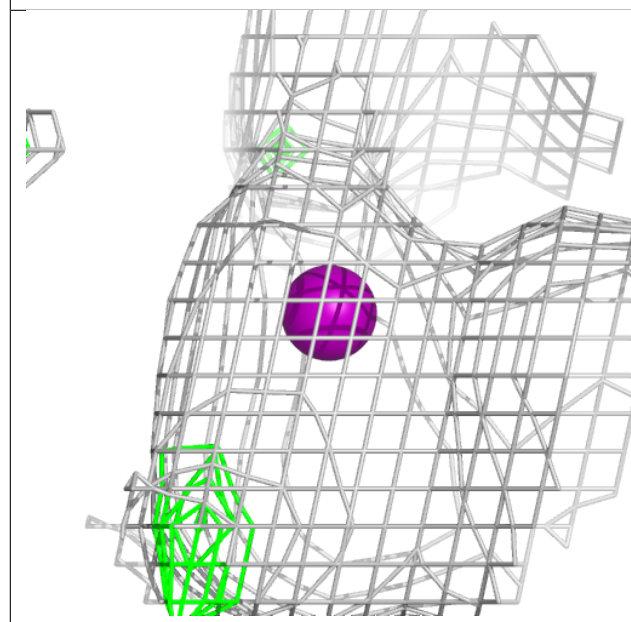
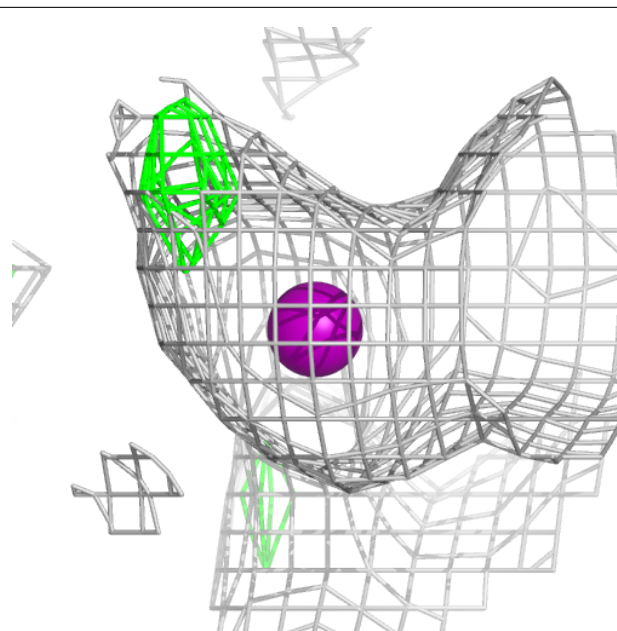

**Electron density around IOD A 622 (C):**

$2mF_o-DF_c$  (at 0.7 rmsd) in gray  
 $mF_o-DF_c$  (at 3 rmsd) in purple (negative)  
and green (positive)

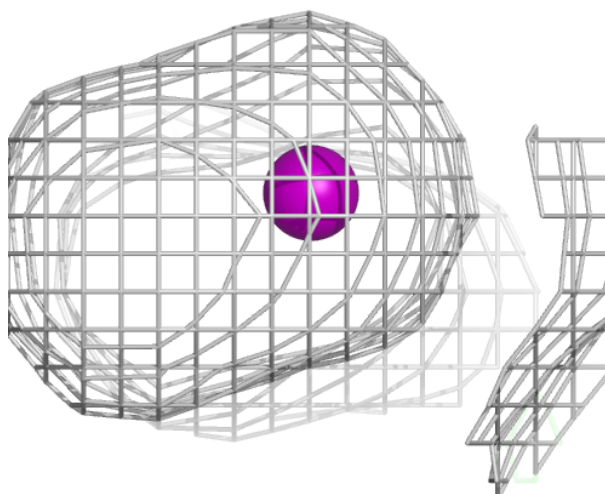
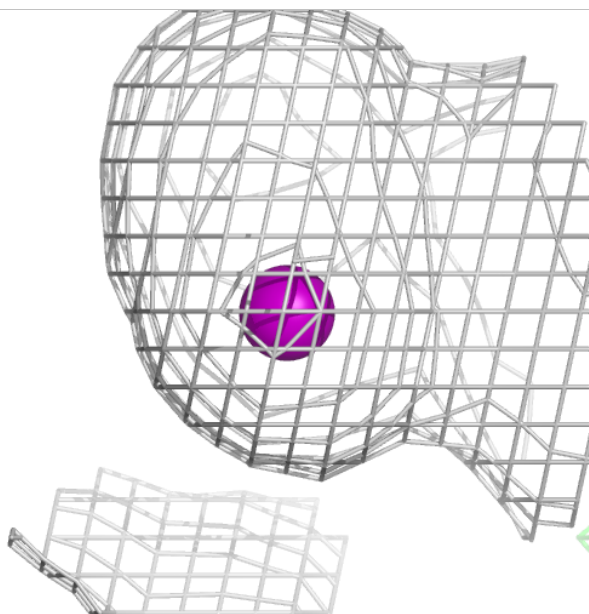
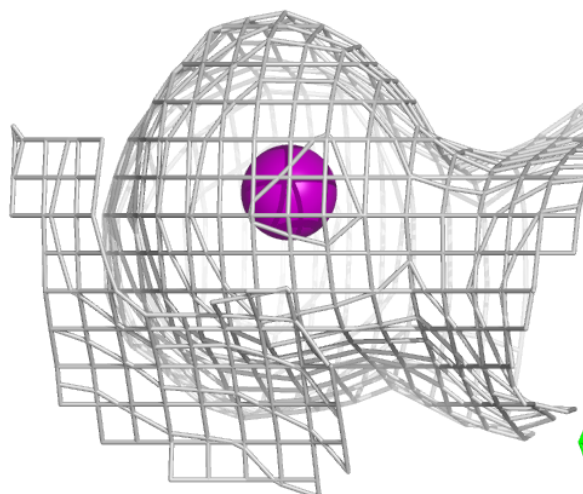

**Electron density around IOD A 622 (D):**

$2mF_o-DF_c$  (at 0.7 rmsd) in gray  
 $mF_o-DF_c$  (at 3 rmsd) in purple (negative)  
and green (positive)

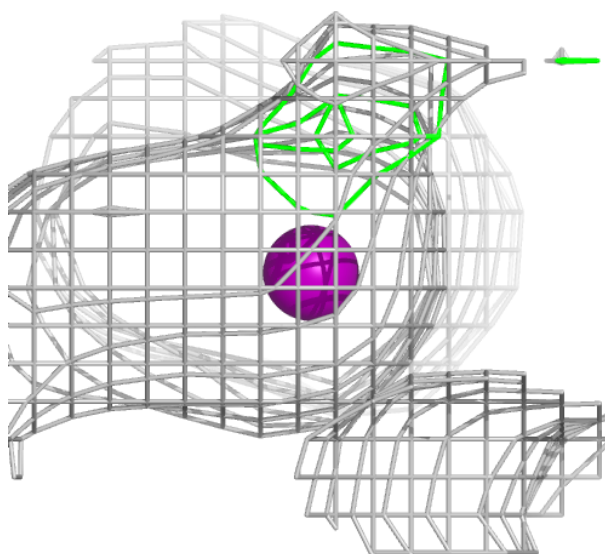
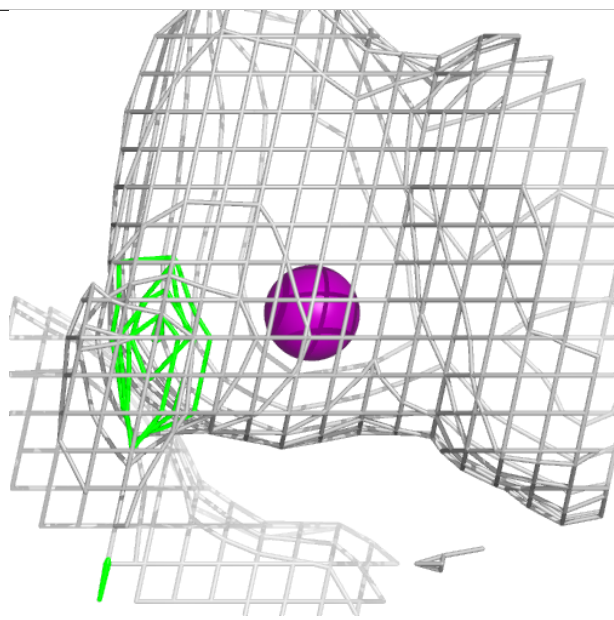
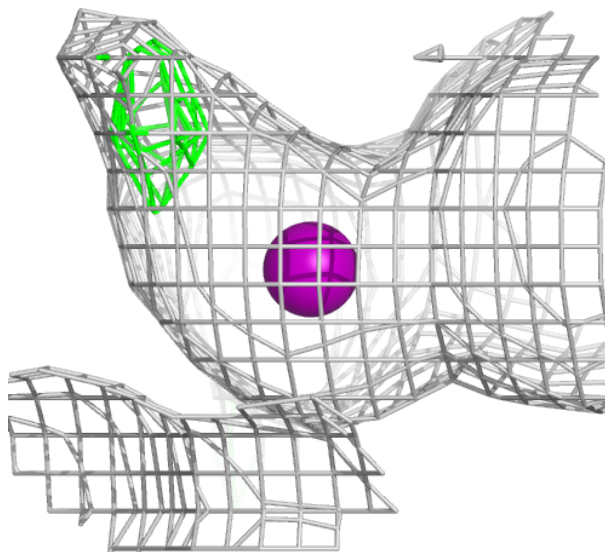

**Electron density around IOD A 603 (A):**

$2mF_o-DF_c$  (at 0.7 rmsd) in gray  
 $mF_o-DF_c$  (at 3 rmsd) in purple (negative)  
and green (positive)

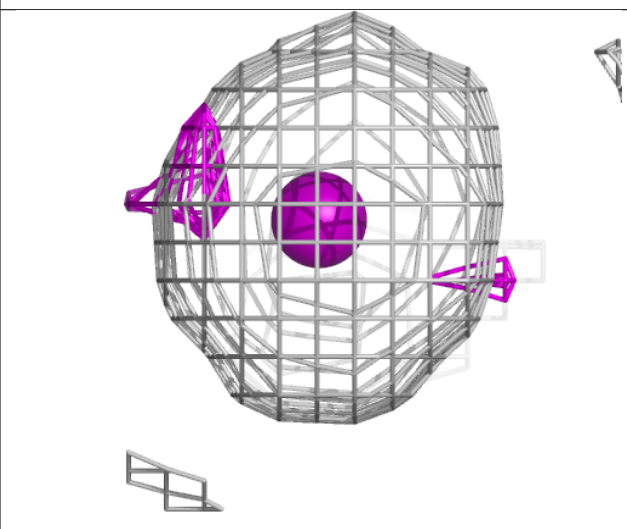
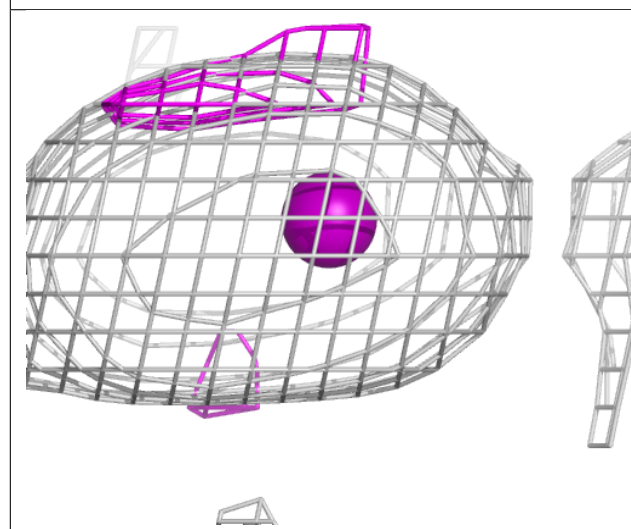
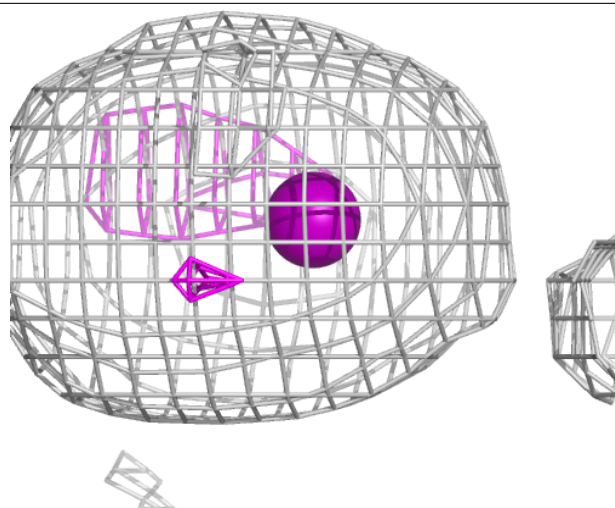

**Electron density around IOD A 625:**

$2mF_o-DF_c$  (at 0.7 rmsd) in gray  
 $mF_o-DF_c$  (at 3 rmsd) in purple (negative)  
and green (positive)

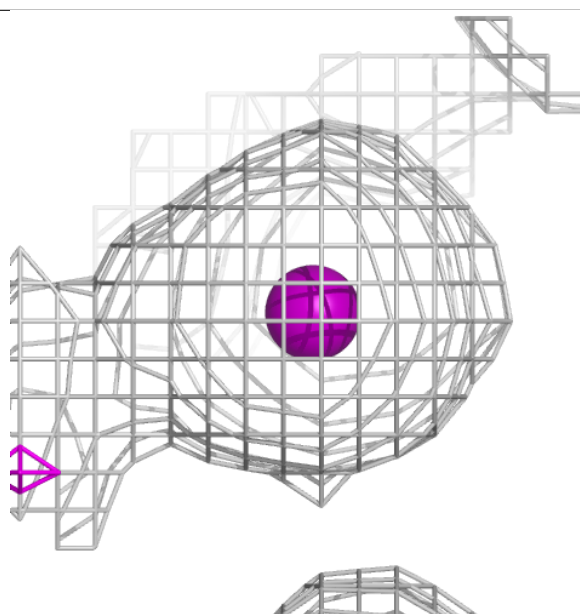
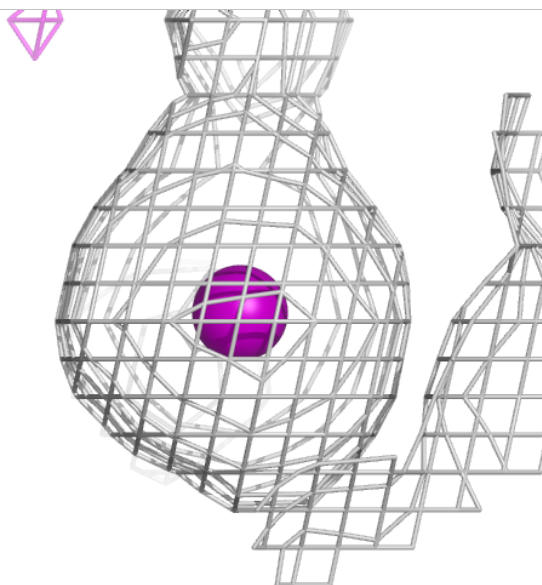
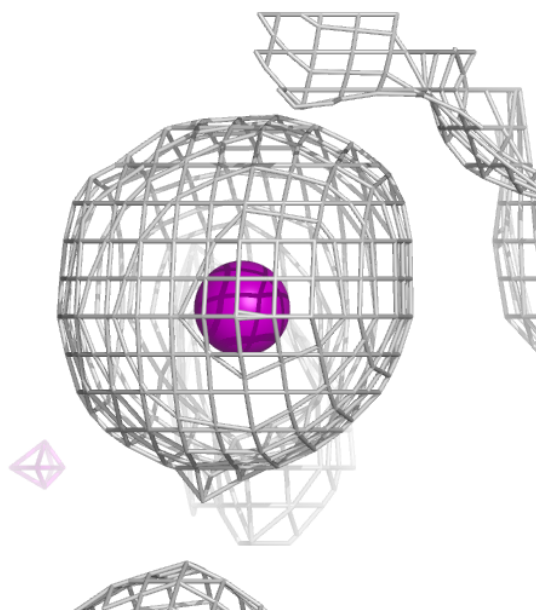

**Electron density around IOD A 603 (B):**

$2mF_o-DF_c$  (at 0.7 rmsd) in gray  
 $mF_o-DF_c$  (at 3 rmsd) in purple (negative)  
and green (positive)

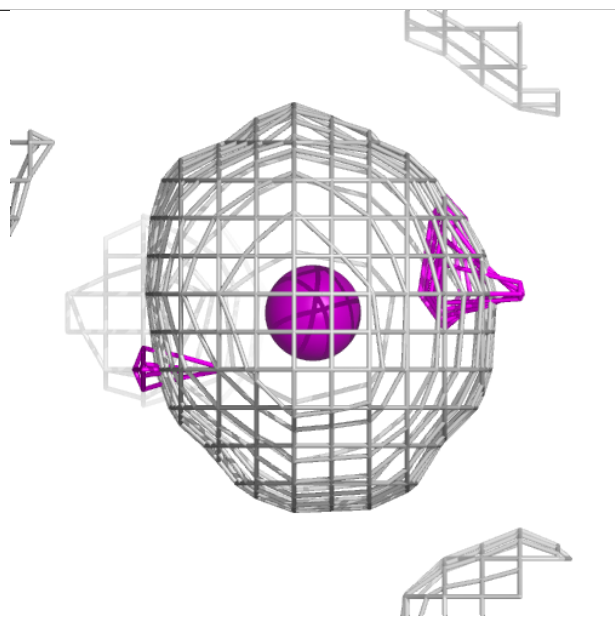
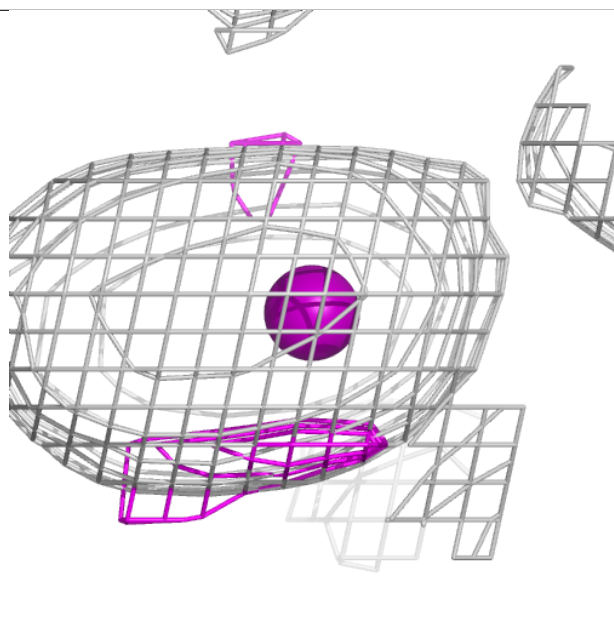
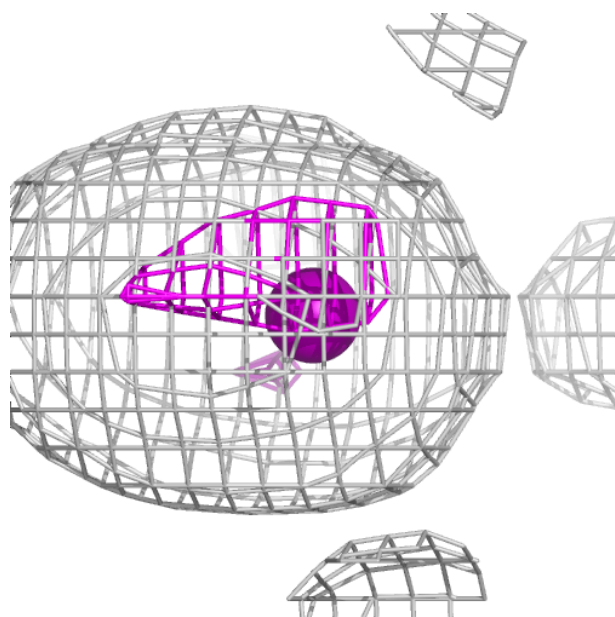

**Electron density around IOD A 606 (A):**

$2mF_o-DF_c$  (at 0.7 rmsd) in gray  
 $mF_o-DF_c$  (at 3 rmsd) in purple (negative)  
and green (positive)

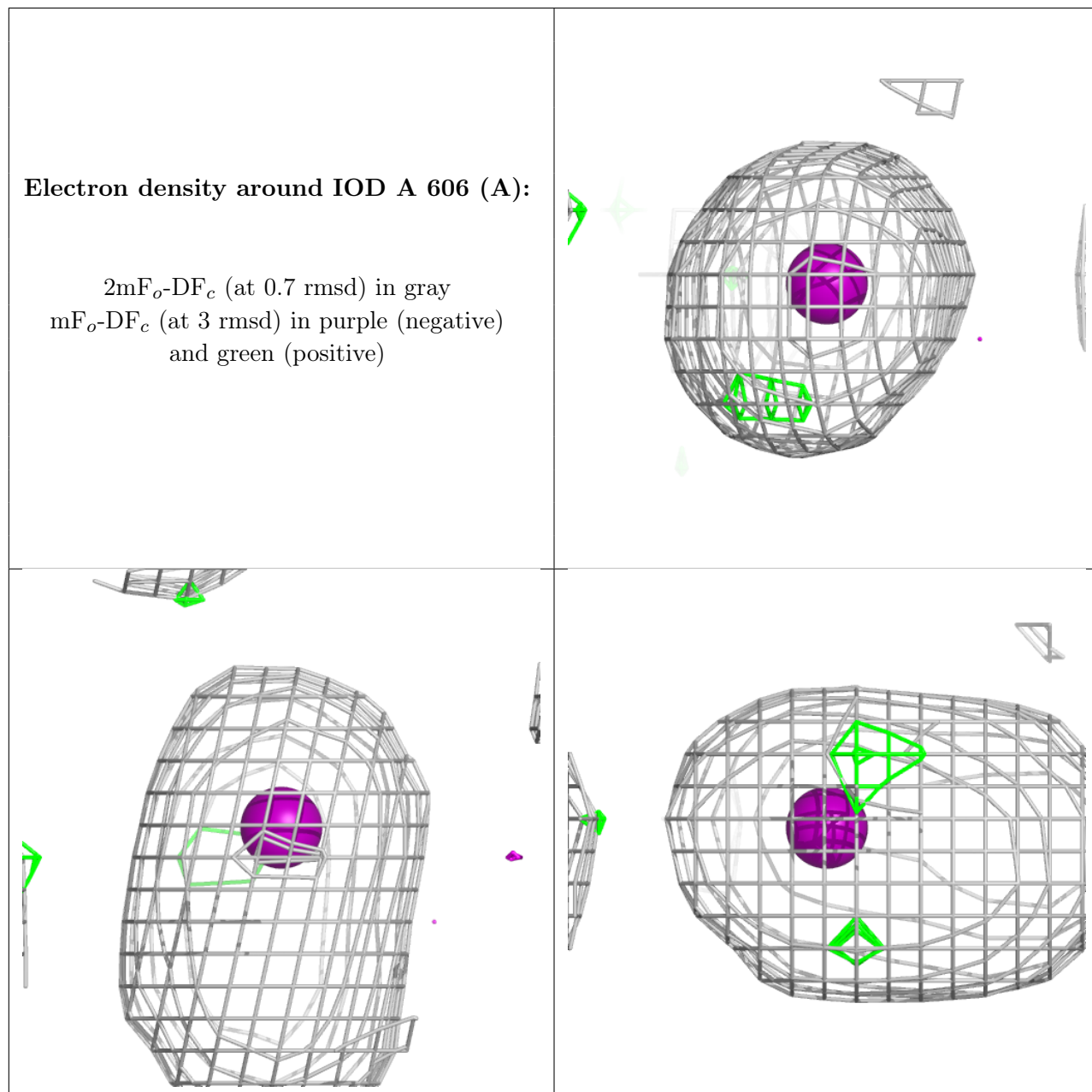



**Electron density around IOD A 627 (A):**

$2mF_o-DF_c$  (at 0.7 rmsd) in gray  
 $mF_o-DF_c$  (at 3 rmsd) in purple (negative)  
and green (positive)

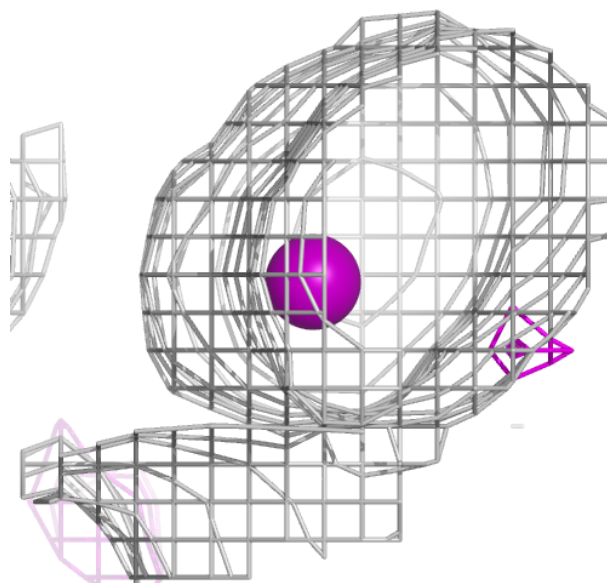
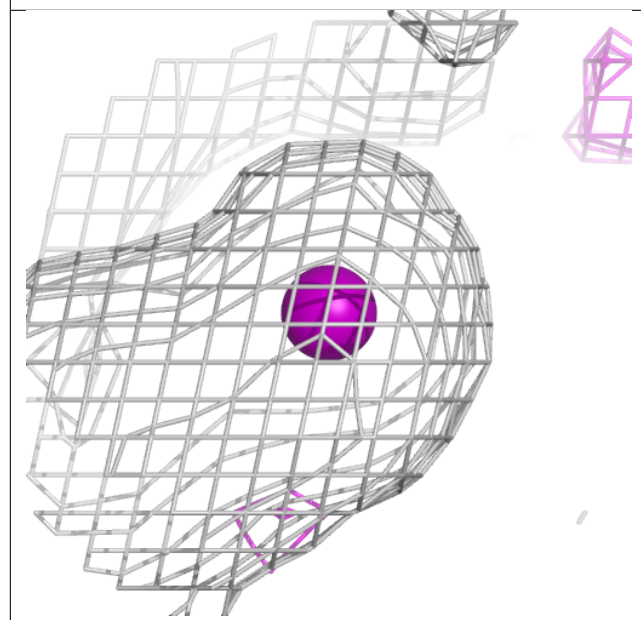
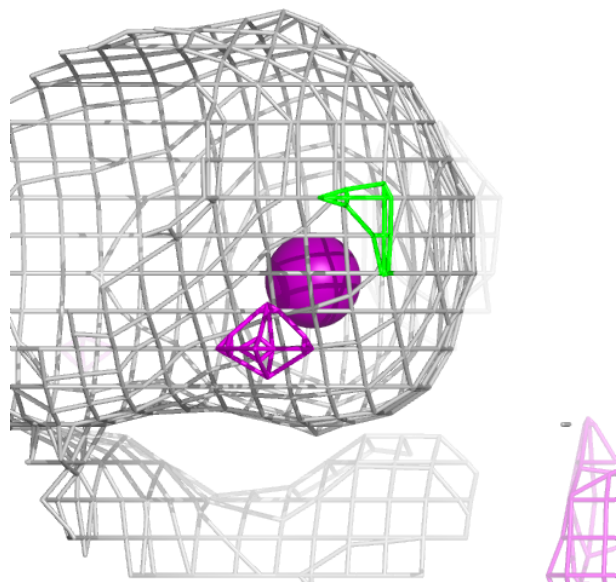

**Electron density around IOD A 627 (B):**

$2mF_o-DF_c$  (at 0.7 rmsd) in gray  
 $mF_o-DF_c$  (at 3 rmsd) in purple (negative)  
and green (positive)

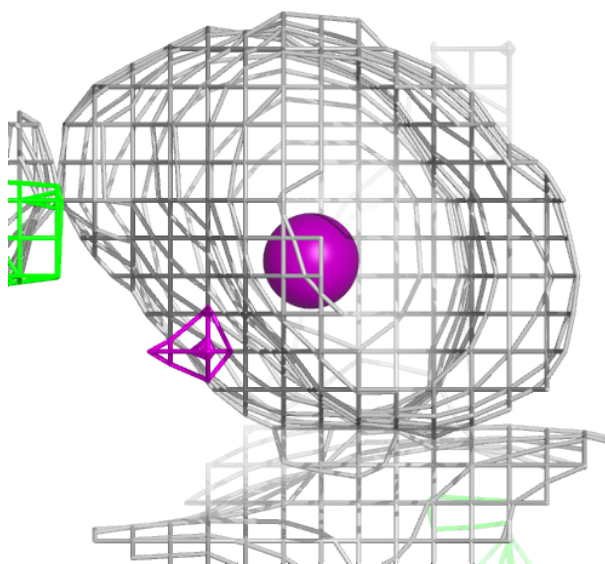
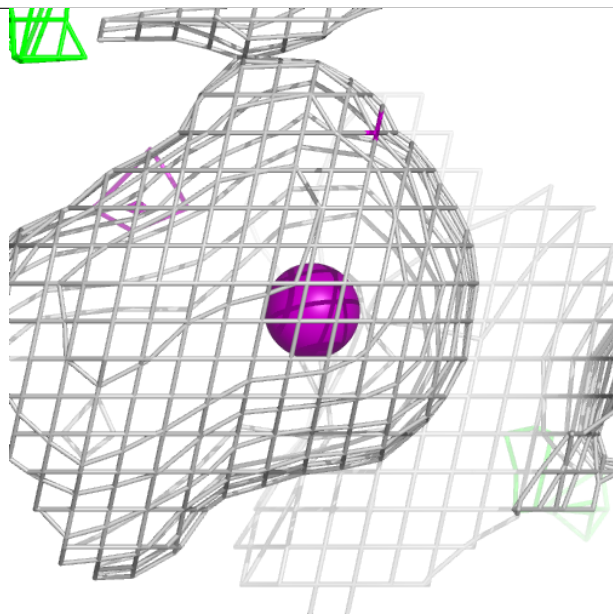
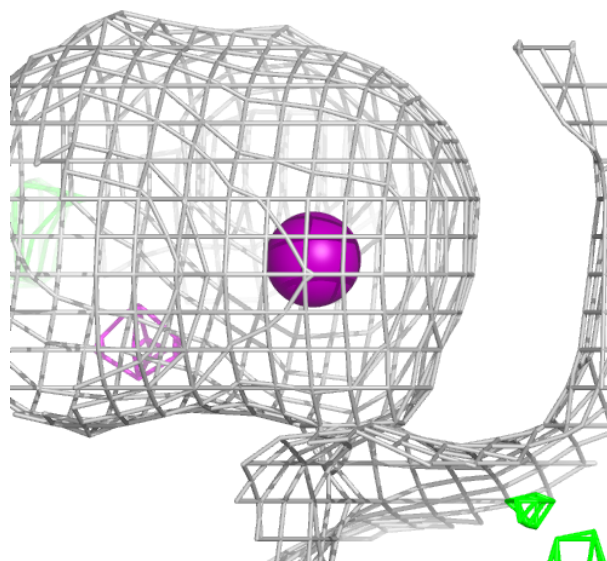

**Electron density around IOD A 627 (C):**

$2mF_o-DF_c$  (at 0.7 rmsd) in gray  
 $mF_o-DF_c$  (at 3 rmsd) in purple (negative)  
and green (positive)

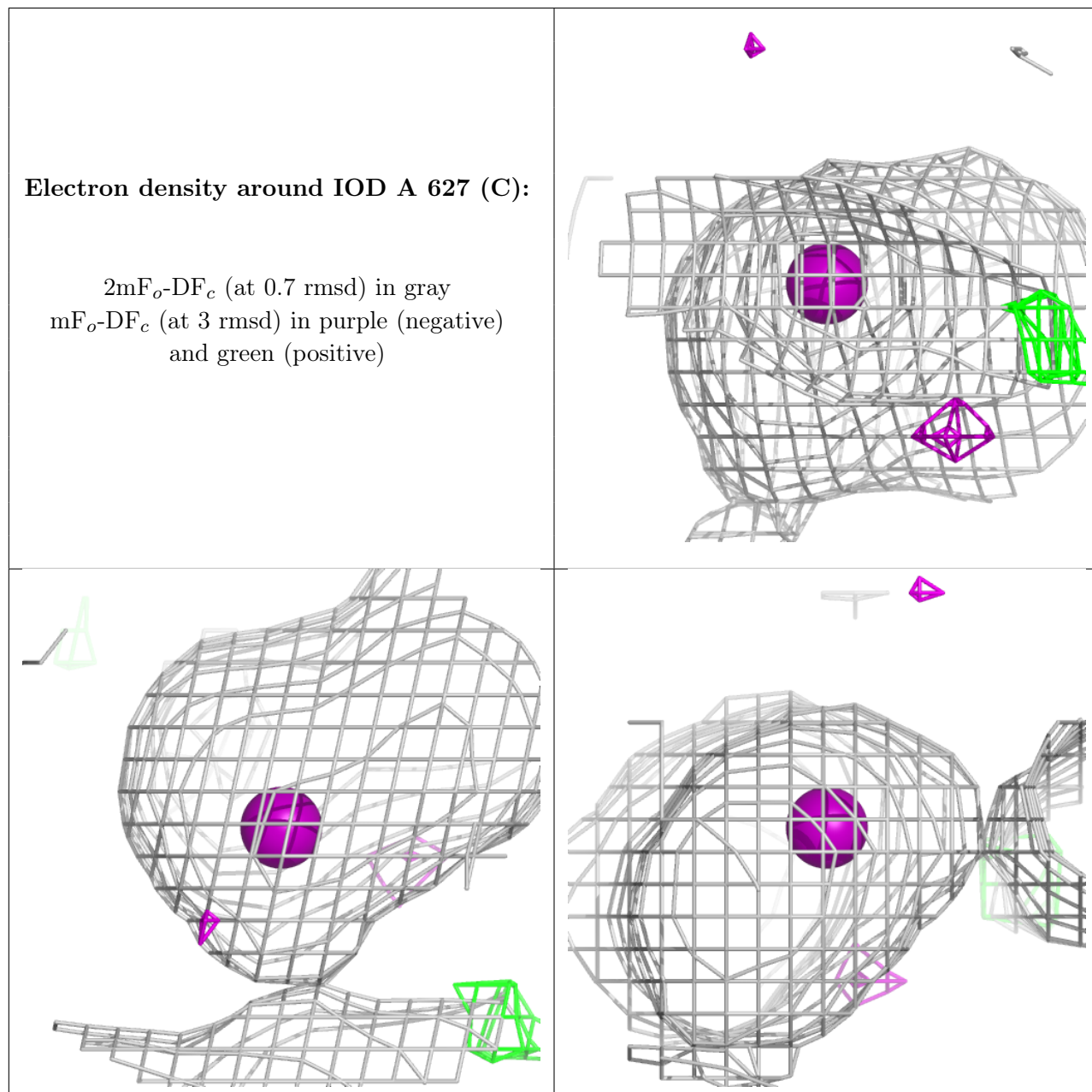

**Electron density around IOD A 627 (D):**

$2mF_o-DF_c$  (at 0.7 rmsd) in gray  
 $mF_o-DF_c$  (at 3 rmsd) in purple (negative)  
and green (positive)

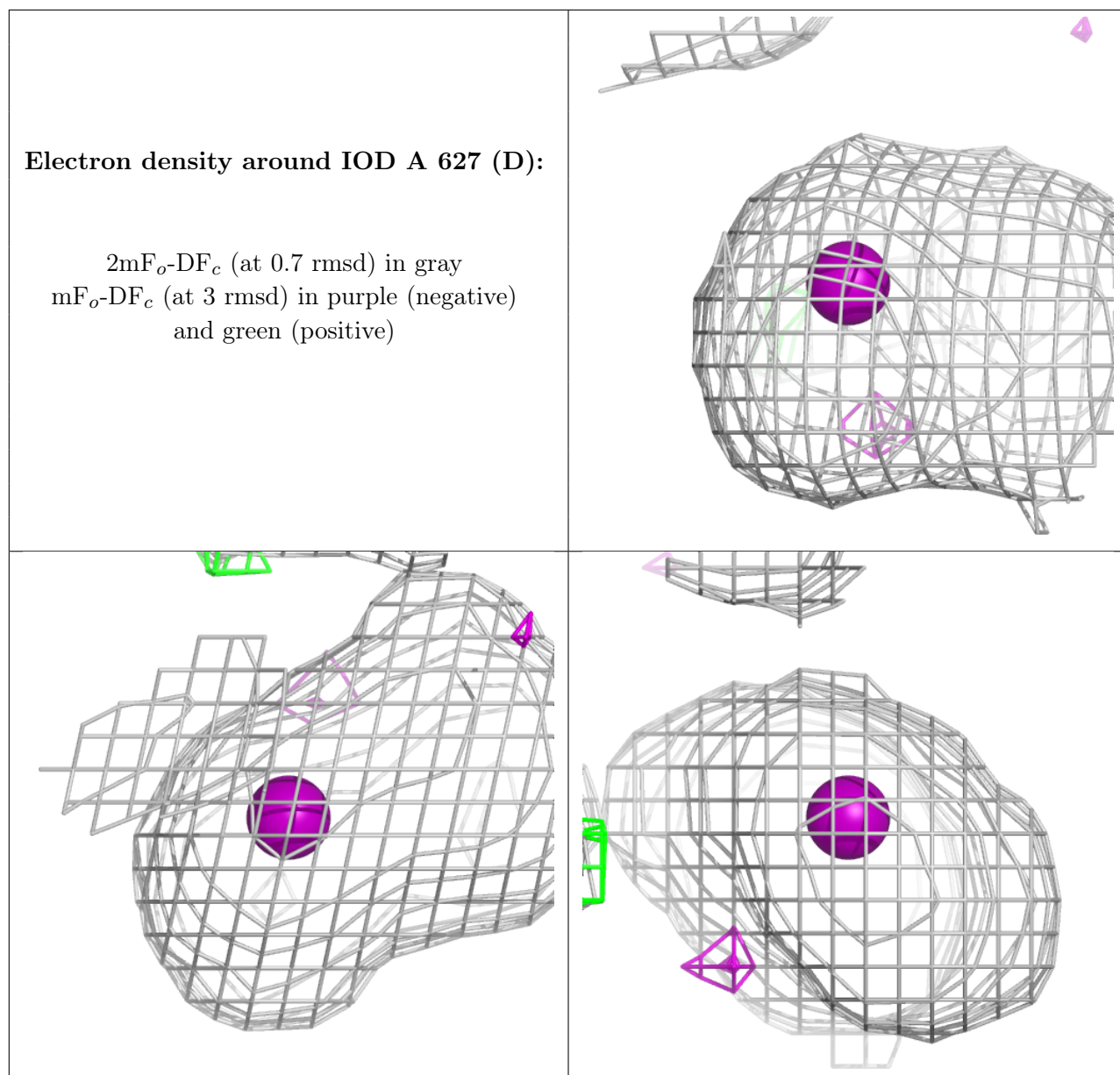

**Electron density around IOD A 628 (A):**

$2mF_o-DF_c$  (at 0.7 rmsd) in gray  
 $mF_o-DF_c$  (at 3 rmsd) in purple (negative)  
and green (positive)

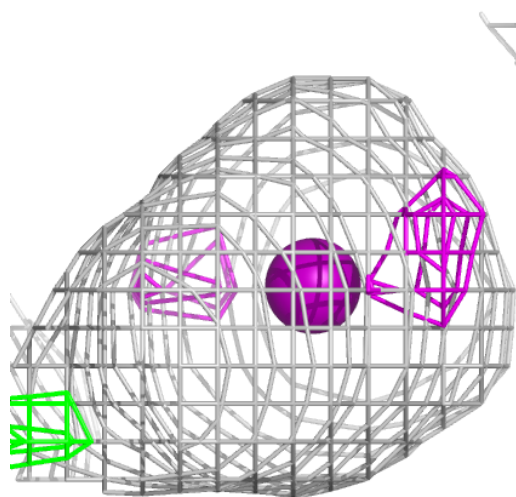
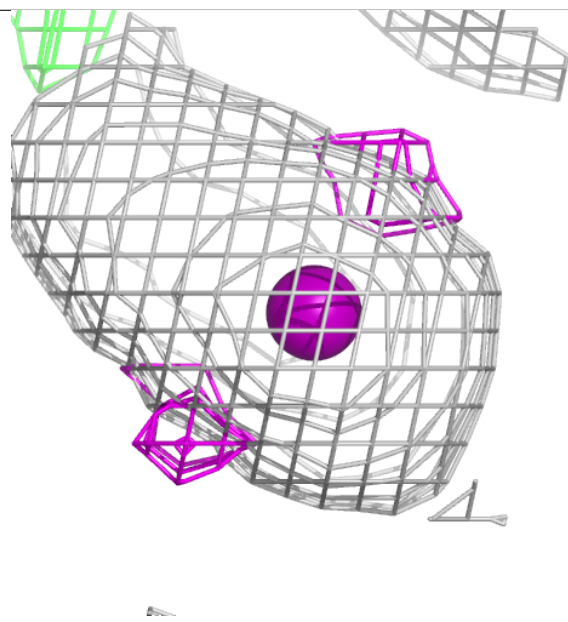
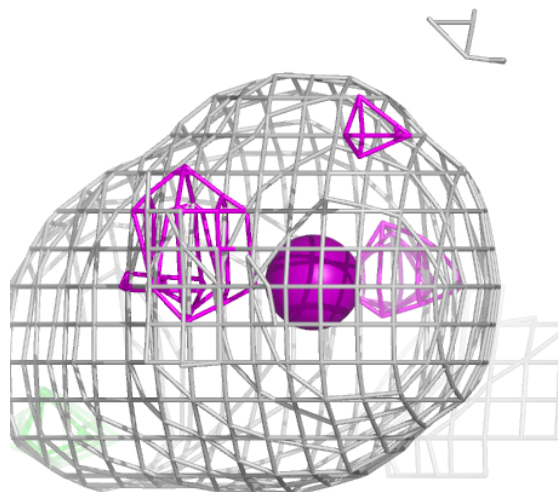

**Electron density around IOD A 628 (B):**

$2mF_o-DF_c$  (at 0.7 rmsd) in gray  
 $mF_o-DF_c$  (at 3 rmsd) in purple (negative)  
and green (positive)

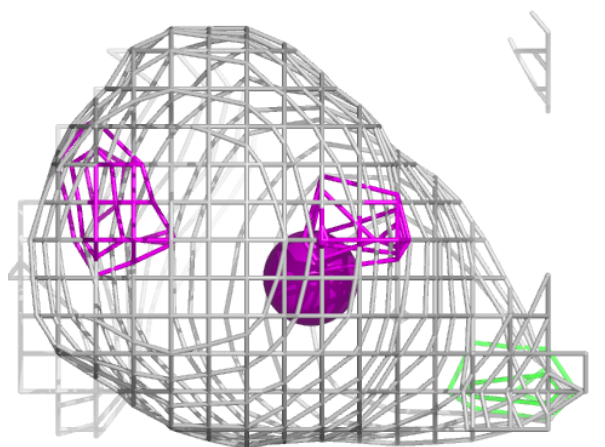
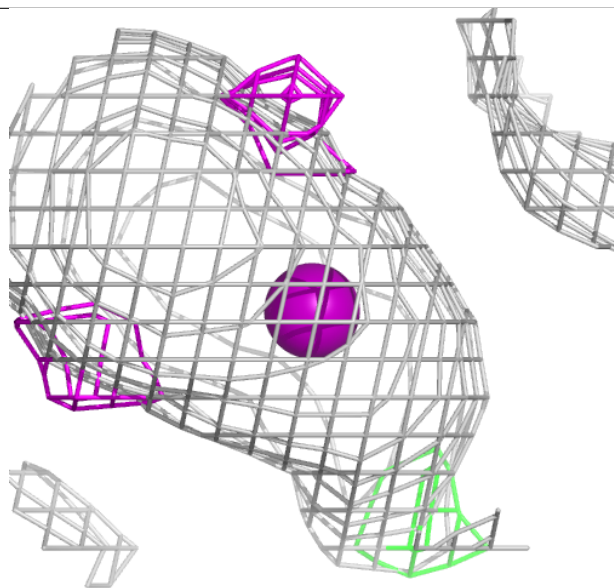
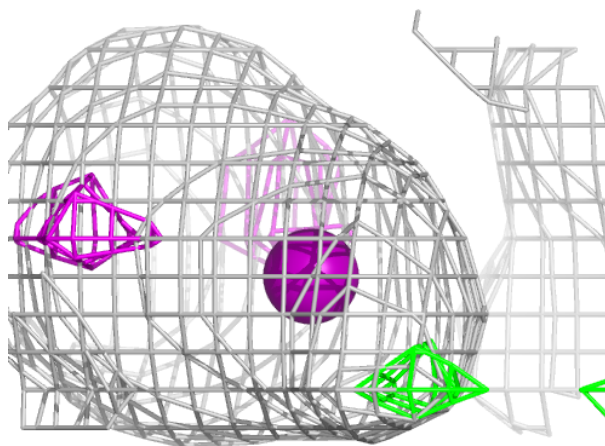

**Electron density around IOD A 606 (B):**

$2mF_o-DF_c$  (at 0.7 rmsd) in gray  
 $mF_o-DF_c$  (at 3 rmsd) in purple (negative)  
and green (positive)

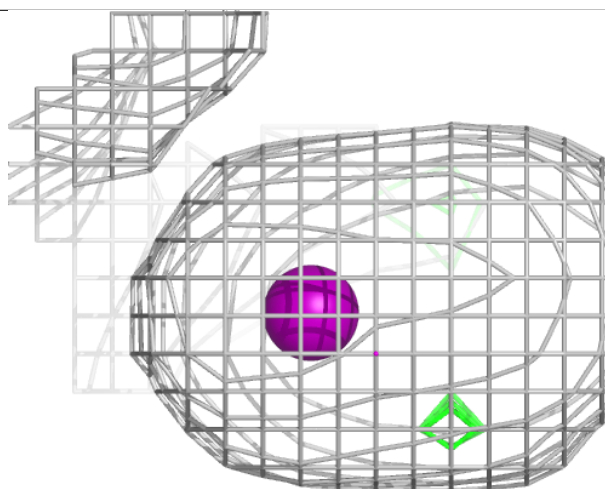
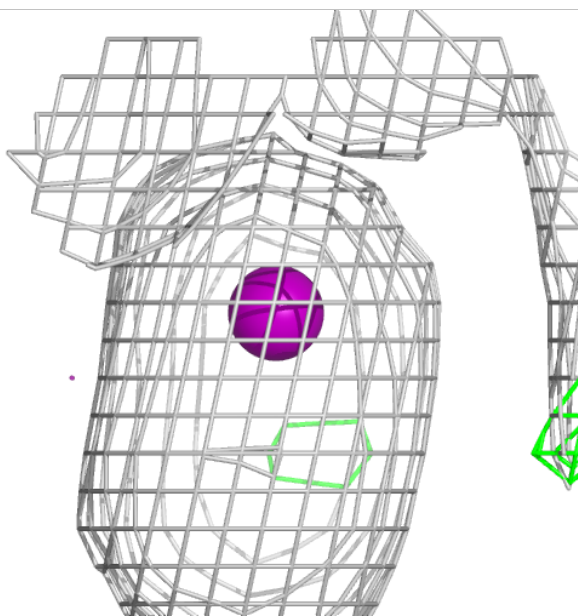
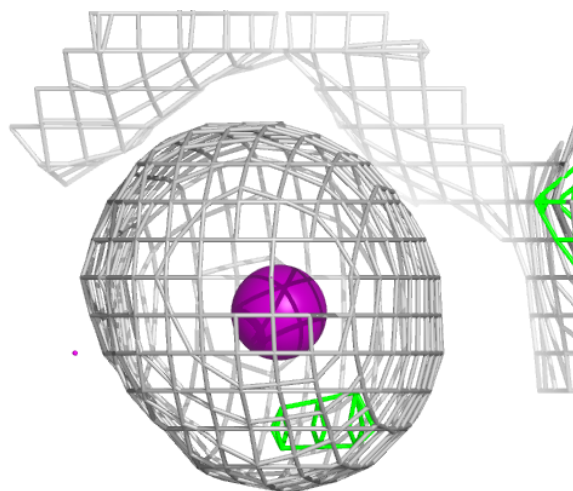

**Electron density around IOD A 607:**

$2mF_o-DF_c$  (at 0.7 rmsd) in gray  
 $mF_o-DF_c$  (at 3 rmsd) in purple (negative)  
and green (positive)

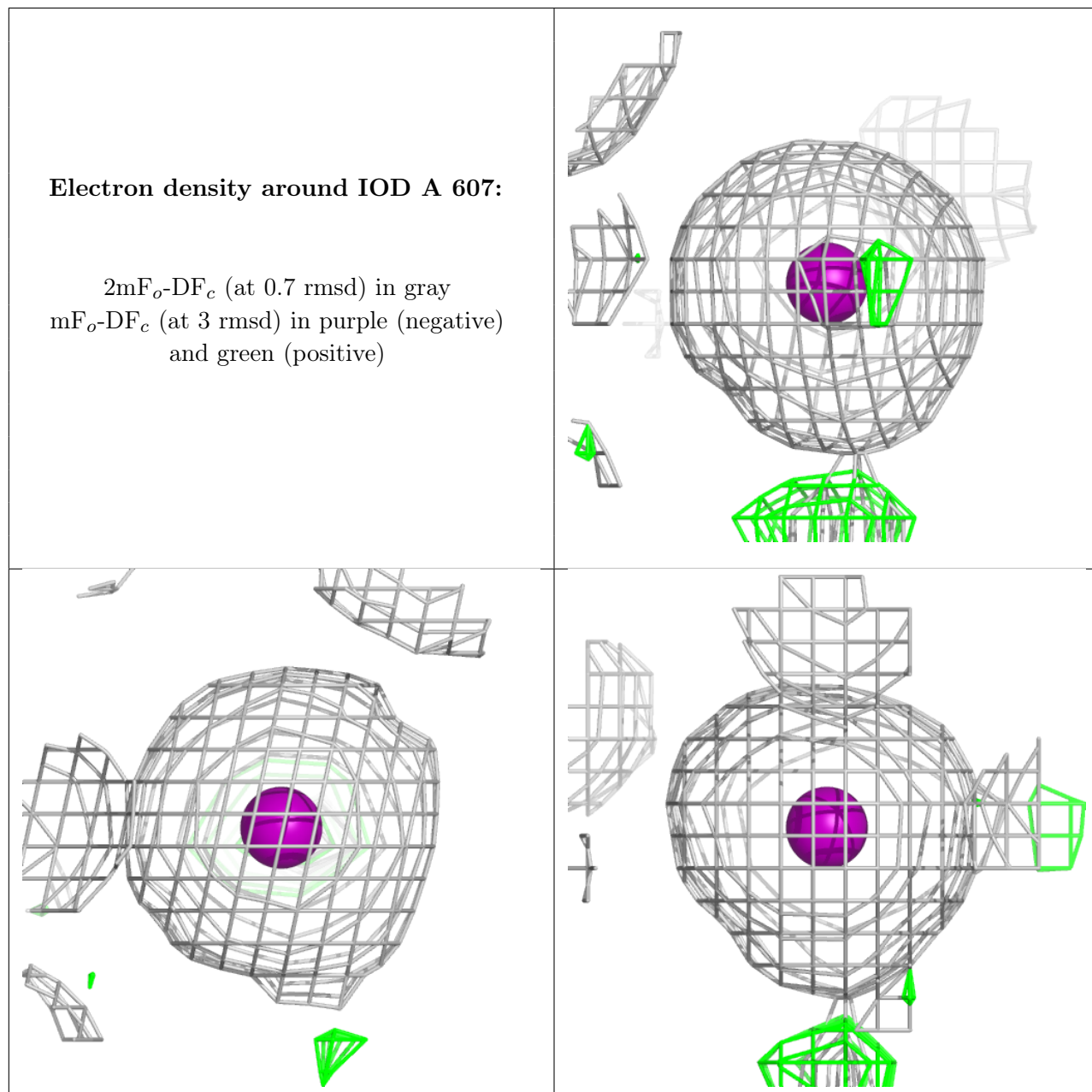



**Electron density around IOD A 621:**

$2mF_o-DF_c$  (at 0.7 rmsd) in gray  
 $mF_o-DF_c$  (at 3 rmsd) in purple (negative)  
and green (positive)

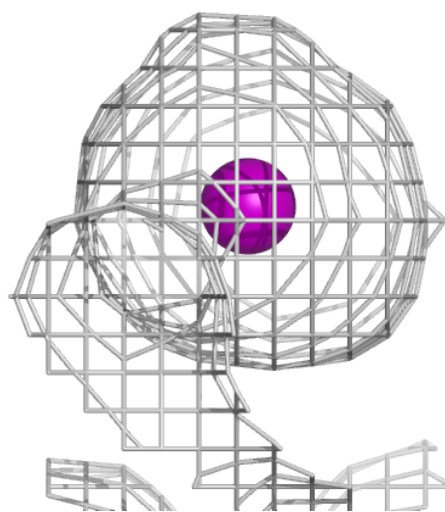
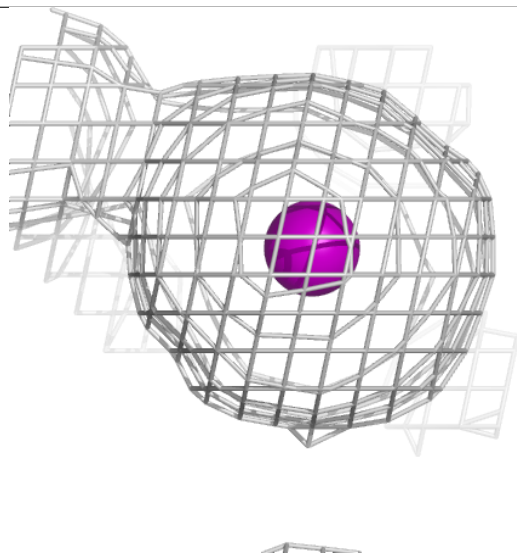
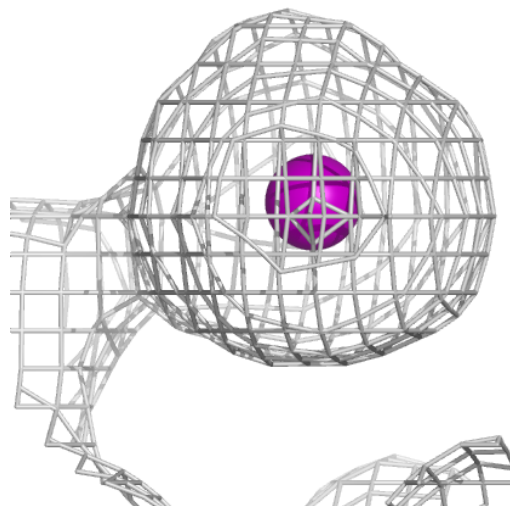

**Electron density around IOD A 602 (B):**

$2mF_o-DF_c$  (at 0.7 rmsd) in gray  
 $mF_o-DF_c$  (at 3 rmsd) in purple (negative)  
and green (positive)

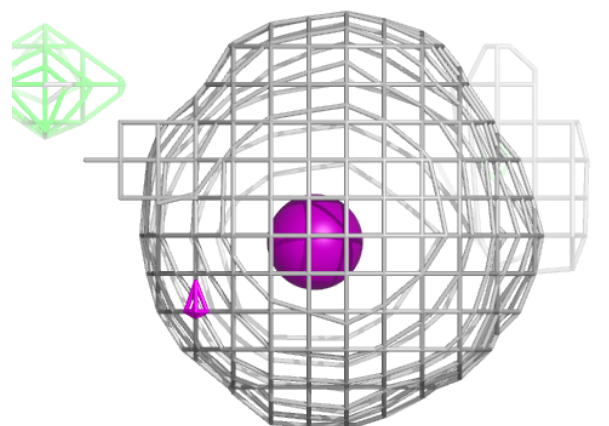
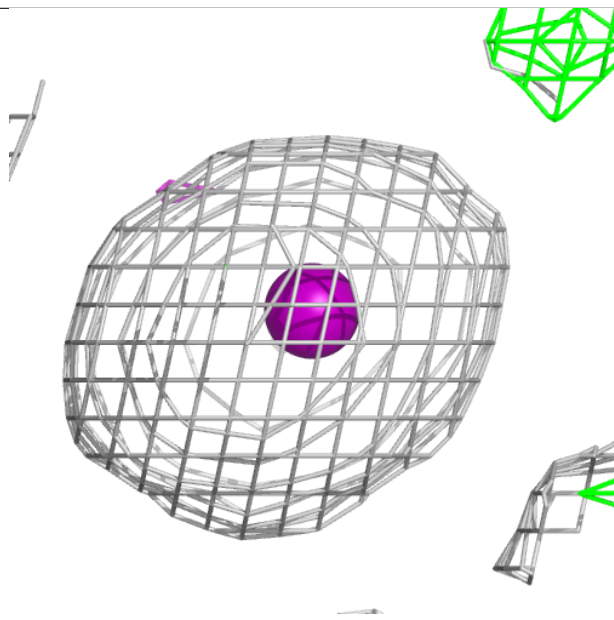
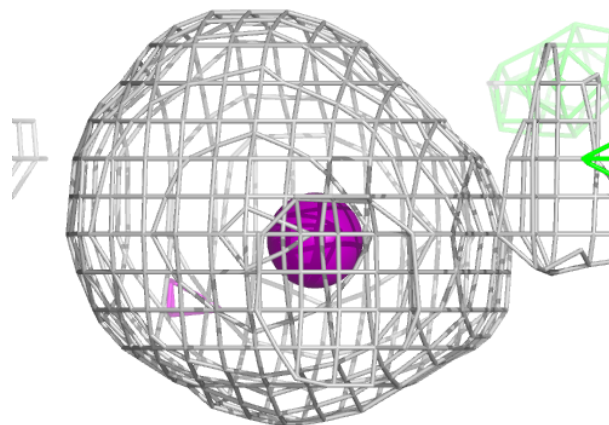

**Electron density around IOD A 619 (A):**

$2mF_o-DF_c$  (at 0.7 rmsd) in gray  
 $mF_o-DF_c$  (at 3 rmsd) in purple (negative)  
and green (positive)

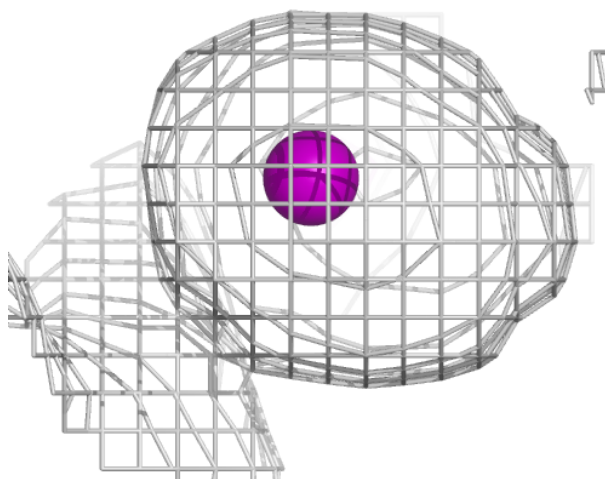
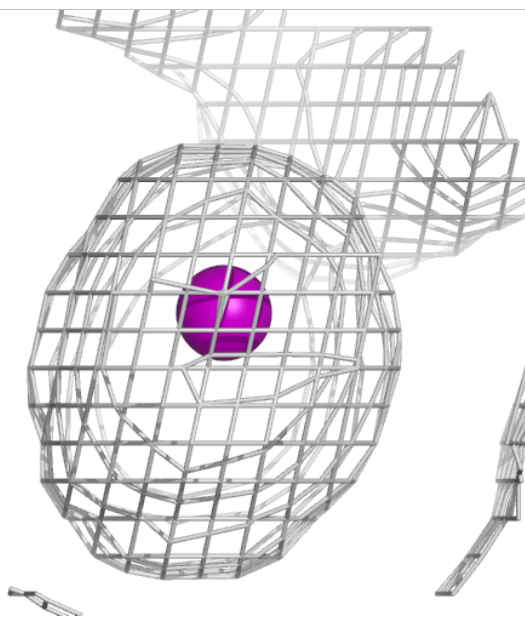
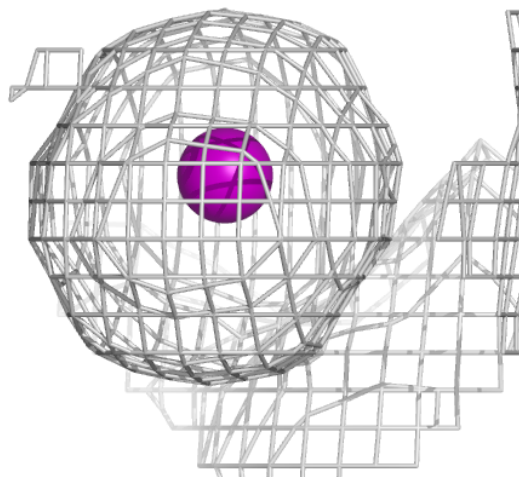

**Electron density around IOD A 619 (B):**

$2mF_o-DF_c$  (at 0.7 rmsd) in gray  
 $mF_o-DF_c$  (at 3 rmsd) in purple (negative)  
and green (positive)

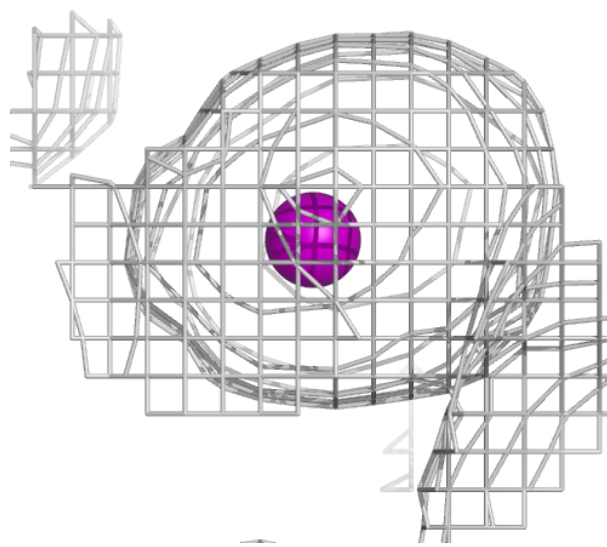
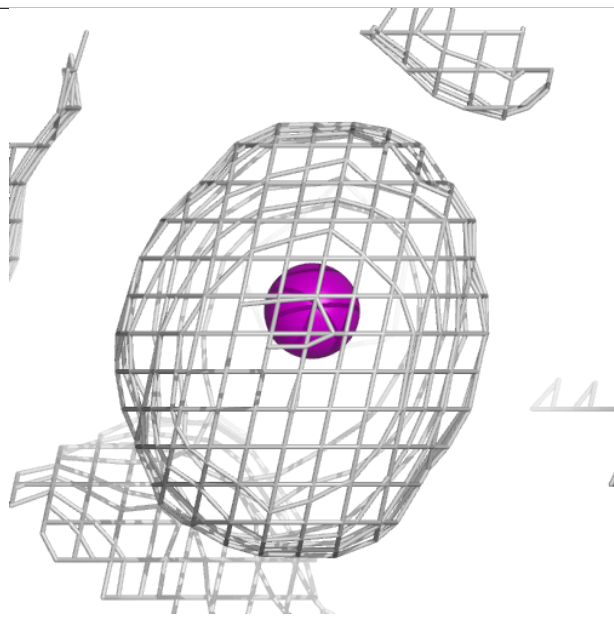
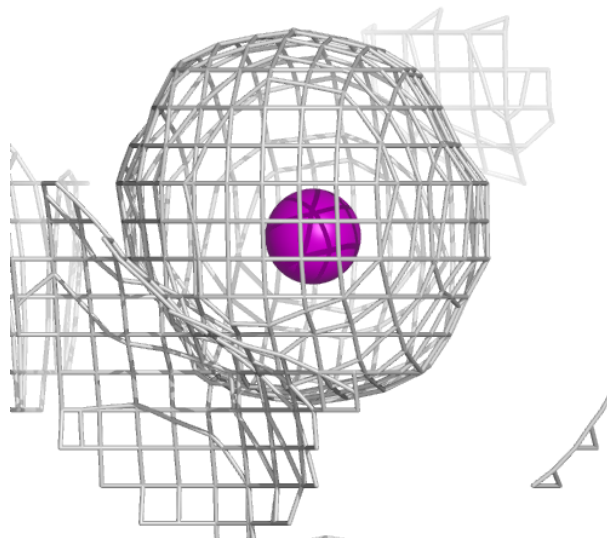

**Electron density around IOD A 602 (A):**

$2mF_o-DF_c$  (at 0.7 rmsd) in gray  
 $mF_o-DF_c$  (at 3 rmsd) in purple (negative)  
and green (positive)

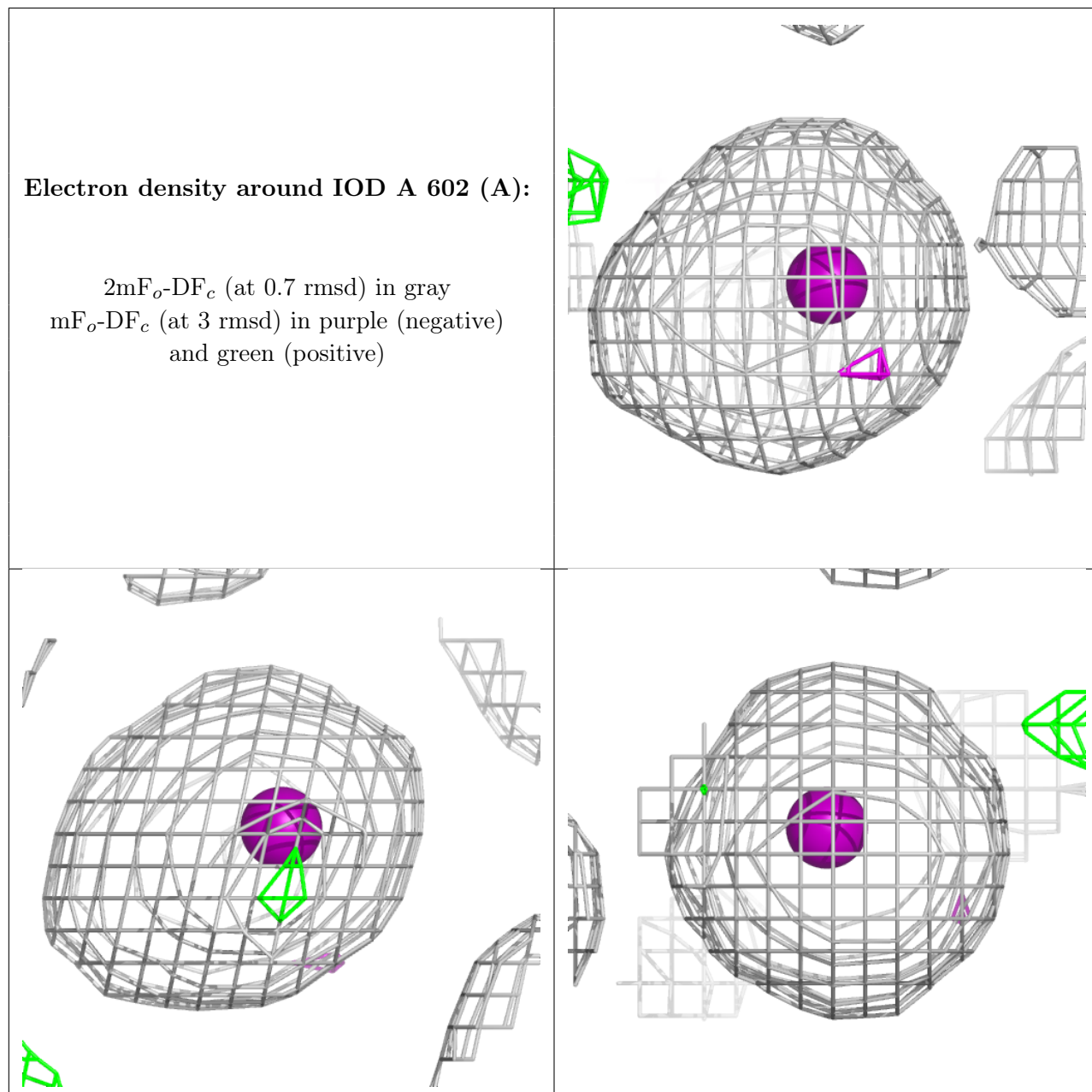

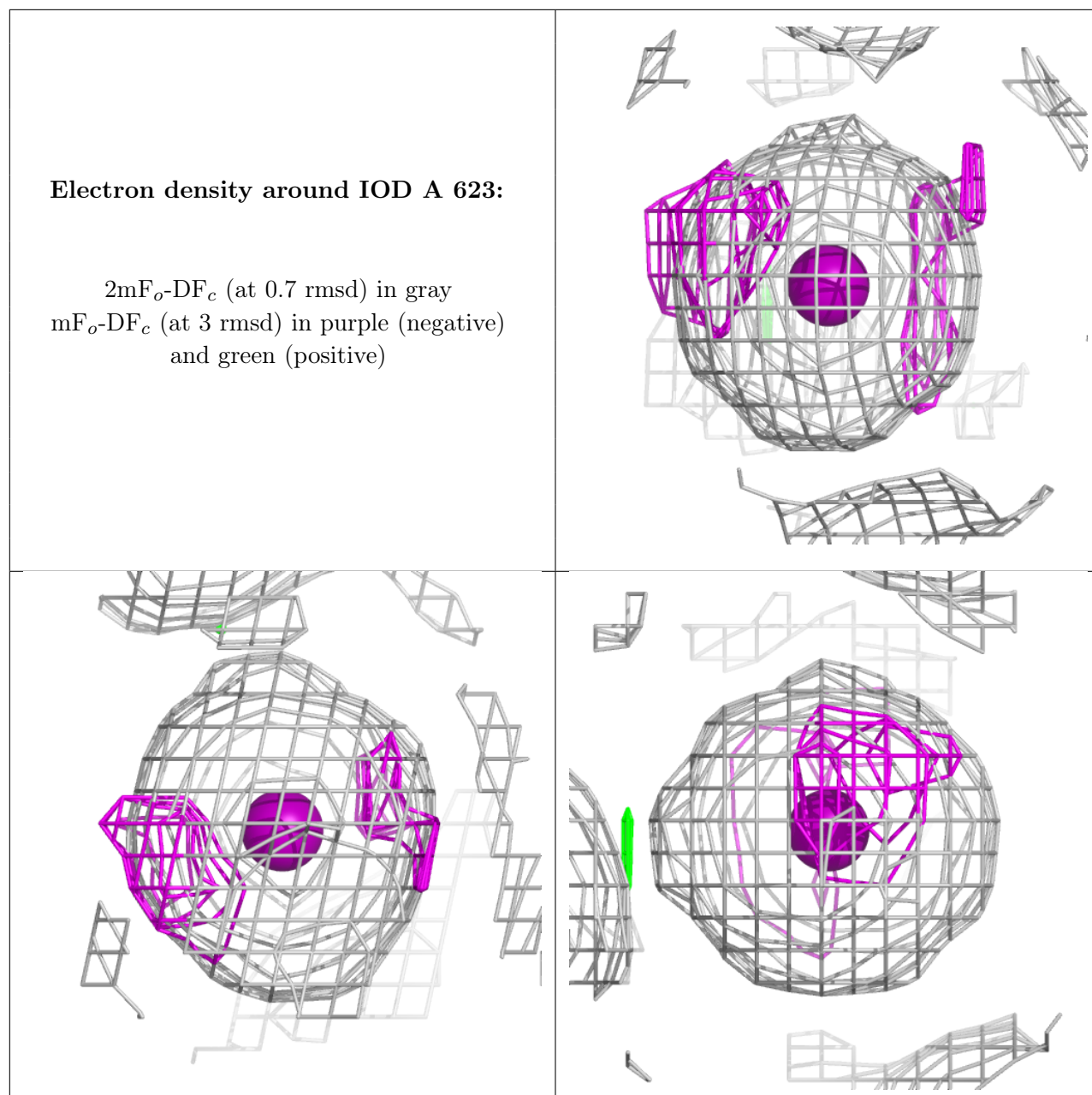

## 6.5 Other polymers ⓘ

There are no such residues in this entry.