



# Full wwPDB X-ray Structure Validation Report ⓘ

Nov 9, 2020 – 07:32 PM GMT

PDB ID : 6ZGP  
Title : Crystal structure of the quaternary ammonium Rieske monooxygenase CntA  
in complex with inhibitor MMV12 (MMV020670)  
Authors : Quareshy, M.; Shanmugam, M.; Bugg, T.D.H.; Cameron, A.; Chen, Y.  
Deposited on : 2020-06-19  
Resolution : 2.01 Å(reported)

This is a Full wwPDB X-ray Structure Validation Report for a publicly released PDB entry.

We welcome your comments at [validation@mail.wwpdb.org](mailto:validation@mail.wwpdb.org)

A user guide is available at

<https://www.wwpdb.org/validation/2017/XrayValidationReportHelp>

with specific help available everywhere you see the ⓘ symbol.

---

The following versions of software and data (see [references ⓘ](#)) were used in the production of this report:

MolProbity : 4.02b-467  
Mogul : 1.8.5 (274361), CSD as541be (2020)  
Xtriage (Phenix) : 1.13  
EDS : 2.14.6  
buster-report : 1.1.7 (2018)  
Percentile statistics : 20191225.v01 (using entries in the PDB archive December 25th 2019)  
Refmac : 5.8.0158  
CCP4 : 7.0.044 (Gargrove)  
Ideal geometry (proteins) : Engh & Huber (2001)  
Ideal geometry (DNA, RNA) : Parkinson et al. (1996)  
Validation Pipeline (wwPDB-VP) : 2.14.6

# 1 Overall quality at a glance

The following experimental techniques were used to determine the structure:

*X-RAY DIFFRACTION*

The reported resolution of this entry is 2.01 Å.

Percentile scores (ranging between 0-100) for global validation metrics of the entry are shown in the following graphic. The table shows the number of entries on which the scores are based.

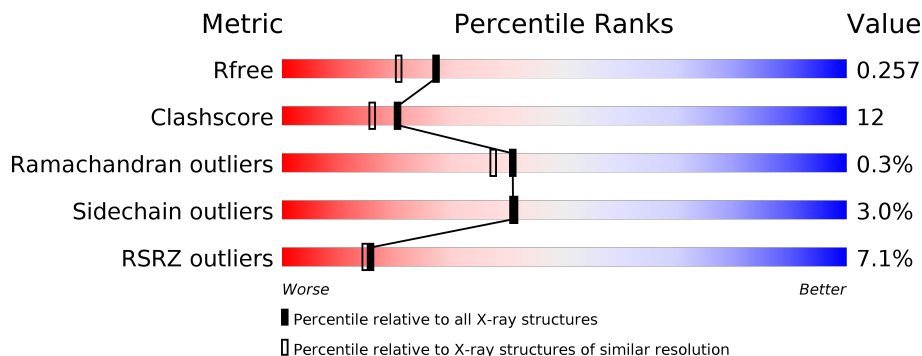

Metric	Whole archive (#Entries)	Similar resolution (#Entries, resolution range(Å))
$R_{free}$	130704	8085 (2.00-2.00)
Clashscore	141614	9178 (2.00-2.00)
Ramachandran outliers	138981	9054 (2.00-2.00)
Sidechain outliers	138945	9053 (2.00-2.00)
RSRZ outliers	127900	7900 (2.00-2.00)

The table below summarises the geometric issues observed across the polymeric chains and their fit to the electron density. The red, orange, yellow and green segments on the lower bar indicate the fraction of residues that contain outliers for  $\geq 3$ , 2, 1 and 0 types of geometric quality criteria respectively. A grey segment represents the fraction of residues that are not modelled. The numeric value for each fraction is indicated below the corresponding segment, with a dot representing fractions  $\leq 5\%$ . The upper red bar (where present) indicates the fraction of residues that have poor fit to the electron density. The numeric value is given above the bar.

Mol	Chain	Length	Quality of chain
1	A	391	 8% 70% 22% • 8%
1	B	391	 7% 65% 25% • 9%
1	C	391	 6% 68% 23% •• 9%
1	D	391	 6% 71% 19% • 8%
1	E	391	 5% 69% 21% • 8%
1	F	391	 4% 70% 21% • 8%

*Continued on next page...*

Continued from previous page...

Mol	Chain	Length	Quality of chain
1	G	391	
1	H	391	
1	I	391	
1	J	391	
1	K	391	
1	L	391	

The following table lists non-polymeric compounds, carbohydrate monomers and non-standard residues in protein, DNA, RNA chains that are outliers for geometric or electron-density-fit criteria:

Mol	Type	Chain	Res	Chirality	Geometry	Clashes	Electron density
3	FES	L	402	-	-	X	-
4	QKQ	A	403	-	-	X	X
4	QKQ	B	403	-	-	X	-
4	QKQ	I	403	-	-	-	X
4	QKQ	K	403	-	-	X	-
4	QKQ	L	403	-	-	-	X
5	EPE	B	404	-	-	-	X
5	EPE	D	404	-	-	-	X
5	EPE	F	404	-	-	-	X
5	EPE	H	404	-	-	-	X
5	EPE	J	404	-	-	-	X
5	EPE	L	404	-	-	-	X

## 2 Entry composition

There are 6 unique types of molecules in this entry. The entry contains 36907 atoms, of which 204 are hydrogens and 0 are deuteriums.

In the tables below, the ZeroOcc column contains the number of atoms modelled with zero occupancy, the AltConf column contains the number of residues with at least one atom in alternate conformation and the Trace column contains the number of residues modelled with at most 2 atoms.

- Molecule 1 is a protein called Carnitine monoxygenase oxygenase subunit.

Mol	Chain	Residues	Atoms					ZeroOcc	AltConf	Trace
			Total	C	N	O	S			
1	A	360	2917	1863	496	542	16	0	0	0
1	B	357	2895	1850	493	536	16	0	0	0
1	C	357	2897	1851	493	537	16	0	0	0
1	D	360	2917	1863	496	542	16	0	0	0
1	E	360	2917	1863	496	542	16	0	0	0
1	F	359	2911	1860	495	540	16	0	0	0
1	G	363	2945	1881	500	548	16	0	0	0
1	H	358	2904	1855	494	539	16	0	0	0
1	I	358	2903	1854	494	539	16	0	0	0
1	J	356	2887	1846	489	536	16	0	0	0
1	K	359	2910	1858	495	541	16	0	0	0
1	L	358	2904	1855	494	539	16	0	0	0

There are 240 discrepancies between the modelled and reference sequences:

Chain	Residue	Modelled	Actual	Comment	Reference
A	-19	MET	-	initiating methionine	UNP A0A059ZPP5
A	-18	GLY	-	expression tag	UNP A0A059ZPP5
A	-17	SER	-	expression tag	UNP A0A059ZPP5
A	-16	SER	-	expression tag	UNP A0A059ZPP5
A	-15	HIS	-	expression tag	UNP A0A059ZPP5

*Continued on next page...*

*Continued from previous page...*

Chain	Residue	Modelled	Actual	Comment	Reference
A	-14	HIS	-	expression tag	UNP A0A059ZPP5
A	-13	HIS	-	expression tag	UNP A0A059ZPP5
A	-12	HIS	-	expression tag	UNP A0A059ZPP5
A	-11	HIS	-	expression tag	UNP A0A059ZPP5
A	-10	HIS	-	expression tag	UNP A0A059ZPP5
A	-9	SER	-	expression tag	UNP A0A059ZPP5
A	-8	SER	-	expression tag	UNP A0A059ZPP5
A	-7	GLY	-	expression tag	UNP A0A059ZPP5
A	-6	LEU	-	expression tag	UNP A0A059ZPP5
A	-5	VAL	-	expression tag	UNP A0A059ZPP5
A	-4	PRO	-	expression tag	UNP A0A059ZPP5
A	-3	ARG	-	expression tag	UNP A0A059ZPP5
A	-2	GLY	-	expression tag	UNP A0A059ZPP5
A	-1	SER	-	expression tag	UNP A0A059ZPP5
A	0	HIS	-	expression tag	UNP A0A059ZPP5
B	-19	MET	-	initiating methionine	UNP A0A059ZPP5
B	-18	GLY	-	expression tag	UNP A0A059ZPP5
B	-17	SER	-	expression tag	UNP A0A059ZPP5
B	-16	SER	-	expression tag	UNP A0A059ZPP5
B	-15	HIS	-	expression tag	UNP A0A059ZPP5
B	-14	HIS	-	expression tag	UNP A0A059ZPP5
B	-13	HIS	-	expression tag	UNP A0A059ZPP5
B	-12	HIS	-	expression tag	UNP A0A059ZPP5
B	-11	HIS	-	expression tag	UNP A0A059ZPP5
B	-10	HIS	-	expression tag	UNP A0A059ZPP5
B	-9	SER	-	expression tag	UNP A0A059ZPP5
B	-8	SER	-	expression tag	UNP A0A059ZPP5
B	-7	GLY	-	expression tag	UNP A0A059ZPP5
B	-6	LEU	-	expression tag	UNP A0A059ZPP5
B	-5	VAL	-	expression tag	UNP A0A059ZPP5
B	-4	PRO	-	expression tag	UNP A0A059ZPP5
B	-3	ARG	-	expression tag	UNP A0A059ZPP5
B	-2	GLY	-	expression tag	UNP A0A059ZPP5
B	-1	SER	-	expression tag	UNP A0A059ZPP5
B	0	HIS	-	expression tag	UNP A0A059ZPP5
C	-19	MET	-	initiating methionine	UNP A0A059ZPP5
C	-18	GLY	-	expression tag	UNP A0A059ZPP5
C	-17	SER	-	expression tag	UNP A0A059ZPP5
C	-16	SER	-	expression tag	UNP A0A059ZPP5
C	-15	HIS	-	expression tag	UNP A0A059ZPP5
C	-14	HIS	-	expression tag	UNP A0A059ZPP5
C	-13	HIS	-	expression tag	UNP A0A059ZPP5

*Continued on next page...*

*Continued from previous page...*

Chain	Residue	Modelled	Actual	Comment	Reference
C	-12	HIS	-	expression tag	UNP A0A059ZPP5
C	-11	HIS	-	expression tag	UNP A0A059ZPP5
C	-10	HIS	-	expression tag	UNP A0A059ZPP5
C	-9	SER	-	expression tag	UNP A0A059ZPP5
C	-8	SER	-	expression tag	UNP A0A059ZPP5
C	-7	GLY	-	expression tag	UNP A0A059ZPP5
C	-6	LEU	-	expression tag	UNP A0A059ZPP5
C	-5	VAL	-	expression tag	UNP A0A059ZPP5
C	-4	PRO	-	expression tag	UNP A0A059ZPP5
C	-3	ARG	-	expression tag	UNP A0A059ZPP5
C	-2	GLY	-	expression tag	UNP A0A059ZPP5
C	-1	SER	-	expression tag	UNP A0A059ZPP5
C	0	HIS	-	expression tag	UNP A0A059ZPP5
D	-19	MET	-	initiating methionine	UNP A0A059ZPP5
D	-18	GLY	-	expression tag	UNP A0A059ZPP5
D	-17	SER	-	expression tag	UNP A0A059ZPP5
D	-16	SER	-	expression tag	UNP A0A059ZPP5
D	-15	HIS	-	expression tag	UNP A0A059ZPP5
D	-14	HIS	-	expression tag	UNP A0A059ZPP5
D	-13	HIS	-	expression tag	UNP A0A059ZPP5
D	-12	HIS	-	expression tag	UNP A0A059ZPP5
D	-11	HIS	-	expression tag	UNP A0A059ZPP5
D	-10	HIS	-	expression tag	UNP A0A059ZPP5
D	-9	SER	-	expression tag	UNP A0A059ZPP5
D	-8	SER	-	expression tag	UNP A0A059ZPP5
D	-7	GLY	-	expression tag	UNP A0A059ZPP5
D	-6	LEU	-	expression tag	UNP A0A059ZPP5
D	-5	VAL	-	expression tag	UNP A0A059ZPP5
D	-4	PRO	-	expression tag	UNP A0A059ZPP5
D	-3	ARG	-	expression tag	UNP A0A059ZPP5
D	-2	GLY	-	expression tag	UNP A0A059ZPP5
D	-1	SER	-	expression tag	UNP A0A059ZPP5
D	0	HIS	-	expression tag	UNP A0A059ZPP5
E	-19	MET	-	initiating methionine	UNP A0A059ZPP5
E	-18	GLY	-	expression tag	UNP A0A059ZPP5
E	-17	SER	-	expression tag	UNP A0A059ZPP5
E	-16	SER	-	expression tag	UNP A0A059ZPP5
E	-15	HIS	-	expression tag	UNP A0A059ZPP5
E	-14	HIS	-	expression tag	UNP A0A059ZPP5
E	-13	HIS	-	expression tag	UNP A0A059ZPP5
E	-12	HIS	-	expression tag	UNP A0A059ZPP5
E	-11	HIS	-	expression tag	UNP A0A059ZPP5

*Continued on next page...*

*Continued from previous page...*

Chain	Residue	Modelled	Actual	Comment	Reference
E	-10	HIS	-	expression tag	UNP A0A059ZPP5
E	-9	SER	-	expression tag	UNP A0A059ZPP5
E	-8	SER	-	expression tag	UNP A0A059ZPP5
E	-7	GLY	-	expression tag	UNP A0A059ZPP5
E	-6	LEU	-	expression tag	UNP A0A059ZPP5
E	-5	VAL	-	expression tag	UNP A0A059ZPP5
E	-4	PRO	-	expression tag	UNP A0A059ZPP5
E	-3	ARG	-	expression tag	UNP A0A059ZPP5
E	-2	GLY	-	expression tag	UNP A0A059ZPP5
E	-1	SER	-	expression tag	UNP A0A059ZPP5
E	0	HIS	-	expression tag	UNP A0A059ZPP5
F	-19	MET	-	initiating methionine	UNP A0A059ZPP5
F	-18	GLY	-	expression tag	UNP A0A059ZPP5
F	-17	SER	-	expression tag	UNP A0A059ZPP5
F	-16	SER	-	expression tag	UNP A0A059ZPP5
F	-15	HIS	-	expression tag	UNP A0A059ZPP5
F	-14	HIS	-	expression tag	UNP A0A059ZPP5
F	-13	HIS	-	expression tag	UNP A0A059ZPP5
F	-12	HIS	-	expression tag	UNP A0A059ZPP5
F	-11	HIS	-	expression tag	UNP A0A059ZPP5
F	-10	HIS	-	expression tag	UNP A0A059ZPP5
F	-9	SER	-	expression tag	UNP A0A059ZPP5
F	-8	SER	-	expression tag	UNP A0A059ZPP5
F	-7	GLY	-	expression tag	UNP A0A059ZPP5
F	-6	LEU	-	expression tag	UNP A0A059ZPP5
F	-5	VAL	-	expression tag	UNP A0A059ZPP5
F	-4	PRO	-	expression tag	UNP A0A059ZPP5
F	-3	ARG	-	expression tag	UNP A0A059ZPP5
F	-2	GLY	-	expression tag	UNP A0A059ZPP5
F	-1	SER	-	expression tag	UNP A0A059ZPP5
F	0	HIS	-	expression tag	UNP A0A059ZPP5
G	-19	MET	-	initiating methionine	UNP A0A059ZPP5
G	-18	GLY	-	expression tag	UNP A0A059ZPP5
G	-17	SER	-	expression tag	UNP A0A059ZPP5
G	-16	SER	-	expression tag	UNP A0A059ZPP5
G	-15	HIS	-	expression tag	UNP A0A059ZPP5
G	-14	HIS	-	expression tag	UNP A0A059ZPP5
G	-13	HIS	-	expression tag	UNP A0A059ZPP5
G	-12	HIS	-	expression tag	UNP A0A059ZPP5
G	-11	HIS	-	expression tag	UNP A0A059ZPP5
G	-10	HIS	-	expression tag	UNP A0A059ZPP5
G	-9	SER	-	expression tag	UNP A0A059ZPP5

*Continued on next page...*

*Continued from previous page...*

Chain	Residue	Modelled	Actual	Comment	Reference
G	-8	SER	-	expression tag	UNP A0A059ZPP5
G	-7	GLY	-	expression tag	UNP A0A059ZPP5
G	-6	LEU	-	expression tag	UNP A0A059ZPP5
G	-5	VAL	-	expression tag	UNP A0A059ZPP5
G	-4	PRO	-	expression tag	UNP A0A059ZPP5
G	-3	ARG	-	expression tag	UNP A0A059ZPP5
G	-2	GLY	-	expression tag	UNP A0A059ZPP5
G	-1	SER	-	expression tag	UNP A0A059ZPP5
G	0	HIS	-	expression tag	UNP A0A059ZPP5
H	-19	MET	-	initiating methionine	UNP A0A059ZPP5
H	-18	GLY	-	expression tag	UNP A0A059ZPP5
H	-17	SER	-	expression tag	UNP A0A059ZPP5
H	-16	SER	-	expression tag	UNP A0A059ZPP5
H	-15	HIS	-	expression tag	UNP A0A059ZPP5
H	-14	HIS	-	expression tag	UNP A0A059ZPP5
H	-13	HIS	-	expression tag	UNP A0A059ZPP5
H	-12	HIS	-	expression tag	UNP A0A059ZPP5
H	-11	HIS	-	expression tag	UNP A0A059ZPP5
H	-10	HIS	-	expression tag	UNP A0A059ZPP5
H	-9	SER	-	expression tag	UNP A0A059ZPP5
H	-8	SER	-	expression tag	UNP A0A059ZPP5
H	-7	GLY	-	expression tag	UNP A0A059ZPP5
H	-6	LEU	-	expression tag	UNP A0A059ZPP5
H	-5	VAL	-	expression tag	UNP A0A059ZPP5
H	-4	PRO	-	expression tag	UNP A0A059ZPP5
H	-3	ARG	-	expression tag	UNP A0A059ZPP5
H	-2	GLY	-	expression tag	UNP A0A059ZPP5
H	-1	SER	-	expression tag	UNP A0A059ZPP5
H	0	HIS	-	expression tag	UNP A0A059ZPP5
I	-19	MET	-	initiating methionine	UNP A0A059ZPP5
I	-18	GLY	-	expression tag	UNP A0A059ZPP5
I	-17	SER	-	expression tag	UNP A0A059ZPP5
I	-16	SER	-	expression tag	UNP A0A059ZPP5
I	-15	HIS	-	expression tag	UNP A0A059ZPP5
I	-14	HIS	-	expression tag	UNP A0A059ZPP5
I	-13	HIS	-	expression tag	UNP A0A059ZPP5
I	-12	HIS	-	expression tag	UNP A0A059ZPP5
I	-11	HIS	-	expression tag	UNP A0A059ZPP5
I	-10	HIS	-	expression tag	UNP A0A059ZPP5
I	-9	SER	-	expression tag	UNP A0A059ZPP5
I	-8	SER	-	expression tag	UNP A0A059ZPP5
I	-7	GLY	-	expression tag	UNP A0A059ZPP5

*Continued on next page...*



*Continued from previous page...*

Chain	Residue	Modelled	Actual	Comment	Reference
I	-6	LEU	-	expression tag	UNP A0A059ZPP5
I	-5	VAL	-	expression tag	UNP A0A059ZPP5
I	-4	PRO	-	expression tag	UNP A0A059ZPP5
I	-3	ARG	-	expression tag	UNP A0A059ZPP5
I	-2	GLY	-	expression tag	UNP A0A059ZPP5
I	-1	SER	-	expression tag	UNP A0A059ZPP5
I	0	HIS	-	expression tag	UNP A0A059ZPP5
J	-19	MET	-	initiating methionine	UNP A0A059ZPP5
J	-18	GLY	-	expression tag	UNP A0A059ZPP5
J	-17	SER	-	expression tag	UNP A0A059ZPP5
J	-16	SER	-	expression tag	UNP A0A059ZPP5
J	-15	HIS	-	expression tag	UNP A0A059ZPP5
J	-14	HIS	-	expression tag	UNP A0A059ZPP5
J	-13	HIS	-	expression tag	UNP A0A059ZPP5
J	-12	HIS	-	expression tag	UNP A0A059ZPP5
J	-11	HIS	-	expression tag	UNP A0A059ZPP5
J	-10	HIS	-	expression tag	UNP A0A059ZPP5
J	-9	SER	-	expression tag	UNP A0A059ZPP5
J	-8	SER	-	expression tag	UNP A0A059ZPP5
J	-7	GLY	-	expression tag	UNP A0A059ZPP5
J	-6	LEU	-	expression tag	UNP A0A059ZPP5
J	-5	VAL	-	expression tag	UNP A0A059ZPP5
J	-4	PRO	-	expression tag	UNP A0A059ZPP5
J	-3	ARG	-	expression tag	UNP A0A059ZPP5
J	-2	GLY	-	expression tag	UNP A0A059ZPP5
J	-1	SER	-	expression tag	UNP A0A059ZPP5
J	0	HIS	-	expression tag	UNP A0A059ZPP5
K	-19	MET	-	initiating methionine	UNP A0A059ZPP5
K	-18	GLY	-	expression tag	UNP A0A059ZPP5
K	-17	SER	-	expression tag	UNP A0A059ZPP5
K	-16	SER	-	expression tag	UNP A0A059ZPP5
K	-15	HIS	-	expression tag	UNP A0A059ZPP5
K	-14	HIS	-	expression tag	UNP A0A059ZPP5
K	-13	HIS	-	expression tag	UNP A0A059ZPP5
K	-12	HIS	-	expression tag	UNP A0A059ZPP5
K	-11	HIS	-	expression tag	UNP A0A059ZPP5
K	-10	HIS	-	expression tag	UNP A0A059ZPP5
K	-9	SER	-	expression tag	UNP A0A059ZPP5
K	-8	SER	-	expression tag	UNP A0A059ZPP5
K	-7	GLY	-	expression tag	UNP A0A059ZPP5
K	-6	LEU	-	expression tag	UNP A0A059ZPP5
K	-5	VAL	-	expression tag	UNP A0A059ZPP5

*Continued on next page...*

*Continued from previous page...*

Chain	Residue	Modelled	Actual	Comment	Reference
K	-4	PRO	-	expression tag	UNP A0A059ZPP5
K	-3	ARG	-	expression tag	UNP A0A059ZPP5
K	-2	GLY	-	expression tag	UNP A0A059ZPP5
K	-1	SER	-	expression tag	UNP A0A059ZPP5
K	0	HIS	-	expression tag	UNP A0A059ZPP5
L	-19	MET	-	initiating methionine	UNP A0A059ZPP5
L	-18	GLY	-	expression tag	UNP A0A059ZPP5
L	-17	SER	-	expression tag	UNP A0A059ZPP5
L	-16	SER	-	expression tag	UNP A0A059ZPP5
L	-15	HIS	-	expression tag	UNP A0A059ZPP5
L	-14	HIS	-	expression tag	UNP A0A059ZPP5
L	-13	HIS	-	expression tag	UNP A0A059ZPP5
L	-12	HIS	-	expression tag	UNP A0A059ZPP5
L	-11	HIS	-	expression tag	UNP A0A059ZPP5
L	-10	HIS	-	expression tag	UNP A0A059ZPP5
L	-9	SER	-	expression tag	UNP A0A059ZPP5
L	-8	SER	-	expression tag	UNP A0A059ZPP5
L	-7	GLY	-	expression tag	UNP A0A059ZPP5
L	-6	LEU	-	expression tag	UNP A0A059ZPP5
L	-5	VAL	-	expression tag	UNP A0A059ZPP5
L	-4	PRO	-	expression tag	UNP A0A059ZPP5
L	-3	ARG	-	expression tag	UNP A0A059ZPP5
L	-2	GLY	-	expression tag	UNP A0A059ZPP5
L	-1	SER	-	expression tag	UNP A0A059ZPP5
L	0	HIS	-	expression tag	UNP A0A059ZPP5

- Molecule 2 is FE (III) ION (three-letter code: FE) (formula: Fe) (labeled as "Ligand of Interest" by author).

Mol	Chain	Residues	Atoms	ZeroOcc	AltConf
2	G	1	Total Fe 1 1	0	0
2	J	1	Total Fe 1 1	0	0
2	D	1	Total Fe 1 1	0	0
2	K	1	Total Fe 1 1	0	0
2	E	1	Total Fe 1 1	0	0
2	H	1	Total Fe 1 1	0	0

*Continued on next page...*

Continued from previous page...

Mol	Chain	Residues	Atoms	ZeroOcc	AltConf
2	B	1	Total Fe 1 1	0	0
2	I	1	Total Fe 1 1	0	0
2	C	1	Total Fe 1 1	0	0
2	A	1	Total Fe 1 1	0	0
2	L	1	Total Fe 1 1	0	0
2	F	1	Total Fe 1 1	0	0

- Molecule 3 is FE2/S2 (INORGANIC) CLUSTER (three-letter code: FES) (formula: Fe<sub>2</sub>S<sub>2</sub>) (labeled as "Ligand of Interest" by author).

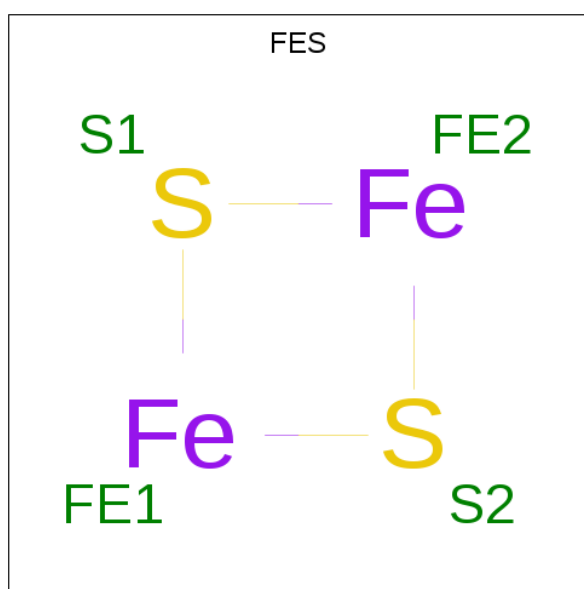

Mol	Chain	Residues	Atoms	ZeroOcc	AltConf
3	A	1	Total Fe S 4 2 2	0	0
3	B	1	Total Fe S 4 2 2	0	0
3	C	1	Total Fe S 4 2 2	0	0
3	D	1	Total Fe S 4 2 2	0	0
3	E	1	Total Fe S 4 2 2	0	0

Continued on next page...

Continued from previous page...

Mol	Chain	Residues	Atoms			ZeroOcc	AltConf
			Total	Fe	S		
3	F	1	Total 4	Fe 2	S 2	0	0
3	G	1	Total 4	Fe 2	S 2	0	0
3	H	1	Total 4	Fe 2	S 2	0	0
3	I	1	Total 4	Fe 2	S 2	0	0
3	J	1	Total 4	Fe 2	S 2	0	0
3	K	1	Total 4	Fe 2	S 2	0	0
3	L	1	Total 4	Fe 2	S 2	0	0

- Molecule 4 is {N}-(3-imidazol-1-ylpropyl)-8-(4-methoxyphenyl)-1,6-naphthyridine-2-carboxamide (three-letter code: QKQ) (formula: C<sub>22</sub>H<sub>21</sub>N<sub>5</sub>O<sub>2</sub>) (labeled as "Ligand of Interest" by author).

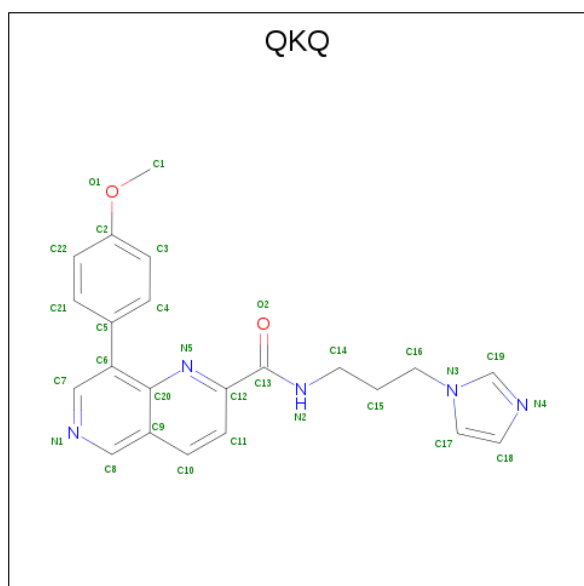

Mol	Chain	Residues	Atoms				ZeroOcc	AltConf
			Total	C	N	O		
4	A	1	Total 29	C 22	N 5	O 2	0	0
4	B	1	Total 29	C 22	N 5	O 2	0	0
4	C	1	Total 29	C 22	N 5	O 2	0	0

Continued on next page...

Continued from previous page...

Mol	Chain	Residues	Atoms				ZeroOcc	AltConf
			Total	C	N	O		
4	D	1	Total 29	C 22	N 5	O 2	0	0
4	E	1	Total 29	C 22	N 5	O 2	0	0
4	F	1	Total 29	C 22	N 5	O 2	0	0
4	G	1	Total 29	C 22	N 5	O 2	0	0
4	H	1	Total 29	C 22	N 5	O 2	0	0
4	I	1	Total 29	C 22	N 5	O 2	0	0
4	J	1	Total 29	C 22	N 5	O 2	0	0
4	K	1	Total 29	C 22	N 5	O 2	0	0
4	L	1	Total 29	C 22	N 5	O 2	0	0

- Molecule 5 is 4-(2-HYDROXYETHYL)-1-PIPERAZINE ETHANESULFONIC ACID (three-letter code: EPE) (formula: C<sub>8</sub>H<sub>18</sub>N<sub>2</sub>O<sub>4</sub>S).

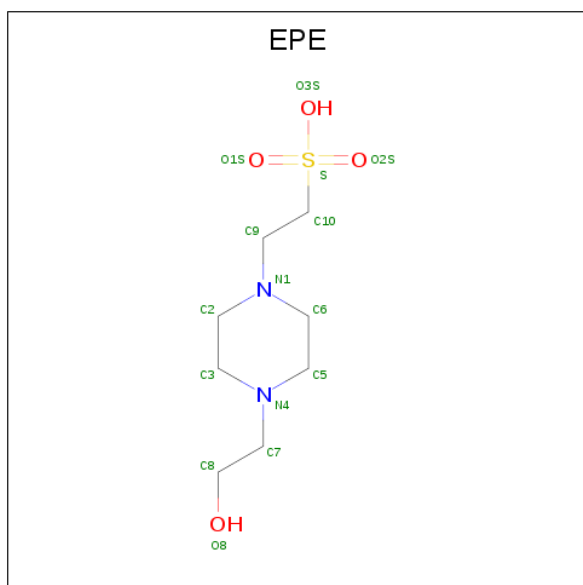

Mol	Chain	Residues	Atoms					ZeroOcc	AltConf	
			Total	C	H	N	O			S
5	A	1	Total 32	C 8	H 17	N 2	O 4	S 1	0	0
5	B	1	Total 32	C 8	H 17	N 2	O 4	S 1	0	0

Continued on next page...

*Continued from previous page...*

Mol	Chain	Residues	Atoms					ZeroOcc	AltConf	
5	C	1	Total	C	H	N	O	S	0	0
			32	8	17	2	4	1		
5	D	1	Total	C	H	N	O	S	0	0
			32	8	17	2	4	1		
5	E	1	Total	C	H	N	O	S	0	0
			32	8	17	2	4	1		
5	F	1	Total	C	H	N	O	S	0	0
			32	8	17	2	4	1		
5	G	1	Total	C	H	N	O	S	0	0
			32	8	17	2	4	1		
5	H	1	Total	C	H	N	O	S	0	0
			32	8	17	2	4	1		
5	I	1	Total	C	H	N	O	S	0	0
			32	8	17	2	4	1		
5	J	1	Total	C	H	N	O	S	0	0
			32	8	17	2	4	1		
5	K	1	Total	C	H	N	O	S	0	0
			32	8	17	2	4	1		
5	L	1	Total	C	H	N	O	S	0	0
			32	8	17	2	4	1		

- Molecule 6 is water.

Mol	Chain	Residues	Atoms		ZeroOcc	AltConf
6	A	75	Total	O	0	0
			75	75		
6	B	87	Total	O	0	0
			87	87		
6	C	51	Total	O	0	0
			51	51		
6	D	99	Total	O	0	0
			99	99		
6	E	103	Total	O	0	0
			103	103		
6	F	122	Total	O	0	0
			122	122		
6	G	147	Total	O	0	0
			147	147		
6	H	135	Total	O	0	0
			135	135		
6	I	113	Total	O	0	0
			113	113		

*Continued on next page...*

*Continued from previous page...*

<b>Mol</b>	<b>Chain</b>	<b>Residues</b>	<b>Atoms</b>		<b>ZeroOcc</b>	<b>AltConf</b>
6	J	105	Total 105	O 105	0	0
6	K	79	Total 79	O 79	0	0
6	L	92	Total 92	O 92	0	0

### 3 Residue-property plots

These plots are drawn for all protein, RNA, DNA and oligosaccharide chains in the entry. The first graphic for a chain summarises the proportions of the various outlier classes displayed in the second graphic. The second graphic shows the sequence view annotated by issues in geometry and electron density. Residues are color-coded according to the number of geometric quality criteria for which they contain at least one outlier: green = 0, yellow = 1, orange = 2 and red = 3 or more. A red dot above a residue indicates a poor fit to the electron density ( $RSRZ > 2$ ). Stretches of 2 or more consecutive residues without any outlier are shown as a green connector. Residues present in the sample, but not in the model, are shown in grey.

- Molecule 1: Carnitine monooxygenase oxygenase subunit

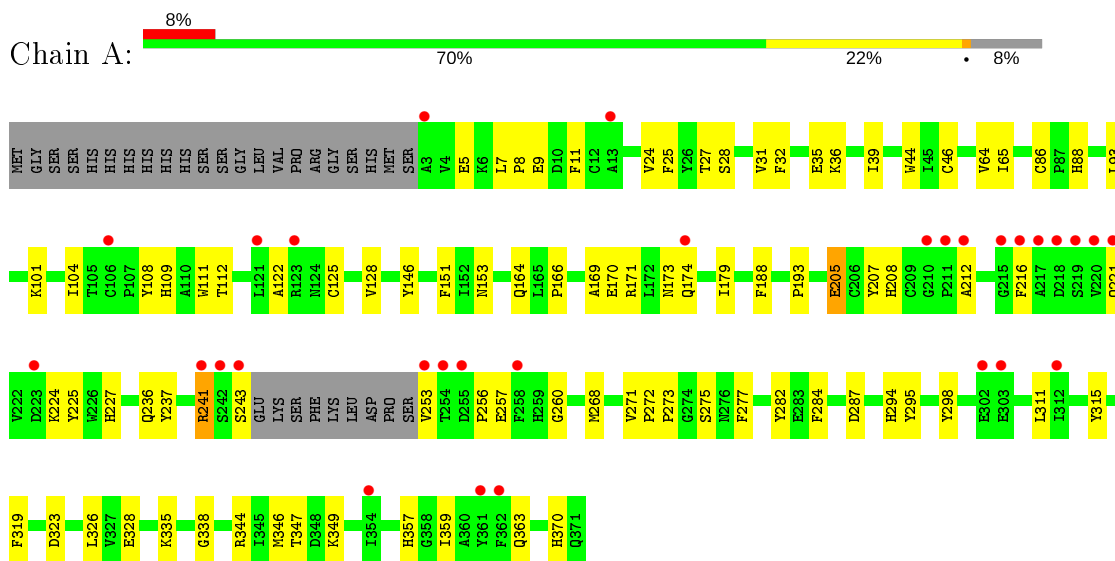

- Molecule 1: Carnitine monooxygenase oxygenase subunit

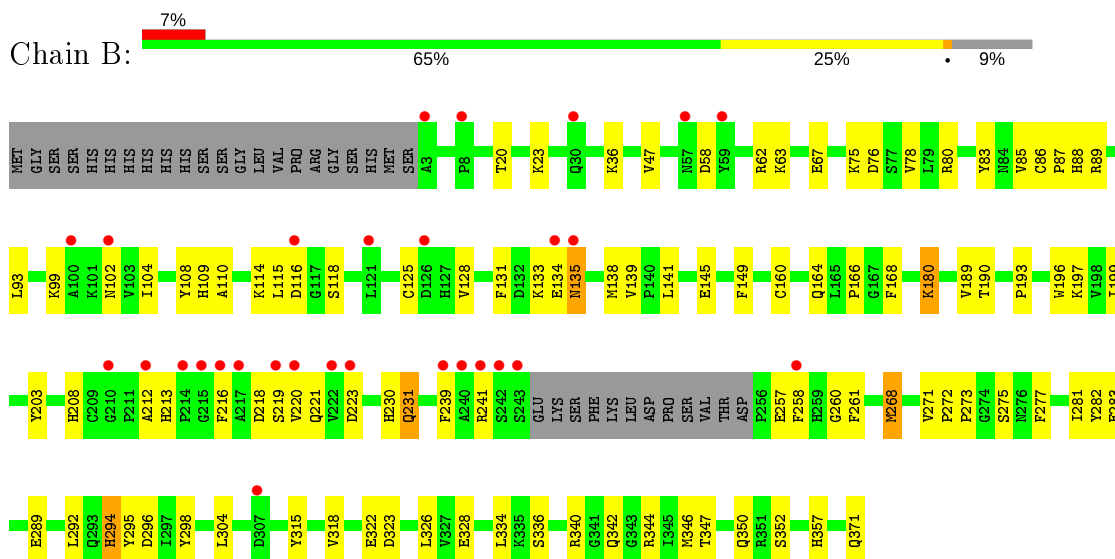

- Molecule 1: Carnitine monooxygenase oxygenase subunit



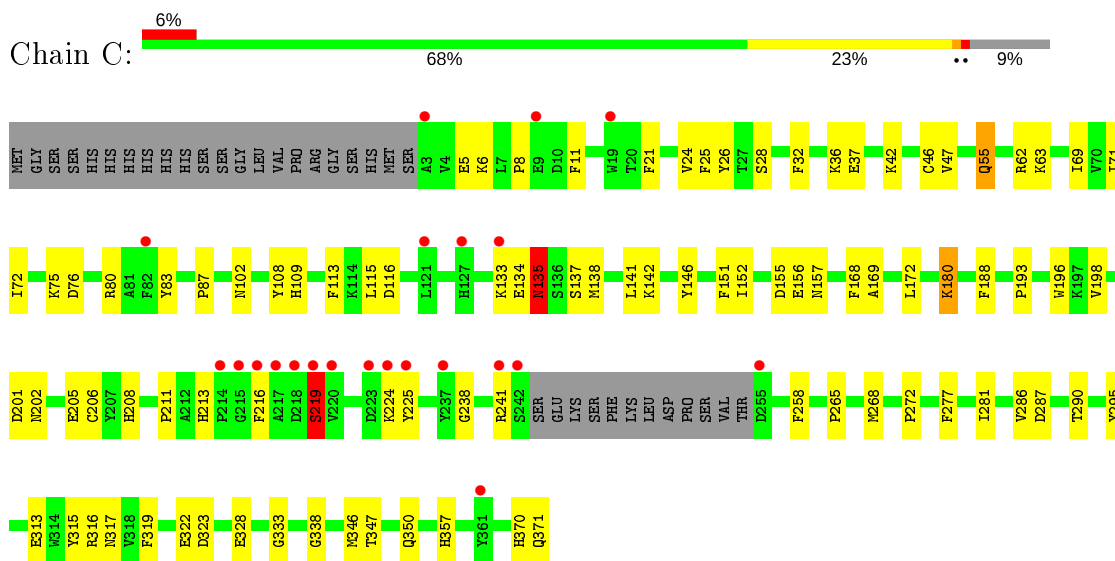

• Molecule 1: Carnitine monooxygenase oxygenase subunit

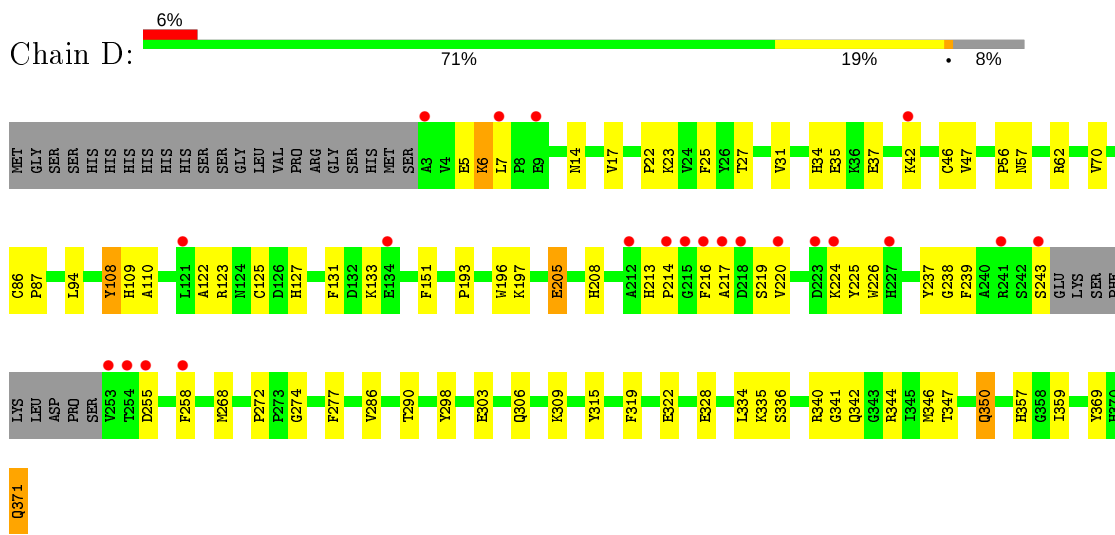

• Molecule 1: Carnitine monooxygenase oxygenase subunit

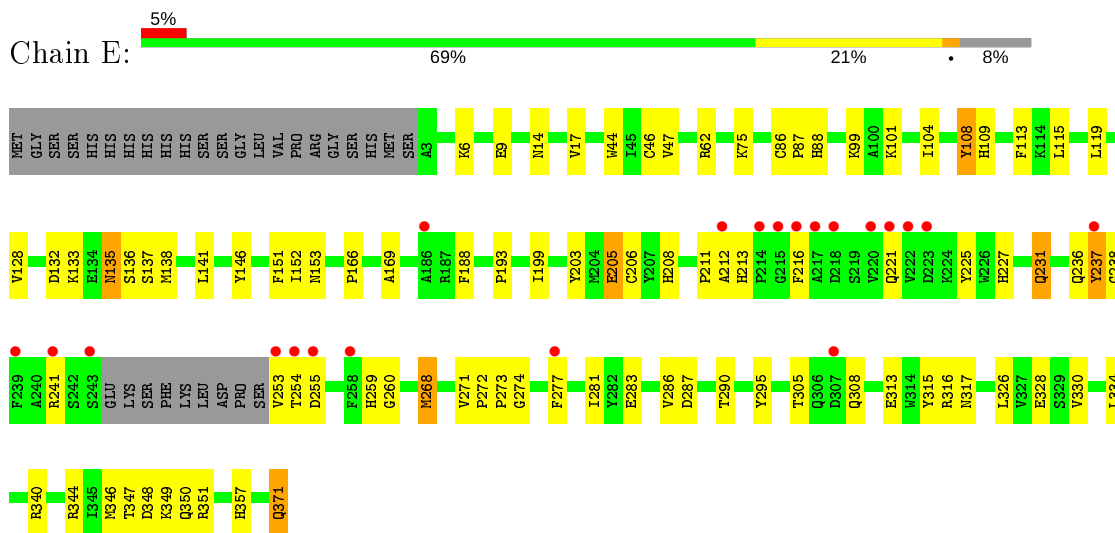

- Molecule 1: Carnitine monooxygenase oxygenase subunit

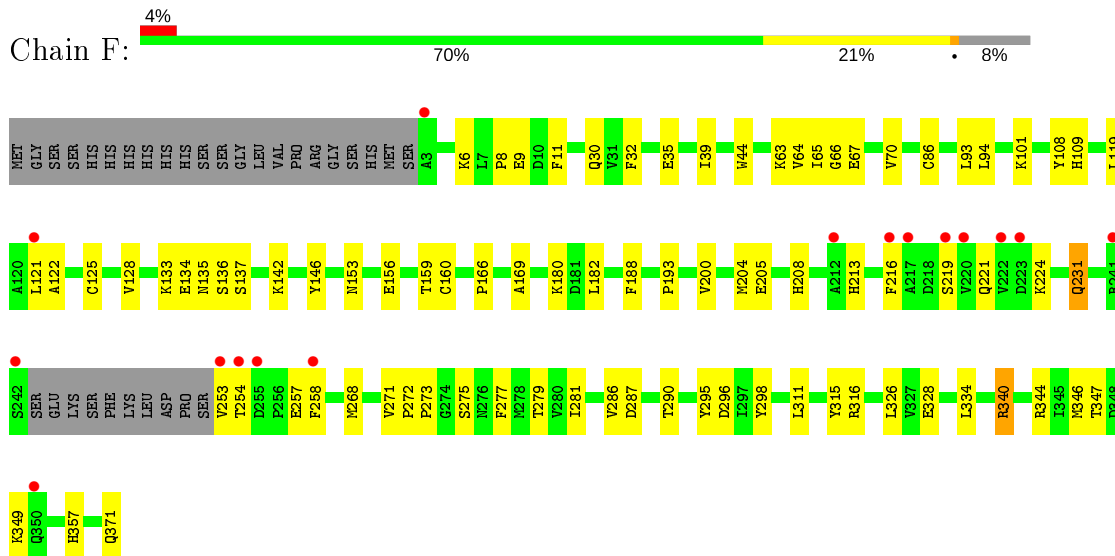

- Molecule 1: Carnitine monooxygenase oxygenase subunit

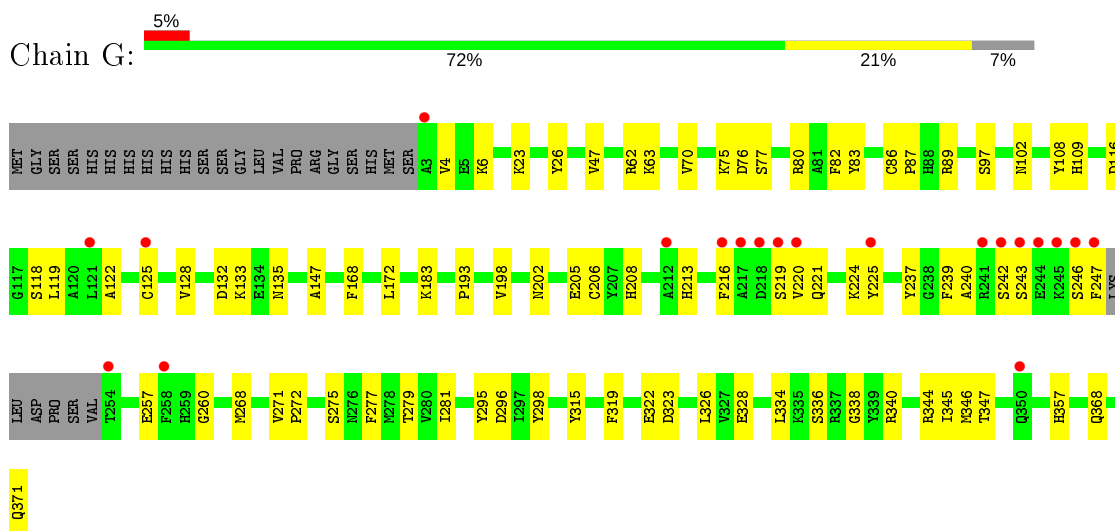

- Molecule 1: Carnitine monooxygenase oxygenase subunit

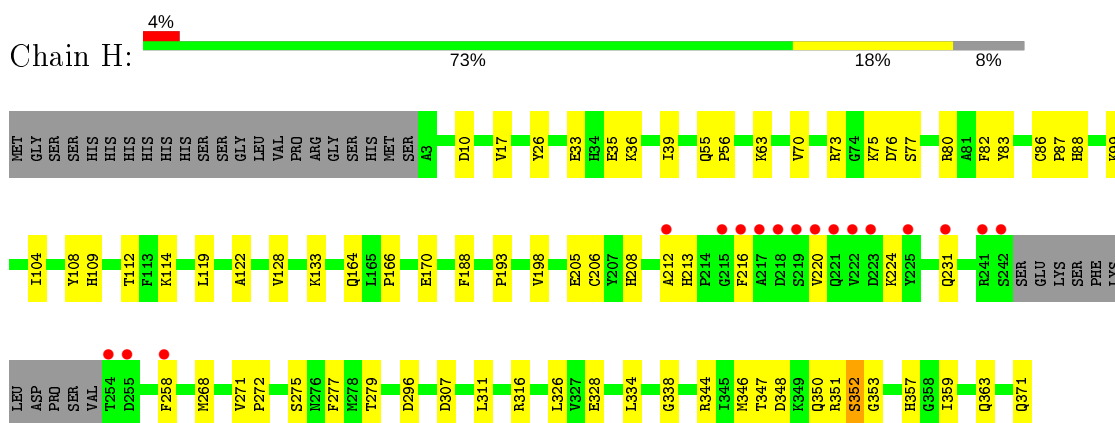

- Molecule 1: Carnitine monooxygenase oxygenase subunit

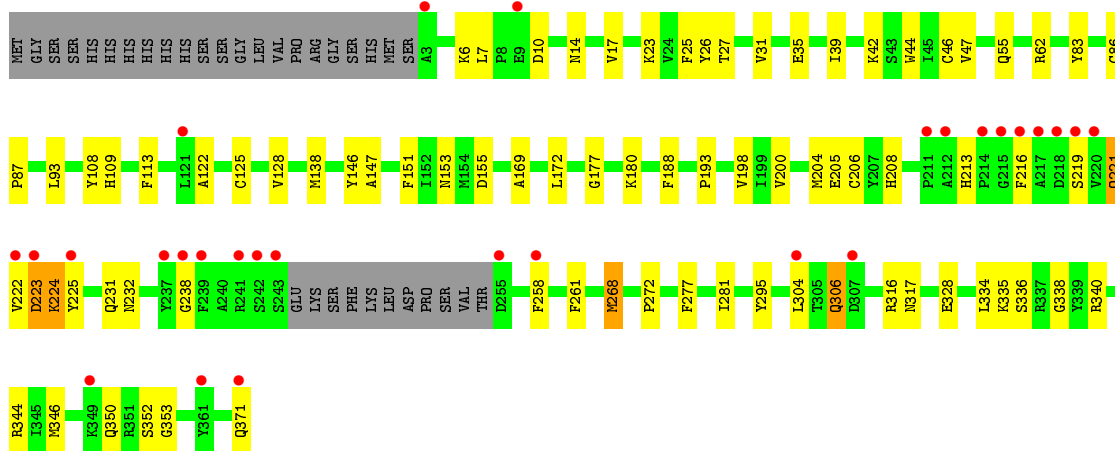

• Molecule 1: Carnitine monooxygenase oxygenase subunit

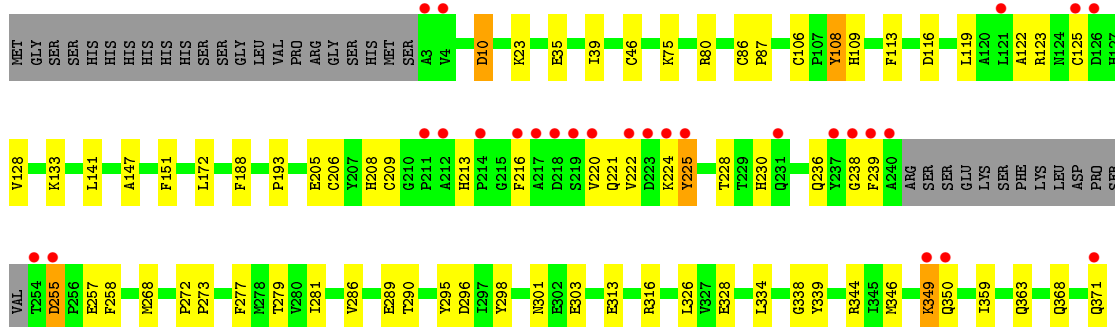

• Molecule 1: Carnitine monooxygenase oxygenase subunit

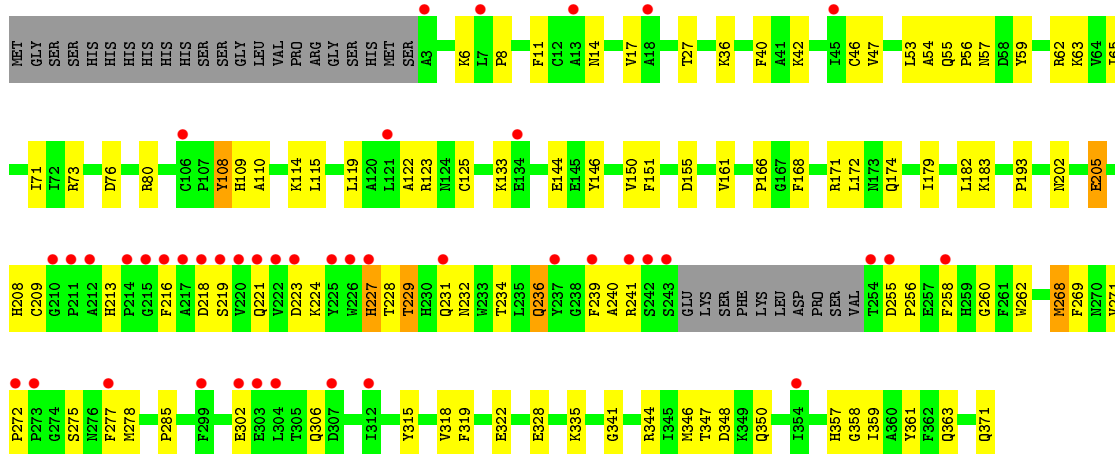

• Molecule 1: Carnitine monooxygenase oxygenase subunit

Chain L:  7% 69% 21% 8%

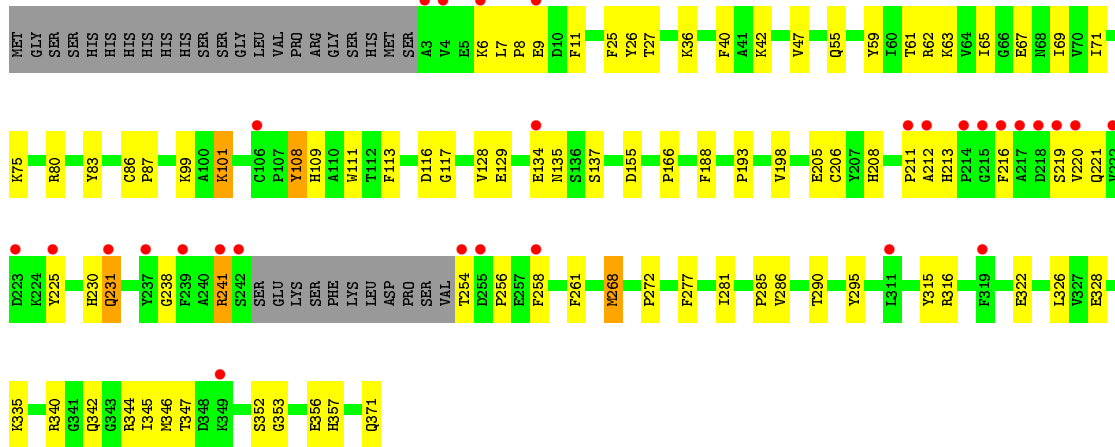

## 4 Data and refinement statistics i

Property	Value	Source
Space group	P 1 21 1	Depositor
Cell constants a, b, c, $\alpha$ , $\beta$ , $\gamma$	91.07Å 173.77Å 157.29Å 90.00° 90.15° 90.00°	Depositor
Resolution (Å)	80.66 – 2.01 80.66 – 2.01	Depositor EDS
% Data completeness (in resolution range)	99.4 (80.66-2.01) 99.7 (80.66-2.01)	Depositor EDS
$R_{merge}$	0.17	Depositor
$R_{sym}$	(Not available)	Depositor
$\langle I/\sigma(I) \rangle$ <sup>1</sup>	1.84 (at 2.02Å)	Xtrriage
Refinement program	PHENIX 1.14_3260	Depositor
R, $R_{free}$	0.214 , 0.255 0.220 , 0.257	Depositor DCC
$R_{free}$ test set	16283 reflections (5.04%)	wwPDB-VP
Wilson B-factor (Å <sup>2</sup> )	30.1	Xtrriage
Anisotropy	0.794	Xtrriage
Bulk solvent $k_{sol}$ (e/Å <sup>3</sup> ), $B_{sol}$ (Å <sup>2</sup> )	0.34 , 44.0	EDS
L-test for twinning <sup>2</sup>	$\langle  L  \rangle = 0.49$ , $\langle L^2 \rangle = 0.32$	Xtrriage
Estimated twinning fraction	0.058 for h,-k,-l	Xtrriage
$F_o, F_c$ correlation	0.95	EDS
Total number of atoms	36907	wwPDB-VP
Average B, all atoms (Å <sup>2</sup> )	51.0	wwPDB-VP

Xtrriage's analysis on translational NCS is as follows: *The analyses of the Patterson function reveals a significant off-origin peak that is 58.28 % of the origin peak, indicating pseudo-translational symmetry. The chance of finding a peak of this or larger height randomly in a structure without pseudo-translational symmetry is equal to 2.0924e-05. The detected translational NCS is most likely also responsible for the elevated intensity ratio.*

<sup>1</sup>Intensities estimated from amplitudes.

<sup>2</sup>Theoretical values of  $\langle |L| \rangle$ ,  $\langle L^2 \rangle$  for acentric reflections are 0.5, 0.333 respectively for untwinned datasets, and 0.375, 0.2 for perfectly twinned datasets.

## 5 Model quality

### 5.1 Standard geometry

Bond lengths and bond angles in the following residue types are not validated in this section: QKQ, EPE, FE, FES

The Z score for a bond length (or angle) is the number of standard deviations the observed value is removed from the expected value. A bond length (or angle) with  $|Z| > 5$  is considered an outlier worth inspection. RMSZ is the root-mean-square of all Z scores of the bond lengths (or angles).

Mol	Chain	Bond lengths		Bond angles	
		RMSZ	# Z  >5	RMSZ	# Z  >5
1	A	0.46	0/3003	0.60	0/4080
1	B	0.45	0/2981	0.61	0/4048
1	C	0.43	0/2983	0.61	0/4052
1	D	0.46	0/3003	0.62	0/4080
1	E	0.44	0/3003	0.60	0/4080
1	F	0.47	0/2997	0.62	0/4072
1	G	0.47	0/3032	0.61	0/4117
1	H	0.48	0/2990	0.62	0/4062
1	I	0.50	0/2989	0.63	0/4060
1	J	0.47	0/2973	0.61	0/4040
1	K	0.44	0/2996	0.61	1/4070 (0.0%)
1	L	0.45	0/2990	0.60	0/4062
All	All	0.46	0/35940	0.61	1/48823 (0.0%)

There are no bond length outliers.

All (1) bond angle outliers are listed below:

Mol	Chain	Res	Type	Atoms	Z	Observed(°)	Ideal(°)
1	K	236	GLN	CB-CA-C	5.83	122.06	110.40

There are no chirality outliers.

There are no planarity outliers.

### 5.2 Too-close contacts

In the following table, the Non-H and H(model) columns list the number of non-hydrogen atoms and hydrogen atoms in the chain respectively. The H(added) column lists the number of hydrogen atoms added and optimized by MolProbity. The Clashes column lists the number of clashes within the asymmetric unit, whereas Symm-Clashes lists symmetry related clashes.

Mol	Chain	Non-H	H(model)	H(added)	Clashes	Symm-Clashes
1	A	2917	0	2759	74	0
1	B	2895	0	2740	91	0
1	C	2897	0	2738	79	0
1	D	2917	0	2759	64	0
1	E	2917	0	2759	89	0
1	F	2911	0	2754	76	0
1	G	2945	0	2783	68	0
1	H	2904	0	2745	52	0
1	I	2903	0	2743	62	0
1	J	2887	0	2727	64	0
1	K	2910	0	2750	98	0
1	L	2904	0	2745	75	0
2	A	1	0	0	0	0
2	B	1	0	0	0	0
2	C	1	0	0	0	0
2	D	1	0	0	0	0
2	E	1	0	0	0	0
2	F	1	0	0	0	0
2	G	1	0	0	0	0
2	H	1	0	0	0	0
2	I	1	0	0	0	0
2	J	1	0	0	0	0
2	K	1	0	0	0	0
2	L	1	0	0	0	0
3	A	4	0	0	1	0
3	B	4	0	0	0	0
3	C	4	0	0	0	0
3	D	4	0	0	0	0
3	E	4	0	0	0	0
3	F	4	0	0	0	0
3	G	4	0	0	0	0
3	H	4	0	0	0	0
3	I	4	0	0	0	0
3	J	4	0	0	0	0
3	K	4	0	0	0	0
3	L	4	0	0	2	0
4	A	29	0	0	15	0
4	B	29	0	0	13	0
4	C	29	0	0	6	0
4	D	29	0	0	6	0
4	E	29	0	0	7	0
4	F	29	0	0	8	0
4	G	29	0	0	6	0

*Continued on next page...*

*Continued from previous page...*

Mol	Chain	Non-H	H(model)	H(added)	Clashes	Symm-Clashes
4	H	29	0	0	3	0
4	I	29	0	0	2	0
4	J	29	0	0	3	0
4	K	29	0	0	16	0
4	L	29	0	0	5	0
5	A	15	17	18	0	0
5	B	15	17	18	1	0
5	C	15	17	17	0	0
5	D	15	17	18	0	0
5	E	15	17	17	1	0
5	F	15	17	17	2	0
5	G	15	17	18	1	0
5	H	15	17	18	0	0
5	I	15	17	18	1	0
5	J	15	17	18	0	0
5	K	15	17	17	0	0
5	L	15	17	18	2	0
6	A	75	0	0	3	0
6	B	87	0	0	3	0
6	C	51	0	0	4	0
6	D	99	0	0	2	0
6	E	103	0	0	3	0
6	F	122	0	0	7	0
6	G	147	0	0	6	0
6	H	135	0	0	6	0
6	I	113	0	0	1	0
6	J	105	0	0	0	0
6	K	79	0	0	4	0
6	L	92	0	0	0	0
All	All	36703	204	33214	851	0

The all-atom clashscore is defined as the number of clashes found per 1000 atoms (including hydrogen atoms). The all-atom clashscore for this structure is 12.

All (851) close contacts within the same asymmetric unit are listed below, sorted by their clash magnitude.

Atom-1	Atom-2	Interatomic distance (Å)	Clash overlap (Å)
1:A:315:TYR:HE1	4:A:403:QKQ:C1	1.44	1.28
1:A:315:TYR:CE1	4:A:403:QKQ:C1	2.21	1.21
1:A:216:PHE:CZ	4:A:403:QKQ:C16	2.34	1.10
1:L:6:LYS:HE2	1:L:371:GLN:OXT	1.51	1.09

*Continued on next page...*



*Continued from previous page...*

Atom-1	Atom-2	Interatomic distance (Å)	Clash overlap (Å)
1:J:109:HIS:CD2	1:K:208:HIS:HB3	1.97	0.99
1:C:134:GLU:O	1:C:135:ASN:HB2	1.61	0.98
1:K:240:ALA:HB3	1:K:256:PRO:HG2	1.43	0.98
1:K:183:LYS:HD3	1:K:302:GLU:HG3	1.43	0.98
1:K:258:PHE:CD1	4:K:403:QKQ:C17	2.53	0.91
1:K:315:TYR:CE1	4:K:403:QKQ:C1	2.53	0.91
1:A:193:PRO:HG2	1:A:328:GLU:HG2	1.50	0.91
1:K:119:LEU:HD23	1:K:133:LYS:HG3	1.51	0.89
1:D:109:HIS:CD2	1:E:208:HIS:HB3	2.08	0.89
1:K:218:ASP:O	1:K:241:ARG:HB2	1.75	0.87
1:A:237:TYR:HE1	1:A:257:GLU:HB2	1.38	0.87
1:A:311:LEU:HG	1:A:315:TYR:HE2	1.37	0.87
1:C:5:GLU:HG2	1:C:24:VAL:HG11	1.56	0.86
1:D:208:HIS:HB3	1:F:109:HIS:CD2	2.10	0.86
1:G:208:HIS:HB3	1:I:109:HIS:CD2	2.10	0.86
1:K:315:TYR:OH	4:K:403:QKQ:C1	2.24	0.85
1:K:260:GLY:HA3	4:K:403:QKQ:C14	2.06	0.85
1:E:254:THR:HG22	1:E:255:ASP:H	1.40	0.85
1:E:221:GLN:NE2	1:E:241:ARG:HG3	1.92	0.85
1:H:119:LEU:HD23	1:H:133:LYS:HG3	1.59	0.84
1:E:119:LEU:HD23	1:E:133:LYS:HG3	1.58	0.84
1:C:69:ILE:HD13	1:C:141:LEU:HD11	1.59	0.84
1:F:340:ARG:HG3	1:F:340:ARG:HH11	1.41	0.83
1:G:224:LYS:HE2	1:G:239:PHE:HB2	1.59	0.83
1:I:306:GLN:HA	1:I:306:GLN:NE2	1.90	0.83
1:L:213:HIS:HB3	1:L:216:PHE:HB3	1.59	0.82
1:I:221:GLN:HB3	1:I:224:LYS:HB2	1.62	0.82
1:B:221:GLN:NE2	1:B:241:ARG:HB2	1.95	0.82
1:E:221:GLN:HE22	1:E:241:ARG:CB	1.92	0.82
1:J:349:LYS:HE3	1:L:129:GLU:HB2	1.62	0.82
1:H:166:PRO:HB2	1:H:231:GLN:HG3	1.60	0.81
1:B:213:HIS:HB3	1:B:216:PHE:HB3	1.59	0.81
1:K:315:TYR:HE1	4:K:403:QKQ:C1	1.92	0.81
1:C:180:LYS:H	1:C:180:LYS:HE2	1.42	0.81
1:D:315:TYR:OH	4:D:403:QKQ:C1	2.29	0.80
1:K:183:LYS:HD3	1:K:302:GLU:CG	2.12	0.80
1:B:216:PHE:CZ	4:B:403:QKQ:C17	2.65	0.80
1:F:166:PRO:HB2	1:F:231:GLN:HG3	1.62	0.79
1:F:315:TYR:OH	4:F:403:QKQ:C1	2.31	0.79
1:A:216:PHE:HZ	4:A:403:QKQ:C16	1.94	0.79
1:F:119:LEU:HD23	1:F:133:LYS:HG3	1.65	0.79

*Continued on next page...*

*Continued from previous page...*

Atom-1	Atom-2	Interatomic distance (Å)	Clash overlap (Å)
1:K:183:LYS:CD	1:K:302:GLU:HG3	2.11	0.79
1:I:113:PHE:HB2	1:I:138:MET:HE3	1.65	0.78
1:L:340:ARG:HB3	5:L:404:EPE:O2S	1.82	0.78
1:F:213:HIS:HB3	1:F:216:PHE:HB3	1.64	0.78
1:K:109:HIS:CD2	1:L:208:HIS:HB3	2.20	0.77
1:C:134:GLU:O	1:C:135:ASN:CB	2.31	0.77
1:I:223:ASP:N	1:I:223:ASP:OD1	2.17	0.77
1:J:313:GLU:OE2	1:J:316:ARG:HD2	1.85	0.77
1:B:104:ILE:HD13	1:B:138:MET:HE1	1.67	0.76
1:E:113:PHE:HB2	1:E:138:MET:HE3	1.66	0.76
1:L:6:LYS:HD2	1:L:371:GLN:C	2.06	0.76
1:L:220:VAL:CG1	1:L:225:TYR:HE1	1.98	0.76
1:C:193:PRO:HG2	1:C:328:GLU:HG2	1.68	0.75
1:J:272:PRO:HG2	1:J:277:PHE:CZ	2.20	0.75
1:H:109:HIS:CD2	1:I:208:HIS:HB3	2.22	0.75
1:E:305:THR:HG22	1:E:308:GLN:HG3	1.68	0.74
1:G:193:PRO:HG2	1:G:328:GLU:HG2	1.70	0.74
1:K:146:TYR:CB	1:K:161:VAL:HG11	2.18	0.73
1:E:315:TYR:OH	4:E:403:QKQ:C1	2.37	0.73
1:L:6:LYS:CE	1:L:371:GLN:OXT	2.34	0.73
1:D:122:ALA:O	1:D:125:CYS:HB2	1.88	0.73
1:L:272:PRO:HG2	1:L:277:PHE:CZ	2.25	0.72
1:K:236:GLN:NE2	4:K:403:QKQ:O2	2.22	0.72
1:D:217:ALA:O	1:D:220:VAL:HG12	1.89	0.72
1:E:272:PRO:HG2	1:E:277:PHE:CZ	2.24	0.72
1:K:146:TYR:HB2	1:K:161:VAL:HG11	1.71	0.72
1:G:323:ASP:OD2	4:G:403:QKQ:N1	2.23	0.71
1:C:71:ILE:HD11	1:C:152:ILE:HG21	1.73	0.71
1:F:134:GLU:O	1:F:135:ASN:HB2	1.89	0.71
1:A:347:THR:HG23	1:A:357:HIS:HB3	1.71	0.71
1:B:216:PHE:CE1	4:B:403:QKQ:C17	2.73	0.71
1:K:258:PHE:CG	4:K:403:QKQ:C17	2.72	0.71
1:A:128:VAL:HG11	1:B:346:MET:HE1	1.71	0.71
1:J:221:GLN:HG2	1:J:224:LYS:HB2	1.73	0.71
1:L:9:GLU:OE2	1:L:371:GLN:NE2	2.23	0.71
1:A:236:GLN:CD	4:A:403:QKQ:O2	2.29	0.71
1:K:315:TYR:CZ	4:K:403:QKQ:C1	2.73	0.71
1:G:183:LYS:NZ	6:G:503:HOH:O	2.24	0.70
1:C:6:LYS:HE2	1:C:371:GLN:OXT	1.90	0.70
1:B:104:ILE:HD13	1:B:138:MET:CE	2.22	0.70
1:A:237:TYR:CE1	1:A:257:GLU:HB2	2.25	0.70

*Continued on next page...*

*Continued from previous page...*

Atom-1	Atom-2	Interatomic distance (Å)	Clash overlap (Å)
1:E:305:THR:HG23	1:E:308:GLN:H	1.55	0.70
1:K:258:PHE:HB2	4:K:403:QKQ:C18	2.21	0.70
1:F:258:PHE:HB3	1:F:273:PRO:HD3	1.74	0.70
1:J:206:CYS:SG	4:J:403:QKQ:C11	2.80	0.70
1:J:109:HIS:NE2	1:K:208:HIS:HB3	2.06	0.69
1:L:315:TYR:OH	4:L:403:QKQ:C1	2.40	0.69
1:C:55:GLN:OE1	1:C:55:GLN:HA	1.92	0.69
1:E:221:GLN:NE2	1:E:241:ARG:CG	2.55	0.69
1:I:213:HIS:HB3	1:I:216:PHE:HB3	1.73	0.69
1:B:216:PHE:HZ	4:B:403:QKQ:C17	2.06	0.69
1:C:5:GLU:O	1:C:6:LYS:HG2	1.92	0.69
1:J:208:HIS:HB3	1:L:109:HIS:CD2	2.28	0.69
1:F:30:GLN:OE1	1:F:30:GLN:HA	1.92	0.69
1:H:213:HIS:HB3	1:H:216:PHE:HB3	1.73	0.69
1:J:228:THR:HG22	1:J:230:HIS:NE2	2.07	0.69
1:G:109:HIS:CD2	1:H:208:HIS:HB3	2.28	0.69
1:F:347:THR:HG23	1:F:357:HIS:HB3	1.75	0.69
1:J:86:CYS:SG	1:J:87:PRO:HD2	2.33	0.68
1:A:311:LEU:HG	1:A:315:TYR:CE2	2.25	0.68
1:K:218:ASP:O	1:K:241:ARG:CB	2.42	0.68
1:F:216:PHE:HZ	4:F:403:QKQ:C16	2.07	0.68
1:H:36:LYS:NZ	6:H:502:HOH:O	2.26	0.68
1:B:166:PRO:HB2	1:B:231:GLN:HG3	1.75	0.68
1:L:221:GLN:HE21	1:L:241:ARG:HB2	1.59	0.68
1:C:5:GLU:HG2	1:C:24:VAL:CG1	2.24	0.67
1:E:113:PHE:CG	1:E:138:MET:HE2	2.30	0.67
1:B:272:PRO:HB3	4:B:403:QKQ:N4	2.09	0.67
1:A:146:TYR:CZ	1:A:169:ALA:HB2	2.29	0.67
1:A:109:HIS:CD2	1:B:208:HIS:HB3	2.30	0.67
1:D:17:VAL:O	1:D:17:VAL:HG23	1.95	0.66
1:K:227:HIS:NE2	1:K:358:GLY:HA3	2.11	0.66
1:E:47:VAL:HB	1:E:62:ARG:HG3	1.77	0.66
1:L:86:CYS:SG	1:L:87:PRO:HD2	2.36	0.66
1:A:171:ARG:HD2	1:A:174:GLN:OE1	1.96	0.66
1:A:311:LEU:O	1:A:315:TYR:HD2	1.78	0.66
1:B:304:LEU:N	1:B:304:LEU:HD22	2.10	0.66
1:H:193:PRO:HG2	1:H:328:GLU:HG2	1.77	0.66
1:B:221:GLN:HE22	1:B:241:ARG:HB2	1.60	0.66
1:A:315:TYR:CZ	4:A:403:QKQ:C1	2.77	0.65
1:C:180:LYS:NZ	6:C:502:HOH:O	2.28	0.65
1:I:122:ALA:HB3	1:I:125:CYS:HB2	1.78	0.65

*Continued on next page...*

*Continued from previous page...*

Atom-1	Atom-2	Interatomic distance (Å)	Clash overlap (Å)
1:J:346:MET:HE1	1:L:128:VAL:HG11	1.78	0.65
1:H:272:PRO:HG2	1:H:277:PHE:CZ	2.32	0.65
1:I:272:PRO:HG2	1:I:277:PHE:CZ	2.31	0.65
1:K:17:VAL:HG13	1:K:17:VAL:O	1.97	0.65
1:L:220:VAL:CG1	1:L:225:TYR:CE1	2.79	0.65
1:D:347:THR:HG23	1:D:357:HIS:HB3	1.78	0.64
1:E:17:VAL:O	1:E:17:VAL:HG23	1.97	0.64
1:E:46:CYS:HB2	1:E:151:PHE:CE2	2.31	0.64
1:C:347:THR:HG23	1:C:357:HIS:HB3	1.78	0.64
1:G:347:THR:HG23	1:G:357:HIS:HB3	1.80	0.64
1:G:281:ILE:HG12	1:G:295:TYR:CD1	2.33	0.64
1:E:221:GLN:HE22	1:E:241:ARG:HB2	1.62	0.64
1:E:166:PRO:HB2	1:E:231:GLN:HG3	1.80	0.64
1:D:193:PRO:HG2	1:D:328:GLU:HG2	1.80	0.64
1:L:134:GLU:O	1:L:135:ASN:HB2	1.98	0.63
1:B:76:ASP:OD1	1:B:76:ASP:N	2.30	0.63
1:E:221:GLN:NE2	1:E:241:ARG:CB	2.61	0.63
1:B:193:PRO:HG2	1:B:328:GLU:HG2	1.80	0.63
1:E:347:THR:HG23	1:E:357:HIS:HB3	1.80	0.63
1:C:206:CYS:SG	1:C:225:TYR:OH	2.52	0.63
1:G:202:ASN:ND2	1:G:323:ASP:OD1	2.24	0.63
1:K:47:VAL:HG21	1:K:71:ILE:CD1	2.29	0.63
1:E:305:THR:CG2	1:E:308:GLN:HG3	2.28	0.63
1:J:109:HIS:CD2	1:K:208:HIS:CB	2.78	0.63
1:F:340:ARG:HG3	1:F:340:ARG:NH1	2.10	0.62
1:B:230:HIS:HB3	1:B:231:GLN:NE2	2.14	0.62
1:D:205:GLU:HG2	1:D:359:ILE:HD11	1.81	0.62
1:G:70:VAL:HG12	1:G:82:PHE:O	1.99	0.62
1:K:205:GLU:CD	1:K:208:HIS:HD1	2.00	0.62
1:K:193:PRO:HG2	1:K:328:GLU:HG2	1.80	0.62
1:L:206:CYS:HG	1:L:225:TYR:HH	1.46	0.62
1:B:334:LEU:HD12	1:B:334:LEU:C	2.20	0.62
1:B:258:PHE:CD1	4:B:403:QKQ:C16	2.82	0.62
1:E:113:PHE:CD1	1:E:138:MET:HE2	2.35	0.62
1:K:202:ASN:O	1:K:208:HIS:HE1	1.83	0.62
1:A:216:PHE:HZ	4:A:403:QKQ:C15	2.13	0.62
1:D:37:GLU:O	1:D:42:LYS:HG3	2.00	0.62
1:F:193:PRO:HG2	1:F:328:GLU:HG2	1.80	0.62
1:G:75:LYS:HE2	1:G:102:ASN:CG	2.20	0.62
1:J:193:PRO:HG2	1:J:328:GLU:HG2	1.81	0.62
1:A:173:ASN:OD1	1:A:179:ILE:HD12	2.00	0.61

*Continued on next page...*

*Continued from previous page...*

Atom-1	Atom-2	Interatomic distance (Å)	Clash overlap (Å)
1:C:313:GLU:OE2	1:C:317:ASN:ND2	2.32	0.61
1:I:306:GLN:HA	1:I:306:GLN:HE21	1.60	0.61
1:E:206:CYS:HG	1:E:225:TYR:HH	1.48	0.61
1:E:305:THR:HG22	1:E:308:GLN:CG	2.30	0.61
1:D:213:HIS:HB3	1:D:216:PHE:HB3	1.80	0.61
1:E:206:CYS:SG	1:E:225:TYR:OH	2.55	0.61
1:A:227:HIS:CG	1:A:236:GLN:HG2	2.36	0.61
1:B:216:PHE:O	1:B:220:VAL:HG23	2.00	0.61
1:E:254:THR:HG22	1:E:255:ASP:N	2.15	0.61
1:L:221:GLN:NE2	1:L:241:ARG:HB2	2.15	0.61
1:A:260:GLY:HA3	4:A:403:QKQ:N2	2.15	0.61
1:E:128:VAL:HG11	1:F:346:MET:HE1	1.81	0.61
1:G:220:VAL:HG13	1:G:225:TYR:CD2	2.35	0.61
1:B:128:VAL:HG11	1:C:346:MET:HE1	1.83	0.61
1:D:306:GLN:OE1	1:D:309:LYS:HE3	2.01	0.61
1:D:109:HIS:NE2	1:E:208:HIS:HB3	2.15	0.60
1:E:193:PRO:HG2	1:E:328:GLU:HG2	1.82	0.60
1:F:344:ARG:CG	1:F:346:MET:HE3	2.31	0.60
1:L:55:GLN:HA	1:L:55:GLN:OE1	2.00	0.60
1:D:224:LYS:HD3	1:D:226:TRP:HH2	1.66	0.60
1:C:72:ILE:HD11	1:C:115:LEU:HD22	1.83	0.60
1:I:6:LYS:HE3	1:I:371:GLN:C	2.21	0.60
1:E:109:HIS:CD2	1:F:208:HIS:HB3	2.36	0.60
1:K:14:ASN:ND2	1:K:17:VAL:HG12	2.17	0.60
1:K:258:PHE:CB	4:K:403:QKQ:C18	2.80	0.60
1:C:350:GLN:OE1	1:C:350:GLN:N	2.27	0.60
1:E:260:GLY:HA3	4:E:403:QKQ:C14	2.32	0.60
1:L:166:PRO:HB2	1:L:231:GLN:HG3	1.82	0.60
1:C:219:SER:O	1:C:241:ARG:N	2.35	0.59
1:H:63:LYS:HE3	6:H:553:HOH:O	2.01	0.59
1:E:221:GLN:HE21	1:E:241:ARG:HE	1.50	0.59
1:F:219:SER:HB2	4:F:403:QKQ:C18	2.31	0.59
1:K:166:PRO:HD2	1:K:231:GLN:HG2	1.85	0.59
1:F:219:SER:CB	4:F:403:QKQ:C18	2.80	0.59
1:C:315:TYR:OH	4:C:403:QKQ:C1	2.51	0.59
1:G:119:LEU:HD23	1:G:133:LYS:HG3	1.84	0.59
1:B:216:PHE:HE1	4:B:403:QKQ:C18	2.16	0.59
1:C:350:GLN:CD	1:C:350:GLN:H	2.04	0.59
1:J:128:VAL:HG11	1:K:346:MET:HE1	1.84	0.59
1:G:213:HIS:HB3	1:G:216:PHE:HB3	1.84	0.59
1:B:260:GLY:HA3	4:B:403:QKQ:C14	2.32	0.58

*Continued on next page...*

*Continued from previous page...*

Atom-1	Atom-2	Interatomic distance (Å)	Clash overlap (Å)
1:C:113:PHE:HB2	1:C:138:MET:HE3	1.85	0.58
1:G:272:PRO:HG2	1:G:277:PHE:CE2	2.38	0.58
1:K:216:PHE:CD1	1:K:219:SER:HB2	2.39	0.58
1:K:46:CYS:HB2	1:K:151:PHE:CE2	2.38	0.58
1:C:32:PHE:CE2	1:C:287:ASP:HA	2.38	0.58
1:D:46:CYS:HB2	1:D:151:PHE:CE2	2.39	0.58
1:J:10:ASP:OD1	1:J:10:ASP:N	2.36	0.58
1:E:86:CYS:SG	1:E:87:PRO:HD2	2.43	0.58
1:K:272:PRO:HG2	1:K:277:PHE:CZ	2.39	0.58
1:D:340:ARG:NH2	1:F:137:SER:O	2.37	0.58
1:E:146:TYR:CZ	1:E:169:ALA:HB2	2.38	0.58
1:L:220:VAL:HG13	1:L:225:TYR:HE1	1.68	0.58
1:C:26:TYR:CD1	1:C:198:VAL:HG23	2.38	0.58
1:I:26:TYR:CD1	1:I:198:VAL:HG23	2.38	0.58
1:B:125:CYS:HB2	1:B:131:PHE:CD2	2.39	0.58
1:C:69:ILE:HD13	1:C:141:LEU:CD1	2.31	0.58
1:G:281:ILE:HG12	1:G:295:TYR:HD1	1.69	0.58
1:G:206:CYS:SG	1:G:225:TYR:OH	2.57	0.58
1:H:17:VAL:O	1:H:17:VAL:HG23	2.04	0.58
1:J:188:PHE:CZ	1:J:316:ARG:HB2	2.39	0.58
1:L:238:GLY:HA3	1:L:258:PHE:CZ	2.38	0.58
1:A:311:LEU:O	1:A:315:TYR:CD2	2.57	0.57
1:E:272:PRO:HG2	1:E:277:PHE:CE2	2.39	0.57
1:I:86:CYS:SG	1:I:87:PRO:HD2	2.44	0.57
1:F:30:GLN:NE2	6:F:502:HOH:O	2.36	0.57
1:A:122:ALA:HB3	1:A:125:CYS:HB2	1.86	0.57
1:G:224:LYS:HE2	1:G:239:PHE:CB	2.31	0.57
1:C:6:LYS:HB3	1:C:370:HIS:O	2.04	0.57
1:K:47:VAL:HG21	1:K:71:ILE:HD13	1.85	0.57
1:B:318:VAL:O	1:B:322:GLU:HG3	2.04	0.57
1:G:295:TYR:OH	4:G:403:QKQ:C3	2.52	0.57
1:K:122:ALA:O	1:K:125:CYS:HB2	2.04	0.57
1:L:254:THR:O	1:L:256:PRO:HD3	2.04	0.57
1:A:272:PRO:HA	4:A:403:QKQ:N4	2.19	0.57
1:C:42:LYS:HA	1:C:155:ASP:HB2	1.86	0.57
1:F:216:PHE:CZ	4:F:403:QKQ:C16	2.87	0.57
1:B:304:LEU:HD22	1:B:304:LEU:H	1.70	0.56
1:D:371:GLN:N	1:D:371:GLN:NE2	2.52	0.56
1:A:359:ILE:O	1:A:363:GLN:HG3	2.05	0.56
1:B:75:LYS:HD2	1:B:102:ASN:OD1	2.05	0.56
1:A:205:GLU:HG2	1:A:359:ILE:HD11	1.87	0.56

*Continued on next page...*

*Continued from previous page...*

Atom-1	Atom-2	Interatomic distance (Å)	Clash overlap (Å)
1:J:344:ARG:CG	1:J:346:MET:HE3	2.35	0.56
1:B:212:ALA:HB1	1:B:326:LEU:HD11	1.86	0.56
1:B:86:CYS:HB2	1:B:93:LEU:HD21	1.86	0.56
1:D:214:PRO:HD2	1:D:322:GLU:OE2	2.06	0.56
1:A:207:TYR:CE2	1:A:346:MET:HG3	2.40	0.56
1:C:142:LYS:NZ	1:C:156:GLU:O	2.36	0.56
1:F:188:PHE:CZ	1:F:316:ARG:HB2	2.41	0.56
4:A:403:QKQ:C19	4:A:403:QKQ:C14	2.84	0.56
1:A:216:PHE:CE1	4:A:403:QKQ:C17	2.88	0.56
1:C:202:ASN:ND2	1:C:323:ASP:OD1	2.28	0.56
1:J:368:GLN:O	1:J:371:GLN:OE1	2.23	0.56
1:K:179:ILE:HA	1:K:182:LEU:HD12	1.87	0.56
1:K:144:GLU:OE1	1:K:161:VAL:HG12	2.06	0.55
1:K:347:THR:HG23	1:K:357:HIS:HB3	1.88	0.55
1:D:225:TYR:OH	4:D:403:QKQ:O2	2.23	0.55
1:E:221:GLN:HE22	1:E:241:ARG:CA	2.18	0.55
1:E:236:GLN:OE1	4:E:403:QKQ:O2	2.23	0.55
1:I:213:HIS:CB	1:I:216:PHE:HB3	2.37	0.55
1:L:206:CYS:SG	1:L:225:TYR:OH	2.57	0.55
1:E:237:TYR:HD1	1:E:238:GLY:N	2.05	0.55
1:C:46:CYS:HB2	1:C:151:PHE:CE2	2.42	0.55
1:K:8:PRO:HG2	1:K:11:PHE:HB2	1.88	0.55
1:E:340:ARG:HB3	5:E:404:EPE:O2S	2.06	0.55
1:F:344:ARG:HG2	1:F:346:MET:HE3	1.88	0.55
1:A:347:THR:CG2	1:A:357:HIS:HB3	2.37	0.55
1:C:134:GLU:HG2	1:C:137:SER:HB2	1.89	0.55
1:A:253:VAL:CG2	1:A:256:PRO:HG3	2.37	0.55
1:J:281:ILE:HG12	1:J:295:TYR:CD1	2.41	0.55
1:D:344:ARG:HG3	1:D:346:MET:HE2	1.89	0.54
4:D:403:QKQ:C19	4:D:403:QKQ:C22	2.86	0.54
1:E:113:PHE:HB2	1:E:138:MET:CE	2.37	0.54
4:D:403:QKQ:C19	4:D:403:QKQ:C1	2.86	0.54
1:G:208:HIS:HB3	1:I:109:HIS:NE2	2.22	0.54
1:A:208:HIS:HB3	1:C:109:HIS:CD2	2.42	0.54
1:E:221:GLN:NE2	1:E:241:ARG:HB2	2.21	0.54
1:I:6:LYS:HE3	1:I:371:GLN:OXT	2.08	0.54
1:K:348:ASP:HB2	1:K:350:GLN:OE1	2.08	0.54
1:L:344:ARG:CG	1:L:346:MET:CE	2.86	0.54
1:H:206:CYS:SG	4:H:403:QKQ:C11	2.96	0.54
1:J:346:MET:HA	1:J:346:MET:HE2	1.88	0.54
4:L:403:QKQ:C19	4:L:403:QKQ:C22	2.85	0.54

*Continued on next page...*

*Continued from previous page...*

Atom-1	Atom-2	Interatomic distance (Å)	Clash overlap (Å)
1:D:350:GLN:CD	1:D:350:GLN:H	2.11	0.54
1:D:42:LYS:HD2	6:D:573:HOH:O	2.08	0.54
1:E:212:ALA:HB1	1:E:326:LEU:HD11	1.90	0.54
1:C:238:GLY:HA3	1:C:258:PHE:CE2	2.43	0.53
1:C:272:PRO:HG2	1:C:277:PHE:CZ	2.43	0.53
1:E:119:LEU:HD22	1:E:136:SER:HB2	1.89	0.53
1:E:313:GLU:HG3	1:E:317:ASN:ND2	2.22	0.53
1:E:334:LEU:C	1:E:334:LEU:HD12	2.29	0.53
1:I:193:PRO:HG2	1:I:328:GLU:HG2	1.88	0.53
1:L:344:ARG:HG3	1:L:346:MET:HE2	1.90	0.53
1:E:259:HIS:HB2	1:E:271:VAL:HB	1.90	0.53
1:C:213:HIS:ND1	1:C:322:GLU:OE2	2.35	0.53
1:H:347:THR:HG23	1:H:357:HIS:HB3	1.91	0.53
1:K:344:ARG:CG	1:K:346:MET:HE3	2.39	0.53
1:C:24:VAL:HG22	1:C:28:SER:HB2	1.89	0.53
1:J:301:ASN:ND2	1:J:303:GLU:O	2.38	0.53
1:B:216:PHE:HE1	4:B:403:QKQ:C17	2.22	0.53
1:F:344:ARG:HG3	1:F:346:MET:CE	2.39	0.53
1:I:46:CYS:HB2	1:I:151:PHE:CE2	2.43	0.53
1:I:47:VAL:HB	1:I:62:ARG:HG3	1.90	0.53
1:A:188:PHE:HB2	1:A:295:TYR:HB3	1.91	0.53
1:D:14:ASN:ND2	1:D:17:VAL:HG22	2.23	0.53
1:E:14:ASN:ND2	1:E:17:VAL:HG22	2.24	0.53
1:C:180:LYS:H	1:C:180:LYS:CE	2.16	0.53
1:K:344:ARG:HG3	1:K:346:MET:CE	2.39	0.53
1:D:27:THR:HG21	1:D:335:LYS:HG2	1.90	0.52
1:E:205:GLU:CD	1:E:208:HIS:HD1	2.12	0.52
1:E:6:LYS:HD3	1:E:371:GLN:C	2.29	0.52
1:A:271:VAL:HG12	1:A:275:SER:HA	1.92	0.52
1:C:146:TYR:CZ	1:C:169:ALA:HB2	2.44	0.52
4:I:403:QKQ:N5	4:I:403:QKQ:C21	2.69	0.52
1:E:236:GLN:CD	4:E:403:QKQ:O2	2.48	0.52
1:F:86:CYS:HB2	1:F:93:LEU:HD21	1.91	0.52
1:A:32:PHE:CE2	1:A:287:ASP:HA	2.44	0.52
1:E:188:PHE:CZ	1:E:316:ARG:HB2	2.44	0.52
1:F:101:LYS:NZ	6:F:510:HOH:O	2.42	0.52
1:L:47:VAL:HB	1:L:62:ARG:HG3	1.90	0.52
1:F:281:ILE:HG12	1:F:295:TYR:HD1	1.75	0.52
1:K:269:PHE:HB3	1:K:278:MET:CE	2.39	0.52
1:A:221:GLN:O	1:A:225:TYR:HB2	2.10	0.52
1:B:80:ARG:HD2	1:B:116:ASP:HA	1.92	0.52

*Continued on next page...*



*Continued from previous page...*

Atom-1	Atom-2	Interatomic distance (Å)	Clash overlap (Å)
1:D:272:PRO:HG2	1:D:277:PHE:CZ	2.44	0.52
1:H:258:PHE:CD1	4:H:403:QKQ:C15	2.92	0.52
4:L:403:QKQ:C21	4:L:403:QKQ:N5	2.72	0.52
1:A:193:PRO:CG	1:A:328:GLU:HG2	2.30	0.52
1:C:76:ASP:OD2	1:C:80:ARG:NH2	2.29	0.52
1:E:227:HIS:ND1	6:E:505:HOH:O	2.34	0.52
1:G:86:CYS:SG	1:G:87:PRO:HD2	2.50	0.52
1:H:170:GLU:HG3	6:H:561:HOH:O	2.09	0.52
1:F:219:SER:HB3	4:F:403:QKQ:C18	2.40	0.52
1:J:216:PHE:O	1:J:216:PHE:CG	2.62	0.52
1:L:212:ALA:HB1	1:L:326:LEU:HD11	1.91	0.52
1:L:27:THR:HG21	1:L:335:LYS:HG2	1.92	0.51
1:C:75:LYS:HD3	1:C:102:ASN:OD1	2.10	0.51
1:C:313:GLU:HA	1:C:313:GLU:OE1	2.11	0.51
1:I:213:HIS:HB3	1:I:216:PHE:CB	2.37	0.51
1:H:86:CYS:SG	1:H:87:PRO:HD2	2.50	0.51
1:D:208:HIS:HB3	1:F:109:HIS:HD2	1.69	0.51
1:E:115:LEU:HD23	1:E:115:LEU:N	2.25	0.51
1:E:132:ASP:CG	1:E:135:ASN:HB2	2.31	0.51
1:J:344:ARG:HG3	1:J:346:MET:CE	2.40	0.51
1:J:122:ALA:O	1:J:125:CYS:HB2	2.11	0.51
1:L:230:HIS:HB3	1:L:231:GLN:NE2	2.24	0.51
1:D:213:HIS:ND1	1:D:322:GLU:OE1	2.42	0.51
4:E:403:QKQ:C22	4:E:403:QKQ:C19	2.88	0.51
1:F:159:THR:OG1	1:F:160:CYS:N	2.43	0.51
1:F:344:ARG:CG	1:F:346:MET:CE	2.88	0.51
4:F:403:QKQ:N5	4:F:403:QKQ:C21	2.71	0.51
1:K:229:THR:OG1	1:K:361:TYR:CG	2.64	0.51
1:I:344:ARG:HG3	1:I:346:MET:HE2	1.93	0.51
1:A:227:HIS:ND1	6:A:504:HOH:O	2.34	0.51
1:A:8:PRO:HD2	1:A:11:PHE:HB2	1.92	0.51
4:B:403:QKQ:C21	4:B:403:QKQ:N5	2.73	0.51
1:E:286:VAL:HB	1:E:290:THR:HB	1.91	0.51
1:F:134:GLU:O	1:F:135:ASN:CB	2.59	0.51
4:K:403:QKQ:C19	4:K:403:QKQ:C22	2.88	0.51
1:D:224:LYS:HD2	1:D:239:PHE:CD2	2.45	0.51
1:I:113:PHE:CD1	1:I:138:MET:HE2	2.46	0.51
1:F:281:ILE:HG12	1:F:295:TYR:CD1	2.46	0.51
1:I:316:ARG:HG2	1:I:317:ASN:OD1	2.10	0.51
1:K:47:VAL:HB	1:K:62:ARG:HG3	1.91	0.51
1:D:334:LEU:C	1:D:334:LEU:HD12	2.31	0.50

*Continued on next page...*

*Continued from previous page...*

Atom-1	Atom-2	Interatomic distance (Å)	Clash overlap (Å)
1:D:5:GLU:O	1:D:6:LYS:HD2	2.10	0.50
1:D:208:HIS:CB	1:F:109:HIS:CD2	2.90	0.50
1:G:336:SER:CB	6:G:504:HOH:O	2.58	0.50
4:C:403:QKQ:C21	4:C:403:QKQ:N5	2.71	0.50
1:G:63:LYS:HE3	6:G:629:HOH:O	2.10	0.50
1:K:6:LYS:HD2	1:K:371:GLN:C	2.31	0.50
1:I:238:GLY:HA3	1:I:258:PHE:CZ	2.46	0.50
1:B:282:TYR:HB2	1:B:294:HIS:HB2	1.94	0.50
1:H:88:HIS:CE1	1:H:109:HIS:ND1	2.80	0.50
1:J:281:ILE:HG12	1:J:295:TYR:HD1	1.75	0.50
1:K:227:HIS:HE1	1:K:234:THR:CB	2.24	0.50
1:L:352:SER:OG	1:L:353:GLY:N	2.44	0.50
1:G:344:ARG:HG3	1:G:346:MET:HE2	1.94	0.50
1:G:340:ARG:HB3	5:G:404:EPE:O2S	2.12	0.50
1:J:213:HIS:HB3	1:J:216:PHE:HB3	1.94	0.50
1:A:253:VAL:O	1:A:253:VAL:HG22	2.11	0.50
1:B:89:ARG:NH1	1:B:109:HIS:CE1	2.79	0.50
1:B:304:LEU:CD2	1:B:304:LEU:H	2.25	0.50
1:D:224:LYS:HD2	1:D:239:PHE:HD2	1.76	0.50
1:D:340:ARG:O	1:D:342:GLN:N	2.45	0.50
1:D:47:VAL:HB	1:D:62:ARG:HG3	1.94	0.50
1:K:227:HIS:HD2	6:K:522:HOH:O	1.93	0.50
1:E:348:ASP:O	1:E:351:ARG:NH1	2.45	0.50
5:F:404:EPE:C8	6:F:513:HOH:O	2.58	0.50
1:D:34:HIS:NE2	1:D:369:TYR:O	2.41	0.49
1:L:261:PHE:O	1:L:268:MET:HA	2.12	0.49
1:A:212:ALA:HB1	1:A:326:LEU:HD11	1.94	0.49
1:D:274:GLY:N	6:D:501:HOH:O	2.22	0.49
1:L:188:PHE:CZ	1:L:316:ARG:HB2	2.47	0.49
1:B:272:PRO:HG2	1:B:277:PHE:CZ	2.48	0.49
1:G:47:VAL:HB	1:G:62:ARG:HG3	1.93	0.49
1:F:70:VAL:HG21	1:F:94:LEU:HD12	1.95	0.49
1:D:109:HIS:CD2	1:E:208:HIS:CB	2.90	0.49
1:G:260:GLY:HA3	4:G:403:QKQ:C14	2.42	0.49
1:L:213:HIS:CB	1:L:216:PHE:HB3	2.37	0.49
1:L:344:ARG:HG3	1:L:346:MET:CE	2.43	0.49
1:C:180:LYS:HE2	1:C:180:LYS:N	2.19	0.49
1:D:344:ARG:HG3	1:D:346:MET:CE	2.42	0.49
1:E:254:THR:CG2	1:E:255:ASP:H	2.18	0.49
1:F:6:LYS:HD3	1:F:371:GLN:O	2.11	0.49
1:G:344:ARG:CG	1:G:346:MET:CE	2.91	0.49

*Continued on next page...*

*Continued from previous page...*

Atom-1	Atom-2	Interatomic distance (Å)	Clash overlap (Å)
1:B:196:TRP:CE2	1:B:197:LYS:HG3	2.47	0.49
1:E:221:GLN:HE22	1:E:241:ARG:N	2.10	0.49
1:G:279:THR:HA	1:G:296:ASP:O	2.12	0.49
1:K:319:PHE:HZ	4:K:403:QKQ:C7	2.26	0.49
1:C:36:LYS:HE2	1:C:37:GLU:OE2	2.12	0.49
1:A:221:GLN:HB2	1:A:224:LYS:HB2	1.95	0.49
1:B:296:ASP:HB3	1:B:298:TYR:CE2	2.48	0.49
1:F:142:LYS:HG3	1:F:156:GLU:HA	1.95	0.49
1:J:334:LEU:HD23	1:J:339:TYR:CE2	2.48	0.49
1:C:47:VAL:HG21	1:C:71:ILE:HD13	1.95	0.48
1:G:338:GLY:HA3	1:I:83:TYR:CG	2.48	0.48
1:H:55:GLN:O	1:H:73:ARG:HG2	2.12	0.48
1:I:93:LEU:HD13	1:I:138:MET:CE	2.43	0.48
1:B:347:THR:HG23	1:B:357:HIS:HB3	1.94	0.48
1:F:272:PRO:HG2	1:F:277:PHE:CZ	2.48	0.48
1:F:311:LEU:HG	1:F:315:TYR:CE2	2.48	0.48
1:F:346:MET:HE2	1:F:346:MET:HA	1.95	0.48
1:J:239:PHE:HB3	1:J:255:ASP:OD1	2.13	0.48
1:L:75:LYS:CE	1:L:75:LYS:HA	2.43	0.48
1:B:258:PHE:HB3	1:B:273:PRO:HD3	1.94	0.48
1:B:350:GLN:HG3	1:B:352:SER:HB3	1.94	0.48
1:F:253:VAL:HG12	1:F:254:THR:H	1.77	0.48
1:G:221:GLN:HB2	1:G:224:LYS:HB2	1.95	0.48
1:G:368:GLN:HA	1:G:371:GLN:NE2	2.27	0.48
1:C:286:VAL:HB	1:C:290:THR:HB	1.95	0.48
1:E:287:ASP:OD2	6:E:501:HOH:O	2.20	0.48
1:G:336:SER:HB2	6:G:504:HOH:O	2.13	0.48
1:L:193:PRO:HG2	1:L:328:GLU:HG2	1.94	0.48
1:A:104:ILE:O	1:A:112:THR:HA	2.13	0.48
1:A:64:VAL:HG23	1:A:284:PHE:HB3	1.95	0.48
1:A:46:CYS:HB2	1:A:151:PHE:CE2	2.48	0.48
1:K:371:GLN:NE2	1:K:371:GLN:N	2.62	0.48
1:B:218:ASP:OD1	1:B:219:SER:N	2.46	0.48
1:F:35:GLU:O	1:F:39:ILE:HB	2.14	0.48
5:F:404:EPE:H81	6:F:513:HOH:O	2.14	0.48
1:I:31:VAL:O	1:I:35:GLU:HG3	2.13	0.48
1:L:206:CYS:SG	4:L:403:QKQ:C11	3.02	0.48
1:L:7:LEU:HG	1:L:25:PHE:CZ	2.48	0.48
1:E:199:ILE:HG22	1:E:283:GLU:OE2	2.14	0.48
1:H:26:TYR:CD1	1:H:198:VAL:HG23	2.49	0.48
1:B:189:VAL:HG13	1:B:292:LEU:HD11	1.95	0.47

*Continued on next page...*

*Continued from previous page...*

Atom-1	Atom-2	Interatomic distance (Å)	Clash overlap (Å)
1:E:326:LEU:O	1:E:330:VAL:HG23	2.14	0.47
1:E:272:PRO:HB3	4:E:403:QKQ:N4	2.29	0.47
1:F:334:LEU:HD12	1:F:334:LEU:C	2.35	0.47
1:G:272:PRO:HG2	1:G:277:PHE:CZ	2.49	0.47
1:A:370:HIS:ND1	6:A:505:HOH:O	2.35	0.47
1:H:212:ALA:HB1	1:H:326:LEU:HD11	1.95	0.47
1:H:348:ASP:OD1	1:H:350:GLN:HG2	2.14	0.47
1:K:344:ARG:CG	1:K:346:MET:CE	2.92	0.47
1:A:88:HIS:HB2	1:A:111:TRP:CH2	2.50	0.47
1:B:315:TYR:OH	4:B:403:QKQ:C1	2.61	0.47
1:C:196:TRP:N	6:C:507:HOH:O	2.42	0.47
1:I:352:SER:OG	1:I:353:GLY:N	2.45	0.47
1:K:319:PHE:CZ	4:K:403:QKQ:C7	2.97	0.47
1:C:87:PRO:HD2	1:C:113:PHE:CZ	2.49	0.47
1:E:295:TYR:OH	4:E:403:QKQ:C3	2.62	0.47
1:K:231:GLN:O	1:K:232:ASN:HB2	2.14	0.47
1:A:170:GLU:O	1:A:174:GLN:HG3	2.14	0.47
1:B:20:THR:O	1:B:342:GLN:HB3	2.14	0.47
1:B:23:LYS:NZ	1:B:336:SER:O	2.48	0.47
1:A:253:VAL:HG22	1:A:256:PRO:HG3	1.96	0.47
1:C:5:GLU:HB3	1:C:25:PHE:CZ	2.49	0.47
1:D:238:GLY:HA3	1:D:258:PHE:CZ	2.49	0.47
1:E:87:PRO:HB3	1:F:340:ARG:HH12	1.80	0.47
1:K:209:CYS:O	1:K:213:HIS:HB2	2.14	0.47
1:L:86:CYS:SG	1:L:87:PRO:CD	3.02	0.47
1:A:257:GLU:O	1:A:273:PRO:HA	2.14	0.47
1:B:216:PHE:CE1	4:B:403:QKQ:C18	2.96	0.47
1:D:7:LEU:HG	1:D:25:PHE:CZ	2.50	0.47
1:F:271:VAL:HG12	1:F:275:SER:HA	1.97	0.47
1:G:338:GLY:HA3	1:I:83:TYR:CB	2.45	0.47
1:K:227:HIS:CD2	1:K:358:GLY:HA3	2.49	0.47
1:B:346:MET:HA	1:B:346:MET:HE2	1.95	0.47
1:B:145:GLU:HG3	1:B:149:PHE:O	2.14	0.47
1:H:10:ASP:OD1	1:H:10:ASP:N	2.42	0.47
1:K:55:GLN:NE2	1:K:55:GLN:HA	2.30	0.47
1:L:9:GLU:CD	1:L:371:GLN:NE2	2.69	0.47
1:A:27:THR:HG21	1:A:335:LYS:HG2	1.97	0.47
1:B:344:ARG:CG	1:B:346:MET:HE3	2.44	0.47
1:B:58:ASP:OD1	1:B:99:LYS:HE2	2.15	0.47
1:F:286:VAL:HB	1:F:290:THR:HB	1.97	0.47
1:L:221:GLN:HE21	1:L:241:ARG:CB	2.25	0.47

*Continued on next page...*

*Continued from previous page...*

Atom-1	Atom-2	Interatomic distance (Å)	Clash overlap (Å)
1:B:93:LEU:HD13	1:B:138:MET:CE	2.45	0.46
1:C:47:VAL:HB	1:C:62:ARG:HG3	1.96	0.46
1:E:213:HIS:HB3	1:E:216:PHE:HB3	1.97	0.46
1:I:23:LYS:NZ	1:I:336:SER:O	2.48	0.46
1:J:225:TYR:C	1:J:225:TYR:CD1	2.89	0.46
1:A:236:GLN:OE1	4:A:403:QKQ:O2	2.33	0.46
1:H:344:ARG:CG	1:H:346:MET:CE	2.94	0.46
1:I:306:GLN:CA	1:I:306:GLN:NE2	2.72	0.46
1:L:281:ILE:HG12	1:L:295:TYR:CD1	2.50	0.46
1:A:282:TYR:HB2	1:A:294:HIS:HB2	1.97	0.46
1:B:304:LEU:N	1:B:304:LEU:CD2	2.77	0.46
1:E:44:TRP:CE3	1:E:153:ASN:HB2	2.51	0.46
1:J:344:ARG:CG	1:J:346:MET:CE	2.93	0.46
1:B:75:LYS:HB3	1:B:75:LYS:NZ	2.29	0.46
1:C:238:GLY:HA3	1:C:258:PHE:CZ	2.50	0.46
1:H:346:MET:O	6:H:501:HOH:O	2.20	0.46
1:J:228:THR:CG2	1:J:230:HIS:NE2	2.76	0.46
1:J:238:GLY:HA3	1:J:258:PHE:CZ	2.50	0.46
1:E:104:ILE:HG21	1:E:138:MET:HE1	1.97	0.46
1:I:334:LEU:HD12	1:I:334:LEU:C	2.36	0.46
1:K:110:ALA:HB3	1:K:123:ARG:HD3	1.97	0.46
1:K:344:ARG:HG2	1:K:346:MET:HE3	1.98	0.46
1:K:258:PHE:CG	4:K:403:QKQ:C18	2.99	0.46
1:A:86:CYS:HB2	1:A:93:LEU:HD21	1.97	0.46
1:B:296:ASP:OD2	1:B:298:TYR:OH	2.26	0.46
1:F:180:LYS:HG2	6:F:575:HOH:O	2.16	0.46
1:F:273:PRO:HD2	4:F:403:QKQ:C19	2.46	0.46
1:I:344:ARG:CG	1:I:346:MET:CE	2.93	0.46
1:K:344:ARG:HG3	1:K:346:MET:HE2	1.96	0.46
1:J:109:HIS:O	1:J:123:ARG:HD3	2.16	0.46
1:B:76:ASP:O	1:B:78:VAL:HG23	2.16	0.46
1:C:6:LYS:CD	1:C:371:GLN:C	2.83	0.46
1:A:311:LEU:CG	1:A:315:TYR:HE2	2.20	0.45
1:B:109:HIS:CD2	1:C:208:HIS:HB3	2.51	0.45
1:D:125:CYS:SG	1:D:133:LYS:HE3	2.56	0.45
1:H:166:PRO:CB	1:H:231:GLN:HG3	2.39	0.45
1:J:87:PRO:HD2	1:J:113:PHE:CZ	2.51	0.45
1:K:42:LYS:HA	1:K:155:ASP:HB2	1.98	0.45
1:K:172:LEU:HG	1:K:179:ILE:HD11	1.98	0.45
1:K:258:PHE:HB2	4:K:403:QKQ:C17	2.46	0.45
1:B:199:ILE:HG22	1:B:283:GLU:OE2	2.16	0.45

*Continued on next page...*

*Continued from previous page...*

Atom-1	Atom-2	Interatomic distance (Å)	Clash overlap (Å)
1:G:237:TYR:OH	1:G:257:GLU:OE1	2.30	0.45
1:J:286:VAL:HB	1:J:290:THR:HB	1.98	0.45
1:J:296:ASP:HB3	1:J:298:TYR:CE2	2.51	0.45
1:D:346:MET:HE1	1:F:128:VAL:HG11	1.98	0.45
1:K:221:GLN:HB3	1:K:221:GLN:HE21	1.61	0.45
1:A:315:TYR:HA	1:A:319:PHE:HB3	1.98	0.45
1:A:35:GLU:O	1:A:39:ILE:HB	2.17	0.45
1:D:306:GLN:CD	1:D:309:LYS:HE3	2.36	0.45
1:D:31:VAL:O	1:D:35:GLU:HG3	2.16	0.45
1:E:212:ALA:CB	1:E:326:LEU:HD11	2.47	0.45
1:G:70:VAL:CG1	1:G:82:PHE:HB2	2.47	0.45
1:H:128:VAL:HG11	1:I:346:MET:HE1	1.99	0.45
1:J:122:ALA:HB3	1:J:125:CYS:HB2	1.99	0.45
1:K:216:PHE:CE1	1:K:219:SER:HB2	2.51	0.45
1:B:180:LYS:HB3	1:B:180:LYS:HE3	1.88	0.45
1:B:221:GLN:OE1	1:B:239:PHE:O	2.34	0.45
1:E:9:GLU:O	1:E:9:GLU:HG2	2.16	0.45
1:G:89:ARG:NH1	1:G:109:HIS:CE1	2.84	0.45
1:G:128:VAL:HG11	1:H:346:MET:HE1	1.99	0.45
1:K:76:ASP:C	6:K:516:HOH:O	2.54	0.45
1:A:171:ARG:O	1:A:174:GLN:HB2	2.17	0.45
1:D:220:VAL:HG13	1:D:220:VAL:O	2.17	0.45
1:E:86:CYS:SG	1:E:87:PRO:CD	3.04	0.45
1:F:340:ARG:HG3	6:F:534:HOH:O	2.17	0.45
1:H:344:ARG:HG3	1:H:346:MET:CE	2.47	0.45
1:I:146:TYR:CZ	1:I:169:ALA:HB2	2.52	0.45
1:D:258:PHE:CD1	4:D:403:QKQ:C15	3.00	0.45
1:E:75:LYS:HB3	1:E:75:LYS:HE2	1.80	0.45
1:L:101:LYS:HD2	1:L:101:LYS:N	2.29	0.45
1:F:279:THR:HA	1:F:296:ASP:O	2.17	0.45
1:K:56:PRO:HA	1:K:73:ARG:HG3	1.99	0.45
1:D:56:PRO:O	1:D:57:ASN:HB2	2.16	0.45
1:E:137:SER:O	1:F:340:ARG:NH2	2.44	0.45
1:F:349:LYS:HA	1:F:349:LYS:HD2	1.77	0.45
1:K:108:TYR:O	1:L:208:HIS:HB2	2.17	0.45
1:D:319:PHE:CZ	4:D:403:QKQ:C7	3.00	0.45
1:F:182:LEU:HB3	1:F:298:TYR:HB3	1.97	0.45
1:F:63:LYS:NZ	1:F:66:GLY:HA2	2.32	0.45
1:F:67:GLU:HA	1:F:67:GLU:OE2	2.17	0.45
1:H:352:SER:OG	1:H:353:GLY:N	2.49	0.45
1:I:42:LYS:HA	1:I:155:ASP:HB2	1.99	0.45

*Continued on next page...*

*Continued from previous page...*

Atom-1	Atom-2	Interatomic distance (Å)	Clash overlap (Å)
1:L:208:HIS:O	1:L:211:PRO:HD2	2.17	0.45
1:B:89:ARG:NH1	1:B:109:HIS:HE1	2.15	0.44
1:D:344:ARG:CG	1:D:346:MET:CE	2.95	0.44
1:I:27:THR:HG21	1:I:335:LYS:HG2	1.99	0.44
1:K:53:LEU:HD12	1:K:150:VAL:HG21	1.99	0.44
1:A:24:VAL:CG2	1:A:28:SER:HB2	2.47	0.44
1:B:110:ALA:HB2	1:C:211:PRO:HB3	1.99	0.44
1:F:32:PHE:CE2	1:F:287:ASP:HA	2.53	0.44
1:B:203:TYR:CG	1:B:268:MET:HG2	2.53	0.44
1:E:88:HIS:CE1	1:E:109:HIS:ND1	2.85	0.44
1:F:142:LYS:HE3	1:F:156:GLU:O	2.17	0.44
1:J:220:VAL:HG11	1:J:225:TYR:HD2	1.82	0.44
1:B:344:ARG:CG	1:B:346:MET:CE	2.95	0.44
1:E:108:TYR:CD1	1:F:326:LEU:HD22	2.53	0.44
1:G:219:SER:O	1:G:240:ALA:HA	2.18	0.44
1:G:334:LEU:HD12	1:G:334:LEU:C	2.38	0.44
1:G:83:TYR:CB	1:H:338:GLY:HA3	2.48	0.44
1:H:164:GLN:C	1:H:166:PRO:HD3	2.37	0.44
1:I:35:GLU:O	1:I:39:ILE:HB	2.18	0.44
1:J:80:ARG:HD2	1:J:116:ASP:HA	2.00	0.44
1:K:229:THR:OG1	1:K:361:TYR:CD1	2.70	0.44
1:C:168:PHE:CZ	1:C:172:LEU:HD22	2.52	0.44
1:F:146:TYR:CZ	1:F:169:ALA:HB2	2.53	0.44
1:G:272:PRO:HG3	4:G:403:QKQ:C1	2.48	0.44
1:H:344:ARG:HG3	1:H:346:MET:HE2	1.99	0.44
1:I:10:ASP:N	1:I:10:ASP:OD1	2.48	0.44
1:I:206:CYS:SG	1:I:225:TYR:OH	2.72	0.44
1:B:212:ALA:CB	1:B:326:LEU:HD11	2.47	0.44
1:B:295:TYR:OH	4:B:403:QKQ:C3	2.66	0.44
1:D:110:ALA:HB2	1:E:211:PRO:HB3	1.98	0.44
1:F:180:LYS:NZ	6:F:514:HOH:O	2.51	0.44
1:G:122:ALA:O	1:G:125:CYS:HB2	2.18	0.44
1:G:147:ALA:HB1	1:G:172:LEU:HD23	1.99	0.44
1:G:277:PHE:HB2	1:G:298:TYR:O	2.18	0.44
1:B:104:ILE:CD1	1:B:138:MET:HE1	2.42	0.44
1:B:88:HIS:CE1	1:B:109:HIS:ND1	2.85	0.44
1:C:265:PRO:HD2	6:C:527:HOH:O	2.16	0.44
1:C:216:PHE:HZ	4:C:403:QKQ:N3	2.15	0.44
1:F:253:VAL:HG12	1:F:254:THR:N	2.33	0.44
1:H:334:LEU:HD12	1:H:334:LEU:C	2.38	0.44
1:H:35:GLU:O	1:H:39:ILE:HB	2.17	0.44

*Continued on next page...*

*Continued from previous page...*

Atom-1	Atom-2	Interatomic distance (Å)	Clash overlap (Å)
1:H:87:PRO:HB3	1:I:340:ARG:HH12	1.82	0.44
1:J:122:ALA:O	1:J:125:CYS:CB	2.66	0.44
1:K:122:ALA:O	1:K:125:CYS:CB	2.65	0.44
1:A:109:HIS:HB2	3:A:402:FES:S2	2.58	0.44
1:B:47:VAL:HB	1:B:62:ARG:HG3	2.00	0.44
1:I:281:ILE:HG12	1:I:295:TYR:CD1	2.53	0.44
1:I:344:ARG:HG3	1:I:346:MET:CE	2.47	0.44
5:I:404:EPE:H21	5:I:404:EPE:H102	1.93	0.44
1:J:109:HIS:HD2	1:K:208:HIS:CA	2.30	0.44
1:L:281:ILE:HG12	1:L:295:TYR:HD1	1.83	0.44
1:L:342:GLN:OE1	5:L:404:EPE:H51	2.18	0.44
1:C:213:HIS:HB3	1:C:216:PHE:HB3	2.00	0.43
1:G:208:HIS:CB	1:I:109:HIS:CD2	2.94	0.43
1:I:14:ASN:ND2	1:I:17:VAL:HG12	2.33	0.43
1:I:147:ALA:HB1	1:I:172:LEU:HD23	2.00	0.43
1:C:295:TYR:OH	4:C:403:QKQ:C3	2.66	0.43
1:I:27:THR:HG23	1:I:334:LEU:HD11	2.00	0.43
1:K:168:PHE:CZ	1:K:172:LEU:HD22	2.53	0.43
1:K:208:HIS:CD2	1:K:208:HIS:C	2.92	0.43
1:B:139:VAL:HG21	1:C:338:GLY:O	2.17	0.43
1:C:347:THR:CG2	1:C:357:HIS:HB3	2.47	0.43
1:E:203:TYR:CG	1:E:268:MET:HG2	2.53	0.43
1:I:200:VAL:O	1:I:204:MET:HG2	2.19	0.43
1:K:179:ILE:HA	1:K:182:LEU:CD1	2.48	0.43
1:K:227:HIS:HE1	1:K:234:THR:HB	1.84	0.43
1:G:23:LYS:HD3	1:G:334:LEU:O	2.19	0.43
1:H:188:PHE:CZ	1:H:316:ARG:HB2	2.54	0.43
1:A:207:TYR:HE2	1:A:346:MET:HG3	1.83	0.43
1:C:24:VAL:CG2	1:C:28:SER:HB2	2.49	0.43
1:F:8:PRO:HD2	1:F:11:PHE:HB2	2.00	0.43
1:G:344:ARG:HG3	1:G:346:MET:CE	2.49	0.43
1:K:171:ARG:HA	1:K:174:GLN:OE1	2.19	0.43
1:L:36:LYS:HG3	1:L:65:ILE:HB	2.01	0.43
1:F:221:GLN:HB2	1:F:224:LYS:HB2	2.00	0.43
1:H:359:ILE:O	1:H:363:GLN:HG3	2.18	0.43
1:I:7:LEU:HG	1:I:25:PHE:CZ	2.54	0.43
1:J:258:PHE:HB3	1:J:273:PRO:HD3	1.99	0.43
1:K:40:PHE:CZ	1:K:285:PRO:HG2	2.54	0.43
1:L:87:PRO:HD2	1:L:113:PHE:CZ	2.54	0.43
1:L:63:LYS:HA	1:L:67:GLU:O	2.19	0.43
1:L:86:CYS:SG	1:L:87:PRO:N	2.91	0.43

*Continued on next page...*



*Continued from previous page...*

Atom-1	Atom-2	Interatomic distance (Å)	Clash overlap (Å)
1:B:86:CYS:SG	1:B:87:PRO:HD2	2.59	0.43
1:D:277:PHE:HB2	1:D:298:TYR:O	2.18	0.43
1:D:86:CYS:SG	1:D:87:PRO:HD2	2.59	0.43
1:H:70:VAL:HG12	1:H:82:PHE:O	2.19	0.43
1:H:56:PRO:HA	1:H:73:ARG:HG3	2.01	0.43
1:D:108:TYR:CD1	1:E:326:LEU:HD22	2.54	0.43
1:G:168:PHE:CZ	1:G:172:LEU:HD22	2.53	0.43
1:I:231:GLN:O	1:I:232:ASN:HB2	2.19	0.43
1:K:115:LEU:HD23	1:K:115:LEU:N	2.34	0.43
1:J:75:LYS:HE2	1:J:75:LYS:HB3	1.71	0.43
1:A:344:ARG:HG3	1:A:346:MET:HE2	2.00	0.43
1:F:344:ARG:HG3	1:F:346:MET:HE2	2.00	0.43
1:K:209:CYS:SG	1:K:213:HIS:HD2	2.42	0.43
1:D:220:VAL:O	1:D:220:VAL:CG1	2.67	0.42
1:J:108:TYR:O	1:K:208:HIS:HB2	2.19	0.42
1:B:218:ASP:HB2	1:B:241:ARG:NH1	2.34	0.42
1:I:216:PHE:HE1	4:I:403:QKQ:C17	2.32	0.42
1:J:338:GLY:HA3	1:L:83:TYR:CB	2.49	0.42
1:D:224:LYS:HA	1:D:226:TRP:CH2	2.54	0.42
1:G:220:VAL:HG13	1:G:225:TYR:HD2	1.83	0.42
1:H:33:GLU:HB3	6:H:504:HOH:O	2.19	0.42
1:J:23:LYS:HD3	1:J:334:LEU:O	2.19	0.42
1:J:46:CYS:HB2	1:J:151:PHE:CE2	2.54	0.42
1:K:54:ALA:HA	6:K:506:HOH:O	2.19	0.42
1:L:254:THR:HG23	1:L:256:PRO:HD3	2.01	0.42
1:A:31:VAL:O	1:A:35:GLU:HG3	2.20	0.42
1:B:133:LYS:HE2	1:B:133:LYS:HB2	1.88	0.42
1:B:193:PRO:HA	1:B:289:GLU:O	2.20	0.42
1:E:216:PHE:O	1:E:216:PHE:CG	2.71	0.42
1:E:344:ARG:HG3	1:E:346:MET:HE2	2.01	0.42
1:G:345:ILE:O	6:G:501:HOH:O	2.21	0.42
1:G:76:ASP:O	1:G:77:SER:HB2	2.19	0.42
1:B:190:THR:HG23	6:B:556:HOH:O	2.19	0.42
1:E:313:GLU:OE2	1:E:316:ARG:HD2	2.18	0.42
1:G:4:VAL:O	1:G:4:VAL:HG23	2.20	0.42
1:L:75:LYS:HE2	1:L:75:LYS:HA	2.01	0.42
1:B:281:ILE:HG12	1:B:295:TYR:CD1	2.54	0.42
1:C:8:PRO:HD2	1:C:11:PHE:HB2	2.01	0.42
1:F:257:GLU:O	1:F:273:PRO:HA	2.18	0.42
1:H:344:ARG:CG	1:H:346:MET:HE3	2.50	0.42
1:H:80:ARG:HD2	6:H:517:HOH:O	2.18	0.42

*Continued on next page...*

*Continued from previous page...*

Atom-1	Atom-2	Interatomic distance (Å)	Clash overlap (Å)
1:K:36:LYS:HG3	1:K:65:ILE:HB	2.00	0.42
1:A:323:ASP:OD2	4:A:403:QKQ:N1	2.53	0.42
1:C:281:ILE:HG12	1:C:295:TYR:CD1	2.55	0.42
1:D:196:TRP:CE2	1:D:197:LYS:HG3	2.55	0.42
1:F:44:TRP:CE3	1:F:153:ASN:HB2	2.54	0.42
1:H:104:ILE:O	1:H:112:THR:HA	2.19	0.42
1:I:44:TRP:CE3	1:I:153:ASN:HB2	2.54	0.42
1:B:36:LYS:NZ	6:B:506:HOH:O	2.53	0.42
1:B:85:VAL:HG21	1:C:333:GLY:O	2.19	0.42
1:C:6:LYS:HD2	1:C:371:GLN:O	2.19	0.42
1:D:17:VAL:O	1:D:17:VAL:CG2	2.67	0.42
1:E:253:VAL:HG12	1:E:254:THR:N	2.34	0.42
1:G:4:VAL:HG23	1:G:6:LYS:HD2	2.01	0.42
1:I:261:PHE:O	1:I:268:MET:HA	2.20	0.42
1:J:208:HIS:HB3	1:L:109:HIS:NE2	2.35	0.42
1:J:220:VAL:CG1	1:J:225:TYR:HD2	2.33	0.42
1:A:216:PHE:CZ	4:A:403:QKQ:C15	2.93	0.42
1:A:5:GLU:HG2	1:A:24:VAL:HG11	2.01	0.42
1:B:134:GLU:O	1:B:135:ASN:HB2	2.20	0.42
1:C:319:PHE:HE2	4:C:403:QKQ:C4	2.33	0.42
1:D:70:VAL:HG21	1:D:94:LEU:HD12	2.01	0.42
1:I:55:GLN:OE1	1:I:55:GLN:HA	2.19	0.42
1:J:359:ILE:O	1:J:363:GLN:HG3	2.20	0.42
1:K:271:VAL:CG1	1:K:275:SER:HA	2.49	0.42
1:C:113:PHE:CG	1:C:138:MET:HE2	2.55	0.42
1:L:117:GLY:O	1:L:137:SER:HB2	2.20	0.42
1:A:7:LEU:HG	1:A:25:PHE:CZ	2.55	0.41
1:A:277:PHE:HB2	1:A:298:TYR:O	2.20	0.41
1:B:257:GLU:O	1:B:273:PRO:HA	2.20	0.41
1:D:286:VAL:HB	1:D:290:THR:HB	2.02	0.41
1:D:131:PHE:HD1	1:E:346:MET:HE1	1.85	0.41
1:F:311:LEU:HG	1:F:315:TYR:HE2	1.84	0.41
1:H:83:TYR:CB	1:I:338:GLY:HA3	2.50	0.41
1:J:279:THR:HA	1:J:296:ASP:O	2.20	0.41
1:L:42:LYS:HA	1:L:155:ASP:HB2	2.01	0.41
1:L:67:GLU:HA	1:L:67:GLU:OE2	2.20	0.41
1:A:36:LYS:HG3	1:A:65:ILE:HB	2.02	0.41
1:B:114:LYS:HE2	1:B:118:SER:OG	2.20	0.41
1:B:344:ARG:HG3	1:B:346:MET:CE	2.50	0.41
1:H:109:HIS:NE2	1:I:208:HIS:HB3	2.35	0.41
1:K:224:LYS:HB3	1:K:239:PHE:HD2	1.85	0.41

*Continued on next page...*

*Continued from previous page...*

Atom-1	Atom-2	Interatomic distance (Å)	Clash overlap (Å)
1:L:109:HIS:HB2	3:L:402:FES:S2	2.60	0.41
4:L:403:QKQ:C1	4:L:403:QKQ:N4	2.83	0.41
1:L:80:ARG:HD2	1:L:116:ASP:HA	2.02	0.41
1:L:8:PRO:HD2	1:L:11:PHE:HB2	2.03	0.41
1:A:44:TRP:CE3	1:A:153:ASN:HB2	2.55	0.41
1:B:83:TYR:CB	1:C:338:GLY:HA3	2.50	0.41
1:A:338:GLY:HA3	1:C:83:TYR:CB	2.49	0.41
1:D:22:PRO:HA	1:D:342:GLN:HG2	2.02	0.41
1:J:221:GLN:CG	1:J:224:LYS:HB2	2.45	0.41
1:K:80:ARG:HD2	6:K:510:HOH:O	2.19	0.41
1:L:111:TRP:CG	3:L:402:FES:S2	3.13	0.41
1:L:347:THR:HG23	1:L:357:HIS:HB3	2.02	0.41
1:B:160:CYS:HB2	6:B:528:HOH:O	2.20	0.41
1:E:152:ILE:HD12	1:E:152:ILE:C	2.40	0.41
1:G:216:PHE:CG	1:G:216:PHE:O	2.74	0.41
1:G:97:SER:OG	6:G:502:HOH:O	2.22	0.41
1:J:133:LYS:HB3	1:J:133:LYS:HE3	1.78	0.41
1:A:24:VAL:HG23	1:A:28:SER:HB2	2.03	0.41
1:C:26:TYR:OH	1:C:201:ASP:OD2	2.32	0.41
1:G:75:LYS:HE2	1:G:102:ASN:ND2	2.35	0.41
1:G:315:TYR:OH	4:G:403:QKQ:C1	2.68	0.41
1:G:80:ARG:HD2	1:G:116:ASP:HA	2.03	0.41
1:J:236:GLN:OE1	4:J:403:QKQ:C11	2.69	0.41
1:J:257:GLU:O	1:J:273:PRO:HA	2.20	0.41
1:L:286:VAL:HB	1:L:290:THR:HB	2.03	0.41
1:B:261:PHE:O	1:B:268:MET:HA	2.19	0.41
1:B:340:ARG:HB3	5:B:404:EPE:O2S	2.21	0.41
1:C:346:MET:HA	1:C:346:MET:HE2	2.02	0.41
1:F:122:ALA:O	1:F:125:CYS:HB2	2.20	0.41
1:F:119:LEU:HD22	1:F:136:SER:HB2	2.03	0.41
1:G:271:VAL:HG12	1:G:275:SER:HA	2.01	0.41
4:H:403:QKQ:N5	4:H:403:QKQ:C21	2.82	0.41
1:J:147:ALA:HB1	1:J:172:LEU:HD23	2.03	0.41
1:K:205:GLU:HG2	1:K:359:ILE:HD11	2.02	0.41
1:B:164:GLN:C	1:B:166:PRO:HD3	2.40	0.41
1:D:109:HIS:HD2	1:E:208:HIS:N	2.18	0.41
1:E:17:VAL:O	1:E:17:VAL:CG2	2.67	0.41
1:G:26:TYR:CD1	1:G:198:VAL:HG23	2.56	0.41
1:K:57:ASN:N	1:K:73:ARG:O	2.40	0.41
1:C:135:ASN:HD22	1:C:135:ASN:N	2.18	0.41
1:C:80:ARG:HD2	1:C:116:ASP:HA	2.02	0.41

*Continued on next page...*

*Continued from previous page...*

Atom-1	Atom-2	Interatomic distance (Å)	Clash overlap (Å)
1:F:200:VAL:O	1:F:204:MET:HG2	2.20	0.41
1:H:311:LEU:HA	1:H:311:LEU:HD12	1.87	0.41
4:J:403:QKQ:N5	4:J:403:QKQ:C21	2.84	0.41
1:K:359:ILE:O	1:K:363:GLN:HG3	2.20	0.41
1:L:59:TYR:HA	1:L:71:ILE:O	2.21	0.41
1:L:61:THR:HA	1:L:69:ILE:O	2.20	0.41
1:C:21:PHE:HB3	1:C:25:PHE:HB2	2.02	0.41
1:I:122:ALA:O	1:I:125:CYS:CB	2.69	0.41
1:J:206:CYS:HA	1:J:209:CYS:SG	2.61	0.41
1:J:35:GLU:O	1:J:39:ILE:HB	2.21	0.41
1:L:26:TYR:CD1	1:L:198:VAL:HG23	2.56	0.41
1:L:322:GLU:O	1:L:326:LEU:HG	2.20	0.41
1:B:115:LEU:HD23	1:B:115:LEU:N	2.35	0.41
1:B:213:HIS:CB	1:B:216:PHE:HB3	2.42	0.41
1:F:6:LYS:HE3	1:F:371:GLN:OXT	2.21	0.41
1:G:322:GLU:O	1:G:326:LEU:HG	2.21	0.41
1:H:279:THR:HA	1:H:296:ASP:O	2.20	0.41
1:I:177:GLY:C	6:I:523:HOH:O	2.58	0.41
1:J:338:GLY:HA3	1:L:83:TYR:CG	2.55	0.41
1:K:262:TRP:HD1	1:K:268:MET:CE	2.33	0.41
1:K:59:TYR:HA	1:K:71:ILE:O	2.21	0.41
1:B:63:LYS:HA	1:B:67:GLU:O	2.21	0.41
1:E:274:GLY:N	6:E:523:HOH:O	2.52	0.41
1:I:224:LYS:HA	1:I:224:LYS:HD2	1.76	0.41
1:I:281:ILE:HG12	1:I:295:TYR:HD1	1.86	0.41
1:C:134:GLU:HG2	1:C:137:SER:CB	2.50	0.40
1:D:23:LYS:NZ	1:D:336:SER:O	2.54	0.40
1:E:281:ILE:HG12	1:E:295:TYR:CD1	2.56	0.40
1:F:121:LEU:HD22	1:F:122:ALA:N	2.36	0.40
1:G:132:ASP:CG	1:G:135:ASN:HB2	2.42	0.40
1:G:319:PHE:HE2	4:G:403:QKQ:C4	2.33	0.40
1:H:212:ALA:CB	1:H:326:LEU:HD11	2.51	0.40
1:H:348:ASP:OD1	1:H:351:ARG:N	2.54	0.40
1:J:123:ARG:HD3	1:J:123:ARG:HH11	1.76	0.40
1:C:206:CYS:SG	1:C:225:TYR:CZ	3.07	0.40
1:C:216:PHE:HE1	4:C:403:QKQ:C18	2.34	0.40
1:F:344:ARG:HG2	1:F:346:MET:CE	2.49	0.40
1:H:76:ASP:O	1:H:77:SER:HB2	2.22	0.40
1:I:188:PHE:CZ	1:I:316:ARG:HB2	2.56	0.40
1:J:119:LEU:HD21	1:J:122:ALA:HB2	2.04	0.40
1:K:27:THR:HG21	1:K:335:LYS:HG2	2.02	0.40

*Continued on next page...*

*Continued from previous page...*

Atom-1	Atom-2	Interatomic distance (Å)	Clash overlap (Å)
1:K:318:VAL:O	1:K:322:GLU:HG3	2.21	0.40
1:L:40:PHE:CZ	1:L:285:PRO:HG2	2.56	0.40
1:B:272:PRO:HG3	4:B:403:QKQ:C1	2.51	0.40
1:E:272:PRO:CB	1:E:273:PRO:HD2	2.52	0.40
1:F:64:VAL:O	1:F:65:ILE:HG13	2.21	0.40
1:G:368:GLN:HA	1:G:371:GLN:HE22	1.85	0.40
1:G:109:HIS:NE2	1:H:208:HIS:HB3	2.36	0.40
1:J:193:PRO:HA	1:J:289:GLU:O	2.21	0.40
1:K:260:GLY:HA3	4:K:403:QKQ:C15	2.52	0.40
1:A:216:PHE:CE1	4:A:403:QKQ:C16	3.00	0.40
1:B:168:PHE:HE1	1:B:261:PHE:CD2	2.40	0.40
1:B:271:VAL:HG12	1:B:275:SER:HA	2.04	0.40
1:C:188:PHE:CZ	1:C:316:ARG:HB2	2.56	0.40
1:C:63:LYS:N	6:C:504:HOH:O	2.31	0.40
1:H:119:LEU:HD21	1:H:122:ALA:HB2	2.03	0.40
1:J:326:LEU:HD22	1:L:108:TYR:CD1	2.57	0.40
1:K:271:VAL:HG22	1:K:278:MET:HG2	2.03	0.40
1:K:306:GLN:OE1	1:K:306:GLN:HA	2.20	0.40
1:A:164:GLN:C	1:A:166:PRO:HD3	2.42	0.40
1:A:287:ASP:HB2	6:A:538:HOH:O	2.20	0.40
1:D:127:HIS:CG	1:E:350:GLN:HE22	2.39	0.40
1:F:180:LYS:HD3	1:F:180:LYS:HA	1.84	0.40
1:H:271:VAL:HG12	1:H:275:SER:HA	2.03	0.40
1:G:346:MET:HE1	1:I:128:VAL:HG11	2.03	0.40
1:J:220:VAL:HG11	1:J:225:TYR:CD2	2.56	0.40
1:L:134:GLU:H	1:L:134:GLU:CD	2.24	0.40
1:L:345:ILE:HG23	1:L:356:GLU:HB3	2.02	0.40

There are no symmetry-related clashes.

## 5.3 Torsion angles [i](#)

### 5.3.1 Protein backbone [i](#)

In the following table, the Percentiles column shows the percent Ramachandran outliers of the chain as a percentile score with respect to all X-ray entries followed by that with respect to entries of similar resolution.

The Analysed column shows the number of residues for which the backbone conformation was analysed, and the total number of residues.

Mol	Chain	Analysed	Favoured	Allowed	Outliers	Percentiles	
1	A	356/391 (91%)	336 (94%)	19 (5%)	1 (0%)	41	37
1	B	353/391 (90%)	333 (94%)	19 (5%)	1 (0%)	41	37
1	C	353/391 (90%)	334 (95%)	16 (4%)	3 (1%)	19	13
1	D	356/391 (91%)	335 (94%)	18 (5%)	3 (1%)	19	13
1	E	356/391 (91%)	337 (95%)	19 (5%)	0	100	100
1	F	355/391 (91%)	336 (95%)	19 (5%)	0	100	100
1	G	359/391 (92%)	345 (96%)	13 (4%)	1 (0%)	41	37
1	H	354/391 (90%)	337 (95%)	17 (5%)	0	100	100
1	I	354/391 (90%)	339 (96%)	15 (4%)	0	100	100
1	J	352/391 (90%)	335 (95%)	17 (5%)	0	100	100
1	K	355/391 (91%)	335 (94%)	18 (5%)	2 (1%)	25	19
1	L	354/391 (90%)	334 (94%)	20 (6%)	0	100	100
All	All	4257/4692 (91%)	4036 (95%)	210 (5%)	11 (0%)	41	37

All (11) Ramachandran outliers are listed below:

Mol	Chain	Res	Type
1	A	241	ARG
1	B	135	ASN
1	D	341	GLY
1	K	341	GLY
1	C	133	LYS
1	D	219	SER
1	G	243	SER
1	C	135	ASN
1	C	219	SER
1	D	123	ARG
1	K	255	ASP

### 5.3.2 Protein sidechains [i](#)

In the following table, the Percentiles column shows the percent sidechain outliers of the chain as a percentile score with respect to all X-ray entries followed by that with respect to entries of similar resolution.

The Analysed column shows the number of residues for which the sidechain conformation was analysed, and the total number of residues.

Mol	Chain	Analysed	Rotameric	Outliers	Percentiles	
1	A	314/342 (92%)	306 (98%)	8 (2%)	47	49
1	B	311/342 (91%)	302 (97%)	9 (3%)	42	43
1	C	311/342 (91%)	302 (97%)	9 (3%)	42	43
1	D	314/342 (92%)	304 (97%)	10 (3%)	39	38
1	E	314/342 (92%)	303 (96%)	11 (4%)	36	35
1	F	313/342 (92%)	307 (98%)	6 (2%)	57	61
1	G	317/342 (93%)	310 (98%)	7 (2%)	52	55
1	H	312/342 (91%)	301 (96%)	11 (4%)	36	35
1	I	312/342 (91%)	300 (96%)	12 (4%)	33	31
1	J	310/342 (91%)	299 (96%)	11 (4%)	36	35
1	K	313/342 (92%)	304 (97%)	9 (3%)	42	43
1	L	312/342 (91%)	304 (97%)	8 (3%)	46	48
All	All	3753/4104 (91%)	3642 (97%)	111 (3%)	41	41

All (111) residues with a non-rotameric sidechain are listed below:

Mol	Chain	Res	Type
1	A	9	GLU
1	A	101	LYS
1	A	108	TYR
1	A	205	GLU
1	A	241	ARG
1	A	243	SER
1	A	268	MET
1	A	349	LYS
1	B	108	TYR
1	B	141	LEU
1	B	180	LYS
1	B	223	ASP
1	B	231	GLN
1	B	268	MET
1	B	294	HIS
1	B	323	ASP
1	B	371	GLN
1	C	55	GLN
1	C	108	TYR
1	C	135	ASN
1	C	157	ASN
1	C	180	LYS

*Continued on next page...*

*Continued from previous page...*

<b>Mol</b>	<b>Chain</b>	<b>Res</b>	<b>Type</b>
1	C	205	GLU
1	C	219	SER
1	C	224	LYS
1	C	268	MET
1	D	6	LYS
1	D	108	TYR
1	D	205	GLU
1	D	237	TYR
1	D	243	SER
1	D	255	ASP
1	D	268	MET
1	D	303	GLU
1	D	350	GLN
1	D	371	GLN
1	E	99	LYS
1	E	101	LYS
1	E	108	TYR
1	E	135	ASN
1	E	141	LEU
1	E	205	GLU
1	E	231	GLN
1	E	237	TYR
1	E	268	MET
1	E	349	LYS
1	E	371	GLN
1	F	9	GLU
1	F	108	TYR
1	F	205	GLU
1	F	231	GLN
1	F	268	MET
1	F	340	ARG
1	G	108	TYR
1	G	118	SER
1	G	205	GLU
1	G	242	SER
1	G	246	SER
1	G	247	PHE
1	G	268	MET
1	H	75	LYS
1	H	99	LYS
1	H	108	TYR
1	H	114	LYS

*Continued on next page...*



*Continued from previous page...*

<b>Mol</b>	<b>Chain</b>	<b>Res</b>	<b>Type</b>
1	H	205	GLU
1	H	220	VAL
1	H	224	LYS
1	H	268	MET
1	H	307	ASP
1	H	352	SER
1	H	371	GLN
1	I	108	TYR
1	I	180	LYS
1	I	205	GLU
1	I	219	SER
1	I	221	GLN
1	I	222	VAL
1	I	223	ASP
1	I	224	LYS
1	I	268	MET
1	I	304	LEU
1	I	306	GLN
1	I	350	GLN
1	J	10	ASP
1	J	106	CYS
1	J	108	TYR
1	J	141	LEU
1	J	205	GLU
1	J	222	VAL
1	J	225	TYR
1	J	255	ASP
1	J	268	MET
1	J	349	LYS
1	J	350	GLN
1	K	63	LYS
1	K	108	TYR
1	K	114	LYS
1	K	205	GLU
1	K	223	ASP
1	K	227	HIS
1	K	228	THR
1	K	229	THR
1	K	268	MET
1	L	99	LYS
1	L	101	LYS
1	L	108	TYR

*Continued on next page...*

*Continued from previous page...*

Mol	Chain	Res	Type
1	L	205	GLU
1	L	219	SER
1	L	231	GLN
1	L	241	ARG
1	L	268	MET

Some sidechains can be flipped to improve hydrogen bonding and reduce clashes. All (25) such sidechains are listed below:

Mol	Chain	Res	Type
1	B	57	ASN
1	B	135	ASN
1	B	221	GLN
1	B	231	GLN
1	B	236	GLN
1	C	135	ASN
1	C	221	GLN
1	D	157	ASN
1	D	371	GLN
1	E	221	GLN
1	F	157	ASN
1	G	306	GLN
1	H	157	ASN
1	I	306	GLN
1	J	221	GLN
1	K	55	GLN
1	K	221	GLN
1	K	227	HIS
1	K	236	GLN
1	K	371	GLN
1	L	135	ASN
1	L	157	ASN
1	L	221	GLN
1	L	231	GLN
1	L	371	GLN

### 5.3.3 RNA [i](#)

There are no RNA molecules in this entry.

## 5.4 Non-standard residues in protein, DNA, RNA chains [i](#)

There are no non-standard protein/DNA/RNA residues in this entry.

## 5.5 Carbohydrates [i](#)

There are no monosaccharides in this entry.

## 5.6 Ligand geometry [i](#)

Of 48 ligands modelled in this entry, 12 are monoatomic - leaving 36 for Mogul analysis.

In the following table, the Counts columns list the number of bonds (or angles) for which Mogul statistics could be retrieved, the number of bonds (or angles) that are observed in the model and the number of bonds (or angles) that are defined in the Chemical Component Dictionary. The Link column lists molecule types, if any, to which the group is linked. The Z score for a bond length (or angle) is the number of standard deviations the observed value is removed from the expected value. A bond length (or angle) with  $|Z| > 2$  is considered an outlier worth inspection. RMSZ is the root-mean-square of all Z scores of the bond lengths (or angles).

Mol	Type	Chain	Res	Link	Bond lengths			Bond angles		
					Counts	RMSZ	# Z  > 2	Counts	RMSZ	# Z  > 2
4	QKQ	G	403	2	30,32,32	0.88	2 (6%)	40,43,43	0.97	2 (5%)
3	FES	K	402	1	0,4,4	0.00	-	-		
4	QKQ	A	403	2	30,32,32	1.01	1 (3%)	40,43,43	1.41	6 (15%)
3	FES	D	402	1	0,4,4	0.00	-	-		
4	QKQ	E	403	2	30,32,32	0.62	0	40,43,43	0.98	1 (2%)
5	EPE	A	404	-	15,15,15	1.00	1 (6%)	18,20,20	1.81	5 (27%)
3	FES	H	402	1	0,4,4	0.00	-	-		
5	EPE	B	404	-	15,15,15	1.17	1 (6%)	18,20,20	1.71	6 (33%)
5	EPE	E	404	-	15,15,15	1.21	1 (6%)	18,20,20	2.15	5 (27%)
4	QKQ	H	403	2	30,32,32	0.42	0	40,43,43	0.96	2 (5%)
4	QKQ	L	403	2	30,32,32	0.76	1 (3%)	40,43,43	1.09	4 (10%)
4	QKQ	C	403	2	30,32,32	0.63	0	40,43,43	0.96	3 (7%)
4	QKQ	D	403	2	30,32,32	0.49	0	40,43,43	0.84	2 (5%)
3	FES	G	402	1	0,4,4	0.00	-	-		
3	FES	I	402	1	0,4,4	0.00	-	-		
3	FES	B	402	1	0,4,4	0.00	-	-		
3	FES	L	402	1	0,4,4	0.00	-	-		
5	EPE	G	404	-	15,15,15	1.27	1 (6%)	18,20,20	2.02	5 (27%)
5	EPE	C	404	-	15,15,15	1.35	1 (6%)	18,20,20	1.81	4 (22%)

Mol	Type	Chain	Res	Link	Bond lengths			Bond angles		
					Counts	RMSZ	# Z  > 2	Counts	RMSZ	# Z  > 2
4	QKQ	K	403	2	30,32,32	0.74	1 (3%)	40,43,43	1.44	5 (12%)
4	QKQ	F	403	2	30,32,32	0.69	1 (3%)	40,43,43	1.45	3 (7%)
4	QKQ	I	403	2	30,32,32	0.58	0	40,43,43	1.29	3 (7%)
4	QKQ	B	403	2	30,32,32	0.67	1 (3%)	40,43,43	0.99	2 (5%)
5	EPE	L	404	-	15,15,15	1.05	1 (6%)	18,20,20	1.86	4 (22%)
3	FES	F	402	1	0,4,4	0.00	-	-	-	-
5	EPE	H	404	-	15,15,15	1.39	1 (6%)	18,20,20	2.06	4 (22%)
3	FES	J	402	1	0,4,4	0.00	-	-	-	-
3	FES	E	402	1	0,4,4	0.00	-	-	-	-
4	QKQ	J	403	2	30,32,32	0.67	1 (3%)	40,43,43	0.75	1 (2%)
3	FES	A	402	1	0,4,4	0.00	-	-	-	-
5	EPE	I	404	-	15,15,15	1.03	1 (6%)	18,20,20	1.81	6 (33%)
5	EPE	K	404	-	15,15,15	1.29	1 (6%)	18,20,20	1.63	3 (16%)
5	EPE	J	404	-	15,15,15	1.24	1 (6%)	18,20,20	1.81	5 (27%)
5	EPE	D	404	-	15,15,15	1.19	1 (6%)	18,20,20	1.56	4 (22%)
5	EPE	F	404	-	15,15,15	1.23	1 (6%)	18,20,20	2.16	6 (33%)
3	FES	C	402	1	0,4,4	0.00	-	-	-	-

In the following table, the Chirals column lists the number of chiral outliers, the number of chiral centers analysed, the number of these observed in the model and the number defined in the Chemical Component Dictionary. Similar counts are reported in the Torsion and Rings columns. '-' means no outliers of that kind were identified.

Mol	Type	Chain	Res	Link	Chirals	Torsions	Rings
3	FES	G	402	1	-	-	0/1/1/1
3	FES	K	402	1	-	-	0/1/1/1
4	QKQ	A	403	2	-	8/17/17/17	0/4/4/4
3	FES	D	402	1	-	-	0/1/1/1
3	FES	I	402	1	-	-	0/1/1/1
5	EPE	A	404	-	-	2/9/19/19	0/1/1/1
3	FES	H	402	1	-	-	0/1/1/1
5	EPE	B	404	-	-	2/9/19/19	0/1/1/1
5	EPE	E	404	-	-	3/9/19/19	0/1/1/1
4	QKQ	H	403	2	-	1/17/17/17	0/4/4/4
4	QKQ	L	403	2	-	0/17/17/17	0/4/4/4
4	QKQ	C	403	2	-	3/17/17/17	0/4/4/4
4	QKQ	D	403	2	-	4/17/17/17	0/4/4/4
4	QKQ	G	403	2	-	3/17/17/17	0/4/4/4

Continued on next page...

Continued from previous page...

Mol	Type	Chain	Res	Link	Chirals	Torsions	Rings
4	QKQ	E	403	2	-	5/17/17/17	0/4/4/4
3	FES	B	402	1	-	-	0/1/1/1
3	FES	L	402	1	-	-	0/1/1/1
5	EPE	G	404	-	-	3/9/19/19	0/1/1/1
5	EPE	C	404	-	-	1/9/19/19	0/1/1/1
4	QKQ	K	403	2	-	5/17/17/17	0/4/4/4
4	QKQ	F	403	2	-	3/17/17/17	0/4/4/4
4	QKQ	I	403	2	-	4/17/17/17	0/4/4/4
4	QKQ	B	403	2	-	5/17/17/17	0/4/4/4
5	EPE	L	404	-	-	2/9/19/19	0/1/1/1
3	FES	F	402	1	-	-	0/1/1/1
5	EPE	H	404	-	-	1/9/19/19	0/1/1/1
3	FES	J	402	1	-	-	0/1/1/1
3	FES	E	402	1	-	-	0/1/1/1
4	QKQ	J	403	2	-	0/17/17/17	0/4/4/4
3	FES	A	402	1	-	-	0/1/1/1
5	EPE	I	404	-	-	2/9/19/19	0/1/1/1
5	EPE	K	404	-	-	3/9/19/19	0/1/1/1
5	EPE	J	404	-	-	2/9/19/19	0/1/1/1
5	EPE	D	404	-	-	2/9/19/19	0/1/1/1
5	EPE	F	404	-	-	2/9/19/19	0/1/1/1
3	FES	C	402	1	-	-	0/1/1/1

All (20) bond length outliers are listed below:

Mol	Chain	Res	Type	Atoms	Z	Observed(Å)	Ideal(Å)
5	H	404	EPE	C10-S	5.06	1.84	1.77
5	C	404	EPE	C10-S	4.79	1.84	1.77
5	K	404	EPE	C10-S	4.66	1.84	1.77
5	F	404	EPE	C10-S	4.43	1.83	1.77
5	G	404	EPE	C10-S	4.42	1.83	1.77
5	J	404	EPE	C10-S	4.29	1.83	1.77
5	E	404	EPE	C10-S	4.15	1.83	1.77
5	D	404	EPE	C10-S	4.14	1.83	1.77
5	B	404	EPE	C10-S	4.10	1.83	1.77
4	A	403	QKQ	C8-C9	-4.07	1.33	1.41
5	L	404	EPE	C10-S	3.58	1.82	1.77
5	I	404	EPE	C10-S	3.52	1.82	1.77
5	A	404	EPE	C10-S	3.31	1.82	1.77
4	G	403	QKQ	C8-C9	-2.98	1.35	1.41

Continued on next page...

*Continued from previous page...*

Mol	Chain	Res	Type	Atoms	Z	Observed(Å)	Ideal(Å)
4	L	403	QKQ	C20-N5	-2.40	1.32	1.37
4	K	403	QKQ	C8-C9	-2.39	1.37	1.41
4	G	403	QKQ	C20-N5	-2.36	1.32	1.37
4	B	403	QKQ	C20-N5	-2.30	1.32	1.37
4	J	403	QKQ	C20-N5	-2.28	1.32	1.37
4	F	403	QKQ	C20-N5	-2.28	1.32	1.37

All (91) bond angle outliers are listed below:

Mol	Chain	Res	Type	Atoms	Z	Observed(°)	Ideal(°)
5	H	404	EPE	O2S-S-C10	6.67	114.95	106.92
5	E	404	EPE	O1S-S-C10	6.51	114.75	106.92
5	G	404	EPE	O1S-S-C10	6.02	114.17	106.92
4	F	403	QKQ	C5-C6-C20	-5.45	114.92	122.20
5	F	404	EPE	O2S-S-C10	5.29	113.28	106.92
5	L	404	EPE	O3S-S-C10	4.95	113.78	105.77
5	C	404	EPE	O1S-S-C10	4.92	112.84	106.92
5	J	404	EPE	O3S-S-C10	4.68	113.33	105.77
4	F	403	QKQ	C7-C6-C5	4.56	126.19	119.61
5	A	404	EPE	O2S-S-C10	4.44	112.26	106.92
4	K	403	QKQ	C6-C20-C9	-4.27	116.81	119.23
5	I	404	EPE	O3S-S-C10	4.26	112.65	105.77
5	F	404	EPE	O1S-S-C10	4.19	111.96	106.92
5	D	404	EPE	O3S-S-C10	4.08	112.36	105.77
4	A	403	QKQ	C6-C20-C9	-4.06	116.93	119.23
5	K	404	EPE	O2S-S-C10	4.06	111.80	106.92
5	B	404	EPE	O3S-S-C10	4.02	112.26	105.77
4	I	403	QKQ	C5-C6-C20	-3.91	116.98	122.20
4	E	403	QKQ	C8-N1-C7	3.80	120.09	116.87
4	I	403	QKQ	C8-N1-C7	3.79	120.08	116.87
4	K	403	QKQ	C5-C6-C20	3.75	127.22	122.20
4	K	403	QKQ	C6-C20-N5	3.35	122.81	118.96
4	L	403	QKQ	C8-N1-C7	3.31	119.68	116.87
4	I	403	QKQ	C7-C6-C5	3.31	124.39	119.61
4	C	403	QKQ	C8-N1-C7	3.27	119.65	116.87
4	K	403	QKQ	C7-C6-C5	-3.21	114.99	119.61
5	L	404	EPE	C7-N4-C3	3.18	119.36	111.23
5	C	404	EPE	C7-N4-C5	3.12	119.22	111.23
4	A	403	QKQ	C6-C20-N5	3.10	122.53	118.96
4	G	403	QKQ	C8-N1-C7	3.09	119.49	116.87
5	F	404	EPE	C5-C6-N1	-3.08	104.33	110.64
4	B	403	QKQ	C8-N1-C7	3.07	119.47	116.87

*Continued on next page...*

*Continued from previous page...*

Mol	Chain	Res	Type	Atoms	Z	Observed(°)	Ideal(°)
5	I	404	EPE	C5-C6-N1	-3.03	104.43	110.64
4	H	403	QKQ	C8-N1-C7	3.01	119.43	116.87
5	E	404	EPE	O2S-S-C10	3.01	110.54	106.92
4	F	403	QKQ	C8-N1-C7	3.00	119.41	116.87
5	A	404	EPE	C5-C6-N1	-2.98	104.53	110.64
4	L	403	QKQ	C7-C6-C5	2.88	123.76	119.61
4	D	403	QKQ	C8-N1-C7	2.76	119.21	116.87
5	G	404	EPE	C5-C6-N1	-2.76	104.97	110.64
5	A	404	EPE	C5-N4-C3	2.76	115.04	108.83
4	A	403	QKQ	C11-C12-C13	-2.76	115.08	119.57
5	I	404	EPE	C5-N4-C3	2.73	114.97	108.83
4	L	403	QKQ	C5-C6-C20	-2.71	118.58	122.20
5	D	404	EPE	C5-C6-N1	-2.66	105.18	110.64
5	D	404	EPE	C7-N4-C5	2.59	117.87	111.23
5	J	404	EPE	C7-N4-C5	2.58	117.84	111.23
4	H	403	QKQ	C5-C6-C20	-2.57	118.76	122.20
4	B	403	QKQ	C5-C6-C20	-2.55	118.79	122.20
5	E	404	EPE	C5-C6-N1	-2.54	105.44	110.64
4	A	403	QKQ	C11-C12-N5	2.51	126.51	123.42
5	J	404	EPE	C5-N4-C3	2.50	114.46	108.83
5	G	404	EPE	C5-N4-C3	2.48	114.41	108.83
5	B	404	EPE	C7-N4-C3	2.48	117.57	111.23
5	K	404	EPE	C5-N4-C3	2.47	114.39	108.83
5	F	404	EPE	C7-N4-C5	2.47	117.55	111.23
4	C	403	QKQ	C5-C6-C20	-2.47	118.91	122.20
4	D	403	QKQ	C6-C20-C9	-2.45	117.84	119.23
4	A	403	QKQ	C5-C6-C20	2.45	125.48	122.20
5	B	404	EPE	O1S-S-C10	2.42	109.83	106.92
5	F	404	EPE	C3-C2-N1	-2.39	105.73	110.64
5	G	404	EPE	C7-N4-C5	2.39	117.35	111.23
5	B	404	EPE	C5-N4-C3	2.36	114.14	108.83
5	L	404	EPE	C5-N4-C3	2.36	114.13	108.83
4	C	403	QKQ	C7-C6-C5	2.33	122.97	119.61
5	B	404	EPE	C5-C6-N1	-2.32	105.88	110.64
5	J	404	EPE	C3-C2-N1	-2.32	105.89	110.64
5	E	404	EPE	C5-N4-C3	2.31	114.02	108.83
5	I	404	EPE	C7-N4-C5	2.29	117.08	111.23
5	I	404	EPE	O2S-S-C10	2.27	109.65	106.92
5	F	404	EPE	C5-N4-C3	2.27	113.93	108.83
4	J	403	QKQ	C8-N1-C7	2.27	118.79	116.87
5	J	404	EPE	C5-C6-N1	-2.25	106.03	110.64
5	K	404	EPE	C7-N4-C5	2.24	116.97	111.23

*Continued on next page...*

*Continued from previous page...*

Mol	Chain	Res	Type	Atoms	Z	Observed(°)	Ideal(°)
5	A	404	EPE	C3-C2-N1	-2.20	106.12	110.64
5	I	404	EPE	C7-N4-C3	2.20	116.86	111.23
5	B	404	EPE	C7-N4-C5	2.20	116.85	111.23
5	D	404	EPE	C5-N4-C3	2.19	113.76	108.83
5	H	404	EPE	O1S-S-C10	2.19	109.55	106.92
5	A	404	EPE	C7-N4-C5	2.19	116.82	111.23
5	H	404	EPE	C5-N4-C3	2.17	113.72	108.83
4	K	403	QKQ	C8-N1-C7	2.17	118.71	116.87
4	A	403	QKQ	C7-C6-C5	-2.15	116.51	119.61
4	G	403	QKQ	C6-C20-C9	-2.12	118.03	119.23
5	C	404	EPE	O3S-S-C10	2.10	109.17	105.77
4	L	403	QKQ	C11-C10-C9	-2.10	117.57	120.82
5	E	404	EPE	C7-N4-C5	2.10	116.59	111.23
5	H	404	EPE	C7-N4-C5	2.09	116.59	111.23
5	C	404	EPE	C9-N1-C6	2.02	116.41	111.23
5	G	404	EPE	O2S-S-O1S	-2.02	106.94	113.95
5	L	404	EPE	C5-C6-N1	-2.00	106.53	110.64

There are no chirality outliers.

All (66) torsion outliers are listed below:

Mol	Chain	Res	Type	Atoms
4	G	403	QKQ	C14-C15-C16-N3
5	B	404	EPE	S-C10-C9-N1
5	E	404	EPE	S-C10-C9-N1
4	D	403	QKQ	C14-C15-C16-N3
4	A	403	QKQ	C12-C13-N2-C14
5	C	404	EPE	S-C10-C9-N1
4	K	403	QKQ	C12-C13-N2-C14
4	F	403	QKQ	C14-C15-C16-N3
5	G	404	EPE	S-C10-C9-N1
5	L	404	EPE	S-C10-C9-N1
5	H	404	EPE	S-C10-C9-N1
5	A	404	EPE	S-C10-C9-N1
5	I	404	EPE	C8-C7-N4-C5
5	I	404	EPE	S-C10-C9-N1
5	K	404	EPE	S-C10-C9-N1
5	J	404	EPE	S-C10-C9-N1
5	D	404	EPE	S-C10-C9-N1
5	F	404	EPE	S-C10-C9-N1
4	A	403	QKQ	O2-C13-N2-C14
4	K	403	QKQ	C22-C2-O1-C1

*Continued on next page...*



*Continued from previous page...*

Mol	Chain	Res	Type	Atoms
4	K	403	QKQ	O2-C13-N2-C14
4	A	403	QKQ	C22-C2-O1-C1
4	A	403	QKQ	C3-C2-O1-C1
4	K	403	QKQ	C3-C2-O1-C1
4	A	403	QKQ	C15-C14-N2-C13
4	I	403	QKQ	C3-C2-O1-C1
4	I	403	QKQ	C22-C2-O1-C1
4	D	403	QKQ	N2-C14-C15-C16
4	A	403	QKQ	N2-C14-C15-C16
5	B	404	EPE	C8-C7-N4-C5
5	L	404	EPE	C8-C7-N4-C5
4	E	403	QKQ	C12-C13-N2-C14
4	G	403	QKQ	C12-C13-N2-C14
4	G	403	QKQ	O2-C13-N2-C14
5	J	404	EPE	C8-C7-N4-C5
4	E	403	QKQ	O2-C13-N2-C14
4	H	403	QKQ	N2-C14-C15-C16
5	K	404	EPE	C8-C7-N4-C5
5	A	404	EPE	C8-C7-N4-C5
4	D	403	QKQ	C15-C16-N3-C19
4	B	403	QKQ	C3-C2-O1-C1
4	B	403	QKQ	C22-C2-O1-C1
4	C	403	QKQ	N2-C14-C15-C16
5	G	404	EPE	C8-C7-N4-C5
4	C	403	QKQ	C3-C2-O1-C1
4	I	403	QKQ	C15-C16-N3-C19
4	B	403	QKQ	C15-C16-N3-C19
4	E	403	QKQ	N2-C14-C15-C16
4	C	403	QKQ	C22-C2-O1-C1
4	D	403	QKQ	C15-C16-N3-C17
4	F	403	QKQ	C15-C16-N3-C17
5	F	404	EPE	C8-C7-N4-C5
4	B	403	QKQ	N5-C12-C13-O2
4	E	403	QKQ	C22-C2-O1-C1
5	E	404	EPE	N4-C7-C8-O8
4	F	403	QKQ	C15-C16-N3-C19
4	A	403	QKQ	C15-C16-N3-C17
4	I	403	QKQ	C15-C16-N3-C17
4	K	403	QKQ	C14-C15-C16-N3
4	A	403	QKQ	C21-C5-C6-C20
5	G	404	EPE	N4-C7-C8-O8
4	B	403	QKQ	N5-C12-C13-N2

*Continued on next page...*

*Continued from previous page...*

Mol	Chain	Res	Type	Atoms
5	K	404	EPE	N4-C7-C8-O8
5	E	404	EPE	C8-C7-N4-C5
5	D	404	EPE	C8-C7-N4-C5
4	E	403	QKQ	C3-C2-O1-C1

There are no ring outliers.

20 monomers are involved in 101 short contacts:

Mol	Chain	Res	Type	Clashes	Symm-Clashes
4	G	403	QKQ	6	0
4	A	403	QKQ	15	0
4	E	403	QKQ	7	0
5	B	404	EPE	1	0
5	E	404	EPE	1	0
4	H	403	QKQ	3	0
4	L	403	QKQ	5	0
4	C	403	QKQ	6	0
4	D	403	QKQ	6	0
3	L	402	FES	2	0
5	G	404	EPE	1	0
4	K	403	QKQ	16	0
4	F	403	QKQ	8	0
4	I	403	QKQ	2	0
4	B	403	QKQ	13	0
5	L	404	EPE	2	0
4	J	403	QKQ	3	0
3	A	402	FES	1	0
5	I	404	EPE	1	0
5	F	404	EPE	2	0

The following is a two-dimensional graphical depiction of Mogul quality analysis of bond lengths, bond angles, torsion angles, and ring geometry for all instances of the Ligand of Interest. In addition, ligands with molecular weight > 250 and outliers as shown on the validation Tables will also be included. For torsion angles, if less than 5% of the Mogul distribution of torsion angles is within 10 degrees of the torsion angle in question, then that torsion angle is considered an outlier. Any bond that is central to one or more torsion angles identified as an outlier by Mogul will be highlighted in the graph. For rings, the root-mean-square deviation (RMSD) between the ring in question and similar rings identified by Mogul is calculated over all ring torsion angles. If the average RMSD is greater than 60 degrees and the minimal RMSD between the ring in question and any Mogul-identified rings is also greater than 60 degrees, then that ring is considered an outlier. The outliers are highlighted in purple. The color gray indicates Mogul did not find sufficient equivalents in the CSD to analyse the geometry.

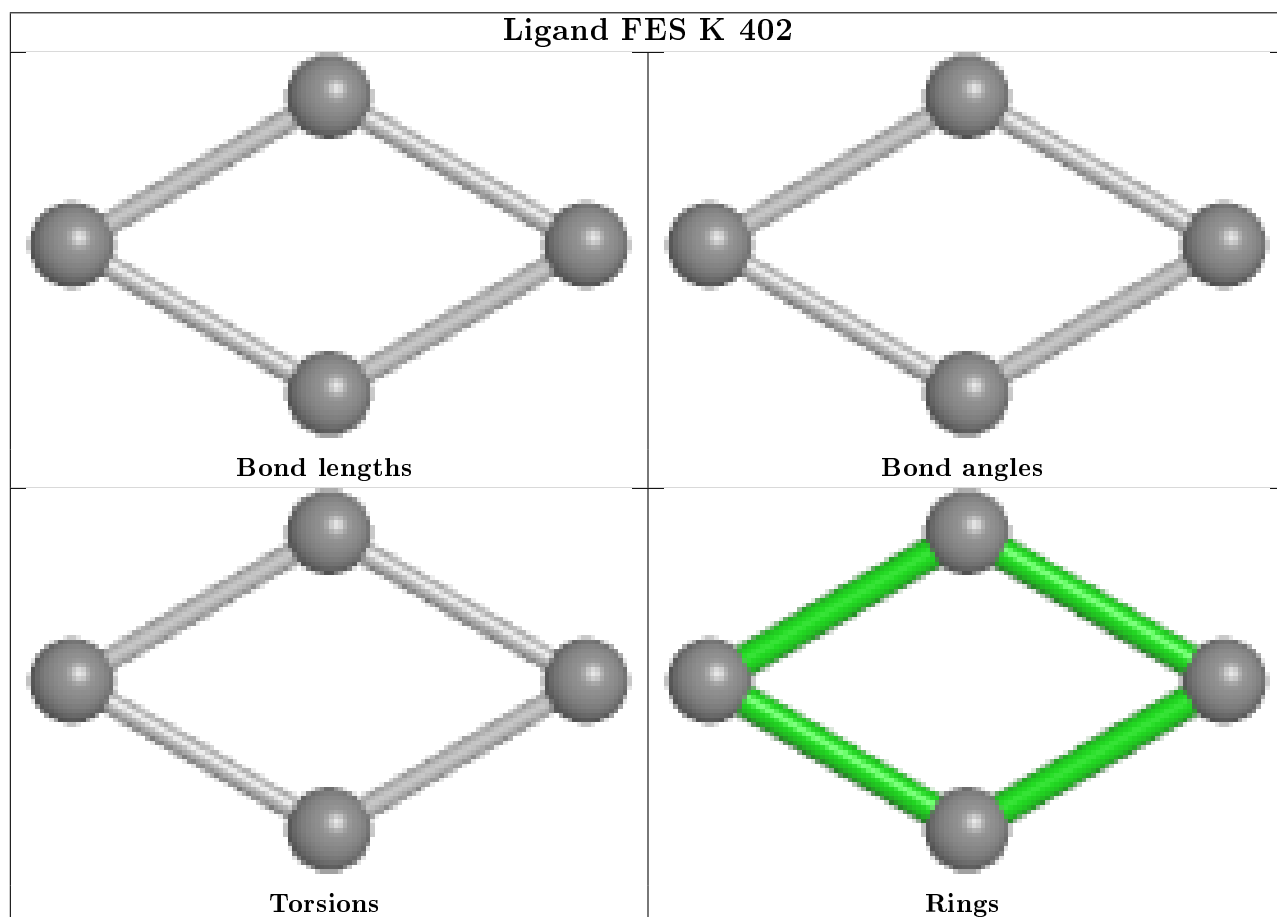
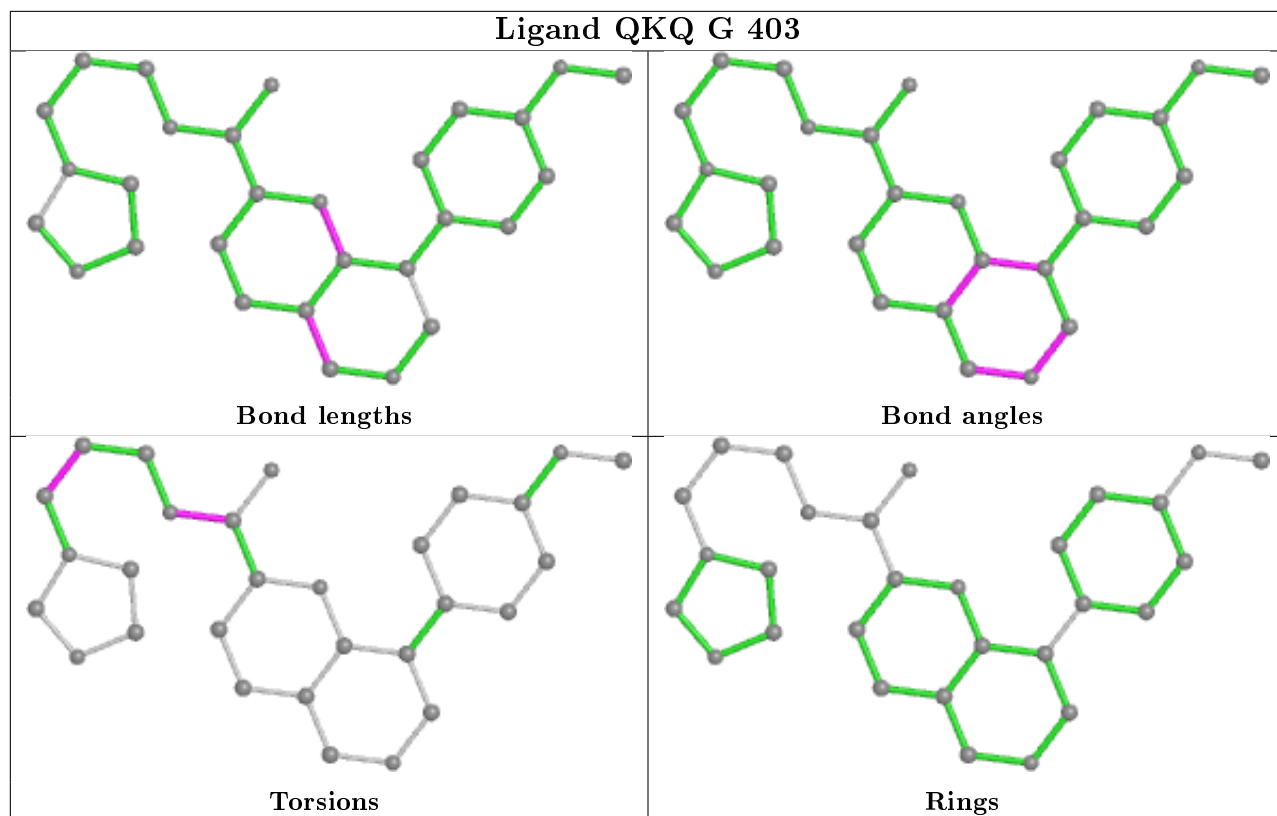

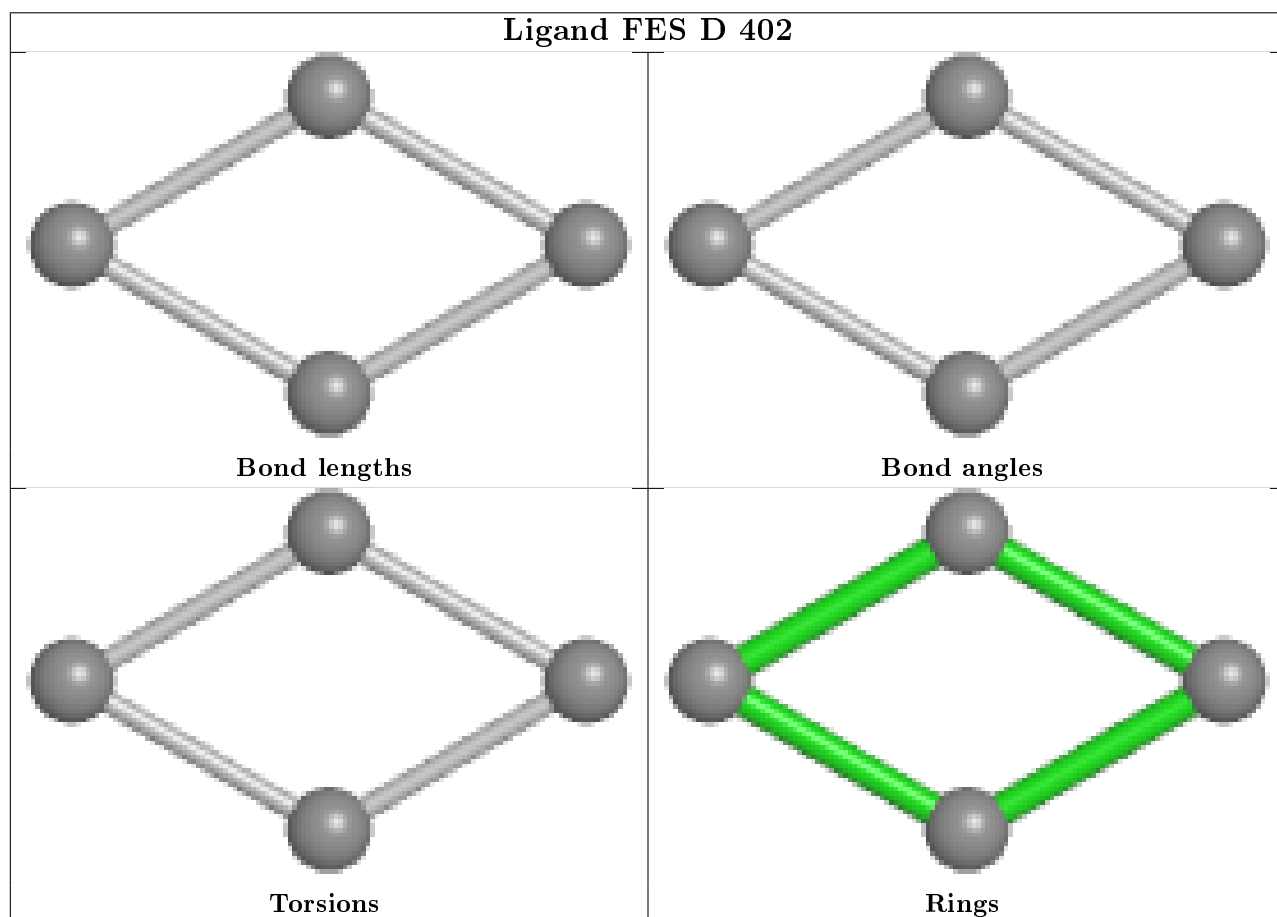
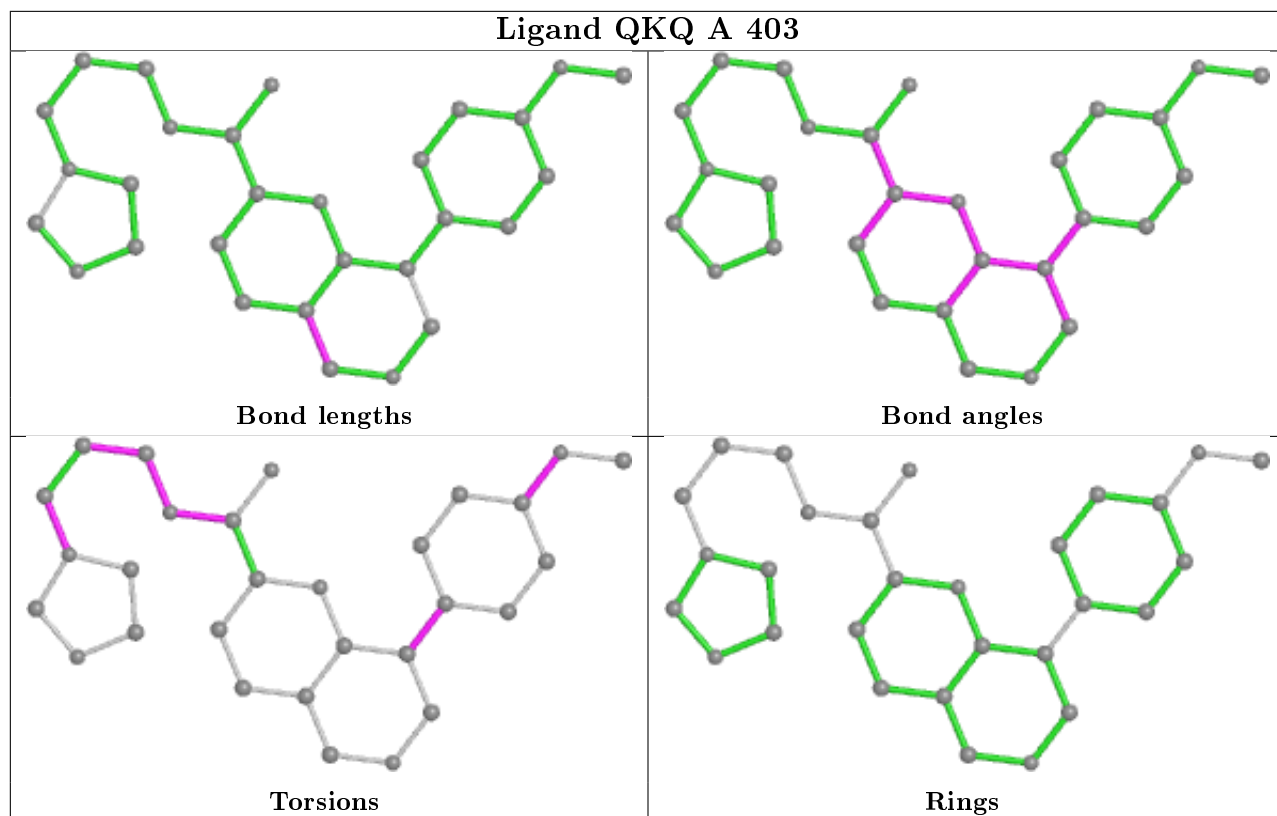

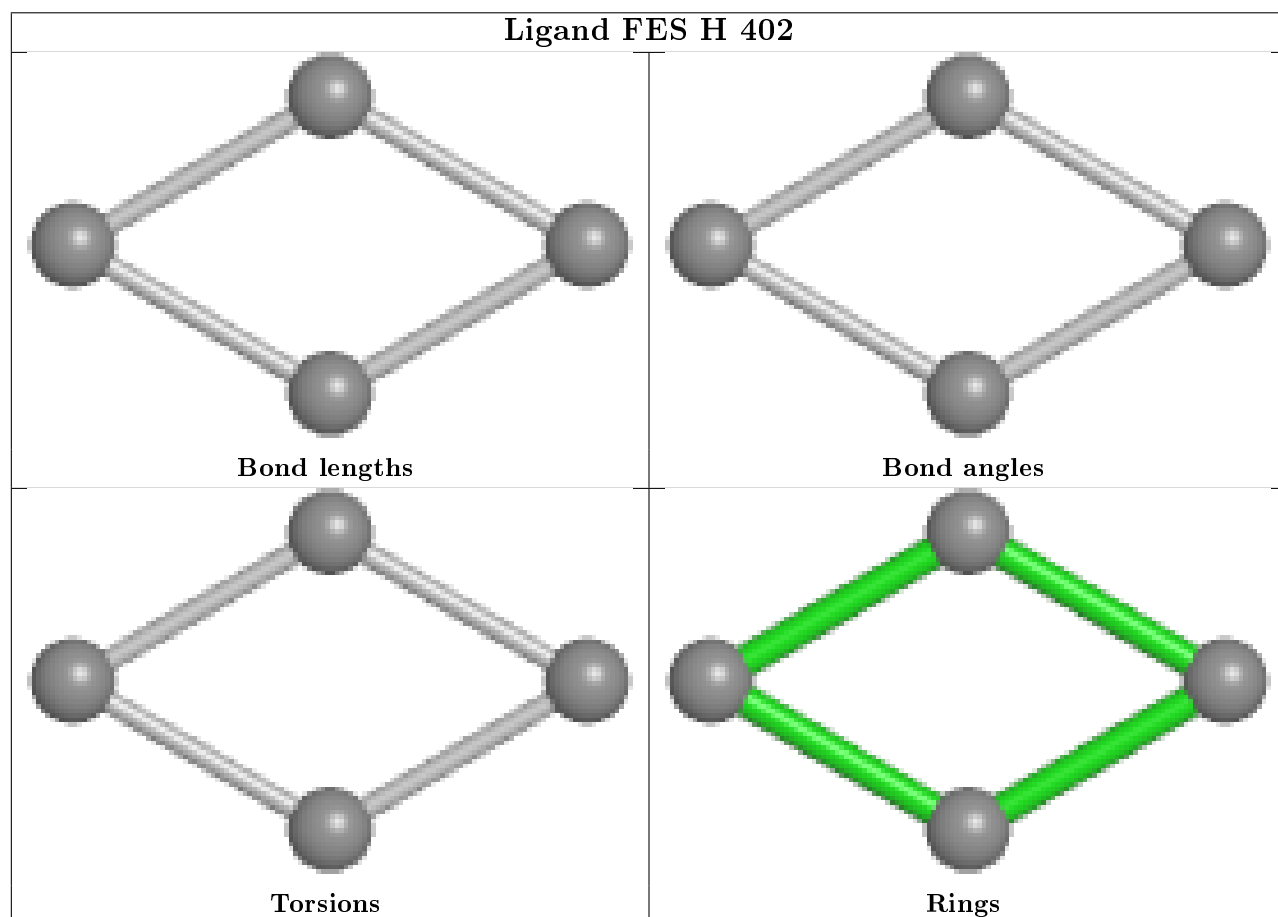
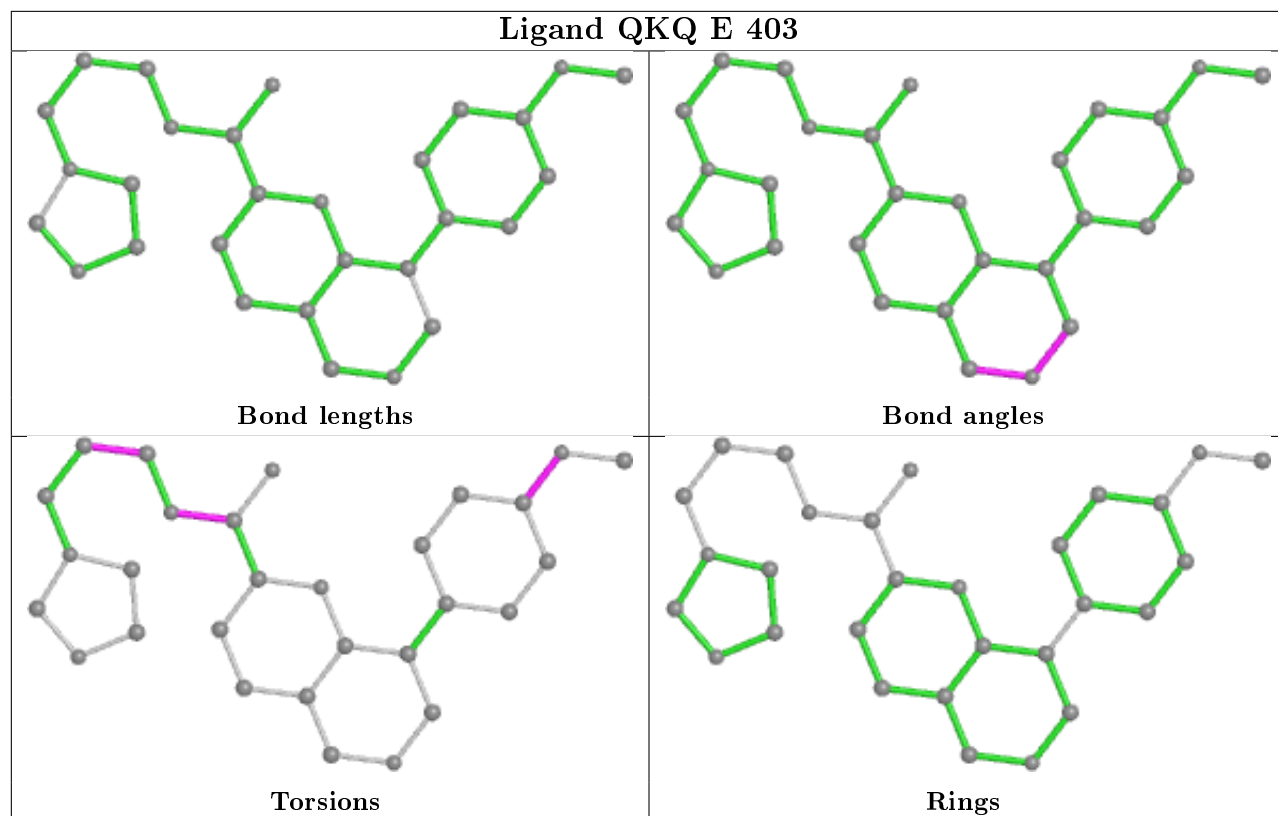

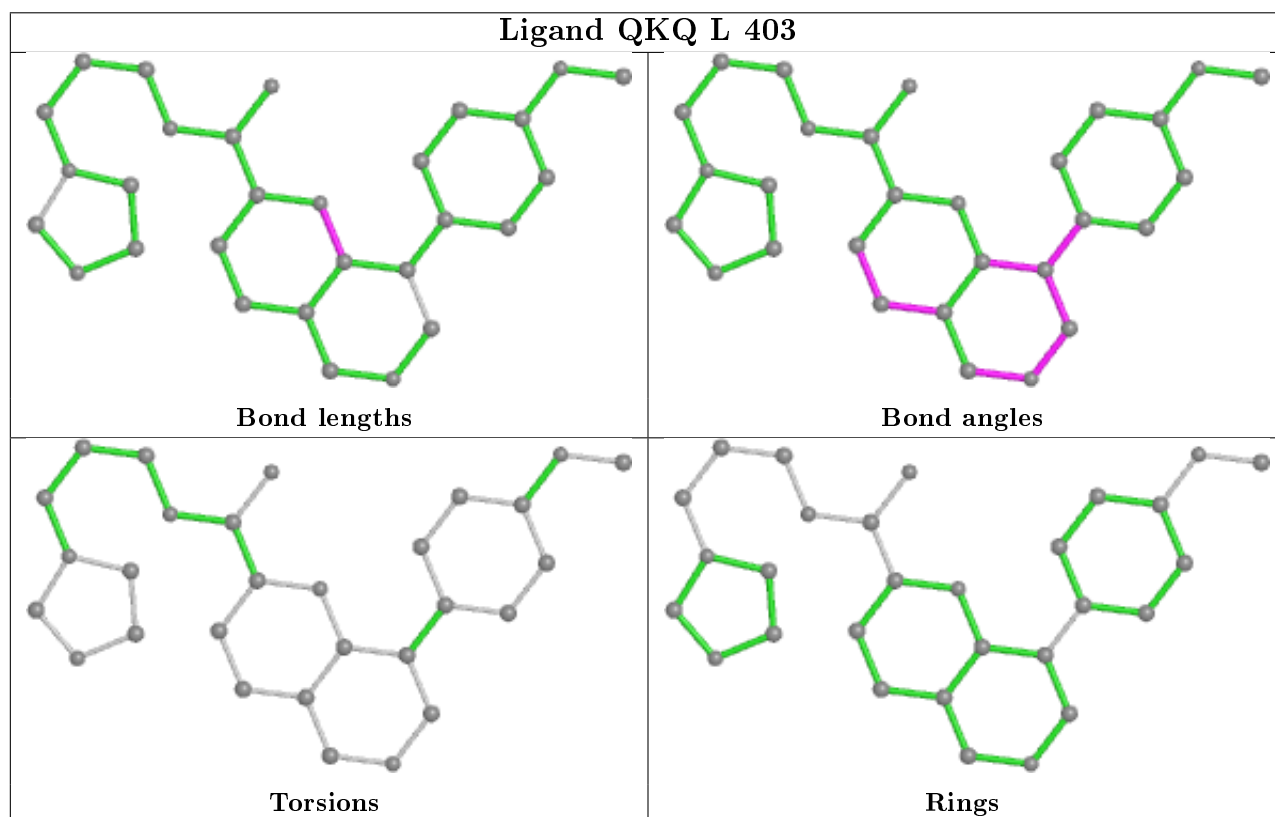
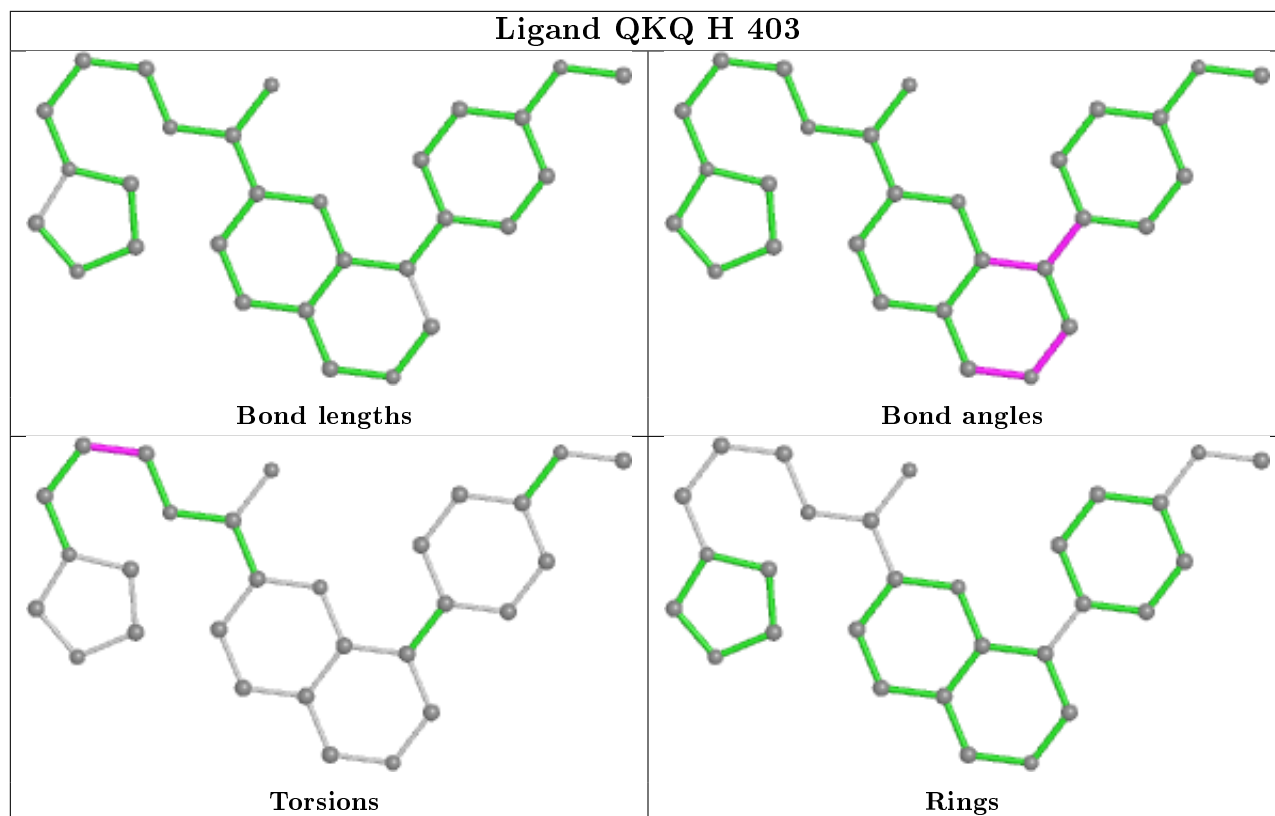

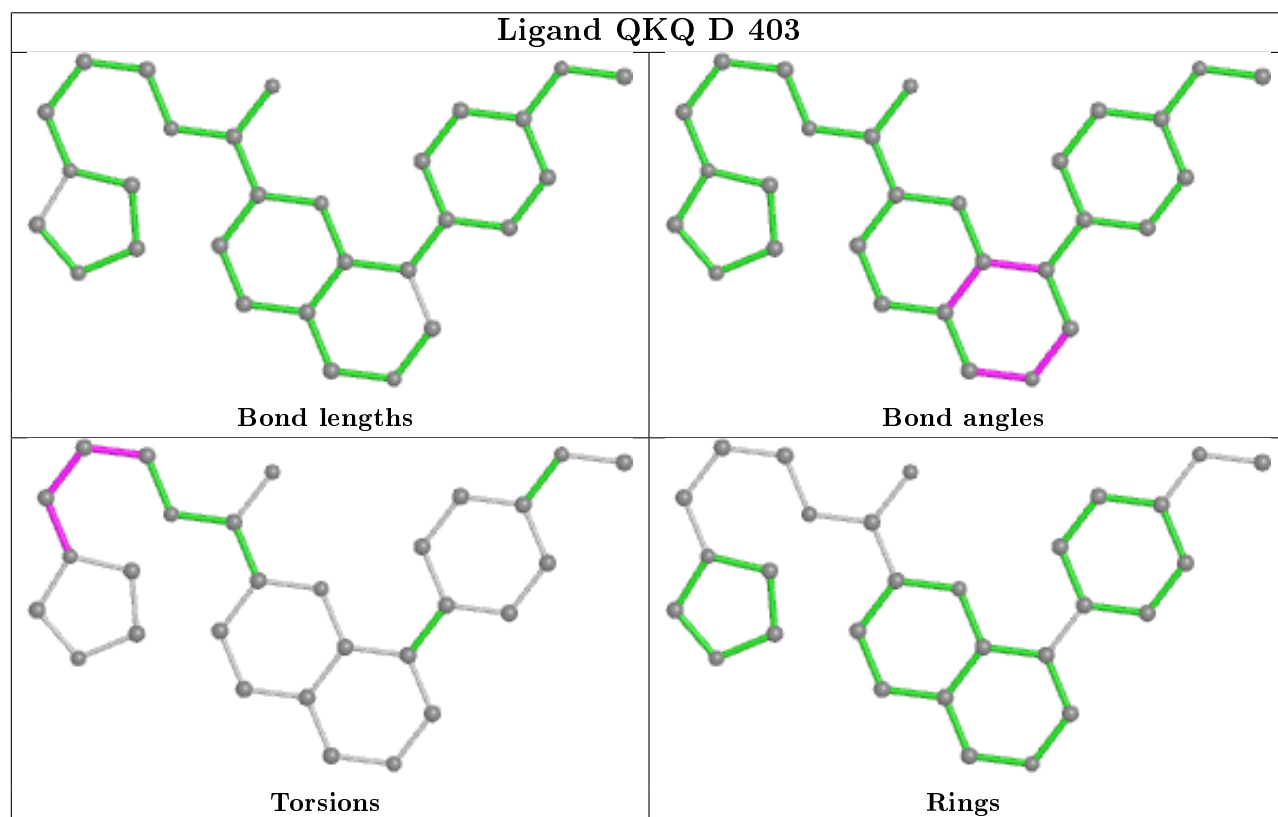
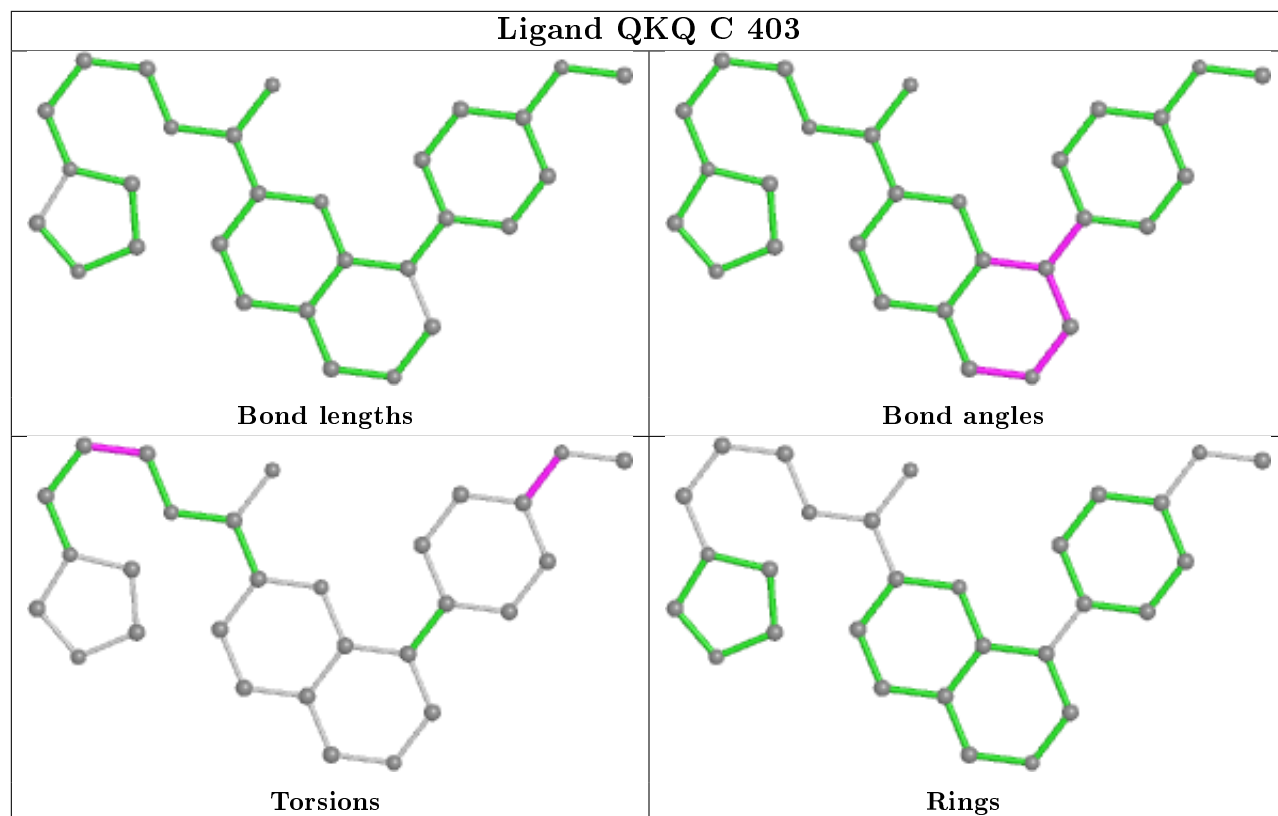

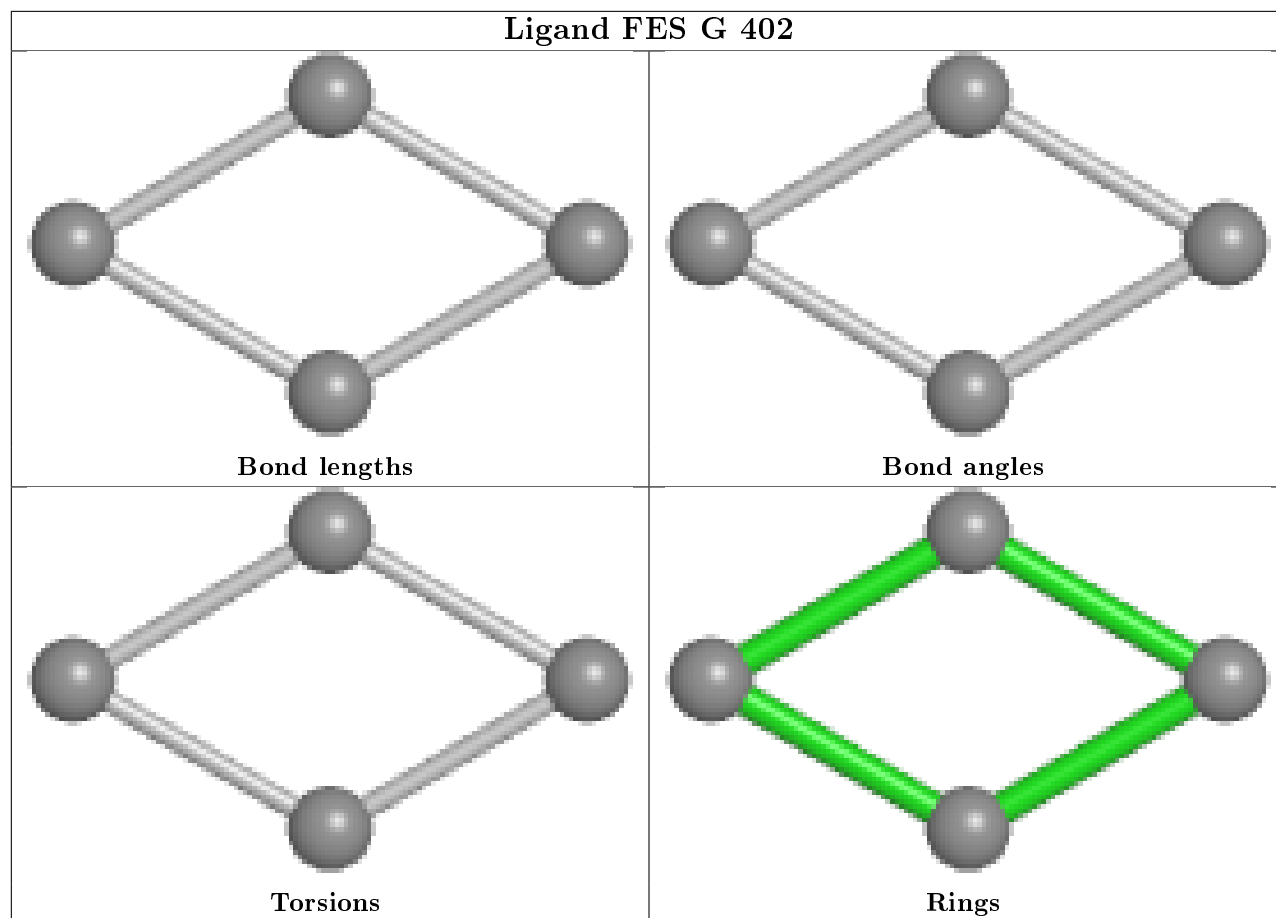



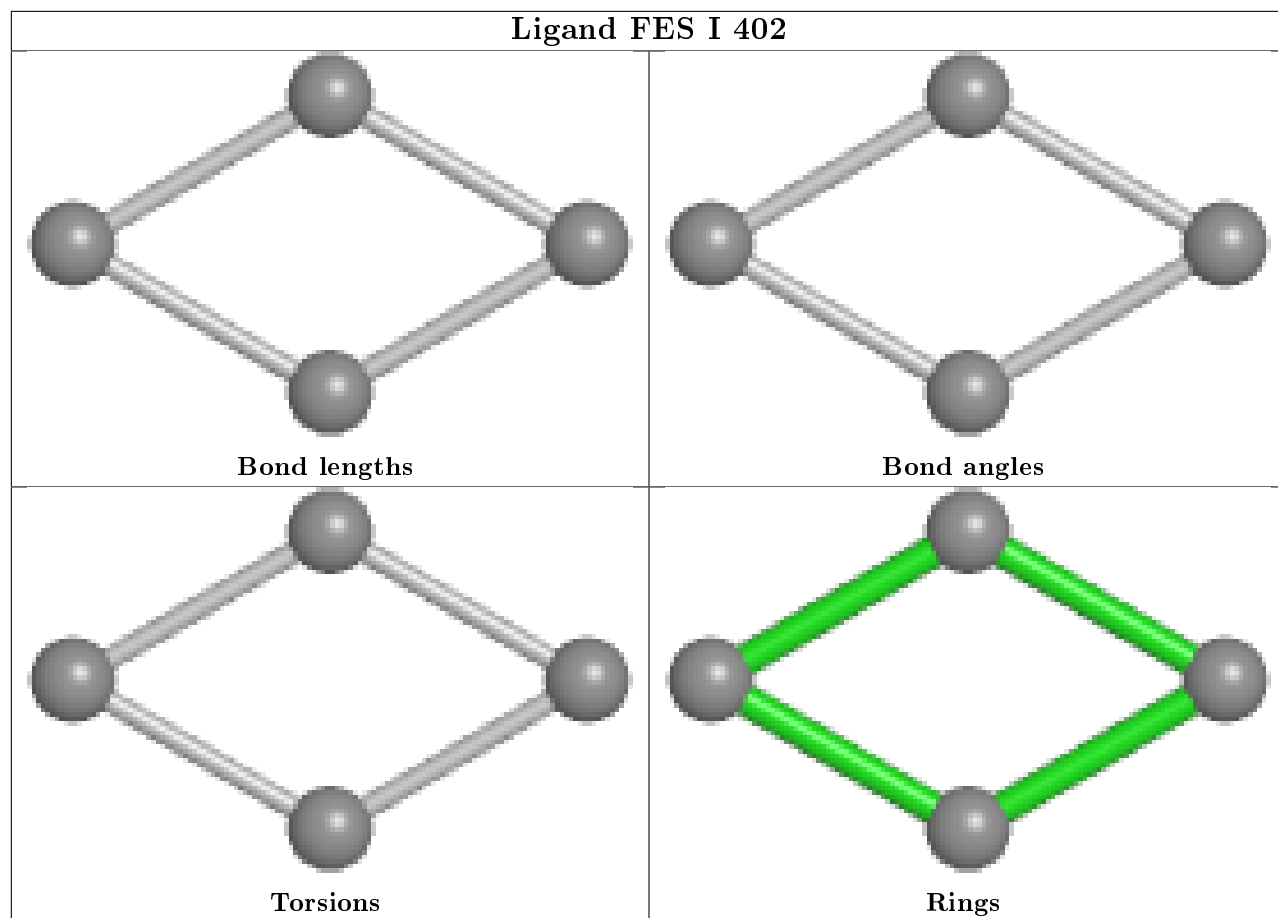

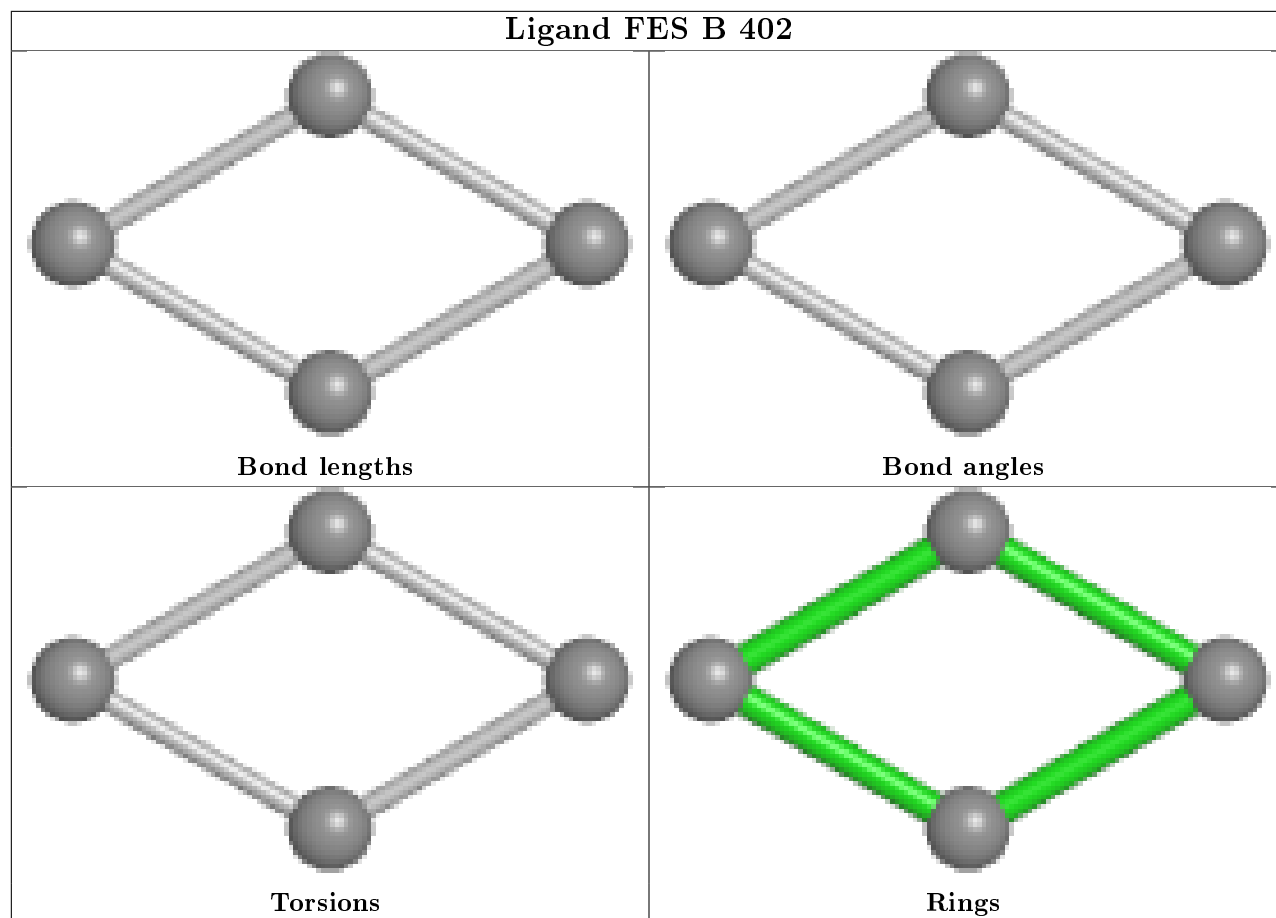

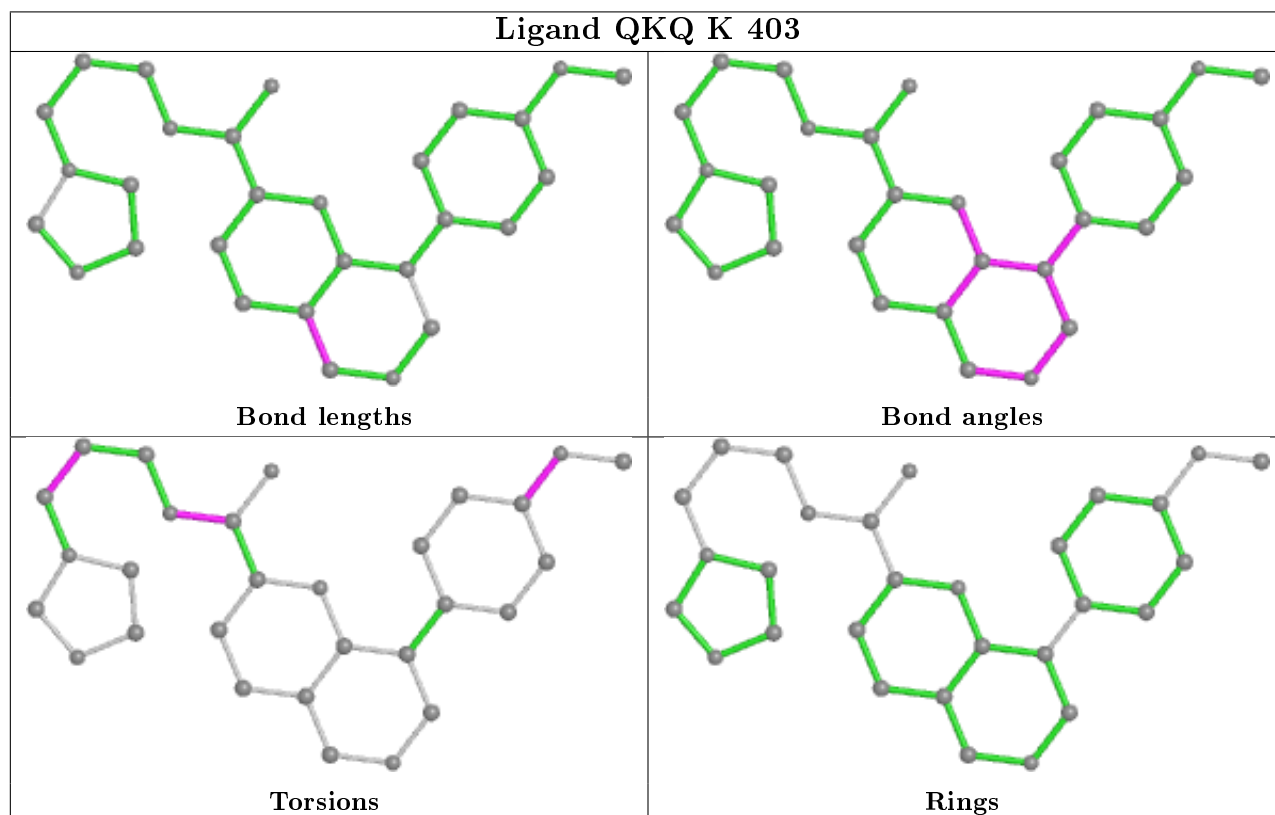
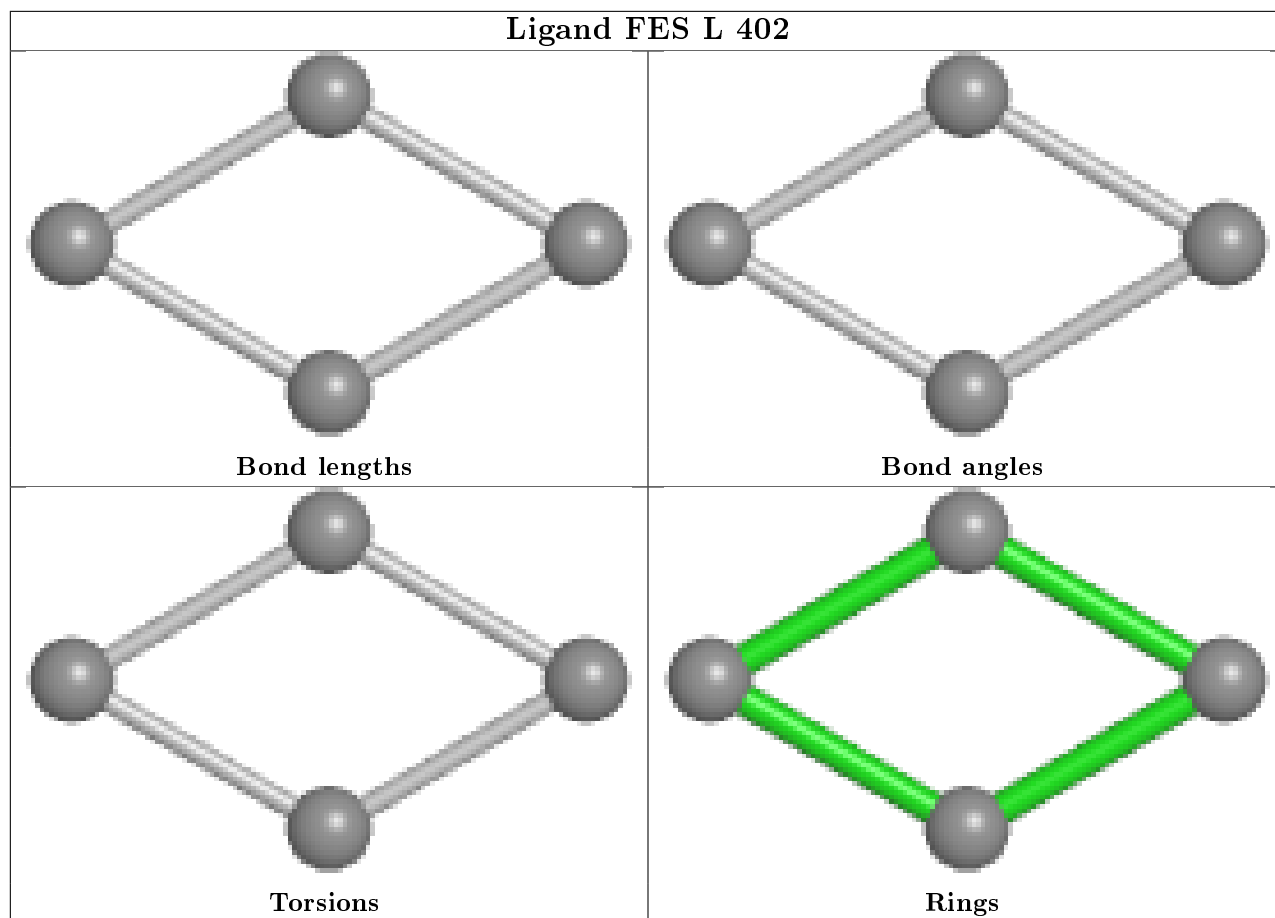

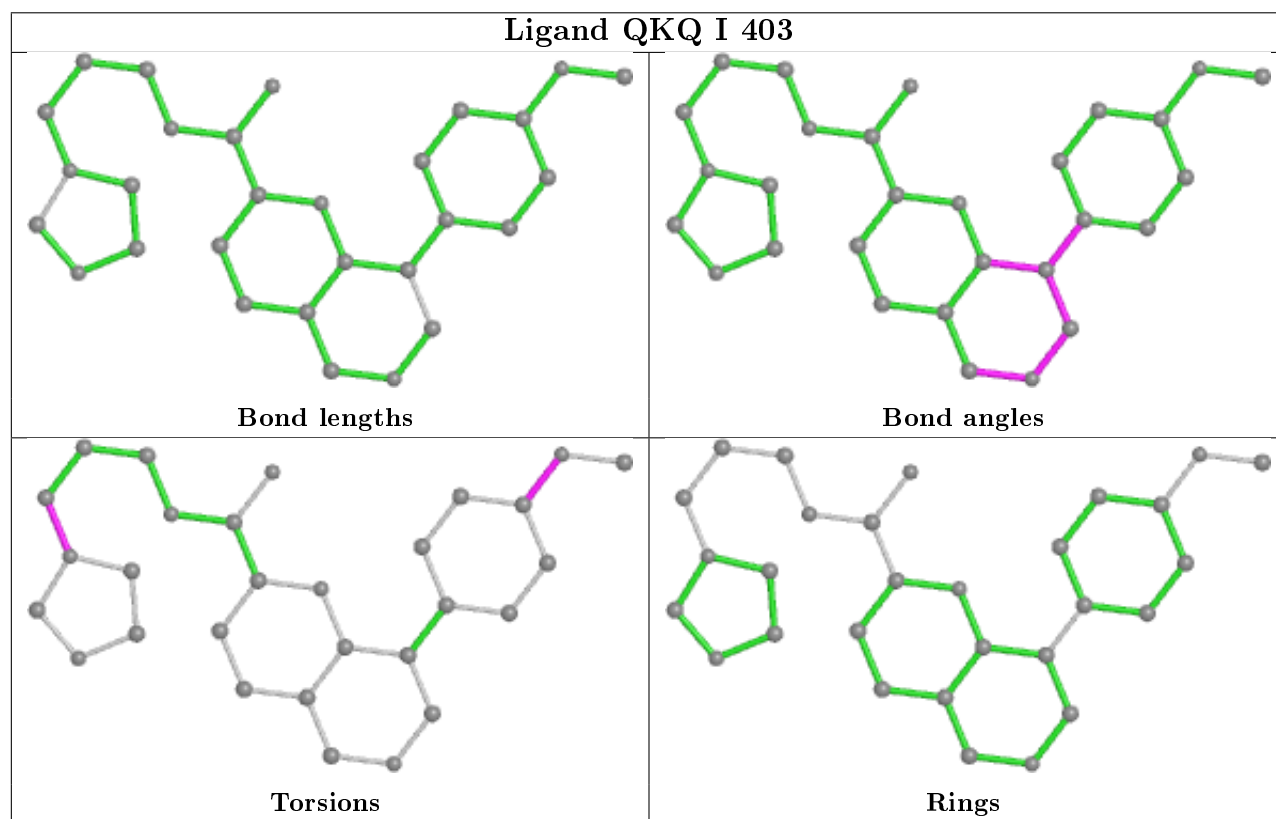
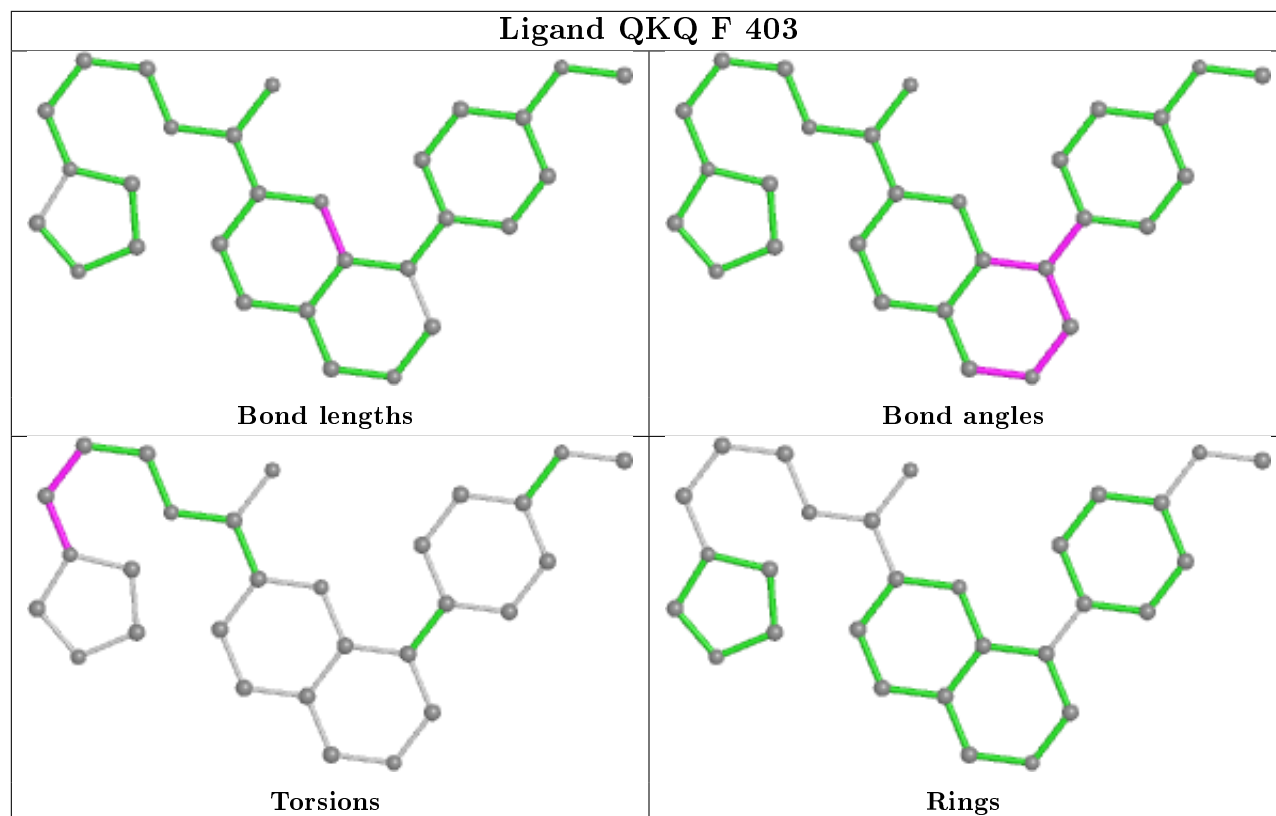

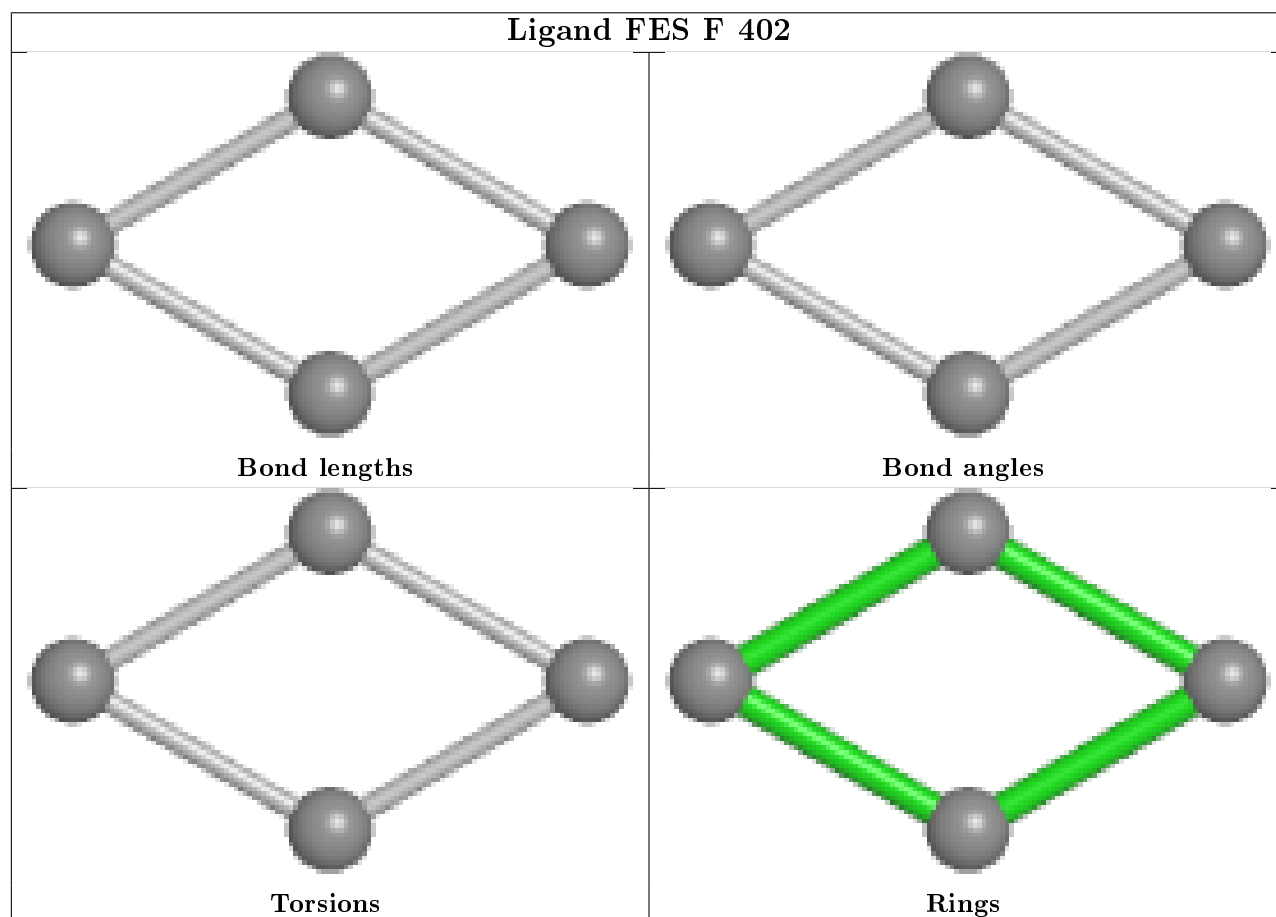
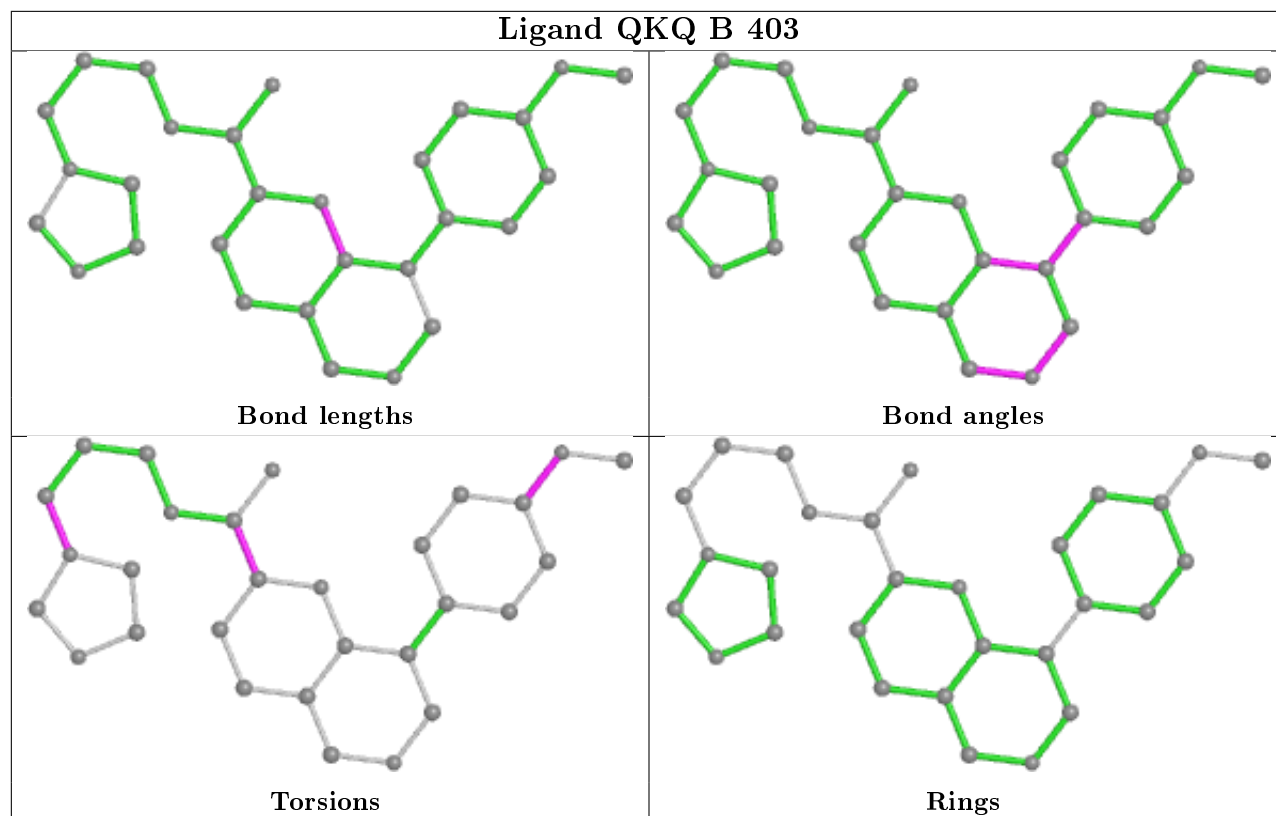

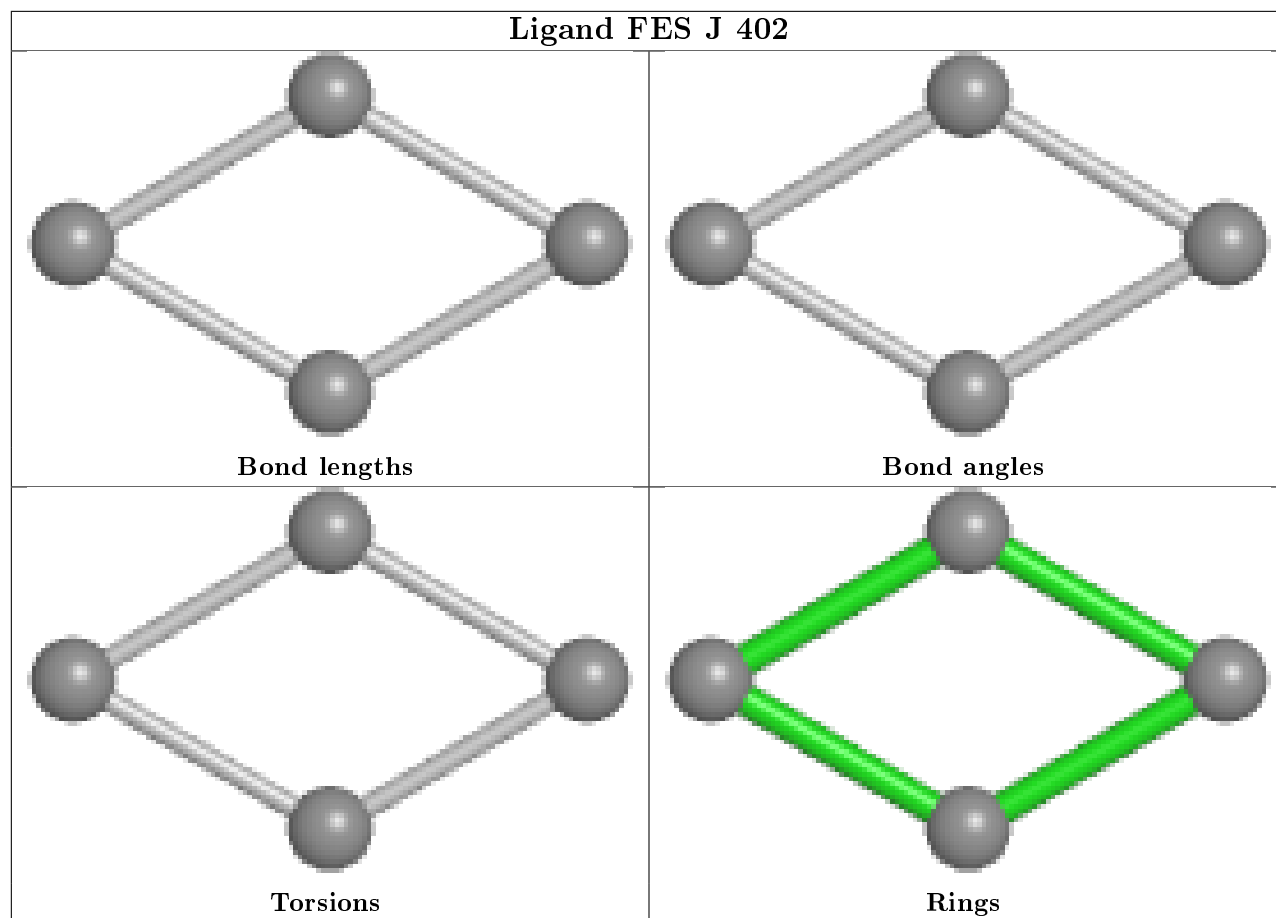

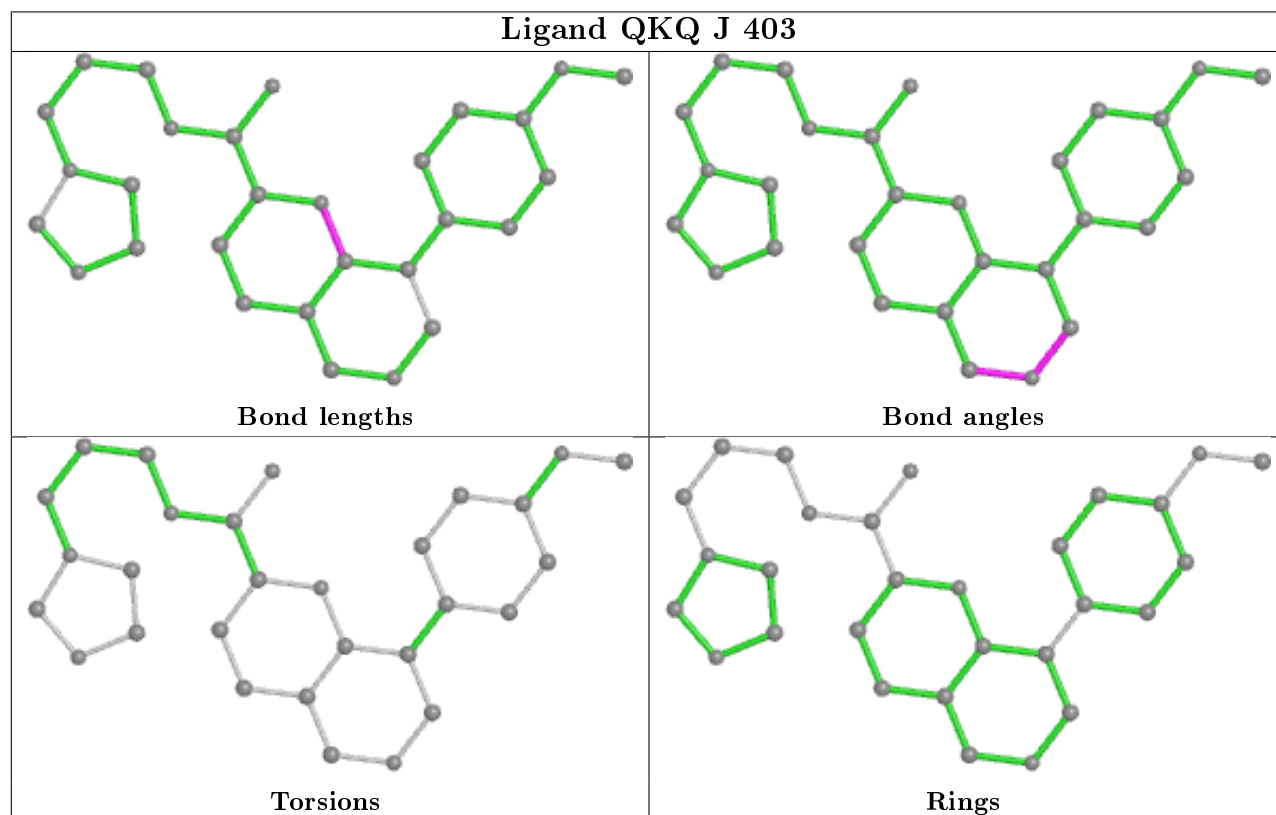
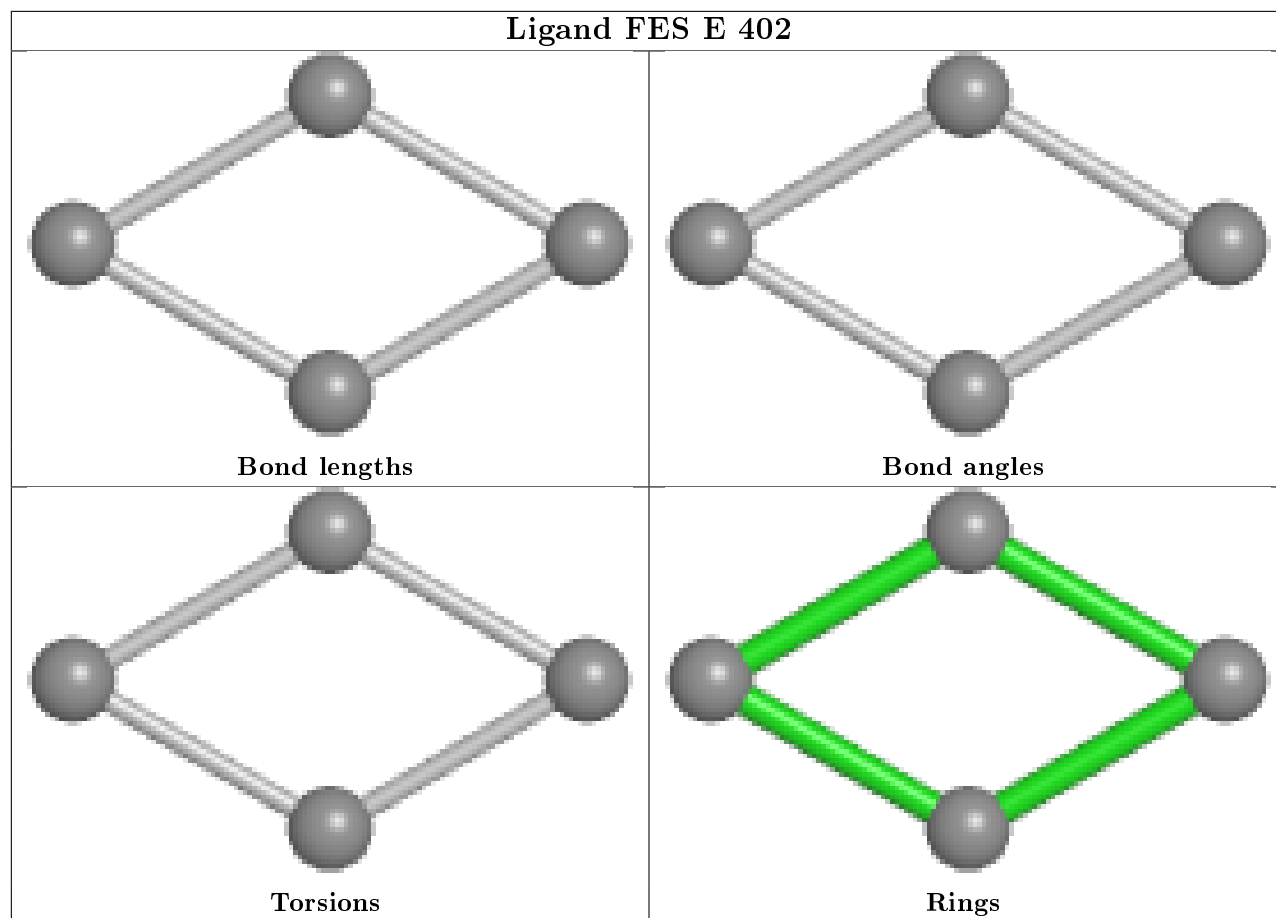

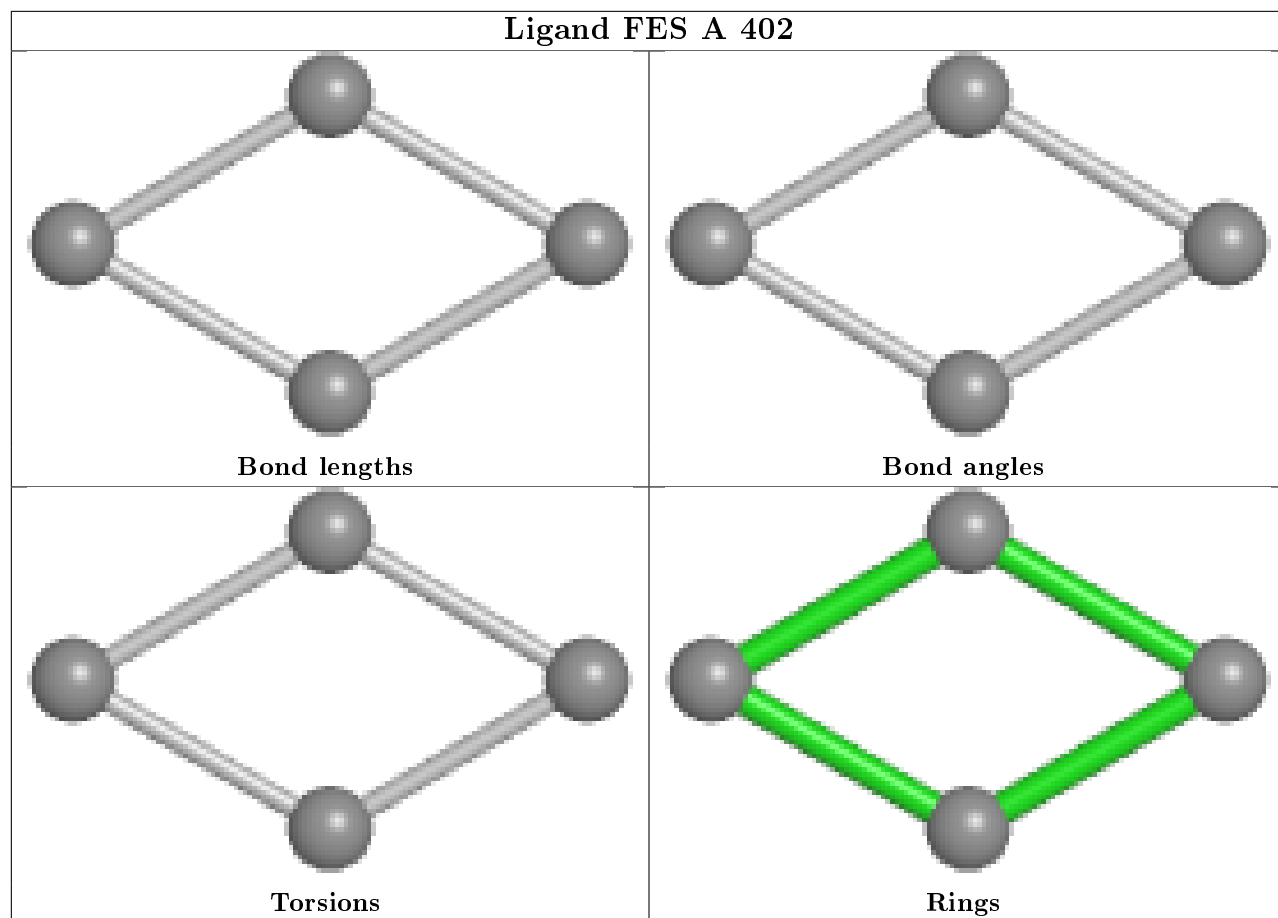



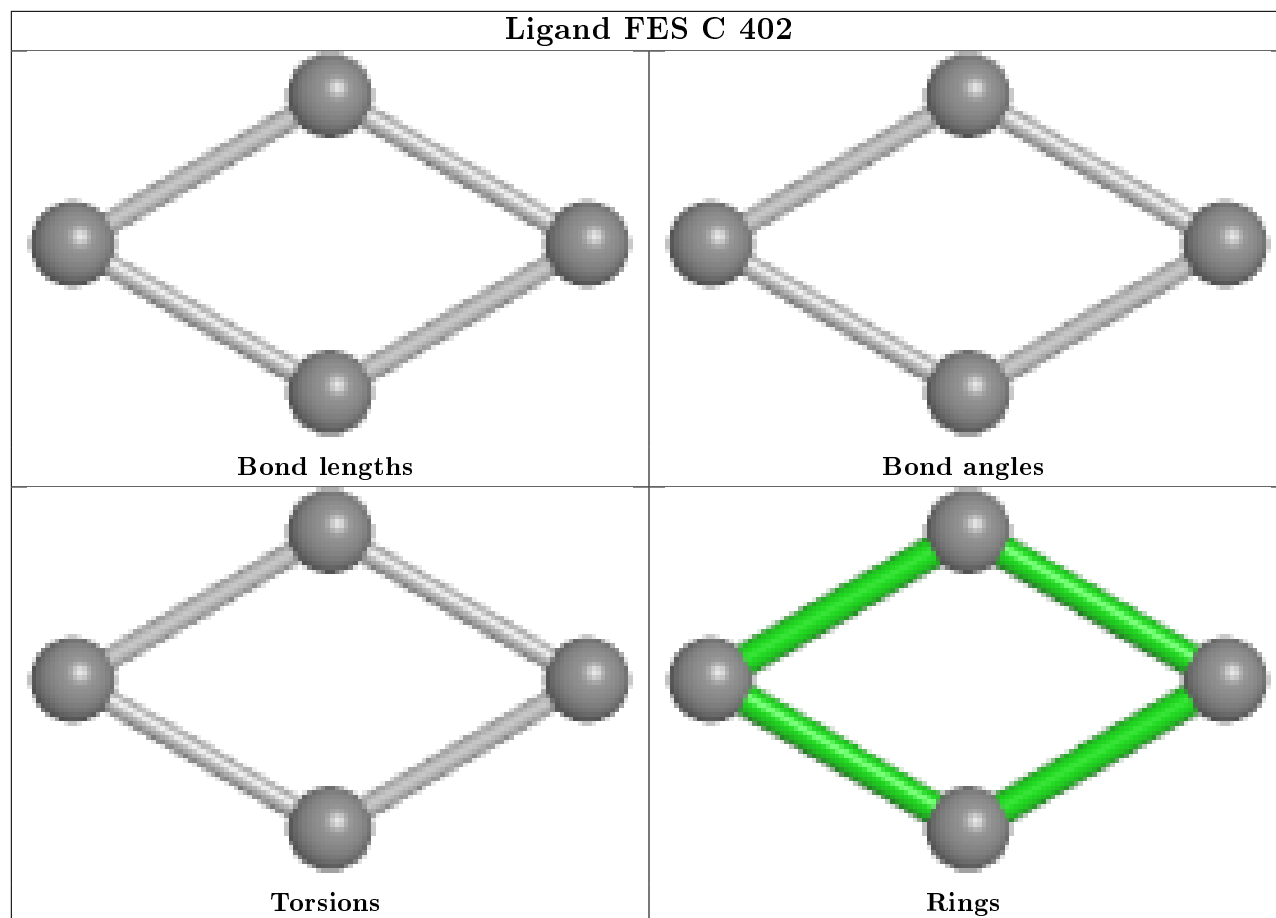

## 5.7 Other polymers [i](#)

There are no such residues in this entry.

## 5.8 Polymer linkage issues [i](#)

There are no chain breaks in this entry.

## 6 Fit of model and data

### 6.1 Protein, DNA and RNA chains

In the following table, the column labelled ‘#RSRZ> 2’ contains the number (and percentage) of RSRZ outliers, followed by percent RSRZ outliers for the chain as percentile scores relative to all X-ray entries and entries of similar resolution. The OWAB column contains the minimum, median, 95<sup>th</sup> percentile and maximum values of the occupancy-weighted average B-factor per residue. The column labelled ‘Q< 0.9’ lists the number of (and percentage) of residues with an average occupancy less than 0.9.

Mol	Chain	Analysed	<RSRZ>	#RSRZ>2	OWAB(Å <sup>2</sup> )	Q<0.9
1	A	360/391 (92%)	0.71	30 (8%) 11 10	29, 52, 103, 176	0
1	B	357/391 (91%)	0.58	29 (8%) 12 11	29, 48, 93, 153	0
1	C	357/391 (91%)	0.61	22 (6%) 20 19	34, 52, 94, 150	0
1	D	360/391 (92%)	0.51	22 (6%) 21 20	27, 45, 99, 154	0
1	E	360/391 (92%)	0.48	21 (5%) 23 22	31, 46, 102, 158	0
1	F	359/391 (91%)	0.46	16 (4%) 33 32	25, 39, 83, 138	0
1	G	363/391 (92%)	0.45	20 (5%) 25 24	24, 39, 81, 156	0
1	H	358/391 (91%)	0.42	17 (4%) 31 30	24, 39, 88, 142	0
1	I	358/391 (91%)	0.55	28 (7%) 13 12	23, 41, 85, 156	0
1	J	356/391 (91%)	0.51	27 (7%) 13 13	25, 42, 84, 130	0
1	K	359/391 (91%)	0.86	43 (11%) 4 3	31, 55, 108, 164	0
1	L	358/391 (91%)	0.52	29 (8%) 12 11	29, 45, 90, 150	0
All	All	4305/4692 (91%)	0.56	304 (7%) 16 15	23, 45, 95, 176	0

All (304) RSRZ outliers are listed below:

Mol	Chain	Res	Type	RSRZ
1	D	253	VAL	16.9
1	A	253	VAL	15.1
1	E	254	THR	12.5
1	A	215	GLY	11.1
1	C	242	SER	10.9
1	K	217	ALA	10.3
1	K	242	SER	10.3
1	A	219	SER	9.5
1	G	244	GLU	9.2
1	B	220	VAL	9.1
1	K	254	THR	9.1

*Continued on next page...*

*Continued from previous page...*

<b>Mol</b>	<b>Chain</b>	<b>Res</b>	<b>Type</b>	<b>RSRZ</b>
1	F	253	VAL	8.7
1	D	3	ALA	8.3
1	K	215	GLY	8.3
1	G	219	SER	8.3
1	I	216	PHE	8.0
1	G	243	SER	7.9
1	B	217	ALA	7.8
1	J	217	ALA	7.7
1	B	243	SER	7.7
1	D	217	ALA	7.6
1	E	253	VAL	7.6
1	A	254	THR	7.3
1	L	3	ALA	7.3
1	A	216	PHE	7.3
1	I	220	VAL	7.2
1	J	223	ASP	7.2
1	K	220	VAL	7.1
1	I	217	ALA	7.1
1	E	218	ASP	7.1
1	F	241	ARG	7.1
1	K	243	SER	7.0
1	F	254	THR	6.8
1	A	255	ASP	6.8
1	J	218	ASP	6.7
1	D	255	ASP	6.7
1	G	247	PHE	6.6
1	C	3	ALA	6.6
1	L	216	PHE	6.5
1	E	255	ASP	6.5
1	F	3	ALA	6.4
1	K	258	PHE	6.4
1	K	255	ASP	6.4
1	G	246	SER	6.4
1	G	245	LYS	6.3
1	K	241	ARG	6.2
1	C	215	GLY	6.2
1	E	214	PRO	6.1
1	D	220	VAL	6.1
1	H	216	PHE	6.0
1	F	219	SER	5.9
1	F	223	ASP	5.7
1	F	220	VAL	5.7

*Continued on next page...*

*Continued from previous page...*

<b>Mol</b>	<b>Chain</b>	<b>Res</b>	<b>Type</b>	<b>RSRZ</b>
1	A	212	ALA	5.6
1	J	254	THR	5.6
1	B	219	SER	5.5
1	K	222	VAL	5.4
1	J	225	TYR	5.4
1	C	121	LEU	5.4
1	L	217	ALA	5.3
1	J	216	PHE	5.2
1	K	277	PHE	5.2
1	E	223	ASP	5.2
1	F	216	PHE	5.1
1	D	216	PHE	5.1
1	K	216	PHE	5.1
1	C	223	ASP	5.1
1	I	243	SER	5.0
1	D	254	THR	5.0
1	K	212	ALA	4.9
1	D	215	GLY	4.9
1	I	214	PRO	4.9
1	A	242	SER	4.8
1	H	219	SER	4.8
1	I	218	ASP	4.8
1	L	254	THR	4.8
1	J	255	ASP	4.8
1	C	216	PHE	4.7
1	K	223	ASP	4.7
1	K	211	PRO	4.7
1	L	255	ASP	4.6
1	C	241	ARG	4.6
1	G	217	ALA	4.6
1	A	258	PHE	4.6
1	E	258	PHE	4.6
1	E	222	VAL	4.5
1	H	222	VAL	4.5
1	F	242	SER	4.5
1	G	258	PHE	4.5
1	A	223	ASP	4.4
1	H	217	ALA	4.4
1	L	215	GLY	4.4
1	B	216	PHE	4.4
1	I	121	LEU	4.3
1	L	219	SER	4.3

*Continued on next page...*

*Continued from previous page...*

<b>Mol</b>	<b>Chain</b>	<b>Res</b>	<b>Type</b>	<b>RSRZ</b>
1	G	220	VAL	4.2
1	L	241	ARG	4.2
1	A	210	GLY	4.1
1	I	219	SER	4.1
1	I	242	SER	4.1
1	K	214	PRO	4.1
1	L	220	VAL	4.0
1	E	243	SER	4.0
1	B	240	ALA	4.0
1	F	217	ALA	4.0
1	H	242	SER	4.0
1	E	215	GLY	4.0
1	C	217	ALA	4.0
1	I	222	VAL	4.0
1	E	307	ASP	3.9
1	A	241	ARG	3.9
1	I	255	ASP	3.9
1	L	218	ASP	3.9
1	J	212	ALA	3.9
1	I	223	ASP	3.9
1	G	242	SER	3.8
1	A	220	VAL	3.8
1	B	242	SER	3.8
1	B	134	GLU	3.7
1	I	3	ALA	3.7
1	I	225	TYR	3.7
1	C	218	ASP	3.7
1	F	258	PHE	3.6
1	B	215	GLY	3.6
1	H	225	TYR	3.6
1	L	214	PRO	3.6
1	K	225	TYR	3.6
1	F	255	ASP	3.6
1	A	106	CYS	3.5
1	H	220	VAL	3.5
1	F	222	VAL	3.5
1	J	220	VAL	3.5
1	I	239	PHE	3.5
1	H	255	ASP	3.5
1	D	258	PHE	3.5
1	G	241	ARG	3.5
1	J	222	VAL	3.5

*Continued on next page...*

*Continued from previous page...*

<b>Mol</b>	<b>Chain</b>	<b>Res</b>	<b>Type</b>	<b>RSRZ</b>
1	H	258	PHE	3.4
1	D	218	ASP	3.4
1	G	216	PHE	3.4
1	J	4	VAL	3.4
1	K	219	SER	3.4
1	L	258	PHE	3.4
1	A	221	GLN	3.4
1	E	212	ALA	3.4
1	L	239	PHE	3.4
1	L	134	GLU	3.3
1	B	57	ASN	3.3
1	J	237	TYR	3.3
1	J	219	SER	3.3
1	D	243	SER	3.2
1	E	216	PHE	3.2
1	K	227	HIS	3.2
1	C	19	TRP	3.2
1	K	239	PHE	3.2
1	E	241	ARG	3.2
1	K	302	GLU	3.1
1	B	214	PRO	3.1
1	L	222	VAL	3.1
1	F	212	ALA	3.1
1	G	350	GLN	3.1
1	C	133	LYS	3.1
1	C	224	LYS	3.1
1	I	241	ARG	3.1
1	C	237	TYR	3.1
1	B	212	ALA	3.1
1	B	121	LEU	3.0
1	J	240	ALA	3.0
1	J	231	GLN	3.0
1	K	307	ASP	3.0
1	G	254	THR	3.0
1	L	225	TYR	2.9
1	I	211	PRO	2.9
1	K	7	LEU	2.9
1	C	255	ASP	2.9
1	J	239	PHE	2.9
1	K	354	ILE	2.9
1	C	225	TYR	2.9
1	E	221	GLN	2.9

*Continued on next page...*

*Continued from previous page...*

<b>Mol</b>	<b>Chain</b>	<b>Res</b>	<b>Type</b>	<b>RSRZ</b>
1	B	258	PHE	2.9
1	K	218	ASP	2.9
1	C	219	SER	2.9
1	A	361	TYR	2.9
1	E	217	ALA	2.8
1	K	237	TYR	2.8
1	K	3	ALA	2.8
1	H	223	ASP	2.8
1	C	9	GLU	2.8
1	G	121	LEU	2.8
1	K	121	LEU	2.8
1	L	242	SER	2.8
1	A	243	SER	2.8
1	K	226	TRP	2.7
1	D	121	LEU	2.7
1	A	303	GLU	2.7
1	J	371	GLN	2.7
1	K	304	LEU	2.7
1	H	254	THR	2.7
1	B	307	ASP	2.7
1	I	307	ASP	2.7
1	L	6	LYS	2.7
1	J	214	PRO	2.7
1	J	350	GLN	2.7
1	A	218	ASP	2.7
1	L	349	LYS	2.7
1	H	231	GLN	2.7
1	K	231	GLN	2.7
1	C	127	HIS	2.6
1	A	174	GLN	2.6
1	I	212	ALA	2.6
1	D	134	GLU	2.6
1	K	18	ALA	2.6
1	K	312	ILE	2.6
1	A	362	PHE	2.6
1	D	223	ASP	2.6
1	A	123	ARG	2.6
1	A	302	GLU	2.6
1	D	42	LYS	2.6
1	E	237	TYR	2.6
1	A	217	ALA	2.6
1	H	221	GLN	2.6

*Continued on next page...*

*Continued from previous page...*

<b>Mol</b>	<b>Chain</b>	<b>Res</b>	<b>Type</b>	<b>RSRZ</b>
1	K	273	PRO	2.6
1	A	13	ALA	2.6
1	B	239	PHE	2.6
1	K	299	PHE	2.5
1	L	223	ASP	2.5
1	L	237	TYR	2.5
1	B	223	ASP	2.5
1	B	59	TYR	2.5
1	G	225	TYR	2.5
1	B	210	GLY	2.5
1	D	212	ALA	2.5
1	B	222	VAL	2.4
1	K	45	ILE	2.4
1	G	3	ALA	2.4
1	L	9	GLU	2.4
1	A	312	ILE	2.4
1	L	106	CYS	2.4
1	J	3	ALA	2.4
1	H	212	ALA	2.4
1	C	82	PHE	2.4
1	B	3	ALA	2.4
1	K	210	GLY	2.4
1	K	221	GLN	2.4
1	B	8	PRO	2.4
1	A	121	LEU	2.3
1	C	214	PRO	2.3
1	I	371	GLN	2.3
1	K	13	ALA	2.3
1	D	7	LEU	2.3
1	E	239	PHE	2.3
1	A	3	ALA	2.3
1	G	212	ALA	2.3
1	I	9	GLU	2.3
1	I	238	GLY	2.3
1	J	349	LYS	2.3
1	B	100	ALA	2.3
1	A	211	PRO	2.3
1	F	350	GLN	2.2
1	H	241	ARG	2.2
1	J	125	CYS	2.2
1	D	227	HIS	2.2
1	G	218	ASP	2.2

*Continued on next page...*



*Continued from previous page...*

<b>Mol</b>	<b>Chain</b>	<b>Res</b>	<b>Type</b>	<b>RSRZ</b>
1	L	231	GLN	2.2
1	C	361	TYR	2.2
1	I	258	PHE	2.2
1	B	135	ASN	2.2
1	L	212	ALA	2.2
1	F	121	LEU	2.2
1	L	311	LEU	2.2
1	D	9	GLU	2.2
1	I	349	LYS	2.2
1	B	126	ASP	2.2
1	I	304	LEU	2.2
1	J	211	PRO	2.2
1	K	106	CYS	2.2
1	K	134	GLU	2.2
1	L	4	VAL	2.1
1	L	211	PRO	2.1
1	K	272	PRO	2.1
1	J	224	LYS	2.1
1	H	218	ASP	2.1
1	B	241	ARG	2.1
1	E	220	VAL	2.1
1	I	215	GLY	2.1
1	D	224	LYS	2.1
1	D	241	ARG	2.1
1	H	215	GLY	2.1
1	J	126	ASP	2.1
1	B	116	ASP	2.1
1	B	102	ASN	2.0
1	J	121	LEU	2.0
1	I	237	TYR	2.0
1	K	303	GLU	2.0
1	E	277	PHE	2.0
1	J	238	GLY	2.0
1	L	319	PHE	2.0
1	I	361	TYR	2.0
1	D	214	PRO	2.0
1	A	354	ILE	2.0
1	E	186	ALA	2.0
1	G	125	CYS	2.0
1	B	30	GLN	2.0
1	C	220	VAL	2.0

## 6.2 Non-standard residues in protein, DNA, RNA chains [i](#)

There are no non-standard protein/DNA/RNA residues in this entry.

## 6.3 Carbohydrates [i](#)

There are no monosaccharides in this entry.

## 6.4 Ligands [i](#)

In the following table, the Atoms column lists the number of modelled atoms in the group and the number defined in the chemical component dictionary. The B-factors column lists the minimum, median, 95<sup>th</sup> percentile and maximum values of B factors of atoms in the group. The column labelled 'Q< 0.9' lists the number of atoms with occupancy less than 0.9.

Mol	Type	Chain	Res	Atoms	RSCC	RSR	B-factors(Å <sup>2</sup> )	Q<0.9
4	QKQ	A	403	29/29	0.55	0.41	70,78,91,91	0
4	QKQ	I	403	29/29	0.56	0.47	56,69,83,85	0
4	QKQ	D	403	29/29	0.57	0.39	64,70,87,88	0
4	QKQ	B	403	29/29	0.57	0.39	68,71,87,88	0
4	QKQ	L	403	29/29	0.62	0.50	60,67,83,84	0
5	EPE	G	404	15/15	0.63	0.39	43,59,76,79	0
4	QKQ	F	403	29/29	0.64	0.37	57,64,84,86	0
4	QKQ	H	403	29/29	0.64	0.30	57,65,85,86	0
5	EPE	D	404	15/15	0.65	0.47	48,60,77,79	0
4	QKQ	K	403	29/29	0.66	0.36	57,69,85,86	0
4	QKQ	C	403	29/29	0.67	0.32	66,74,90,91	0
5	EPE	J	404	15/15	0.69	0.46	47,59,74,78	0
4	QKQ	E	403	29/29	0.71	0.40	63,70,84,84	0
5	EPE	F	404	15/15	0.71	0.45	49,59,76,77	0
5	EPE	K	404	15/15	0.72	0.35	47,60,74,78	0
5	EPE	B	404	15/15	0.72	0.43	46,61,75,78	0
5	EPE	L	404	15/15	0.73	0.47	46,59,80,82	0
4	QKQ	J	403	29/29	0.73	0.32	61,67,86,87	0
4	QKQ	G	403	29/29	0.76	0.32	55,63,82,83	0
5	EPE	I	404	15/15	0.76	0.37	45,61,77,81	0
5	EPE	H	404	15/15	0.76	0.43	48,59,75,79	0
5	EPE	C	404	15/15	0.77	0.38	47,58,73,79	0
3	FES	H	402	4/4	0.77	0.33	45,76,79,124	0
5	EPE	E	404	15/15	0.79	0.25	47,58,73,78	0
5	EPE	A	404	15/15	0.80	0.29	48,59,73,75	0
3	FES	L	402	4/4	0.80	0.28	39,81,83,137	0
2	FE	F	401	1/1	0.83	0.07	49,49,49,49	0

*Continued on next page...*

*Continued from previous page...*

Mol	Type	Chain	Res	Atoms	RSCC	RSR	B-factors( $\text{\AA}^2$ )	Q<0.9
3	FES	F	402	4/4	0.83	0.16	34,35,36,37	0
3	FES	D	402	4/4	0.85	0.14	33,38,40,60	0
3	FES	J	402	4/4	0.87	0.17	42,53,57,73	0
2	FE	I	401	1/1	0.88	0.09	61,61,61,61	0
3	FES	A	402	4/4	0.89	0.22	33,52,80,81	0
2	FE	D	401	1/1	0.90	0.10	63,63,63,63	0
3	FES	G	402	4/4	0.90	0.15	34,43,44,63	0
2	FE	B	401	1/1	0.90	0.15	63,63,63,63	0
2	FE	K	401	1/1	0.90	0.06	63,63,63,63	0
2	FE	E	401	1/1	0.91	0.07	55,55,55,55	0
2	FE	H	401	1/1	0.92	0.07	56,56,56,56	0
3	FES	K	402	4/4	0.92	0.17	37,43,45,54	0
3	FES	E	402	4/4	0.92	0.14	33,34,36,39	0
2	FE	A	401	1/1	0.93	0.07	81,81,81,81	0
2	FE	C	401	1/1	0.93	0.05	64,64,64,64	0
3	FES	I	402	4/4	0.93	0.15	36,37,37,54	0
3	FES	C	402	4/4	0.93	0.12	48,49,53,61	0
2	FE	L	401	1/1	0.94	0.09	56,56,56,56	0
3	FES	B	402	4/4	0.95	0.09	38,43,44,47	0
2	FE	J	401	1/1	0.96	0.08	72,72,72,72	0
2	FE	G	401	1/1	0.97	0.04	55,55,55,55	0

The following is a graphical depiction of the model fit to experimental electron density of all instances of the Ligand of Interest. In addition, ligands with molecular weight > 250 and outliers as shown on the geometry validation Tables will also be included. Each fit is shown from different orientation to approximate a three-dimensional view.

**Electron density around QKQ A 403:**

$2mF_o-DF_c$  (at 0.7 rmsd) in gray  
 $mF_o-DF_c$  (at 3 rmsd) in purple (negative)  
and green (positive)

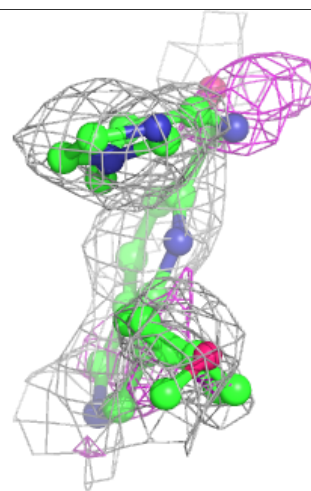
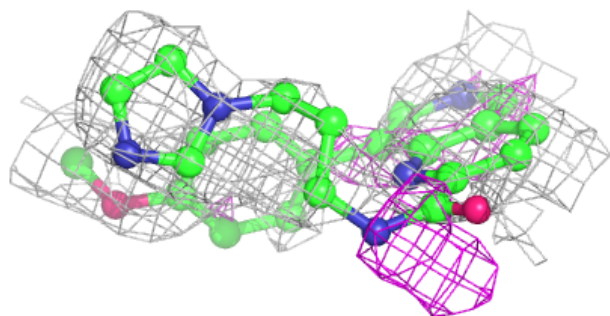
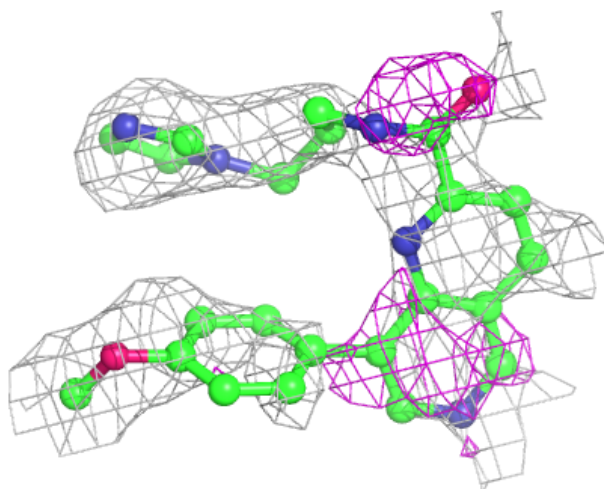

**Electron density around QKQ I 403:**

$2mF_o-DF_c$  (at 0.7 rmsd) in gray  
 $mF_o-DF_c$  (at 3 rmsd) in purple (negative)  
and green (positive)

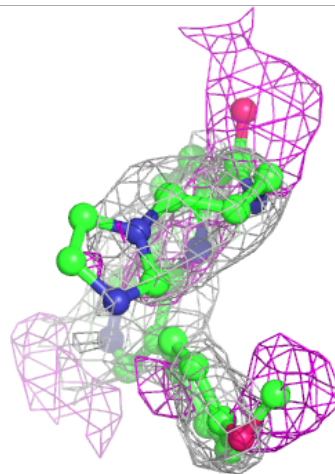
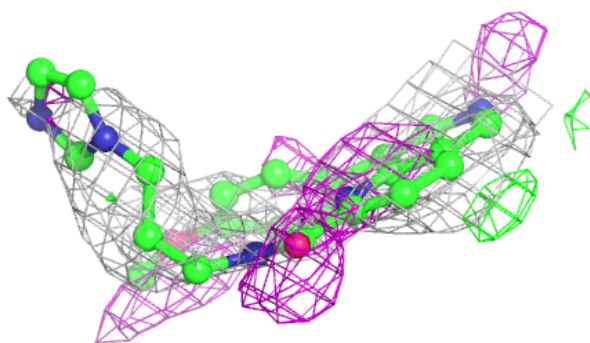
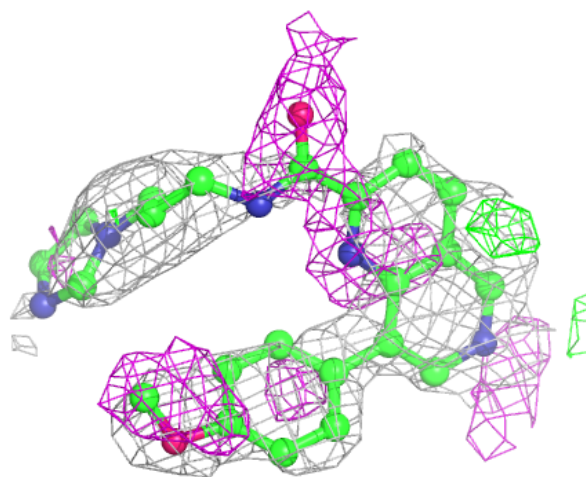

**Electron density around QKQ D 403:**

$2mF_o-DF_c$  (at 0.7 rmsd) in gray  
 $mF_o-DF_c$  (at 3 rmsd) in purple (negative)  
and green (positive)

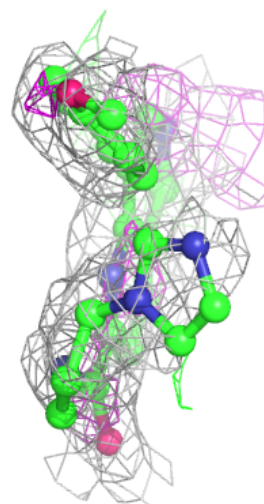
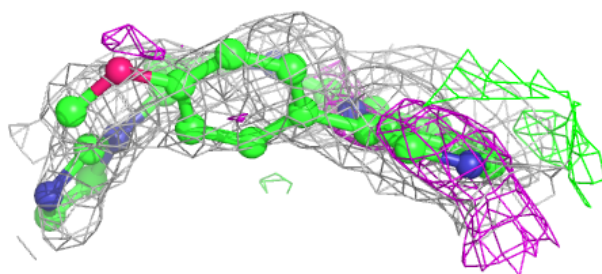
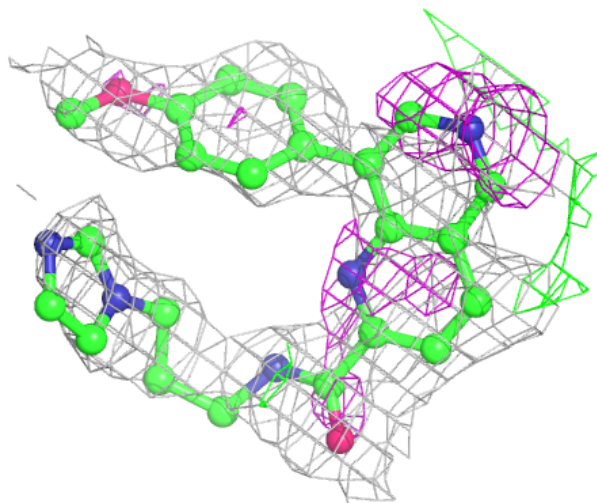

**Electron density around QKQ B 403:**

$2mF_o-DF_c$  (at 0.7 rmsd) in gray  
 $mF_o-DF_c$  (at 3 rmsd) in purple (negative)  
and green (positive)

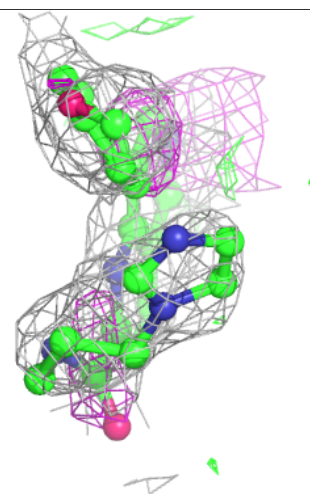
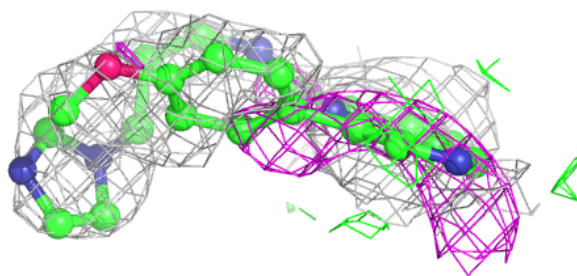
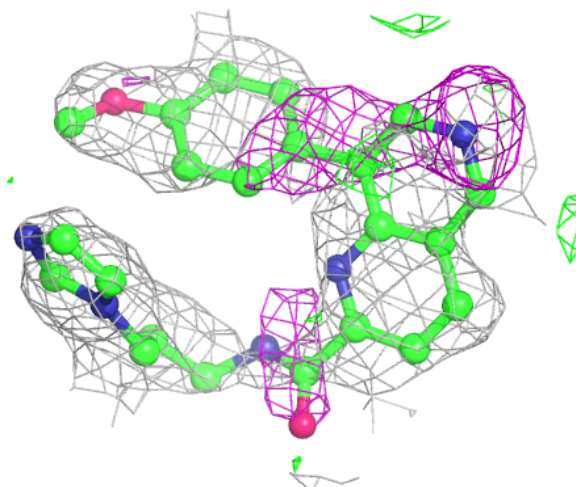

**Electron density around QKQ L 403:**

$2mF_o-DF_c$  (at 0.7 rmsd) in gray  
 $mF_o-DF_c$  (at 3 rmsd) in purple (negative)  
and green (positive)

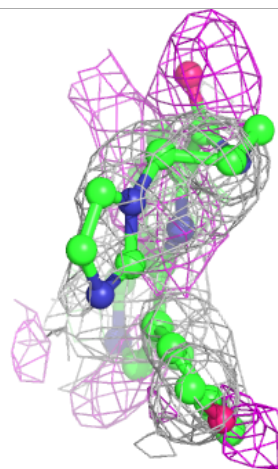
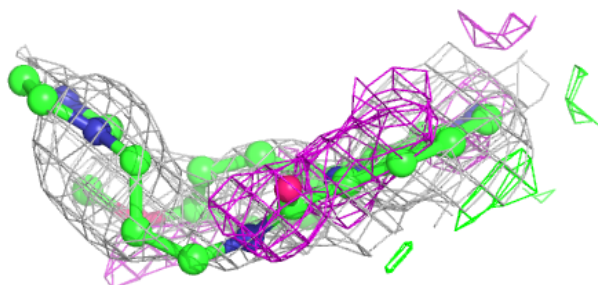
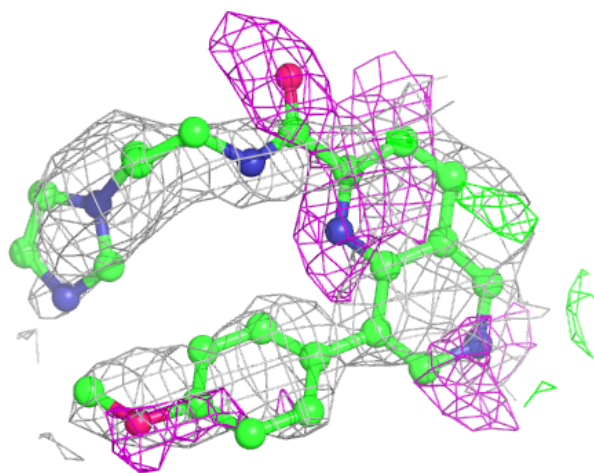



**Electron density around QKQ F 403:**

$2mF_o-DF_c$  (at 0.7 rmsd) in gray  
 $mF_o-DF_c$  (at 3 rmsd) in purple (negative)  
and green (positive)

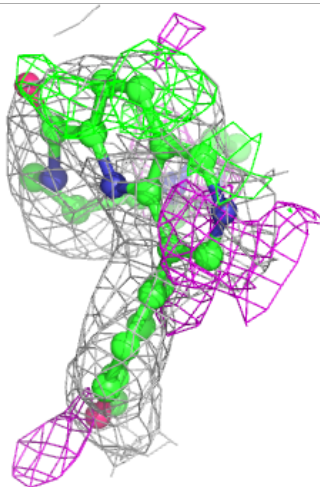
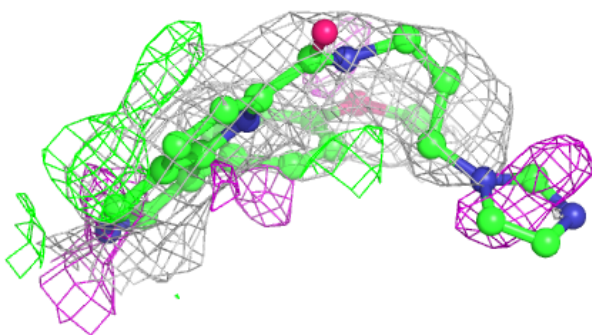
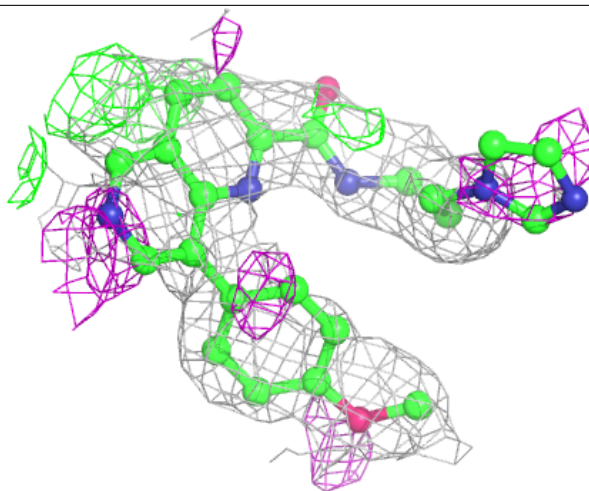

**Electron density around QKQ H 403:**

$2mF_o-DF_c$  (at 0.7 rmsd) in gray  
 $mF_o-DF_c$  (at 3 rmsd) in purple (negative)  
and green (positive)

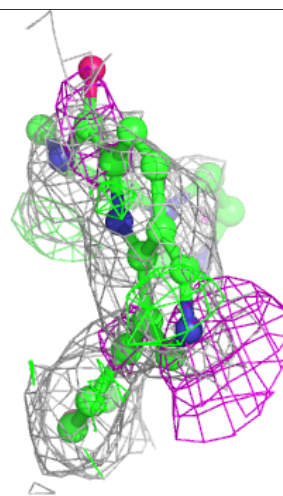
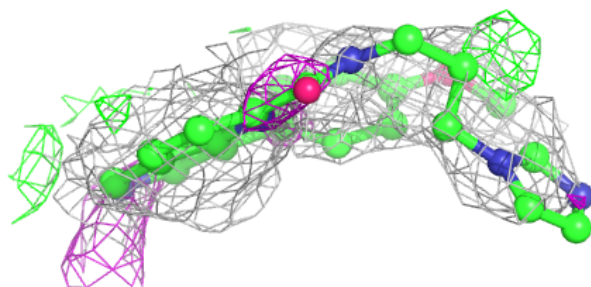
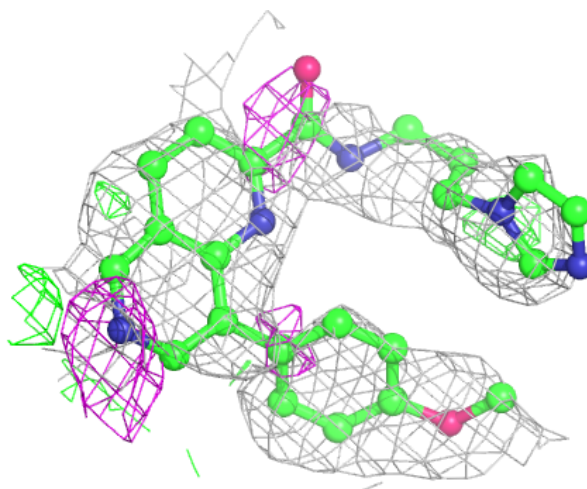

**Electron density around QKQ K 403:**

$2mF_o-DF_c$  (at 0.7 rmsd) in gray  
 $mF_o-DF_c$  (at 3 rmsd) in purple (negative)  
and green (positive)

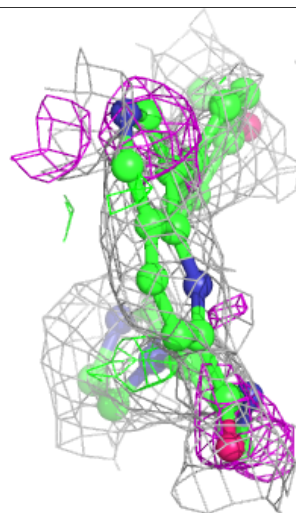
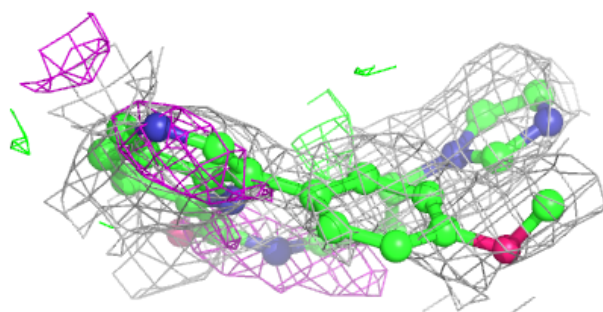
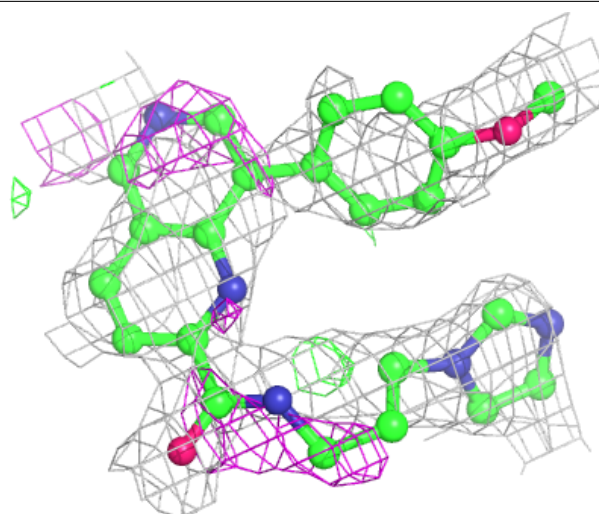

**Electron density around QKQ C 403:**

$2mF_o-DF_c$  (at 0.7 rmsd) in gray  
 $mF_o-DF_c$  (at 3 rmsd) in purple (negative)  
and green (positive)

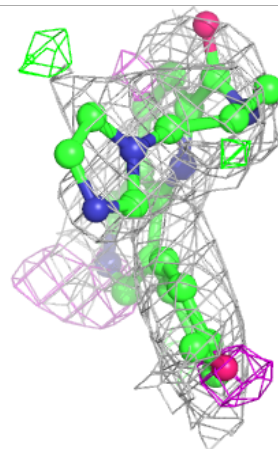
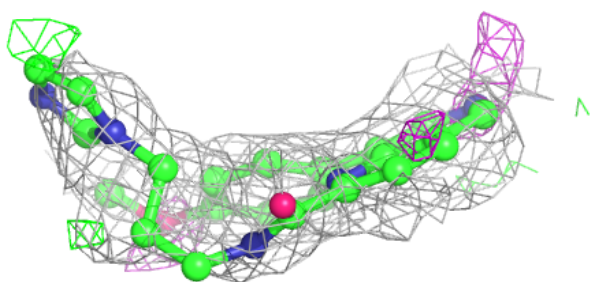
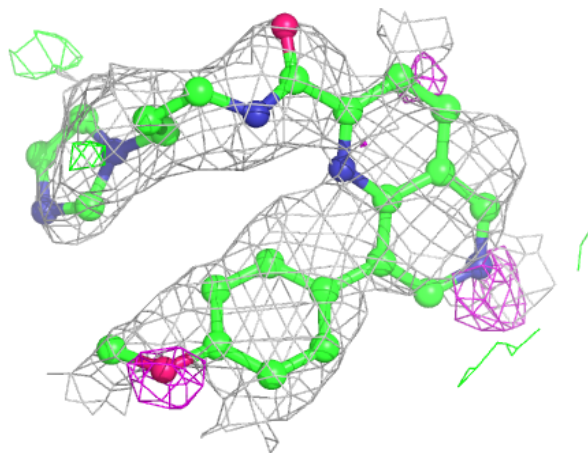

**Electron density around QKQ E 403:**

$2mF_o-DF_c$  (at 0.7 rmsd) in gray  
 $mF_o-DF_c$  (at 3 rmsd) in purple (negative)  
and green (positive)

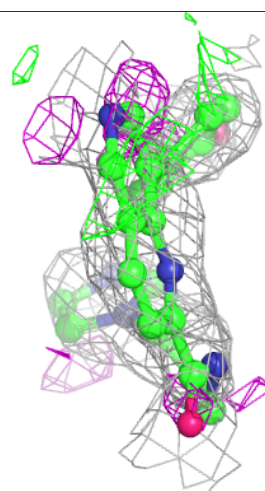
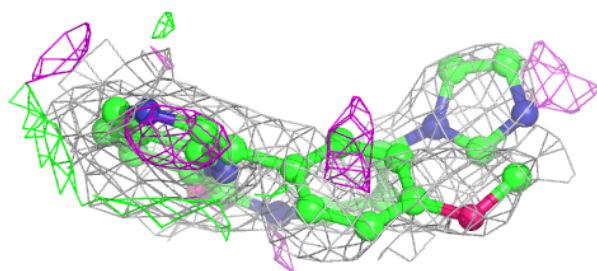
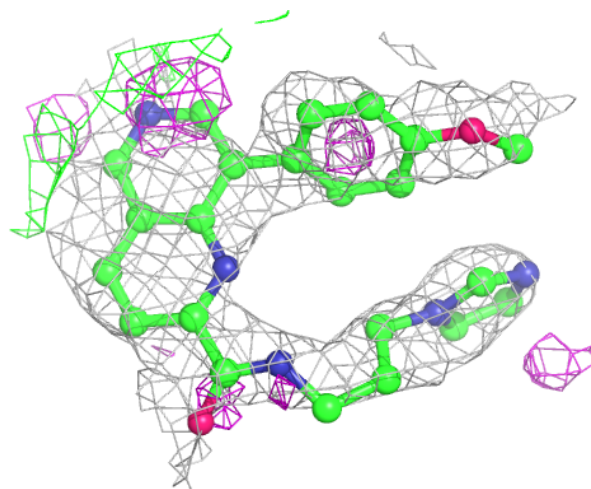

**Electron density around QKQ J 403:**

$2mF_o-DF_c$  (at 0.7 rmsd) in gray  
 $mF_o-DF_c$  (at 3 rmsd) in purple (negative)  
and green (positive)

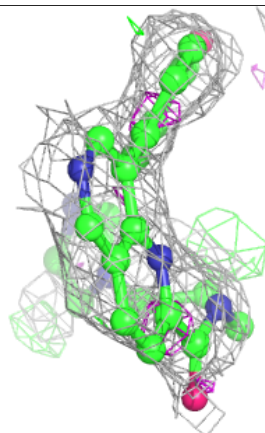
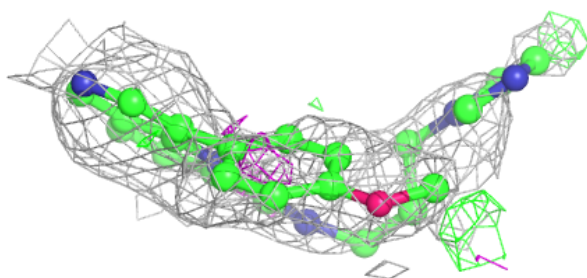
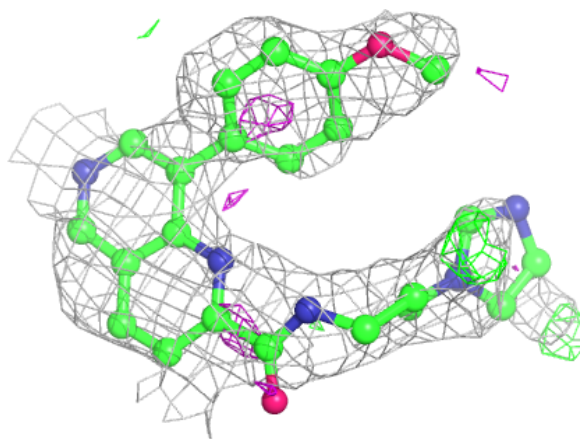

**Electron density around QKQ G 403:**

$2mF_o-DF_c$  (at 0.7 rmsd) in gray  
 $mF_o-DF_c$  (at 3 rmsd) in purple (negative)  
and green (positive)

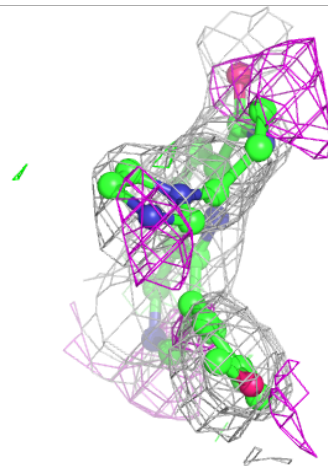
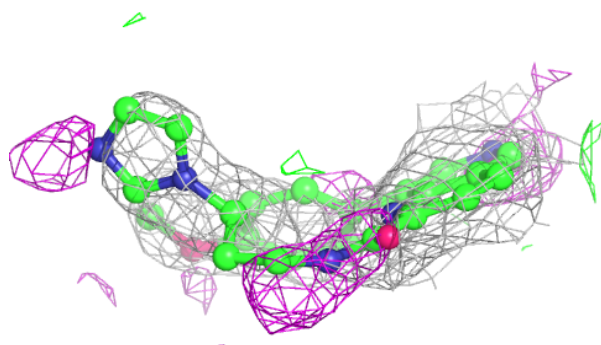
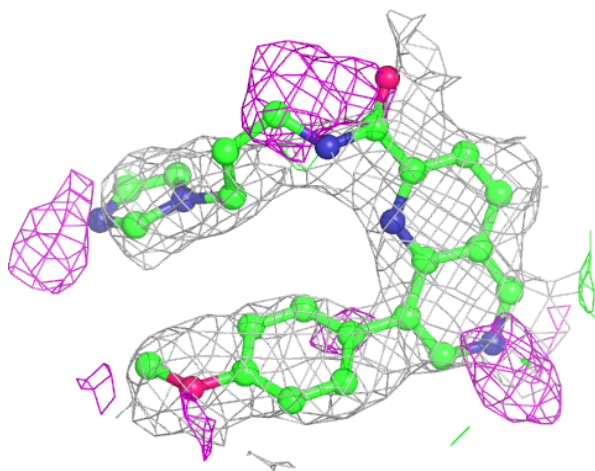

**Electron density around FES H 402:**

$2mF_o-DF_c$  (at 0.7 rmsd) in gray  
 $mF_o-DF_c$  (at 3 rmsd) in purple (negative)  
and green (positive)

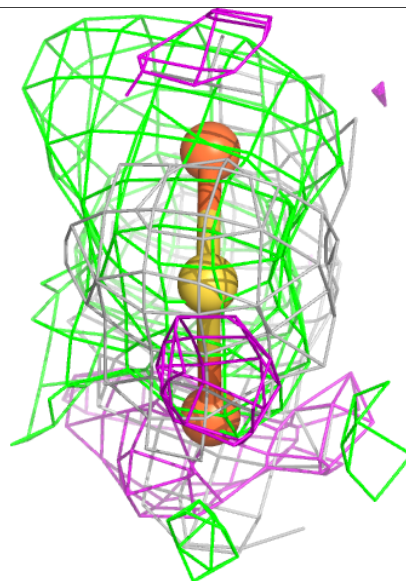
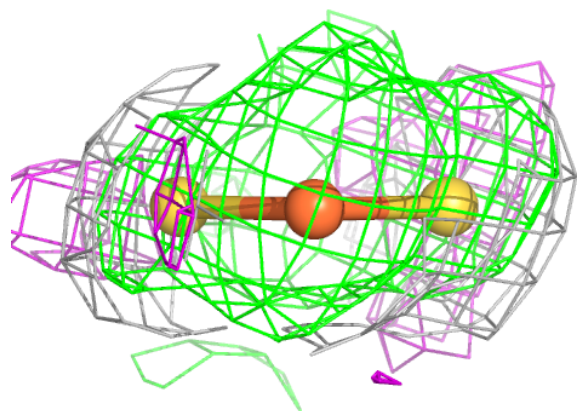
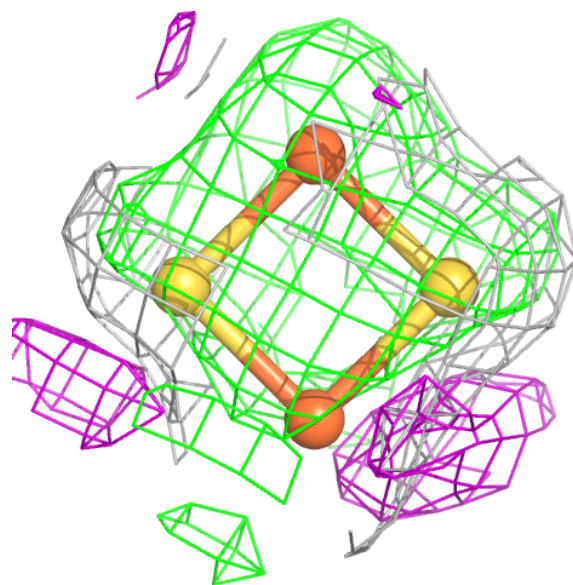



**Electron density around FES L 402:**

$2mF_o-DF_c$  (at 0.7 rmsd) in gray  
 $mF_o-DF_c$  (at 3 rmsd) in purple (negative)  
and green (positive)

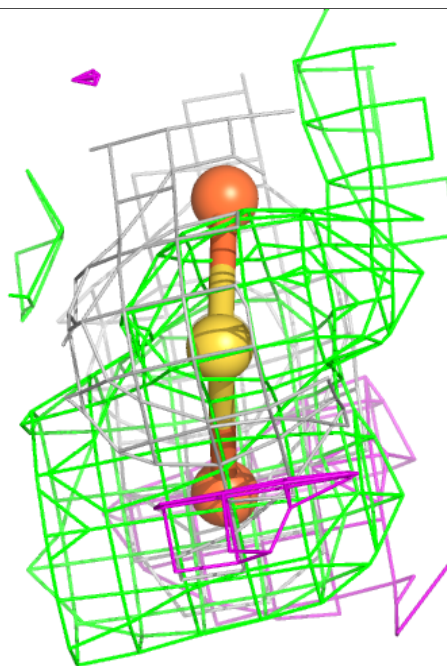
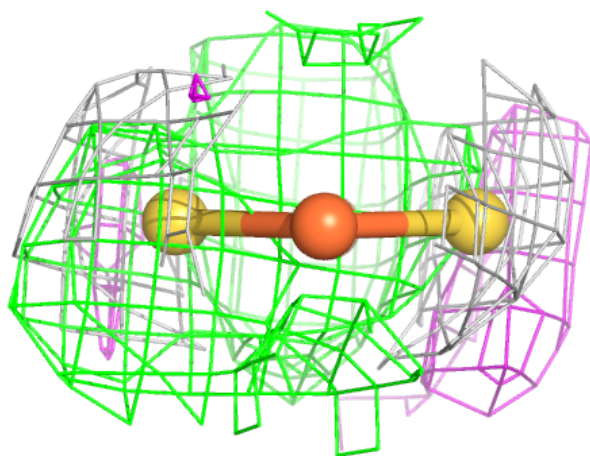
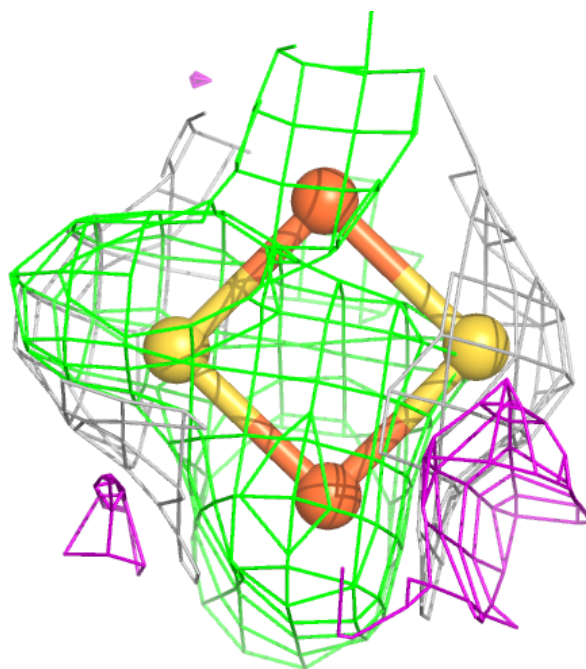

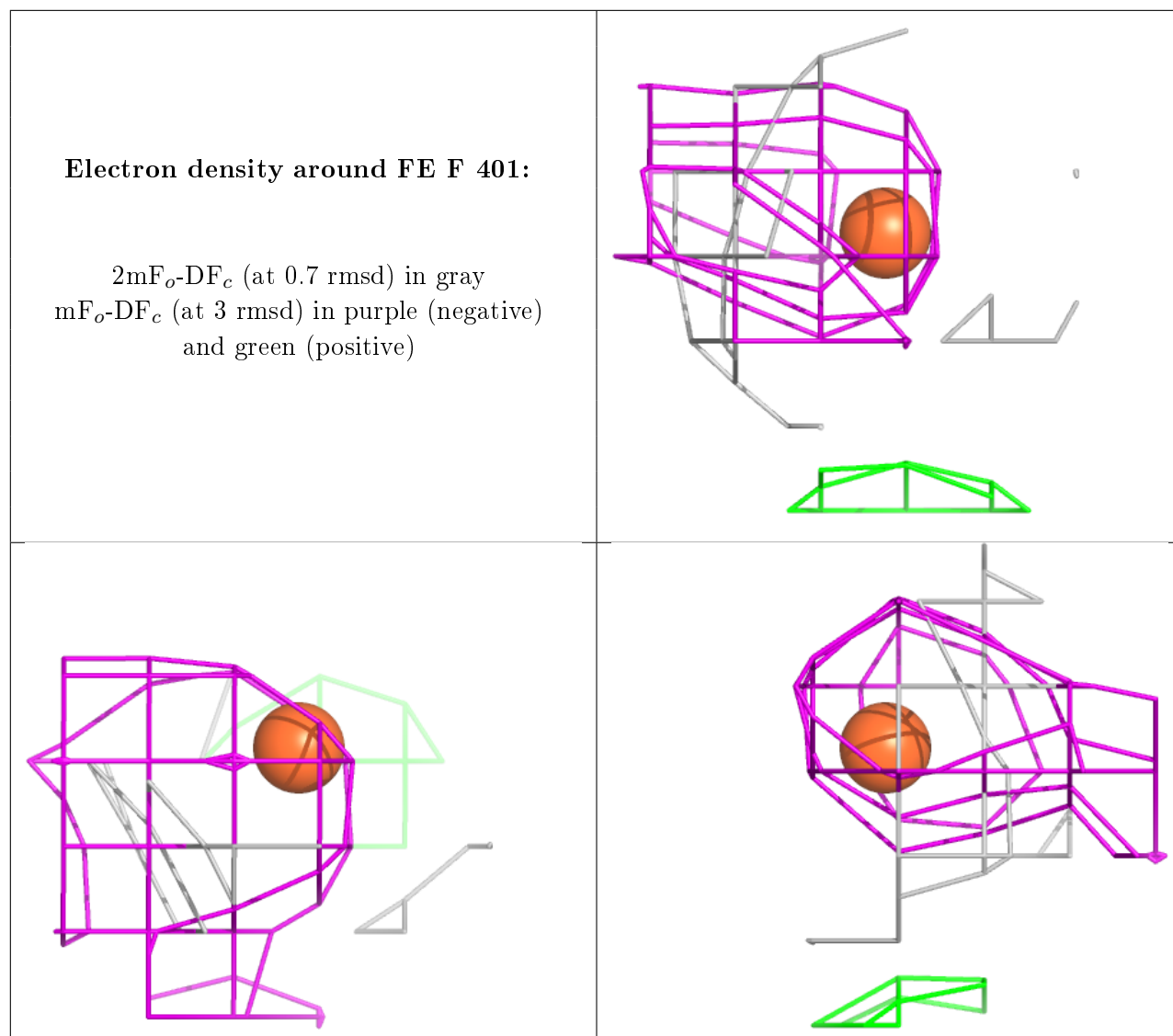

**Electron density around FES F 402:**

$2mF_o-DF_c$  (at 0.7 rmsd) in gray  
 $mF_o-DF_c$  (at 3 rmsd) in purple (negative)  
and green (positive)

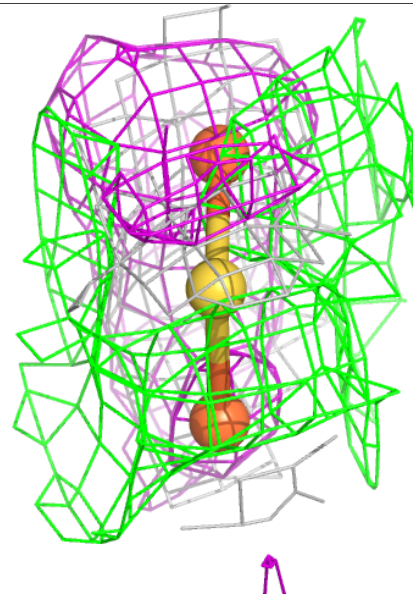
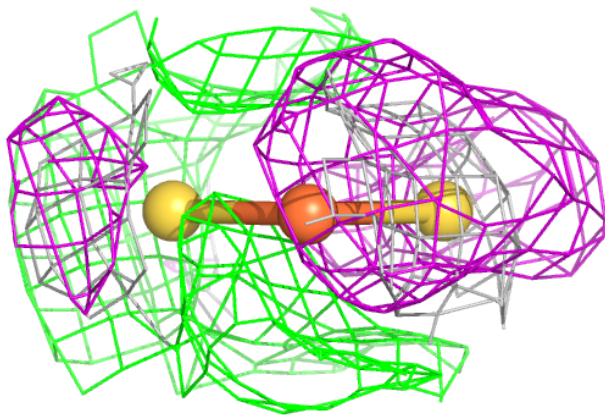
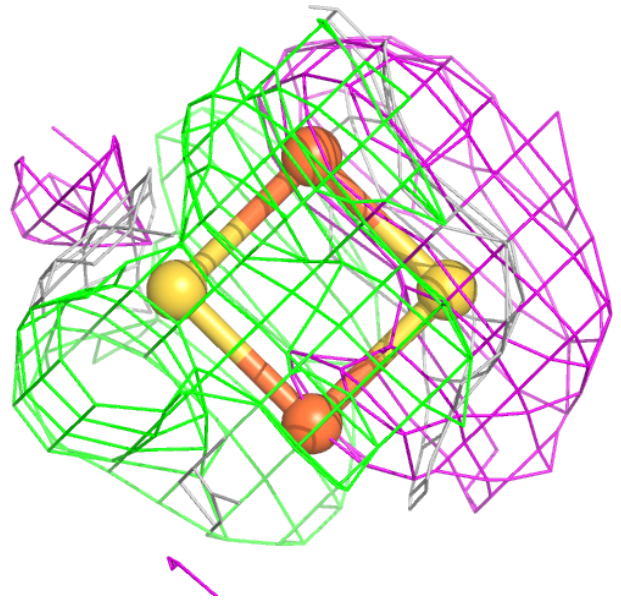

**Electron density around FES D 402:**

$2mF_o-DF_c$  (at 0.7 rmsd) in gray  
 $mF_o-DF_c$  (at 3 rmsd) in purple (negative)  
and green (positive)

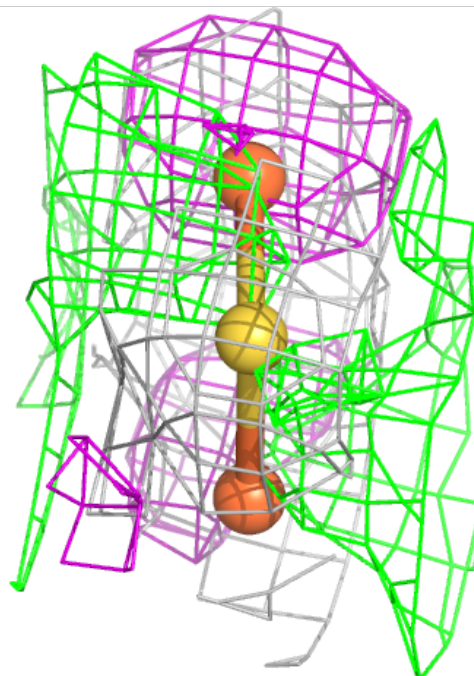
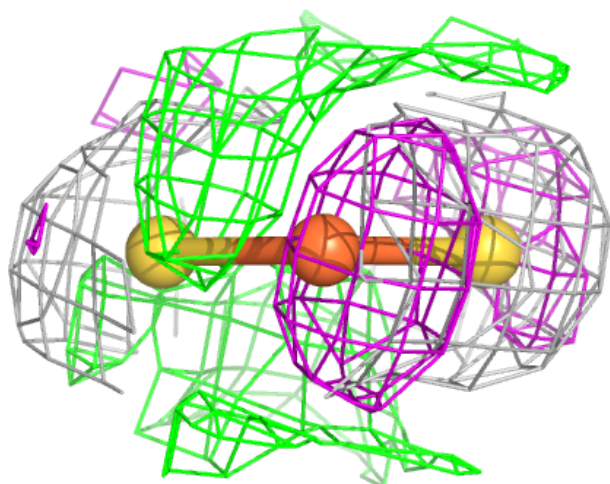
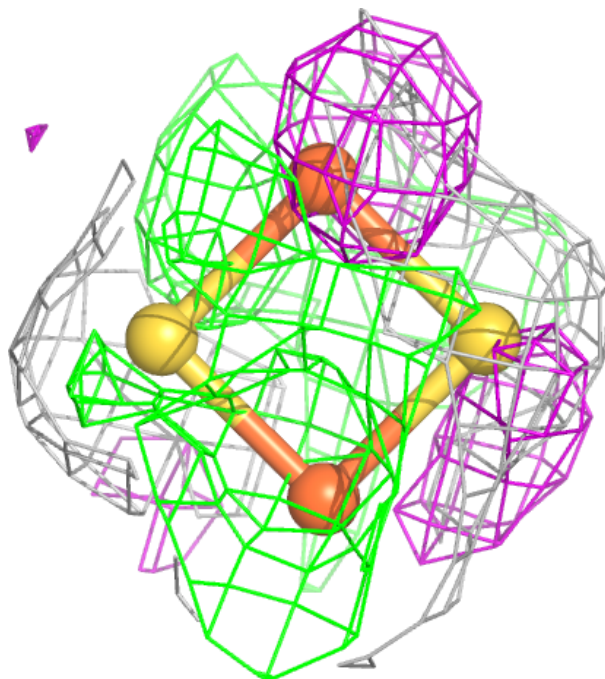

**Electron density around FES J 402:**

$2mF_o-DF_c$  (at 0.7 rmsd) in gray  
 $mF_o-DF_c$  (at 3 rmsd) in purple (negative)  
and green (positive)

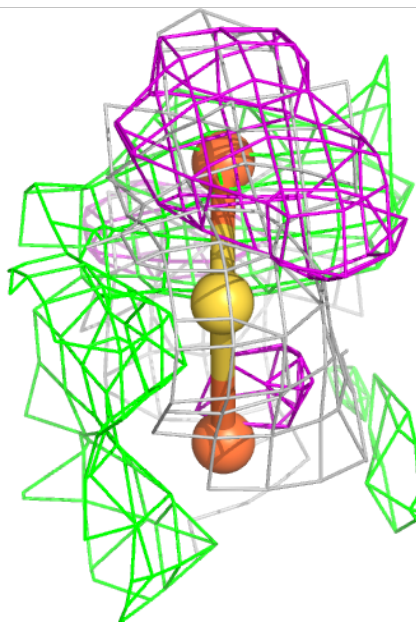
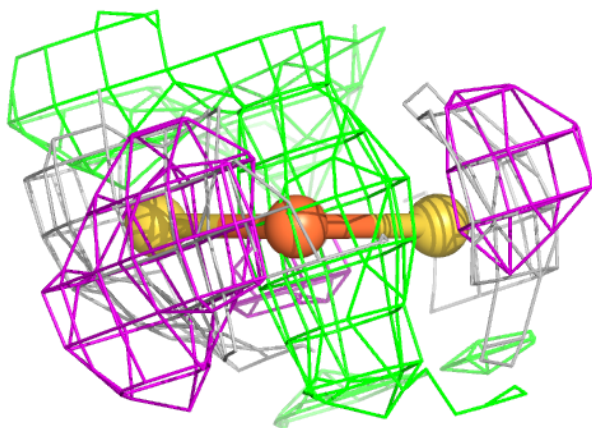
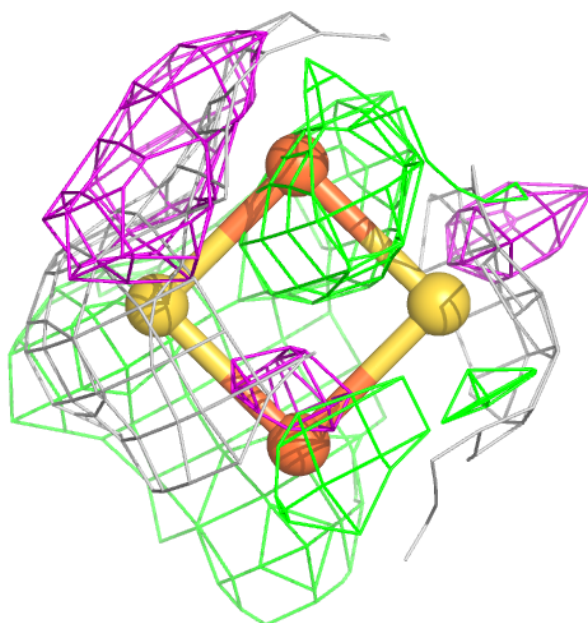

**Electron density around FE I 401:**

$2mF_o-DF_c$  (at 0.7 rmsd) in gray  
 $mF_o-DF_c$  (at 3 rmsd) in purple (negative)  
and green (positive)

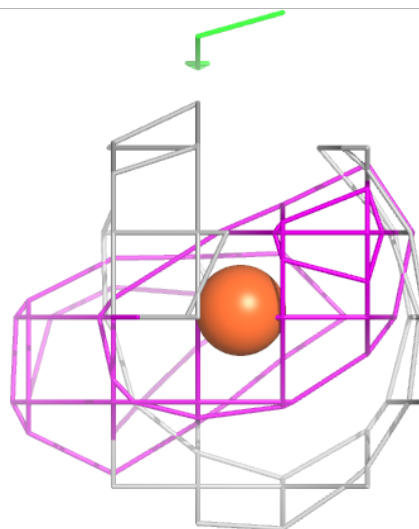
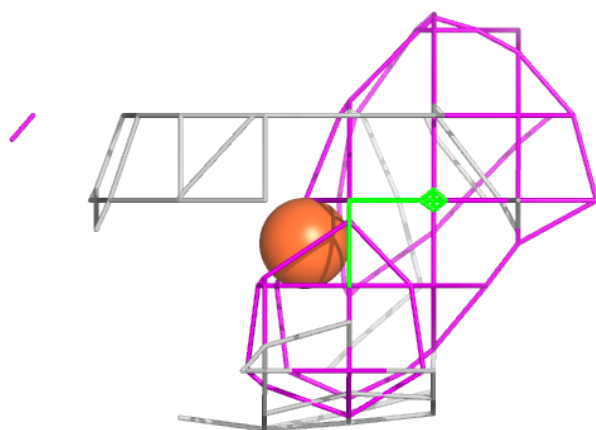
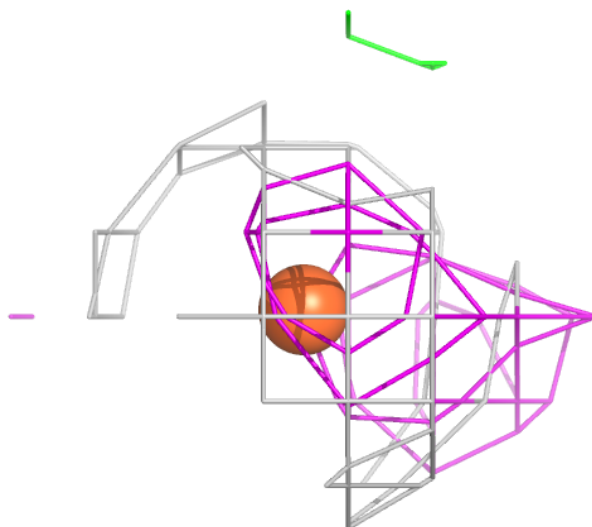

**Electron density around FES A 402:**

$2mF_o-DF_c$  (at 0.7 rmsd) in gray  
 $mF_o-DF_c$  (at 3 rmsd) in purple (negative)  
and green (positive)

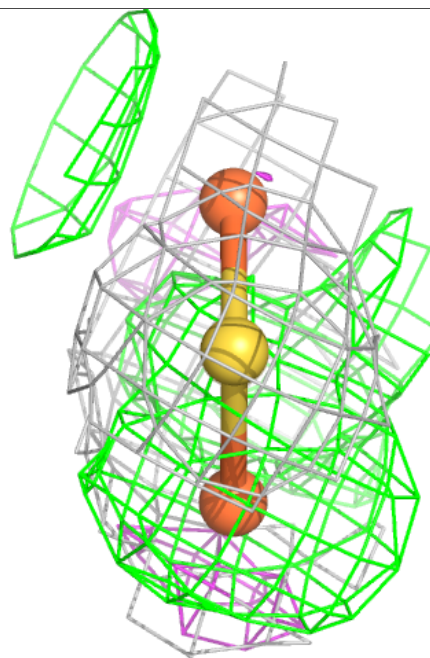
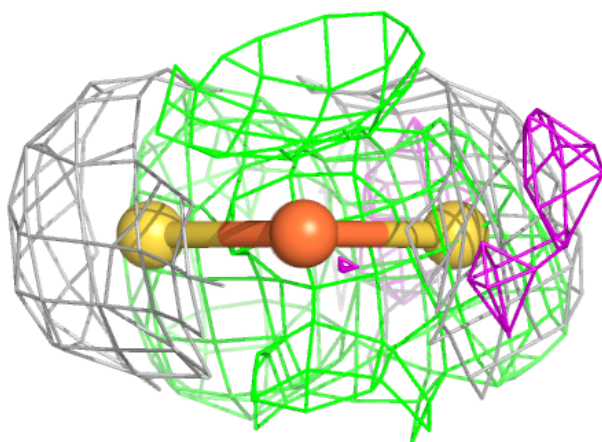
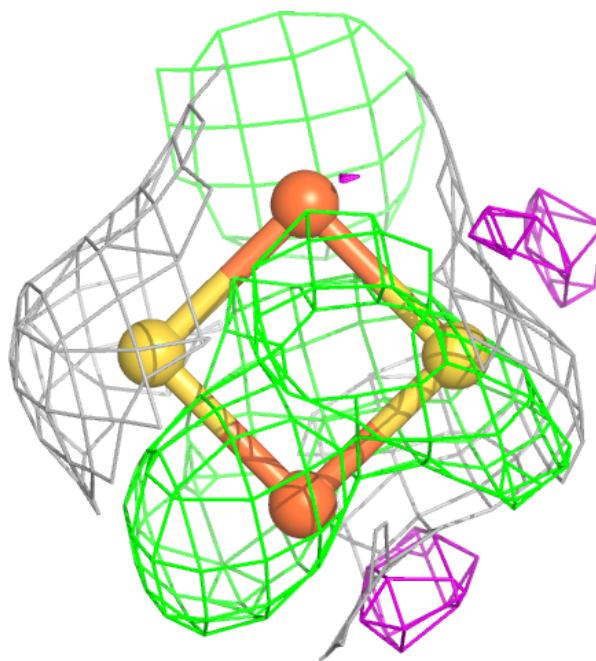

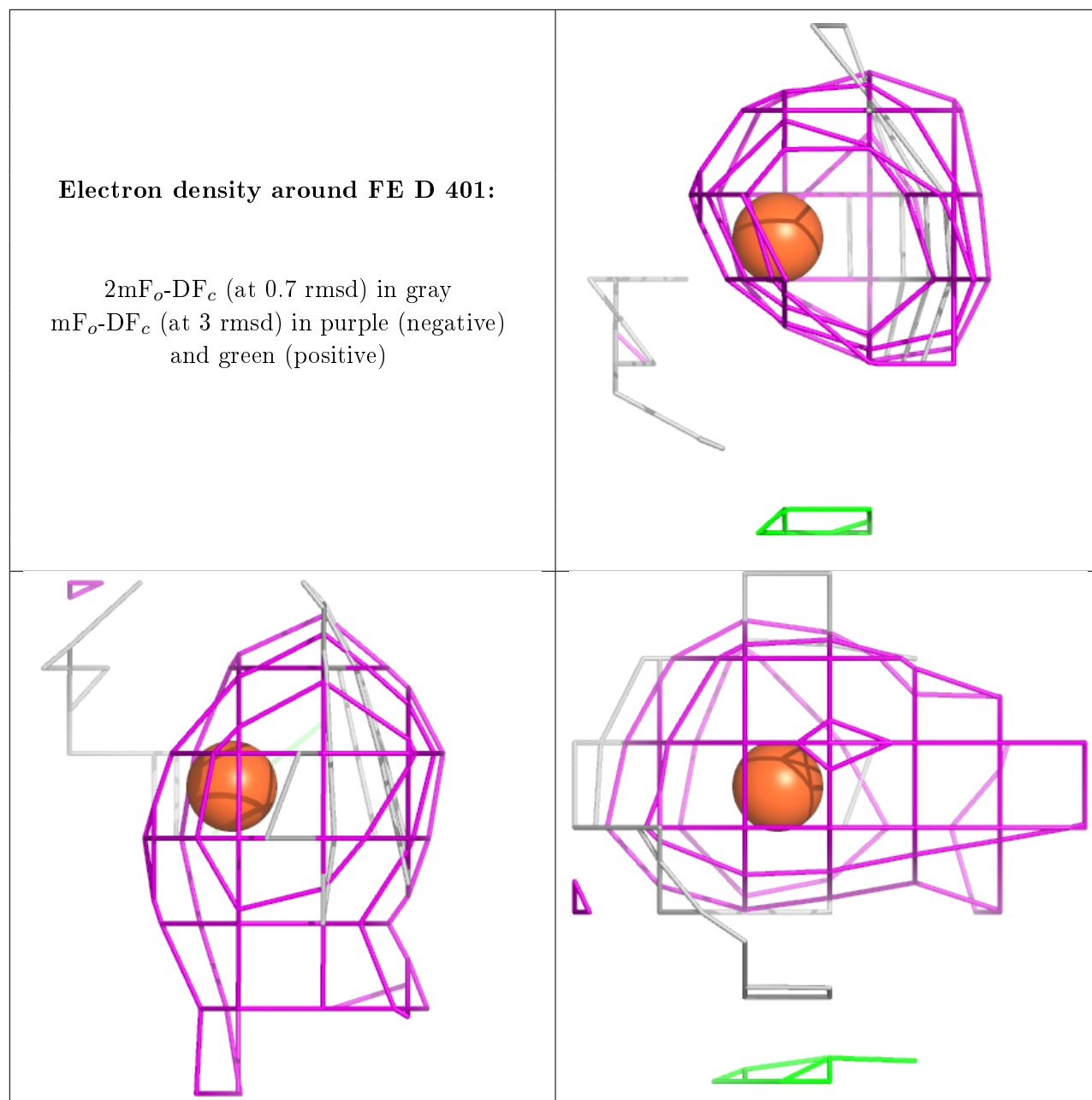



**Electron density around FES G 402:**

$2mF_o-DF_c$  (at 0.7 rmsd) in gray  
 $mF_o-DF_c$  (at 3 rmsd) in purple (negative)  
and green (positive)

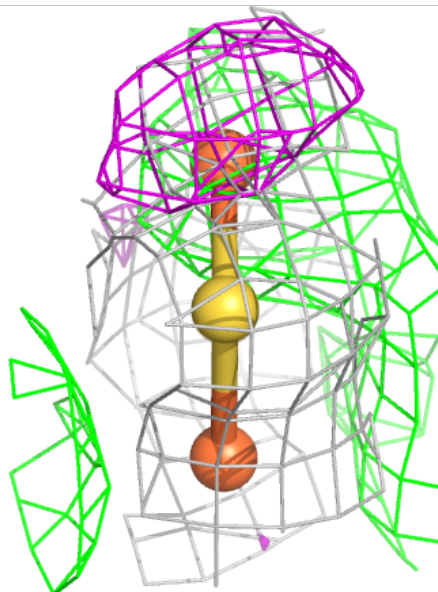
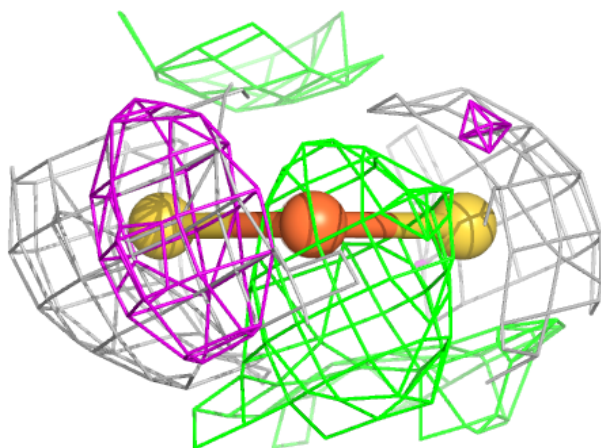
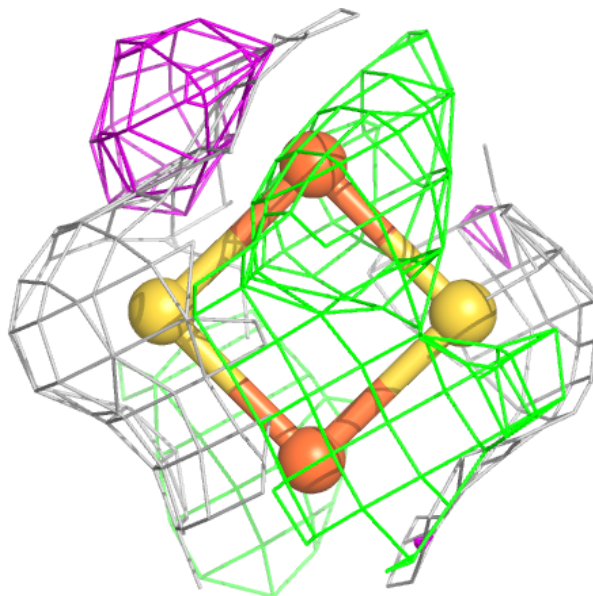

**Electron density around FE B 401:**

$2mF_o-DF_c$  (at 0.7 rmsd) in gray  
 $mF_o-DF_c$  (at 3 rmsd) in purple (negative)  
and green (positive)

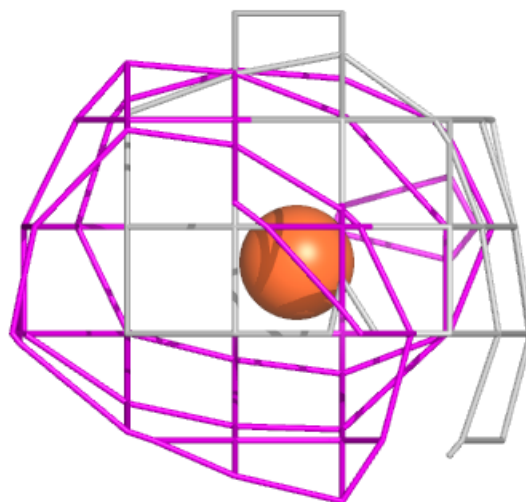
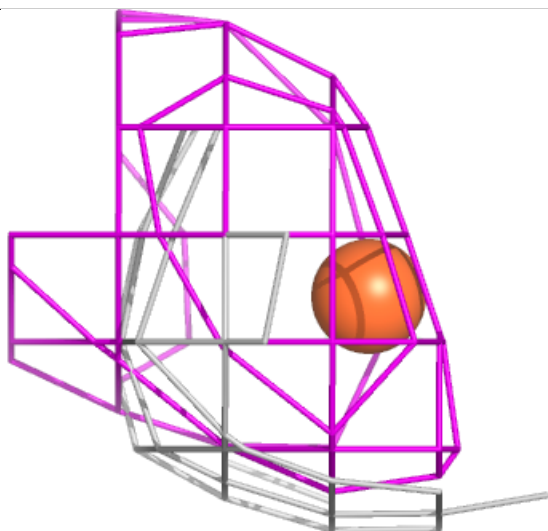
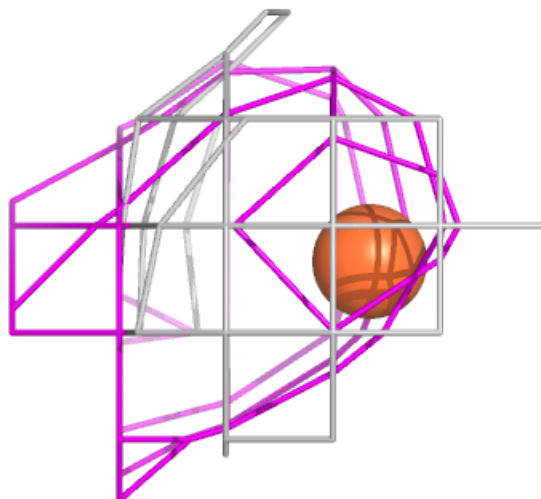

**Electron density around FE K 401:**

$2mF_o-DF_c$  (at 0.7 rmsd) in gray  
 $mF_o-DF_c$  (at 3 rmsd) in purple (negative)  
and green (positive)

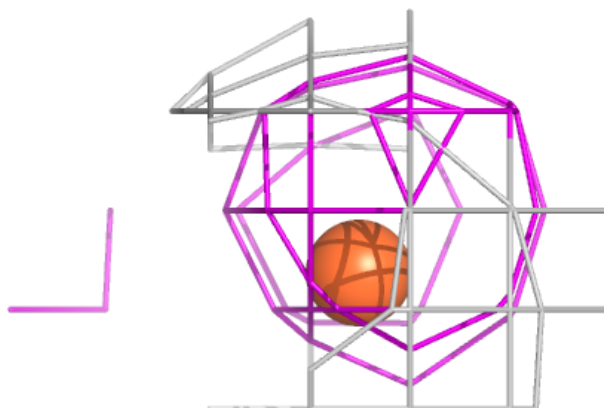
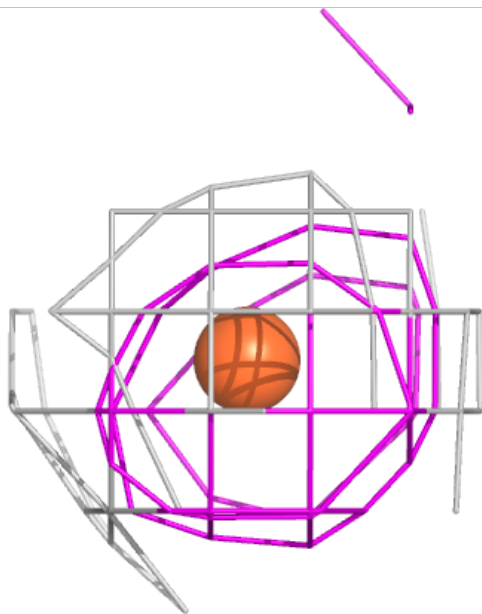
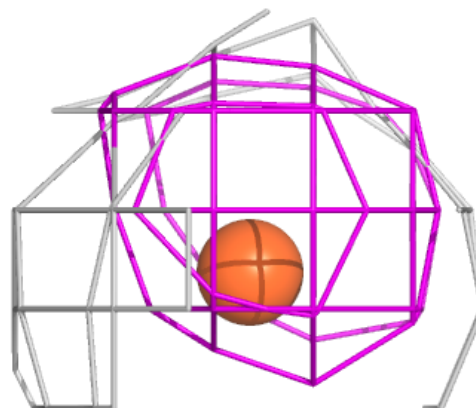

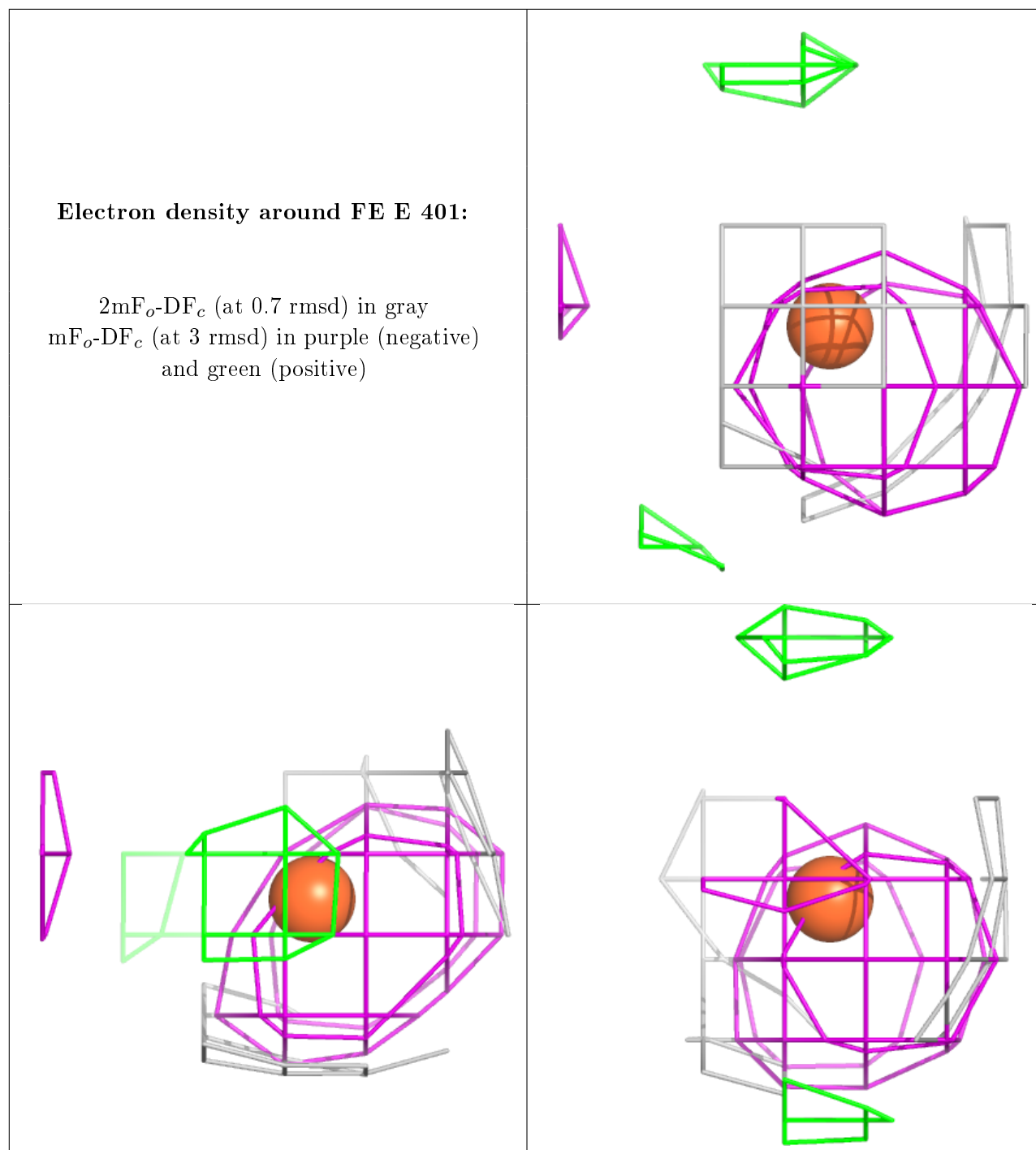

**Electron density around FE H 401:**

$2mF_o-DF_c$  (at 0.7 rmsd) in gray  
 $mF_o-DF_c$  (at 3 rmsd) in purple (negative)  
and green (positive)

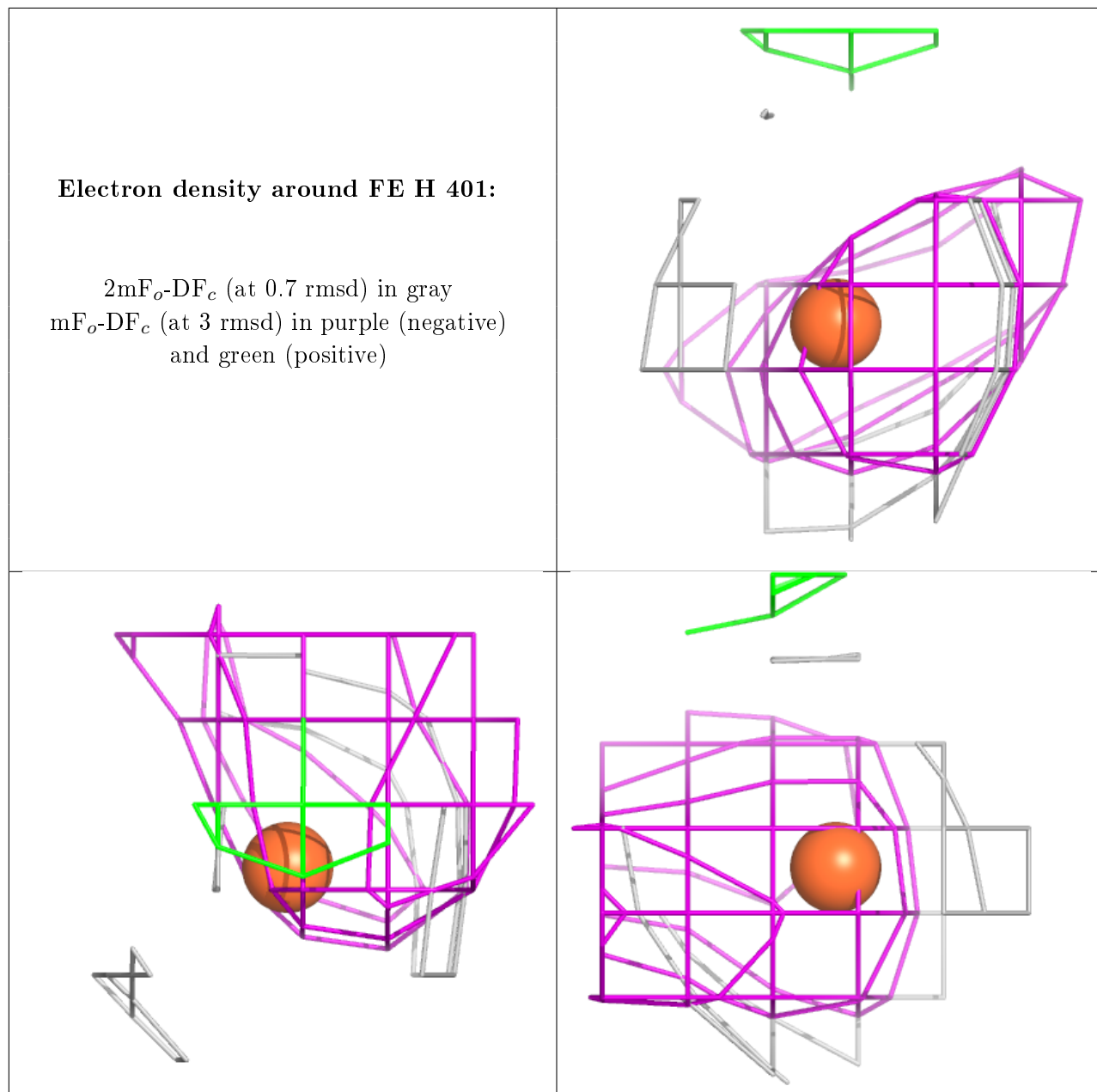

**Electron density around FES K 402:**

$2mF_o-DF_c$  (at 0.7 rmsd) in gray  
 $mF_o-DF_c$  (at 3 rmsd) in purple (negative)  
and green (positive)

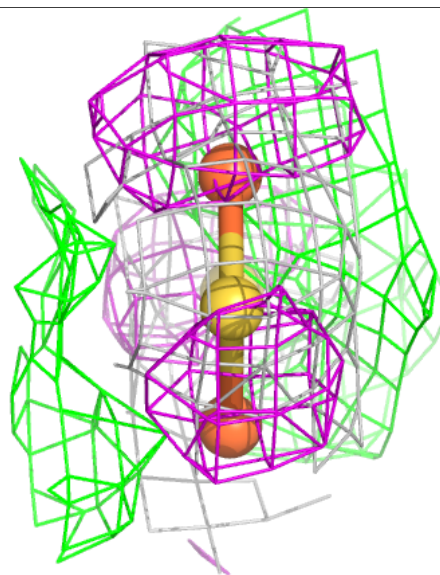
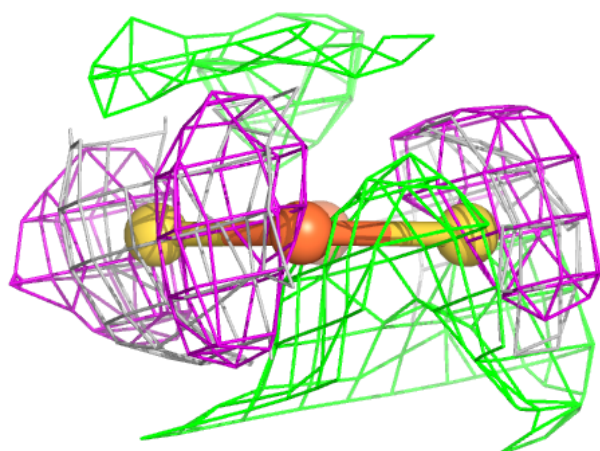
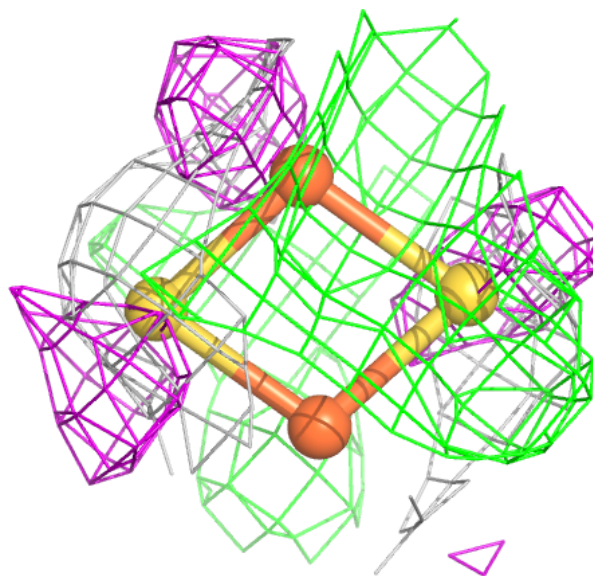

**Electron density around FES E 402:**

$2mF_o-DF_c$  (at 0.7 rmsd) in gray  
 $mF_o-DF_c$  (at 3 rmsd) in purple (negative)  
and green (positive)

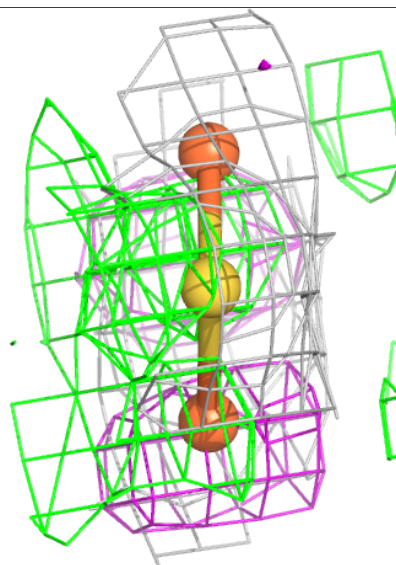
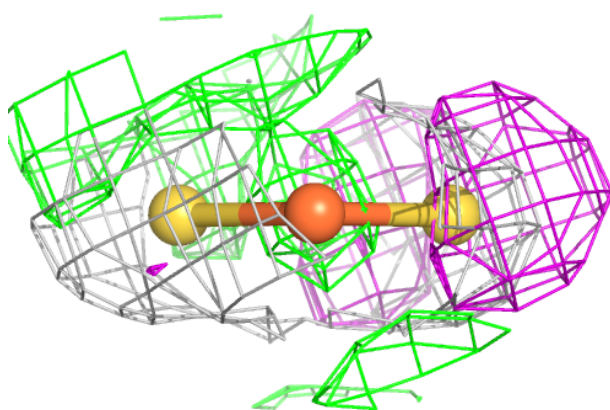
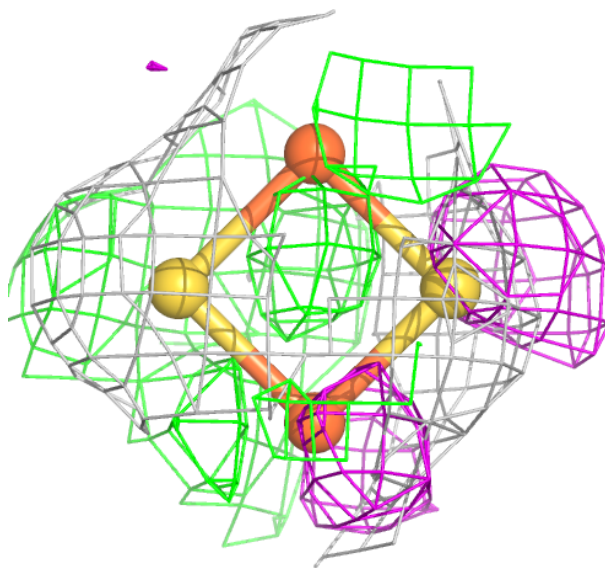

**Electron density around FE A 401:**

$2mF_o-DF_c$  (at 0.7 rmsd) in gray  
 $mF_o-DF_c$  (at 3 rmsd) in purple (negative)  
and green (positive)

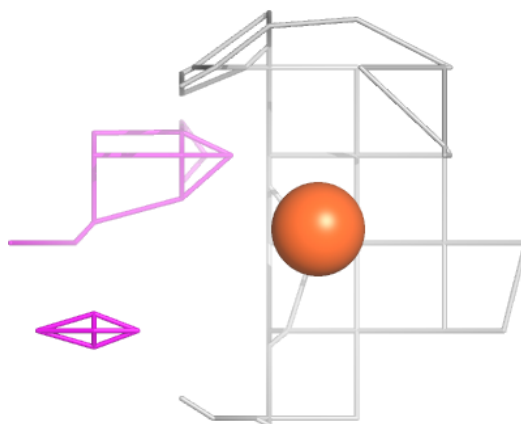
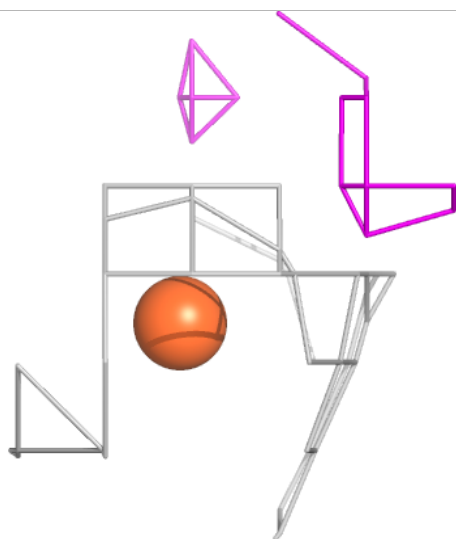
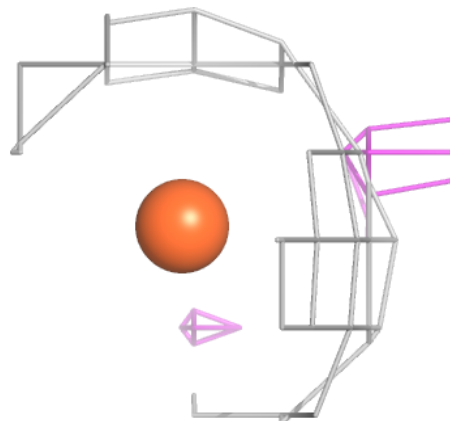



**Electron density around FE C 401:**

$2mF_o-DF_c$  (at 0.7 rmsd) in gray  
 $mF_o-DF_c$  (at 3 rmsd) in purple (negative)  
and green (positive)

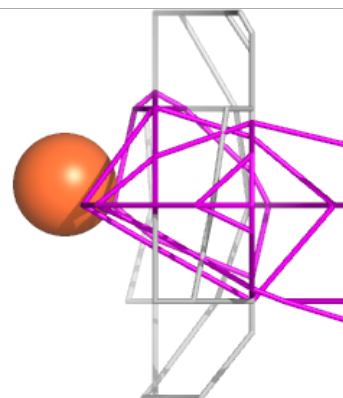
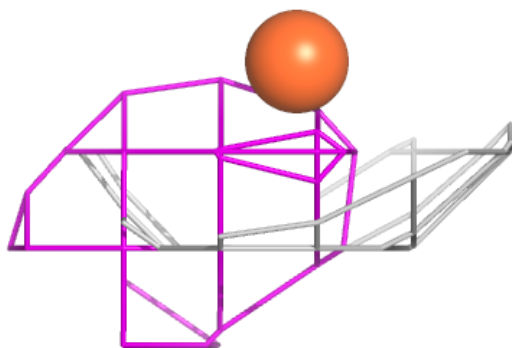
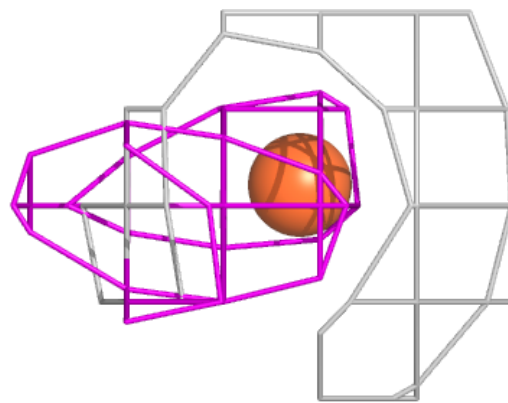

**Electron density around FES I 402:**

$2mF_o-DF_c$  (at 0.7 rmsd) in gray  
 $mF_o-DF_c$  (at 3 rmsd) in purple (negative)  
and green (positive)

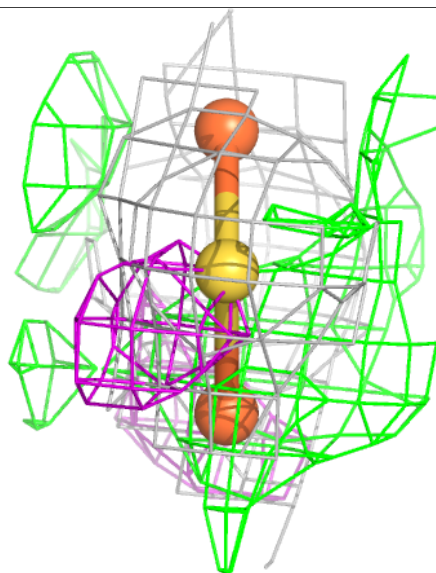
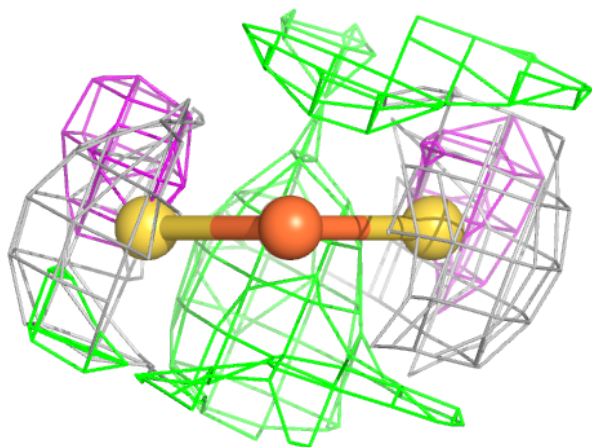
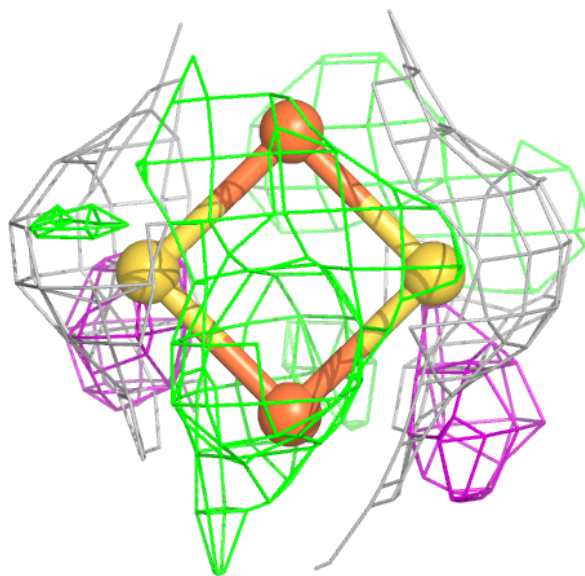

**Electron density around FES C 402:**

$2mF_o-DF_c$  (at 0.7 rmsd) in gray  
 $mF_o-DF_c$  (at 3 rmsd) in purple (negative)  
and green (positive)

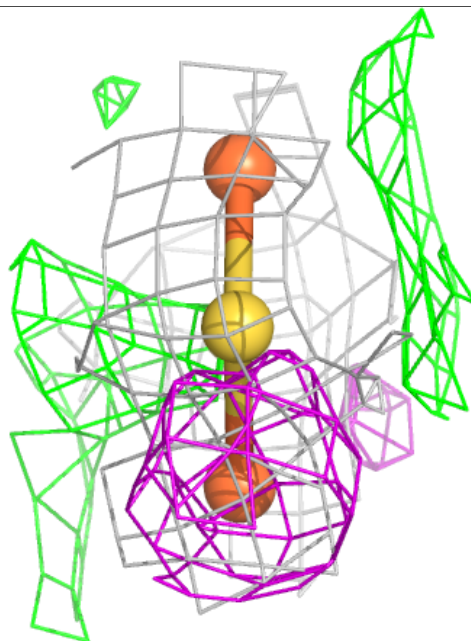
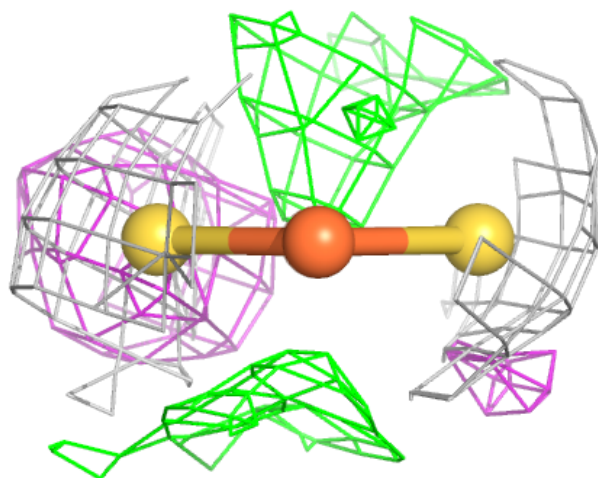
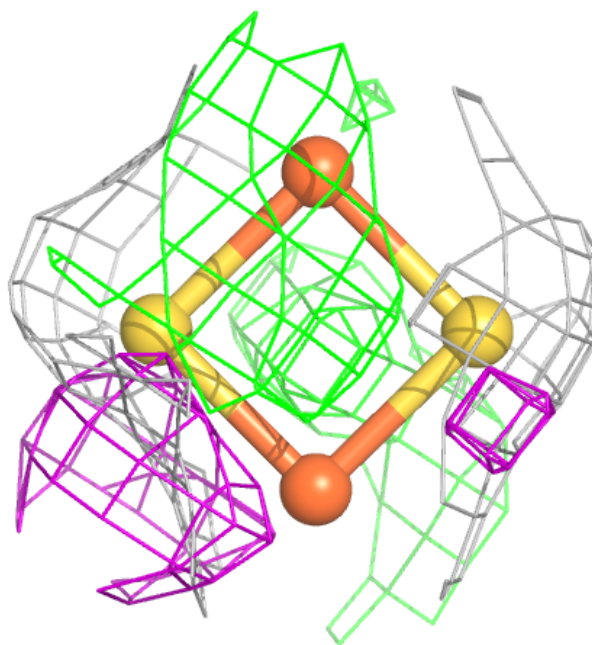

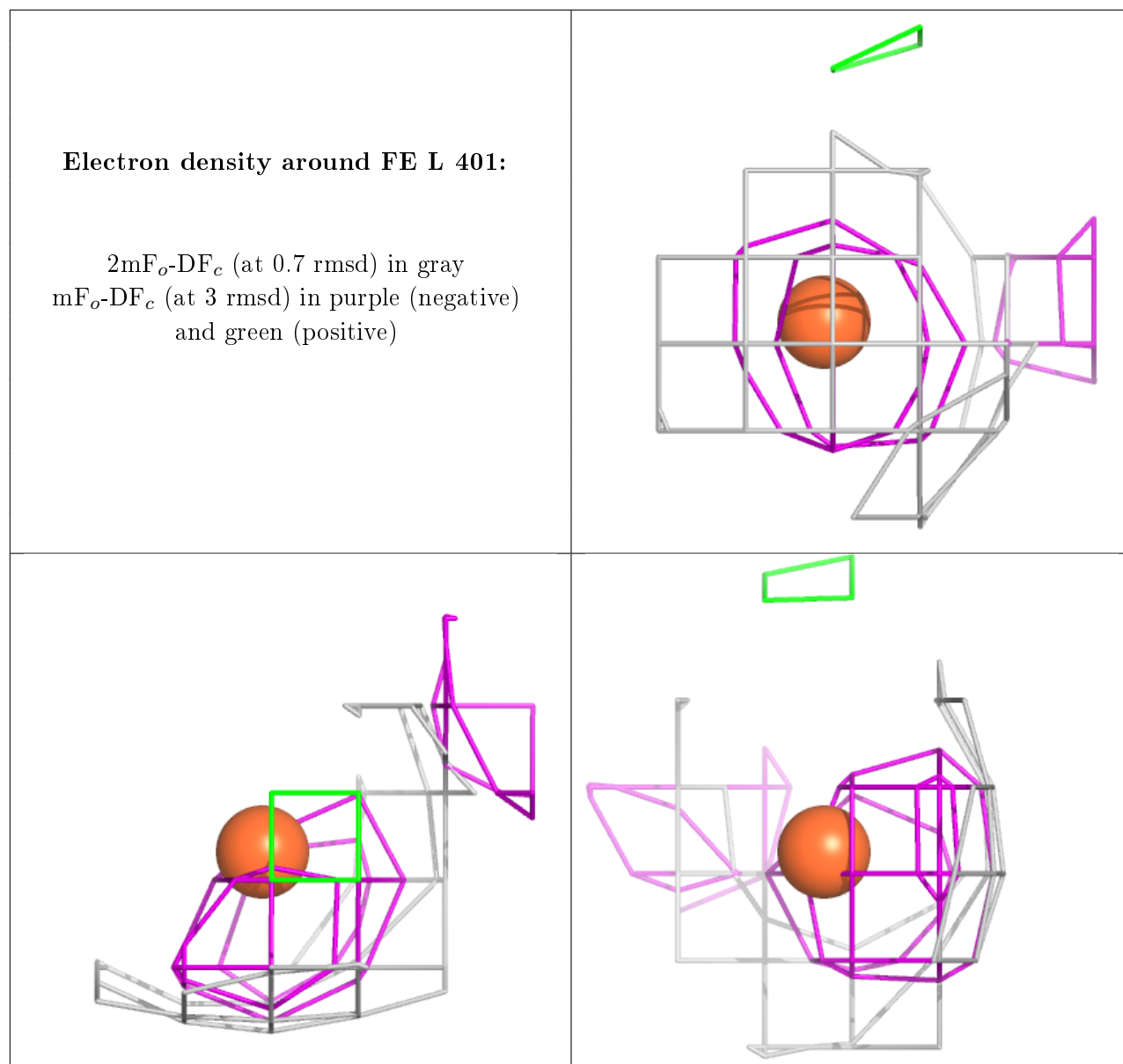

**Electron density around FES B 402:**

$2mF_o-DF_c$  (at 0.7 rmsd) in gray  
 $mF_o-DF_c$  (at 3 rmsd) in purple (negative)  
and green (positive)

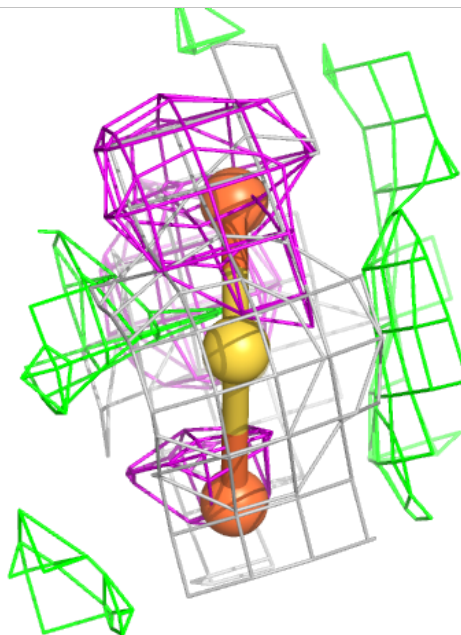
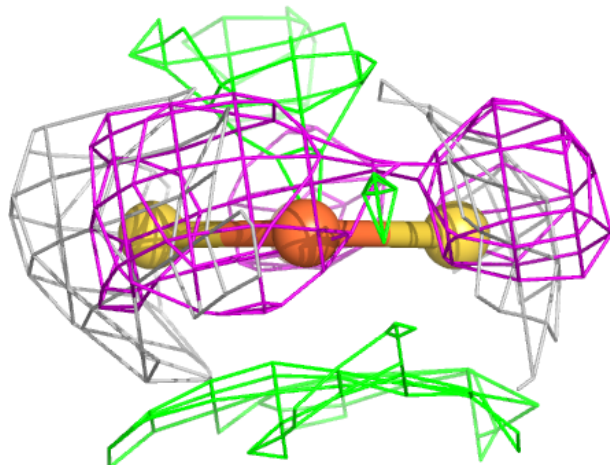
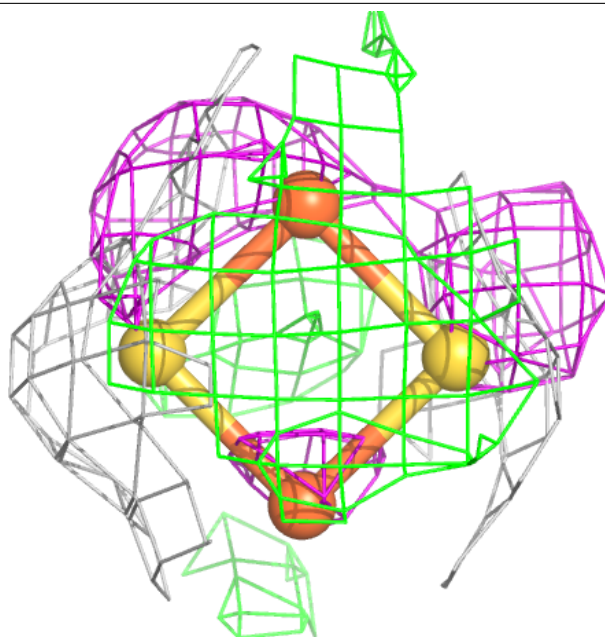

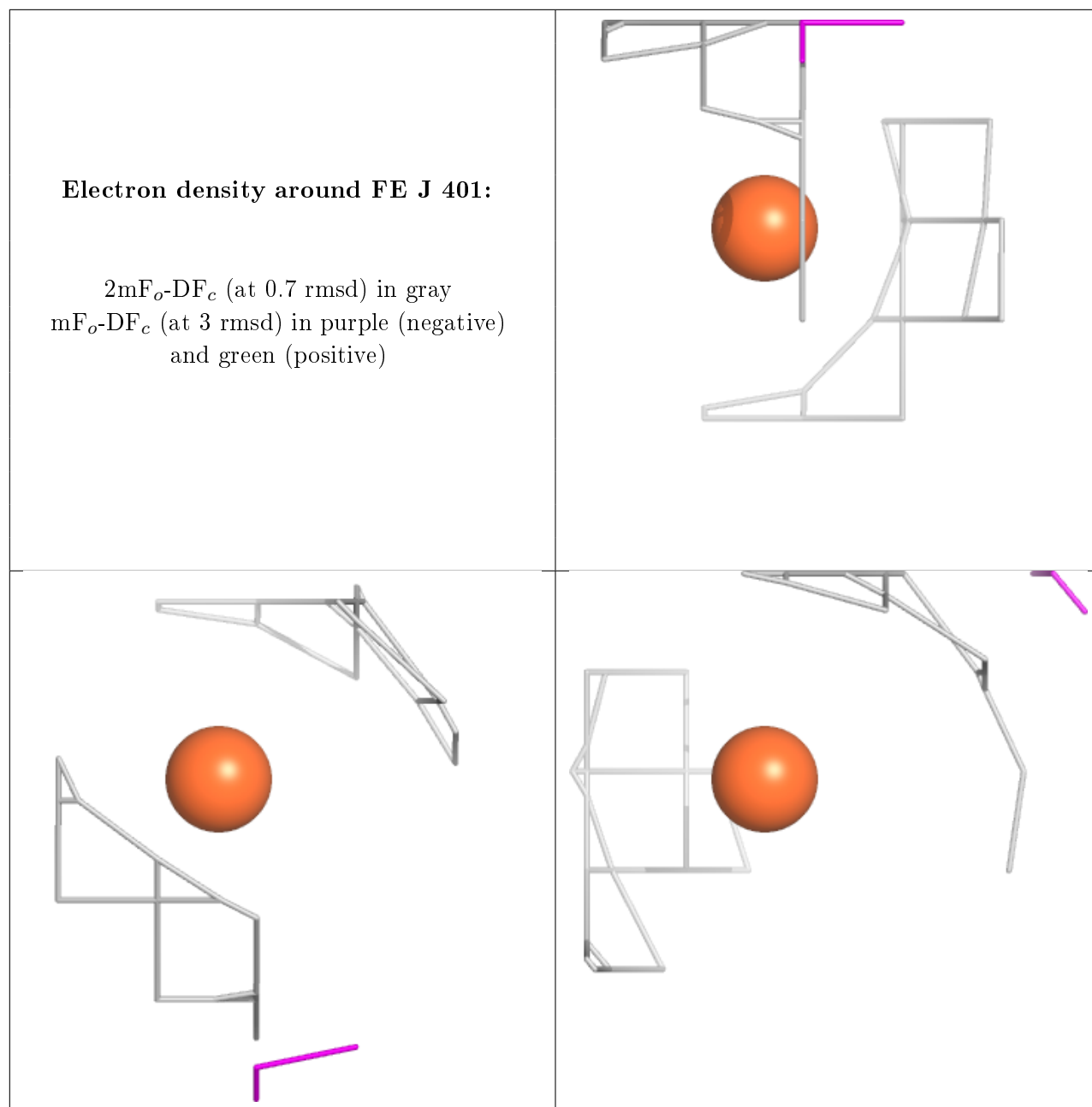

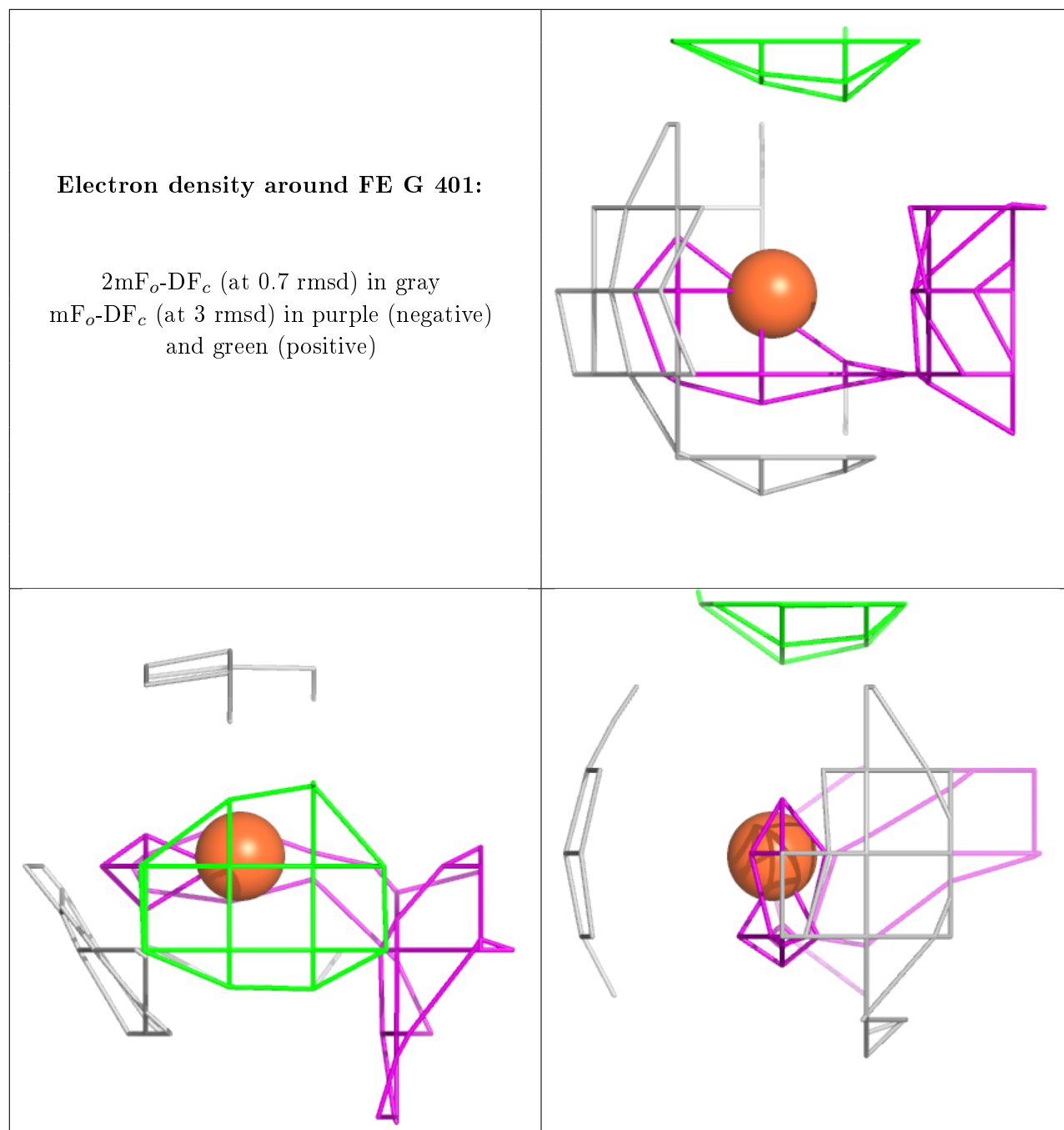

## 6.5 Other polymers [\(i\)](#)

There are no such residues in this entry.