



Full wwPDB X-ray Structure Validation Report ⓘ

Mar 3, 2024 – 10:46 PM EST

PDB ID : 6O5M
Title : Tubulin-RB3_SLD-TTL in complex with compound 10bb
Authors : Kumar, G.; Wang, Y.; Li, W.; White, S.W.
Deposited on : 2019-03-04
Resolution : 2.30 Å(reported)

This is a Full wwPDB X-ray Structure Validation Report for a publicly released PDB entry.

We welcome your comments at validation@mail.wwpdb.org

A user guide is available at

<https://www.wwpdb.org/validation/2017/XrayValidationReportHelp>

with specific help available everywhere you see the ⓘ symbol.

The types of validation reports are described at

<http://www.wwpdb.org/validation/2017/FAQs#types>.

The following versions of software and data (see [references ⓘ](#)) were used in the production of this report:

MolProbity : 4.02b-467
Mogul : 1.8.5 (274361), CSD as541be (2020)
Xtriage (Phenix) : 1.13
EDS : 2.36
buster-report : 1.1.7 (2018)
Percentile statistics : 20191225.v01 (using entries in the PDB archive December 25th 2019)
Refmac : 5.8.0158
CCP4 : 7.0.044 (Gargrove)
Ideal geometry (proteins) : Engh & Huber (2001)
Ideal geometry (DNA, RNA) : Parkinson et al. (1996)
Validation Pipeline (wwPDB-VP) : 2.36

1 Overall quality at a glance

The following experimental techniques were used to determine the structure:

X-RAY DIFFRACTION

The reported resolution of this entry is 2.30 Å.

Percentile scores (ranging between 0-100) for global validation metrics of the entry are shown in the following graphic. The table shows the number of entries on which the scores are based.

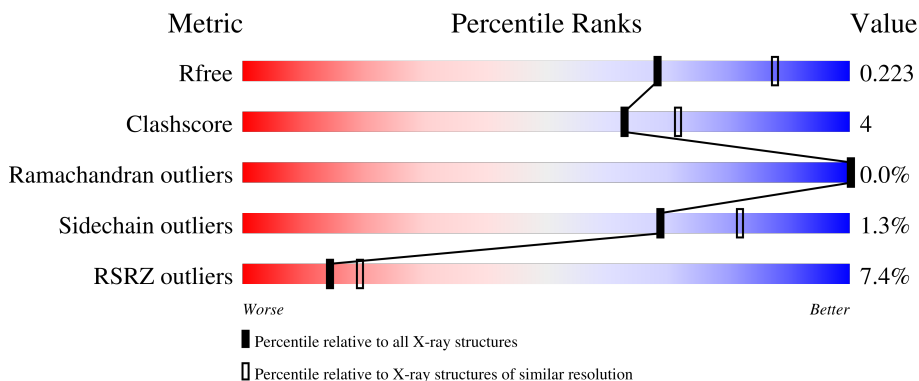

Metric	Whole archive (#Entries)	Similar resolution (#Entries, resolution range(Å))
R_{free}	130704	5042 (2.30-2.30)
Clashscore	141614	5643 (2.30-2.30)
Ramachandran outliers	138981	5575 (2.30-2.30)
Sidechain outliers	138945	5575 (2.30-2.30)
RSRZ outliers	127900	4938 (2.30-2.30)

The table below summarises the geometric issues observed across the polymeric chains and their fit to the electron density. The red, orange, yellow and green segments of the lower bar indicate the fraction of residues that contain outliers for ≥ 3 , 2, 1 and 0 types of geometric quality criteria respectively. A grey segment represents the fraction of residues that are not modelled. The numeric value for each fraction is indicated below the corresponding segment, with a dot representing fractions $\leq 5\%$. The upper red bar (where present) indicates the fraction of residues that have poor fit to the electron density. The numeric value is given above the bar.

Mol	Chain	Length	Quality of chain
1	A	450	 89% 8% .
1	C	450	 90% 7% ..
2	B	445	 87% 9% .
2	D	445	 80% 13% . 5%
3	E	143	 72% 12% 16%

Continued on next page...

Continued from previous page...

Mol	Chain	Length	Quality of chain
4	F	384	 <p>A horizontal bar chart representing the quality of chain. The bar is divided into four segments: a red segment on the left labeled '26%', a large green segment labeled '72%', a small yellow segment labeled '11%', and a grey segment on the far right labeled '15%'.</p>

2 Entry composition i

There are 13 unique types of molecules in this entry. The entry contains 17881 atoms, of which 0 are hydrogens and 0 are deuteriums.

In the tables below, the ZeroOcc column contains the number of atoms modelled with zero occupancy, the AltConf column contains the number of residues with at least one atom in alternate conformation and the Trace column contains the number of residues modelled with at most 2 atoms.

- Molecule 1 is a protein called Tubulin alpha-1B chain.

Mol	Chain	Residues	Atoms					ZeroOcc	AltConf	Trace
			Total	C	N	O	S			
1	A	437	Total	C	N	O	S	0	1	0
			3376	2137	576	640	23			
1	C	440	Total	C	N	O	S	0	1	0
			3432	2173	583	653	23			

- Molecule 2 is a protein called Tubulin beta-2B chain.

Mol	Chain	Residues	Atoms					ZeroOcc	AltConf	Trace
			Total	C	N	O	S			
2	B	427	Total	C	N	O	S	0	0	0
			3328	2092	569	642	25			
2	D	421	Total	C	N	O	S	0	1	0
			3255	2049	550	631	25			

- Molecule 3 is a protein called Stathmin-4.

Mol	Chain	Residues	Atoms					ZeroOcc	AltConf	Trace
			Total	C	N	O	S			
3	E	120	Total	C	N	O	S	0	1	0
			978	604	179	190	5			

There are 2 discrepancies between the modelled and reference sequences:

Chain	Residue	Modelled	Actual	Comment	Reference
E	3	MET	-	expression tag	UNP Q9H169
E	4	ALA	-	expression tag	UNP Q9H169

- Molecule 4 is a protein called Tubulin Tyrosine Ligase.

Mol	Chain	Residues	Atoms					ZeroOcc	AltConf	Trace
			Total	C	N	O	S			
4	F	327	Total	C	N	O	S	0	0	0
			2491	1604	421	453	13			

There are 6 discrepancies between the modelled and reference sequences:

Chain	Residue	Modelled	Actual	Comment	Reference
F	379	HIS	-	expression tag	UNP E1BQ43
F	380	HIS	-	expression tag	UNP E1BQ43
F	381	HIS	-	expression tag	UNP E1BQ43
F	382	HIS	-	expression tag	UNP E1BQ43
F	383	HIS	-	expression tag	UNP E1BQ43
F	384	HIS	-	expression tag	UNP E1BQ43

- Molecule 5 is GUANOSINE-5'-TRIPHOSPHATE (three-letter code: GTP) (formula: $C_{10}H_{16}N_5O_{14}P_3$).



Mol	Chain	Residues	Atoms					ZeroOcc	AltConf
			Total	C	N	O	P		
5	A	1	Total	C	N	O	P	0	0
			32	10	5	14	3		
5	C	1	Total	C	N	O	P	0	0
			32	10	5	14	3		
5	D	1	Total	C	N	O	P	0	0
			32	10	5	14	3		

- Molecule 6 is CALCIUM ION (three-letter code: CA) (formula: Ca).

Mol	Chain	Residues	Atoms		ZeroOcc	AltConf
			Total	Ca		
6	A	1	Total	Ca	0	0
			1	1		
6	C	1	Total	Ca	0	0
			1	1		

- Molecule 7 is MAGNESIUM ION (three-letter code: MG) (formula: Mg).

Mol	Chain	Residues	Atoms	ZeroOcc	AltConf
7	A	1	Total Mg 1 1	0	0
7	B	1	Total Mg 1 1	0	0
7	C	1	Total Mg 1 1	0	0
7	F	1	Total Mg 1 1	0	0

- Molecule 8 is GLYCEROL (three-letter code: GOL) (formula: C₃H₈O₃).

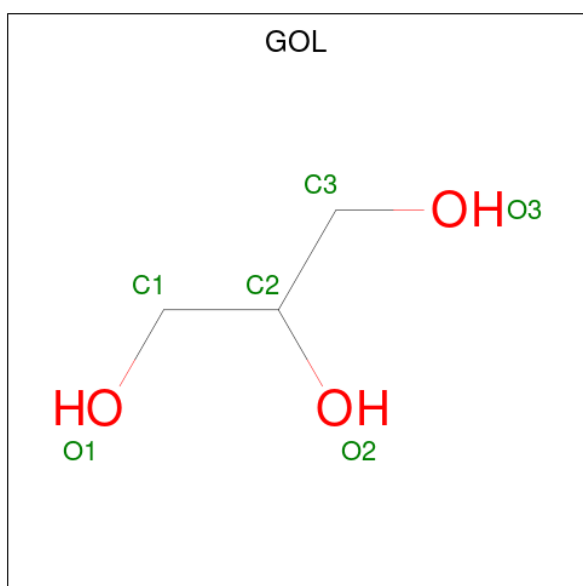

Mol	Chain	Residues	Atoms	ZeroOcc	AltConf
8	A	1	Total C O 6 3 3	0	0
8	B	1	Total C O 6 3 3	0	0

- Molecule 9 is GUANOSINE-5'-DIPHOSPHATE (three-letter code: GDP) (formula: C₁₀H₁₅N₅O₁₁P₂).



Mol	Chain	Residues	Atoms					ZeroOcc	AltConf
			Total	C	N	O	P		
9	B	1	28	10	5	11	2	0	0

- Molecule 10 is 2-(N-MORPHOLINO)-ETHANESULFONIC ACID (three-letter code: MES) (formula: $C_6H_{13}NO_4S$).

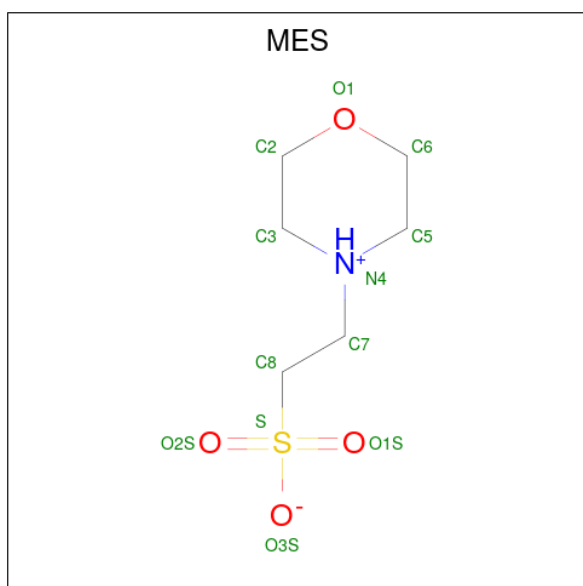

Mol	Chain	Residues	Atoms					ZeroOcc	AltConf
			Total	C	N	O	S		
10	B	1	12	6	1	4	1	0	0
10	B	1	12	6	1	4	1	0	0

- Molecule 11 is [2-(1H-indol-4-yl)-1H-imidazol-4-yl](3,4,5-trimethoxyphenyl)methanone (three-letter code: G8K) (formula: $C_{21}H_{19}N_3O_4$) (labeled as "Ligand of Interest" by depositor).

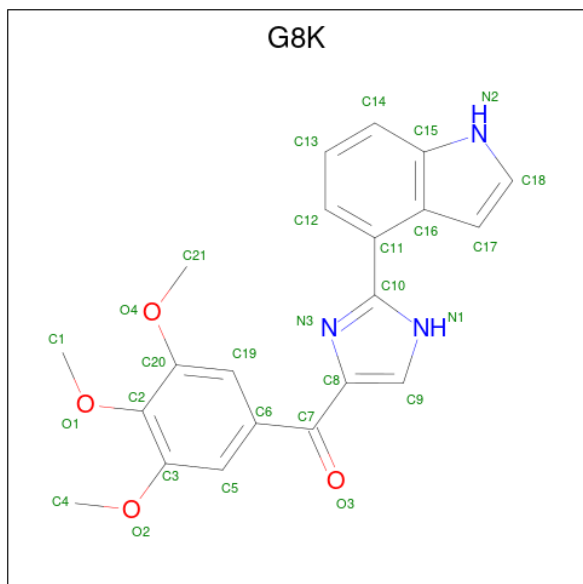

Mol	Chain	Residues	Atoms				ZeroOcc	AltConf
			Total	C	N	O		
11	B	1	Total	C	N	O	0	0
			28	21	3	4		
11	D	1	Total	C	N	O	0	0
			28	21	3	4		

- Molecule 12 is PHOSPHOMETHYLPHOSPHONIC ACID ADENYLATE ESTER (three-letter code: ACP) (formula: $C_{11}H_{18}N_5O_{12}P_3$).

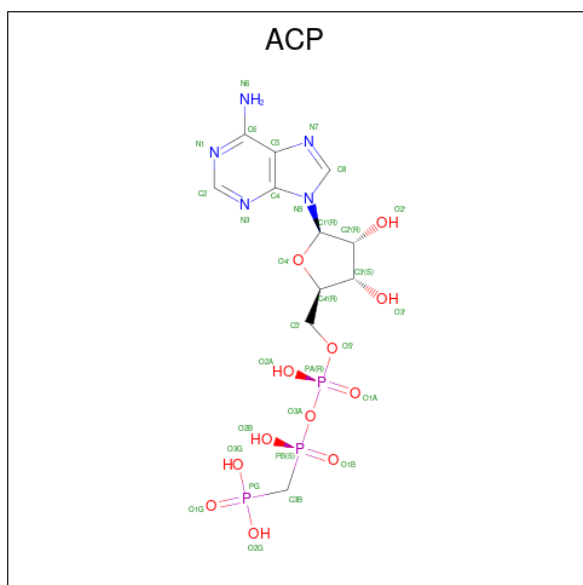

Mol	Chain	Residues	Atoms					ZeroOcc	AltConf
			Total	C	N	O	P		
12	F	1	31	11	5	12	3	0	0

- Molecule 13 is water.

Mol	Chain	Residues	Atoms		ZeroOcc	AltConf
13	A	204	Total 204	O 204	0	0
13	B	131	Total 131	O 131	0	0
13	C	262	Total 262	O 262	0	0
13	D	77	Total 77	O 77	0	0
13	E	40	Total 40	O 40	0	0
13	F	54	Total 54	O 54	0	0

3 Residue-property plots [i](#)

These plots are drawn for all protein, RNA, DNA and oligosaccharide chains in the entry. The first graphic for a chain summarises the proportions of the various outlier classes displayed in the second graphic. The second graphic shows the sequence view annotated by issues in geometry and electron density. Residues are color-coded according to the number of geometric quality criteria for which they contain at least one outlier: green = 0, yellow = 1, orange = 2 and red = 3 or more. A red dot above a residue indicates a poor fit to the electron density ($RSRZ > 2$). Stretches of 2 or more consecutive residues without any outlier are shown as a green connector. Residues present in the sample, but not in the model, are shown in grey.

- Molecule 1: Tubulin alpha-1B chain

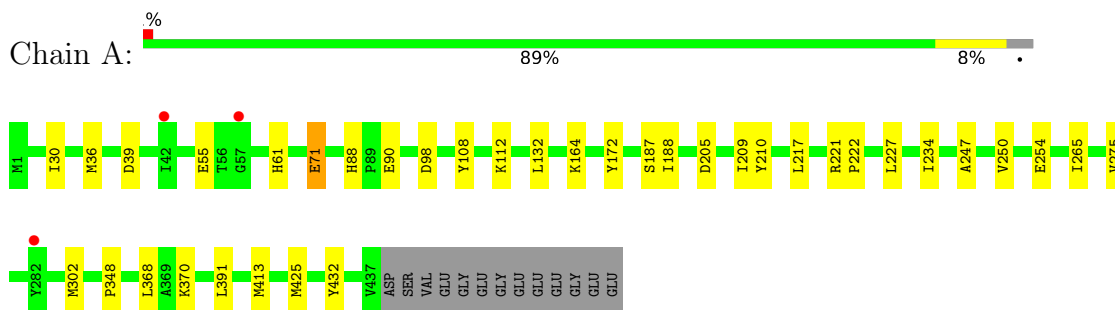

- Molecule 1: Tubulin alpha-1B chain

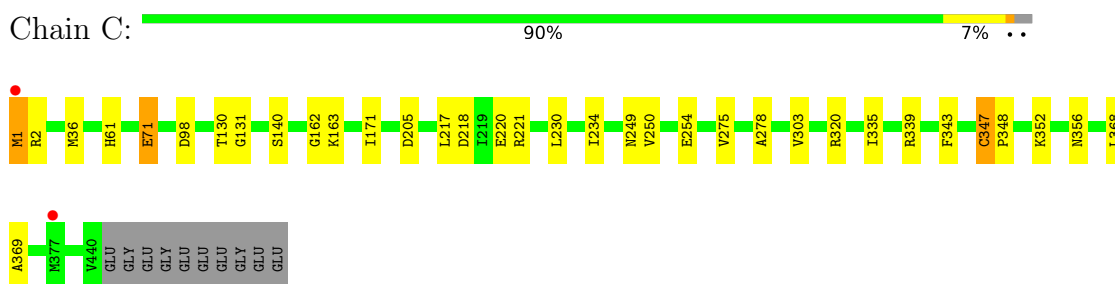

- Molecule 2: Tubulin beta-2B chain

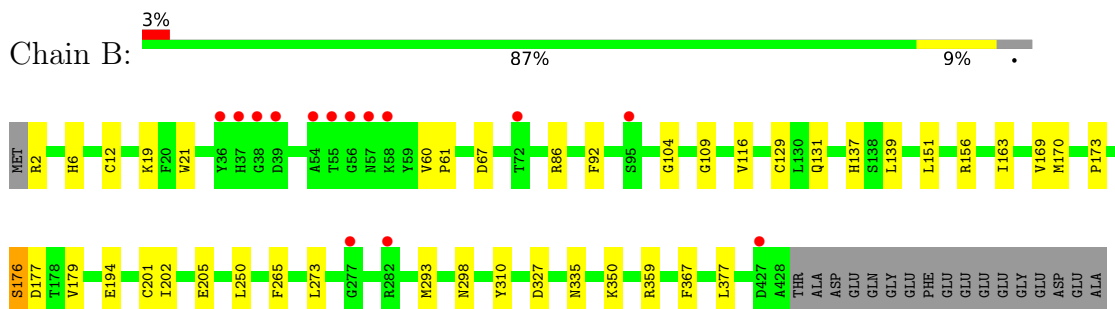

- Molecule 2: Tubulin beta-2B chain

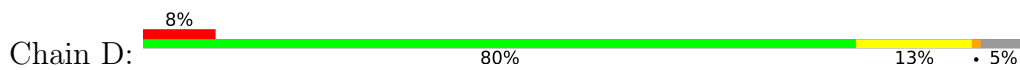

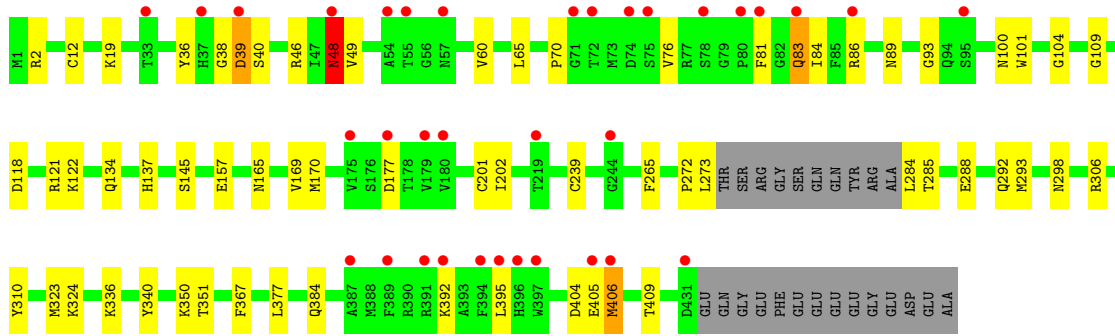

● Molecule 3: Stathmin-4

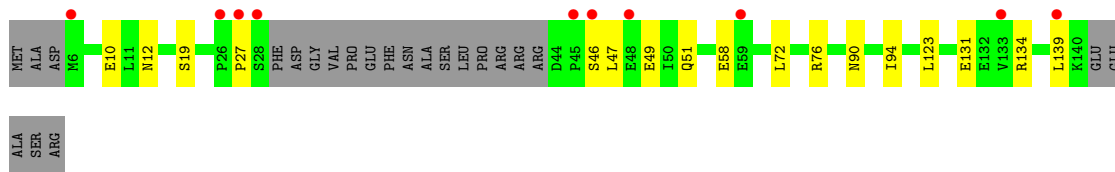
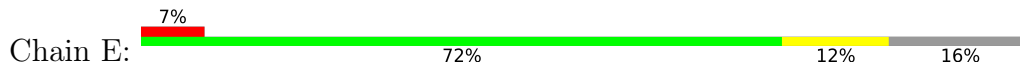

● Molecule 4: Tubulin Tyrosine Ligase

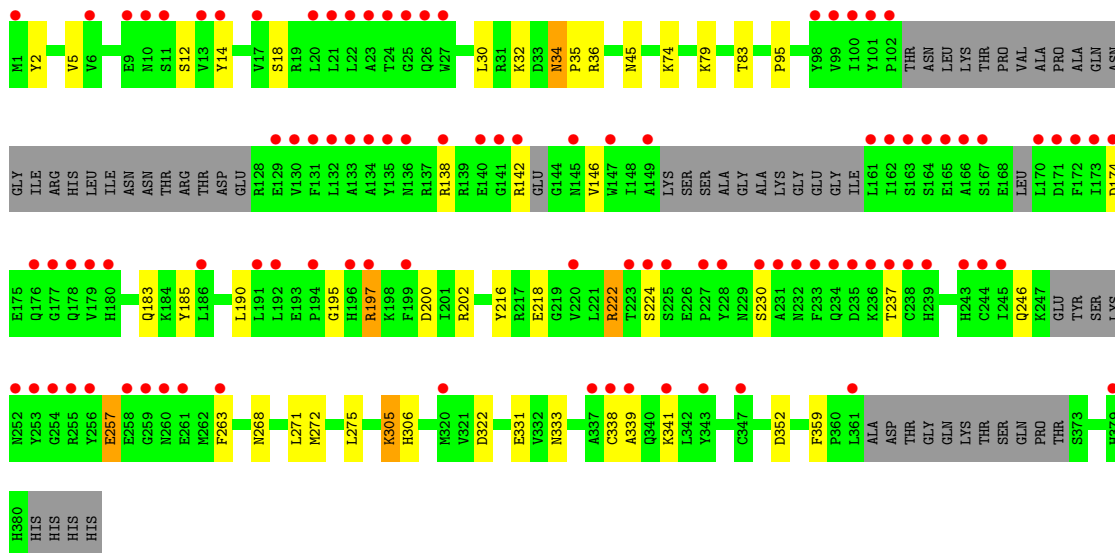
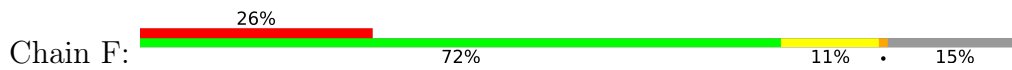

4 Data and refinement statistics

Property	Value	Source
Space group	P 21 21 21	Depositor
Cell constants a, b, c, α , β , γ	104.97Å 157.72Å 181.62Å 90.00° 90.00° 90.00°	Depositor
Resolution (Å)	49.76 – 2.30 49.76 – 2.29	Depositor EDS
% Data completeness (in resolution range)	99.2 (49.76-2.30) 99.2 (49.76-2.29)	Depositor EDS
R_{merge}	0.11	Depositor
R_{sym}	(Not available)	Depositor
$\langle I/\sigma(I) \rangle$ ¹	2.57 (at 2.29Å)	Xtrriage
Refinement program	PHENIX (1.13_2998: ???)	Depositor
R, R_{free}	0.190 , 0.223 0.190 , 0.223	Depositor DCC
R_{free} test set	7667 reflections (5.67%)	wwPDB-VP
Wilson B-factor (Å ²)	29.8	Xtrriage
Anisotropy	0.026	Xtrriage
Bulk solvent k_{sol} (e/Å ³), B_{sol} (Å ²)	0.32 , 45.7	EDS
L-test for twinning ²	$\langle L \rangle = 0.50$, $\langle L^2 \rangle = 0.33$	Xtrriage
Estimated twinning fraction	No twinning to report.	Xtrriage
F_o, F_c correlation	0.94	EDS
Total number of atoms	17881	wwPDB-VP
Average B, all atoms (Å ²)	43.0	wwPDB-VP

Xtrriage's analysis on translational NCS is as follows: *The largest off-origin peak in the Patterson function is 2.56% of the height of the origin peak. No significant pseudotranslation is detected.*

¹Intensities estimated from amplitudes.

²Theoretical values of $\langle |L| \rangle$, $\langle L^2 \rangle$ for acentric reflections are 0.5, 0.333 respectively for untwinned datasets, and 0.375, 0.2 for perfectly twinned datasets.

5 Model quality i

5.1 Standard geometry i

Bond lengths and bond angles in the following residue types are not validated in this section: GOL, GDP, GTP, MES, CA, G8K, MG, ACP

The Z score for a bond length (or angle) is the number of standard deviations the observed value is removed from the expected value. A bond length (or angle) with $|Z| > 5$ is considered an outlier worth inspection. RMSZ is the root-mean-square of all Z scores of the bond lengths (or angles).

Mol	Chain	Bond lengths		Bond angles	
		RMSZ	# Z >5	RMSZ	# Z >5
1	A	0.25	0/3456	0.44	0/4699
1	C	0.26	0/3513	0.45	0/4771
2	B	0.25	0/3403	0.43	0/4615
2	D	0.32	1/3330 (0.0%)	0.59	6/4520 (0.1%)
3	E	0.24	0/990	0.39	1/1318 (0.1%)
4	F	0.26	0/2547	0.43	0/3457
All	All	0.27	1/17239 (0.0%)	0.47	7/23380 (0.0%)

Chiral center outliers are detected by calculating the chiral volume of a chiral center and verifying if the center is modelled as a planar moiety or with the opposite hand. A planarity outlier is detected by checking planarity of atoms in a peptide group, atoms in a mainchain group or atoms of a sidechain that are expected to be planar.

Mol	Chain	#Chirality outliers	#Planarity outliers
2	D	0	1

All (1) bond length outliers are listed below:

Mol	Chain	Res	Type	Atoms	Z	Observed(Å)	Ideal(Å)
2	D	83	GLN	CG-CD	-6.18	1.36	1.51

All (7) bond angle outliers are listed below:

Mol	Chain	Res	Type	Atoms	Z	Observed(°)	Ideal(°)
2	D	83	GLN	CA-CB-CG	12.19	140.21	113.40
2	D	48	ASN	CB-CA-C	-8.28	93.83	110.40
2	D	406	MET	CA-CB-CG	7.28	125.67	113.30
2	D	83	GLN	CB-CA-C	6.34	123.07	110.40
2	D	83	GLN	N-CA-CB	-6.08	99.67	110.60
2	D	406	MET	CB-CG-SD	-5.38	96.26	112.40

Continued on next page...

Continued from previous page...

Mol	Chain	Res	Type	Atoms	Z	Observed(°)	Ideal(°)
3	E	139	LEU	CA-CB-CG	5.16	127.18	115.30

There are no chirality outliers.

All (1) planarity outliers are listed below:

Mol	Chain	Res	Type	Group
2	D	83	GLN	Sidechain

5.2 Too-close contacts [i](#)

In the following table, the Non-H and H(model) columns list the number of non-hydrogen atoms and hydrogen atoms in the chain respectively. The H(added) column lists the number of hydrogen atoms added and optimized by MolProbity. The Clashes column lists the number of clashes within the asymmetric unit, whereas Symm-Clashes lists symmetry-related clashes.

Mol	Chain	Non-H	H(model)	H(added)	Clashes	Symm-Clashes
1	A	3376	0	3262	23	0
1	C	3432	0	3343	24	0
2	B	3328	0	3177	28	0
2	D	3255	0	3087	42	0
3	E	978	0	978	11	0
4	F	2491	0	2288	27	0
5	A	32	0	12	1	0
5	C	32	0	12	0	0
5	D	32	0	12	1	0
6	A	1	0	0	0	0
6	C	1	0	0	0	0
7	A	1	0	0	0	0
7	B	1	0	0	0	0
7	C	1	0	0	0	0
7	F	1	0	0	0	0
8	A	6	0	8	1	0
8	B	6	0	8	0	0
9	B	28	0	12	1	0
10	B	24	0	24	1	0
11	B	28	0	0	1	0
11	D	28	0	0	1	0
12	F	31	0	13	0	0
13	A	204	0	0	0	0
13	B	131	0	0	0	0
13	C	262	0	0	0	0

Continued on next page...

Continued from previous page...

Mol	Chain	Non-H	H(model)	H(added)	Clashes	Symm-Clashes
13	D	77	0	0	1	0
13	E	40	0	0	0	0
13	F	54	0	0	0	0
All	All	17881	0	16236	143	0

The all-atom clashscore is defined as the number of clashes found per 1000 atoms (including hydrogen atoms). The all-atom clashscore for this structure is 4.

All (143) close contacts within the same asymmetric unit are listed below, sorted by their clash magnitude.

Atom-1	Atom-2	Interatomic distance (Å)	Clash overlap (Å)
2:D:39:ASP:OD1	2:D:40:SER:N	2.03	0.92
4:F:5:VAL:HG13	4:F:32:LYS:HA	1.59	0.85
2:B:173:PRO:HA	2:B:176:SER:HB2	1.64	0.79
2:B:293:MET:HE2	2:B:367:PHE:HB2	1.69	0.75
2:D:170:MET:HG3	2:D:377:LEU:HD11	1.69	0.74
2:B:116:VAL:HG11	2:B:151:LEU:HD11	1.73	0.68
2:B:170:MET:HG3	2:B:377:LEU:HD11	1.77	0.64
1:A:221:ARG:NH1	2:B:327:ASP:OD2	2.25	0.63
1:A:112:LYS:NZ	3:E:58:GLU:OE1	2.31	0.62
1:C:221:ARG:HG3	2:D:323:MET:HG2	1.79	0.62
1:A:234:ILE:HD13	1:A:302:MET:SD	2.39	0.62
4:F:305:LYS:HD2	4:F:306:HIS:H	1.64	0.61
2:D:36:TYR:CZ	2:D:38:GLY:HA3	2.35	0.61
1:C:162:GLY:HA2	3:E:94:ILE:HD11	1.83	0.61
2:D:350:LYS:HD2	2:D:351:THR:H	1.66	0.60
2:D:392:LYS:HE3	2:D:405:GLU:OE1	2.00	0.60
4:F:331:GLU:OE1	4:F:333:ASN:ND2	2.28	0.59
4:F:202:ARG:NH2	4:F:333:ASN:OD1	2.34	0.59
2:D:46:ARG:NH2	2:D:239:CYS:O	2.35	0.58
4:F:263:PHE:CE2	4:F:341:LYS:HD3	2.39	0.58
1:C:250:VAL:HG11	1:C:352:LYS:HE3	1.86	0.58
4:F:34:ASN:HD22	4:F:35:PRO:HD2	1.70	0.57
2:D:60:VAL:HG11	2:D:86:ARG:HG3	1.86	0.56
2:D:384:GLN:NE2	13:D:604:HOH:O	2.37	0.56
4:F:146:VAL:HG13	4:F:185:TYR:HB3	1.88	0.56
4:F:200:ASP:OD1	4:F:222:ARG:HB2	2.07	0.55
2:D:272:PRO:HB3	2:D:284:LEU:HD11	1.89	0.54
1:C:71:GLU:HG2	1:C:98:ASP:HB3	1.89	0.54
4:F:197:ARG:NH1	4:F:257:GLU:OE2	2.38	0.54
1:C:278:ALA:HA	1:C:369:ALA:HB2	1.89	0.54

Continued on next page...

Continued from previous page...

Atom-1	Atom-2	Interatomic distance (Å)	Clash overlap (Å)
2:D:118:ASP:OD1	2:D:121:ARG:NH1	2.40	0.54
4:F:271:LEU:HD23	4:F:275:LEU:HD12	1.90	0.53
2:D:86:ARG:NH1	2:D:89:ASN:OD1	2.42	0.53
2:B:2:ARG:HE	2:B:131:GLN:HG2	1.73	0.53
4:F:30:LEU:HD13	4:F:34:ASN:OD1	2.09	0.53
2:B:177:ASP:O	1:C:352:LYS:NZ	2.36	0.53
2:D:350:LYS:HB2	11:D:502:G8K:C15	2.40	0.52
2:D:118:ASP:O	2:D:122:LYS:HD2	2.10	0.51
1:A:217:LEU:HD21	1:A:368:LEU:HD23	1.92	0.51
1:C:220:GLU:CG	2:D:324:LYS:HD2	2.41	0.51
1:A:55:GLU:HG2	1:A:61:HIS:CD2	2.46	0.50
2:D:12:CYS:HB2	5:D:501:GTP:C8	2.47	0.50
2:B:104:GLY:O	2:B:109:GLY:HA3	2.12	0.50
2:D:60:VAL:HG11	2:D:86:ARG:CG	2.41	0.50
1:A:210:TYR:CZ	1:A:222:PRO:HD2	2.47	0.50
1:A:209:ILE:HD11	1:A:302:MET:SD	2.52	0.50
2:B:170:MET:HE2	2:B:377:LEU:HD21	1.93	0.50
1:C:2:ARG:HA	1:C:131:GLY:O	2.12	0.49
3:E:10:GLU:O	3:E:12:ASN:ND2	2.46	0.49
1:C:275:VAL:HG13	1:C:368:LEU:HD21	1.95	0.49
2:B:273:LEU:HD11	2:B:298:ASN:HA	1.94	0.49
1:C:254:GLU:HG2	1:C:352:LYS:HE2	1.94	0.49
1:C:320:ARG:HA	1:C:356:ASN:O	2.13	0.48
2:D:392:LYS:HG2	2:D:395:LEU:HD12	1.95	0.48
2:D:169:VAL:HA	2:D:202:ILE:O	2.12	0.48
1:C:335:ILE:HG23	1:C:339:ARG:HG3	1.94	0.48
2:D:134:GLN:HA	2:D:165:ASN:O	2.13	0.48
1:C:343:PHE:HD2	1:C:347[A]:CYS:SG	2.37	0.48
4:F:5:VAL:CG1	4:F:32:LYS:HA	2.38	0.48
1:C:230:LEU:O	1:C:234:ILE:HD12	2.14	0.48
2:B:6:HIS:CD2	2:B:21:TRP:HE1	2.31	0.48
1:A:108:TYR:CE2	1:A:413:MET:HG3	2.48	0.47
1:A:71:GLU:HG2	1:A:98:ASP:HB3	1.96	0.47
3:E:72:LEU:O	3:E:76:ARG:HG2	2.15	0.47
4:F:2:TYR:CE1	4:F:359:PHE:HB3	2.50	0.47
4:F:237:THR:O	4:F:246:GLN:NE2	2.47	0.47
1:A:187:SER:HB3	1:A:391:LEU:HD21	1.97	0.46
1:A:348:PRO:HB3	3:E:27:PRO:HD3	1.97	0.46
2:D:404:ASP:OD1	2:D:405:GLU:N	2.48	0.46
4:F:195:GLY:HA3	4:F:197:ARG:HD2	1.97	0.46
1:A:98:ASP:HB2	5:A:501:GTP:O3G	2.16	0.46

Continued on next page...

Continued from previous page...

Atom-1	Atom-2	Interatomic distance (Å)	Clash overlap (Å)
1:A:247:ALA:HB3	3:E:19:SER:OG	2.16	0.46
2:B:2:ARG:NE	2:B:131:GLN:HG2	2.30	0.46
2:D:19:LYS:HB3	2:D:19:LYS:HE3	1.68	0.46
2:D:306:ARG:HG2	2:D:340:TYR:CZ	2.51	0.46
4:F:14:TYR:O	4:F:18:SER:OG	2.32	0.45
2:B:12:CYS:HB2	9:B:501:GDP:C8	2.50	0.45
2:B:19:LYS:HB3	2:B:19:LYS:HE3	1.64	0.45
2:B:169:VAL:HA	2:B:202:ILE:O	2.17	0.45
1:C:36:MET:HB3	1:C:61:HIS:CE1	2.51	0.45
2:D:288:GLU:O	2:D:292:GLN:HG3	2.17	0.45
1:C:217:LEU:HD21	1:C:368:LEU:HD23	1.99	0.45
4:F:79:LYS:O	4:F:83:THR:HG23	2.17	0.45
2:D:48:ASN:OD1	2:D:49:VAL:HG23	2.18	0.44
2:D:101:TRP:HD1	2:D:145:SER:OG	1.99	0.44
1:A:188:ILE:HD12	1:A:425:MET:HG3	2.00	0.44
10:B:503:MES:H51	10:B:503:MES:H81	1.60	0.44
2:D:81:PHE:O	2:D:84:ILE:HG22	2.17	0.44
4:F:268:ASN:O	4:F:272:MET:HG3	2.17	0.44
2:B:310:TYR:CE1	2:B:367:PHE:HZ	2.36	0.44
2:D:65:LEU:HD22	2:D:76:VAL:HG11	1.99	0.44
4:F:338:CYS:SG	4:F:339:ALA:N	2.91	0.44
2:B:67:ASP:O	2:B:92:PHE:HA	2.17	0.43
2:D:39:ASP:CG	2:D:40:SER:N	2.69	0.43
1:C:140:SER:HA	1:C:171:ILE:HB	2.00	0.43
1:A:209:ILE:HG22	1:A:227:LEU:HD22	2.00	0.43
1:C:249:ASN:OD1	1:C:356:ASN:ND2	2.50	0.43
1:A:30:ILE:HG12	1:A:36:MET:HB2	2.00	0.43
1:C:205:ASP:CB	1:C:303:VAL:HA	2.48	0.43
1:A:265:ILE:HG23	1:A:432:TYR:CE1	2.54	0.43
2:D:350:LYS:HD2	2:D:351:THR:N	2.32	0.43
2:B:163:ILE:HG21	2:B:250:LEU:HB3	2.00	0.43
2:B:335:ASN:OD1	4:F:36:ARG:NH2	2.52	0.43
3:E:47:LEU:O	3:E:51:GLN:HG2	2.18	0.43
1:A:88:HIS:CD2	1:A:90:GLU:H	2.37	0.42
2:B:60:VAL:HG11	2:B:86:ARG:HH21	1.84	0.42
2:B:359:ARG:HA	2:B:359:ARG:HD3	1.79	0.42
1:C:1:MET:HG2	1:C:130:THR:OG1	2.19	0.42
4:F:197:ARG:HB3	4:F:224:SER:O	2.19	0.42
1:A:172:TYR:HB3	1:A:205:ASP:HA	2.02	0.42
2:B:2:ARG:HA	2:B:129:CYS:O	2.20	0.42
2:B:21:TRP:CZ3	2:B:61:PRO:HB3	2.55	0.42

Continued on next page...

Continued from previous page...

Atom-1	Atom-2	Interatomic distance (Å)	Clash overlap (Å)
2:B:201:CYS:SG	2:B:265:PHE:HB3	2.59	0.42
4:F:74:LYS:NZ	4:F:331:GLU:OE2	2.50	0.42
1:C:163:LYS:HD2	3:E:90:ASN:HD22	1.85	0.42
2:D:201:CYS:SG	2:D:265:PHE:HB3	2.60	0.42
2:B:350:LYS:HB2	11:B:506:G8K:C15	2.50	0.42
2:D:293:MET:CG	2:D:367:PHE:HB2	2.49	0.42
2:B:179:VAL:HG12	1:C:348:PRO:HG2	2.02	0.42
1:A:275:VAL:N	8:A:504:GOL:O3	2.34	0.41
2:D:273:LEU:HD11	2:D:298:ASN:HA	2.01	0.41
1:A:36:MET:HE3	1:A:39:ASP:HB2	2.03	0.41
1:A:132:LEU:O	1:A:164:LYS:HE3	2.20	0.41
2:D:285:THR:OG1	2:D:288:GLU:HG3	2.20	0.41
2:D:310:TYR:CE1	2:D:367:PHE:HZ	2.39	0.41
4:F:216:TYR:CE1	4:F:218:GLU:HB2	2.56	0.41
2:D:70:PRO:HG3	2:D:93:GLY:O	2.21	0.41
4:F:138:ARG:O	4:F:142:ARG:N	2.54	0.41
2:B:156:ARG:NH1	2:B:194:GLU:O	2.54	0.41
2:D:104:GLY:O	2:D:109:GLY:HA3	2.21	0.41
3:E:46:SER:OG	3:E:49:GLU:HG3	2.20	0.41
3:E:131:GLU:HG2	3:E:134:ARG:HH21	1.86	0.41
2:D:406:MET:HA	2:D:409:THR:OG1	2.20	0.41
1:A:250:VAL:HG22	1:A:254:GLU:OE2	2.21	0.40
2:B:139:LEU:HD12	2:B:170:MET:HE3	2.03	0.40
2:D:2:ARG:HD2	2:D:2:ARG:HA	1.95	0.40
2:D:157:GLU:HG3	3:E:123:LEU:HB3	2.03	0.40
4:F:190:LEU:HB2	4:F:322:ASP:O	2.21	0.40
1:C:220:GLU:HG3	2:D:324:LYS:HD2	2.02	0.40
4:F:95:PRO:HB2	4:F:183:GLN:HG3	2.04	0.40
1:C:205:ASP:HB3	1:C:303:VAL:HA	2.02	0.40
2:D:336:LYS:HB3	2:D:336:LYS:HE2	1.93	0.40
4:F:305:LYS:HD2	4:F:306:HIS:N	2.33	0.40

There are no symmetry-related clashes.

5.3 Torsion angles [i](#)

5.3.1 Protein backbone [i](#)

In the following table, the Percentiles column shows the percent Ramachandran outliers of the chain as a percentile score with respect to all X-ray entries followed by that with respect to entries of similar resolution.

The Analysed column shows the number of residues for which the backbone conformation was analysed, and the total number of residues.

Mol	Chain	Analysed	Favoured	Allowed	Outliers	Percentiles	
1	A	436/450 (97%)	429 (98%)	7 (2%)	0	100	100
1	C	439/450 (98%)	431 (98%)	8 (2%)	0	100	100
2	B	425/445 (96%)	418 (98%)	6 (1%)	1 (0%)	47	58
2	D	418/445 (94%)	412 (99%)	6 (1%)	0	100	100
3	E	117/143 (82%)	116 (99%)	1 (1%)	0	100	100
4	F	313/384 (82%)	303 (97%)	10 (3%)	0	100	100
All	All	2148/2317 (93%)	2109 (98%)	38 (2%)	1 (0%)	100	100

All (1) Ramachandran outliers are listed below:

Mol	Chain	Res	Type
2	B	176	SER

5.3.2 Protein sidechains [i](#)

In the following table, the Percentiles column shows the percent sidechain outliers of the chain as a percentile score with respect to all X-ray entries followed by that with respect to entries of similar resolution.

The Analysed column shows the number of residues for which the sidechain conformation was analysed, and the total number of residues.

Mol	Chain	Analysed	Rotameric	Outliers	Percentiles	
1	A	359/378 (95%)	357 (99%)	2 (1%)	86	94
1	C	370/378 (98%)	365 (99%)	5 (1%)	67	81
2	B	360/383 (94%)	358 (99%)	2 (1%)	86	94
2	D	349/383 (91%)	344 (99%)	5 (1%)	67	81
3	E	104/127 (82%)	104 (100%)	0	100	100
4	F	243/342 (71%)	233 (96%)	10 (4%)	30	43
All	All	1785/1991 (90%)	1761 (99%)	24 (1%)	69	82

All (24) residues with a non-rotameric sidechain are listed below:

Mol	Chain	Res	Type
1	A	71	GLU

Continued on next page...

Continued from previous page...

Mol	Chain	Res	Type
1	A	370	LYS
2	B	137	HIS
2	B	205	GLU
1	C	1	MET
1	C	71	GLU
1	C	218	ASP
1	C	347[A]	CYS
1	C	347[B]	CYS
2	D	39	ASP
2	D	48	ASN
2	D	100	ASN
2	D	137	HIS
2	D	177	ASP
4	F	12	SER
4	F	34	ASN
4	F	45	ASN
4	F	174	ASP
4	F	197	ARG
4	F	222	ARG
4	F	230	SER
4	F	257	GLU
4	F	305	LYS
4	F	352	ASP

Sometimes sidechains can be flipped to improve hydrogen bonding and reduce clashes. All (13) such sidechains are listed below:

Mol	Chain	Res	Type
2	B	337	ASN
1	C	107	HIS
1	C	133	GLN
1	C	216	ASN
1	C	358	GLN
2	D	99	ASN
2	D	100	ASN
2	D	335	ASN
3	E	12	ASN
3	E	90	ASN
4	F	34	ASN
4	F	252	ASN
4	F	379	HIS

5.3.3 RNA [i](#)

There are no RNA molecules in this entry.

5.4 Non-standard residues in protein, DNA, RNA chains [i](#)

There are no non-standard protein/DNA/RNA residues in this entry.

5.5 Carbohydrates [i](#)

There are no monosaccharides in this entry.

5.6 Ligand geometry [i](#)

Of 17 ligands modelled in this entry, 6 are monoatomic - leaving 11 for Mogul analysis.

In the following table, the Counts columns list the number of bonds (or angles) for which Mogul statistics could be retrieved, the number of bonds (or angles) that are observed in the model and the number of bonds (or angles) that are defined in the Chemical Component Dictionary. The Link column lists molecule types, if any, to which the group is linked. The Z score for a bond length (or angle) is the number of standard deviations the observed value is removed from the expected value. A bond length (or angle) with $|Z| > 2$ is considered an outlier worth inspection. RMSZ is the root-mean-square of all Z scores of the bond lengths (or angles).

Mol	Type	Chain	Res	Link	Bond lengths			Bond angles		
					Counts	RMSZ	# Z > 2	Counts	RMSZ	# Z > 2
10	MES	B	502	-	12,12,12	2.27	1 (8%)	14,16,16	1.94	5 (35%)
12	ACP	F	402	7	27,33,33	4.69	10 (37%)	32,52,52	2.32	4 (12%)
11	G8K	B	506	-	29,31,31	0.69	1 (3%)	35,44,44	0.73	1 (2%)
11	G8K	D	502	-	29,31,31	0.70	1 (3%)	35,44,44	0.73	1 (2%)
8	GOL	A	504	-	5,5,5	0.90	0	5,5,5	1.00	0
5	GTP	A	501	7	26,34,34	1.13	2 (7%)	32,54,54	1.44	6 (18%)
8	GOL	B	505	-	5,5,5	0.92	0	5,5,5	0.98	0
5	GTP	D	501	-	26,34,34	1.13	2 (7%)	32,54,54	1.53	6 (18%)
5	GTP	C	501	7	26,34,34	1.12	2 (7%)	32,54,54	1.46	6 (18%)
10	MES	B	503	-	12,12,12	2.29	1 (8%)	14,16,16	1.96	6 (42%)
9	GDP	B	501	7	24,30,30	0.95	1 (4%)	30,47,47	1.09	3 (10%)

In the following table, the Chirals column lists the number of chiral outliers, the number of chiral centers analysed, the number of these observed in the model and the number defined in the Chemical Component Dictionary. Similar counts are reported in the Torsion and Rings columns.

'-' means no outliers of that kind were identified.

Mol	Type	Chain	Res	Link	Chirals	Torsions	Rings
10	MES	B	502	-	-	5/6/14/14	0/1/1/1
12	ACP	F	402	7	-	3/15/38/38	0/3/3/3
11	G8K	B	506	-	-	1/14/18/18	0/4/4/4
11	G8K	D	502	-	-	1/14/18/18	0/4/4/4
8	GOL	A	504	-	-	2/4/4/4	-
5	GTP	A	501	7	-	6/18/38/38	0/3/3/3
8	GOL	B	505	-	-	2/4/4/4	-
5	GTP	D	501	-	-	9/18/38/38	0/3/3/3
5	GTP	C	501	7	-	6/18/38/38	0/3/3/3
10	MES	B	503	-	-	0/6/14/14	0/1/1/1
9	GDP	B	501	7	-	3/12/32/32	0/3/3/3

All (21) bond length outliers are listed below:

Mol	Chain	Res	Type	Atoms	Z	Observed(Å)	Ideal(Å)
12	F	402	ACP	O4'-C1'	15.34	1.62	1.41
12	F	402	ACP	C2'-C1'	-14.66	1.31	1.53
10	B	503	MES	C8-S	-7.66	1.66	1.77
10	B	502	MES	C8-S	-7.61	1.66	1.77
12	F	402	ACP	PB-O3A	6.49	1.65	1.58
12	F	402	ACP	O4'-C4'	-6.34	1.30	1.45
5	D	501	GTP	C5-C6	-3.97	1.39	1.47
5	A	501	GTP	C5-C6	-3.96	1.39	1.47
5	C	501	GTP	C5-C6	-3.92	1.39	1.47
12	F	402	ACP	C6-N6	3.16	1.45	1.34
12	F	402	ACP	O2'-C2'	2.97	1.50	1.43
12	F	402	ACP	O3'-C3'	-2.89	1.36	1.43
12	F	402	ACP	C5-C4	-2.59	1.34	1.40
11	D	502	G8K	C10-N3	-2.53	1.32	1.35
11	B	506	G8K	C10-N3	-2.49	1.32	1.35
9	B	501	GDP	C6-N1	-2.31	1.34	1.37
5	D	501	GTP	C2-N3	2.23	1.38	1.33
12	F	402	ACP	C2-N3	2.16	1.35	1.32
5	A	501	GTP	C2-N3	2.14	1.38	1.33
5	C	501	GTP	C2-N3	2.11	1.38	1.33
12	F	402	ACP	PB-O2B	-2.08	1.51	1.56

All (38) bond angle outliers are listed below:

Mol	Chain	Res	Type	Atoms	Z	Observed(°)	Ideal(°)
12	F	402	ACP	C5-C6-N6	8.52	133.29	120.35
12	F	402	ACP	N6-C6-N1	-5.65	106.84	118.57
12	F	402	ACP	N3-C2-N1	-5.52	120.05	128.68
10	B	503	MES	C5-N4-C3	3.97	117.78	108.83
12	F	402	ACP	C3'-C2'-C1'	3.80	106.70	100.98
5	D	501	GTP	PA-O3A-PB	-3.44	121.03	132.83
10	B	502	MES	C5-N4-C3	3.39	116.46	108.83
5	D	501	GTP	PB-O3B-PG	-3.32	121.44	132.83
5	A	501	GTP	C5-C6-N1	3.19	119.58	113.95
5	D	501	GTP	C5-C6-N1	3.18	119.57	113.95
5	C	501	GTP	C5-C6-N1	3.17	119.55	113.95
5	C	501	GTP	PB-O3B-PG	-3.16	121.97	132.83
10	B	502	MES	C6-C5-N4	-3.10	105.39	110.10
5	A	501	GTP	PB-O3B-PG	-3.10	122.19	132.83
5	D	501	GTP	C8-N7-C5	3.03	108.75	102.99
5	C	501	GTP	C8-N7-C5	3.02	108.75	102.99
5	A	501	GTP	C8-N7-C5	2.99	108.68	102.99
10	B	502	MES	C7-N4-C5	2.98	118.84	111.23
10	B	503	MES	C6-C5-N4	-2.95	105.63	110.10
9	B	501	GDP	PA-O3A-PB	-2.87	122.97	132.83
5	D	501	GTP	C2-N1-C6	-2.84	119.86	125.10
5	A	501	GTP	C2-N1-C6	-2.82	119.90	125.10
5	C	501	GTP	C2-N1-C6	-2.81	119.93	125.10
5	C	501	GTP	PA-O3A-PB	-2.77	123.31	132.83
5	A	501	GTP	PA-O3A-PB	-2.61	123.88	132.83
10	B	502	MES	O3S-S-C8	2.60	109.98	105.77
10	B	503	MES	O3S-S-C8	2.54	109.88	105.77
11	D	502	G8K	C11-C10-N1	2.46	126.81	123.67
11	B	506	G8K	C11-C10-N1	2.43	126.77	123.67
9	B	501	GDP	C8-N7-C5	2.35	107.47	102.99
9	B	501	GDP	C5-C6-N1	2.29	117.99	113.95
5	A	501	GTP	O6-C6-C5	-2.17	120.13	124.37
5	D	501	GTP	O6-C6-C5	-2.13	120.20	124.37
5	C	501	GTP	O6-C6-C5	-2.09	120.29	124.37
10	B	503	MES	O2S-S-C8	2.08	109.42	106.92
10	B	503	MES	C7-N4-C3	2.08	116.55	111.23
10	B	503	MES	C7-N4-C5	2.07	116.53	111.23
10	B	502	MES	O1S-S-C8	2.00	109.33	106.92

There are no chirality outliers.

All (38) torsion outliers are listed below:

Mol	Chain	Res	Type	Atoms
5	A	501	GTP	PB-O3B-PG-O2G
5	A	501	GTP	C5'-O5'-PA-O1A
5	A	501	GTP	C5'-O5'-PA-O2A
5	C	501	GTP	PB-O3B-PG-O3G
5	C	501	GTP	C5'-O5'-PA-O1A
5	C	501	GTP	C5'-O5'-PA-O2A
5	D	501	GTP	C5'-O5'-PA-O2A
9	B	501	GDP	C5'-O5'-PA-O1A
9	B	501	GDP	C5'-O5'-PA-O2A
10	B	502	MES	C8-C7-N4-C5
10	B	502	MES	C7-C8-S-O1S
10	B	502	MES	C7-C8-S-O3S
12	F	402	ACP	C5'-O5'-PA-O3A
8	A	504	GOL	O1-C1-C2-C3
8	B	505	GOL	C1-C2-C3-O3
8	B	505	GOL	O2-C2-C3-O3
5	D	501	GTP	PB-O3B-PG-O1G
5	D	501	GTP	C5'-O5'-PA-O3A
5	D	501	GTP	C5'-O5'-PA-O1A
12	F	402	ACP	C5'-O5'-PA-O1A
12	F	402	ACP	C5'-O5'-PA-O2A
10	B	502	MES	C7-C8-S-O2S
8	A	504	GOL	O1-C1-C2-O2
10	B	502	MES	C8-C7-N4-C3
5	D	501	GTP	PB-O3A-PA-O1A
5	D	501	GTP	C3'-C4'-C5'-O5'
11	B	506	G8K	N1-C10-C11-C16
11	D	502	G8K	N1-C10-C11-C16
5	A	501	GTP	PB-O3B-PG-O3G
5	C	501	GTP	PB-O3B-PG-O2G
5	D	501	GTP	PB-O3B-PG-O2G
5	D	501	GTP	PB-O3B-PG-O3G
5	A	501	GTP	C5'-O5'-PA-O3A
5	C	501	GTP	C5'-O5'-PA-O3A
9	B	501	GDP	C5'-O5'-PA-O3A
5	D	501	GTP	PB-O3A-PA-O2A
5	A	501	GTP	C4'-C5'-O5'-PA
5	C	501	GTP	C4'-C5'-O5'-PA

There are no ring outliers.

7 monomers are involved in 7 short contacts:

Mol	Chain	Res	Type	Clashes	Symm-Clashes
11	B	506	G8K	1	0
11	D	502	G8K	1	0
8	A	504	GOL	1	0
5	A	501	GTP	1	0
5	D	501	GTP	1	0
10	B	503	MES	1	0
9	B	501	GDP	1	0

The following is a two-dimensional graphical depiction of Mogul quality analysis of bond lengths, bond angles, torsion angles, and ring geometry for all instances of the Ligand of Interest. In addition, ligands with molecular weight > 250 and outliers as shown on the validation Tables will also be included. For torsion angles, if less than 5% of the Mogul distribution of torsion angles is within 10 degrees of the torsion angle in question, then that torsion angle is considered an outlier. Any bond that is central to one or more torsion angles identified as an outlier by Mogul will be highlighted in the graph. For rings, the root-mean-square deviation (RMSD) between the ring in question and similar rings identified by Mogul is calculated over all ring torsion angles. If the average RMSD is greater than 60 degrees and the minimal RMSD between the ring in question and any Mogul-identified rings is also greater than 60 degrees, then that ring is considered an outlier. The outliers are highlighted in purple. The color gray indicates Mogul did not find sufficient equivalents in the CSD to analyse the geometry.

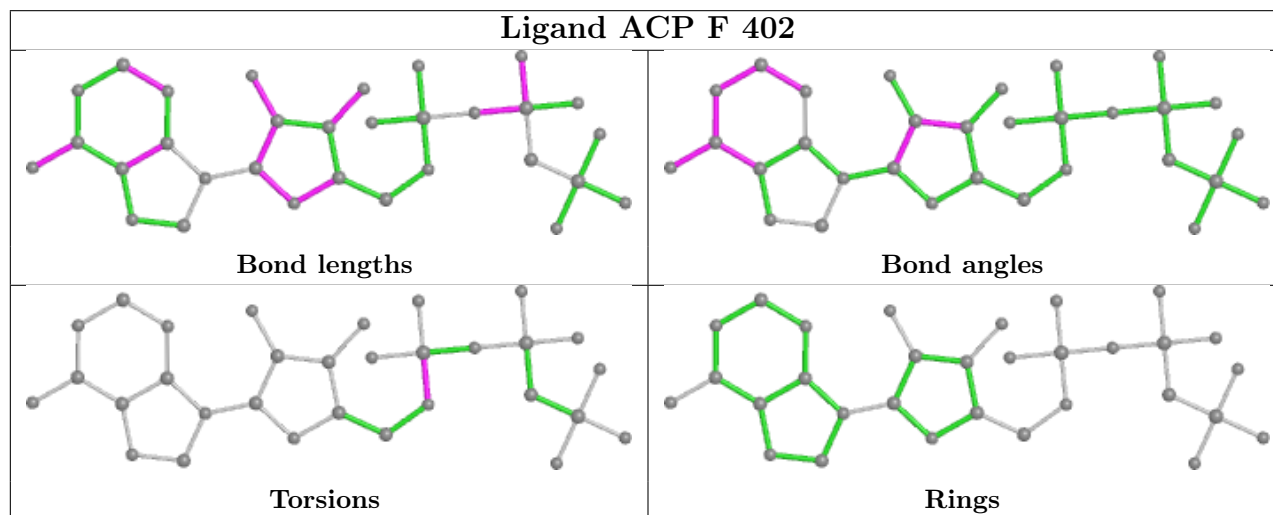

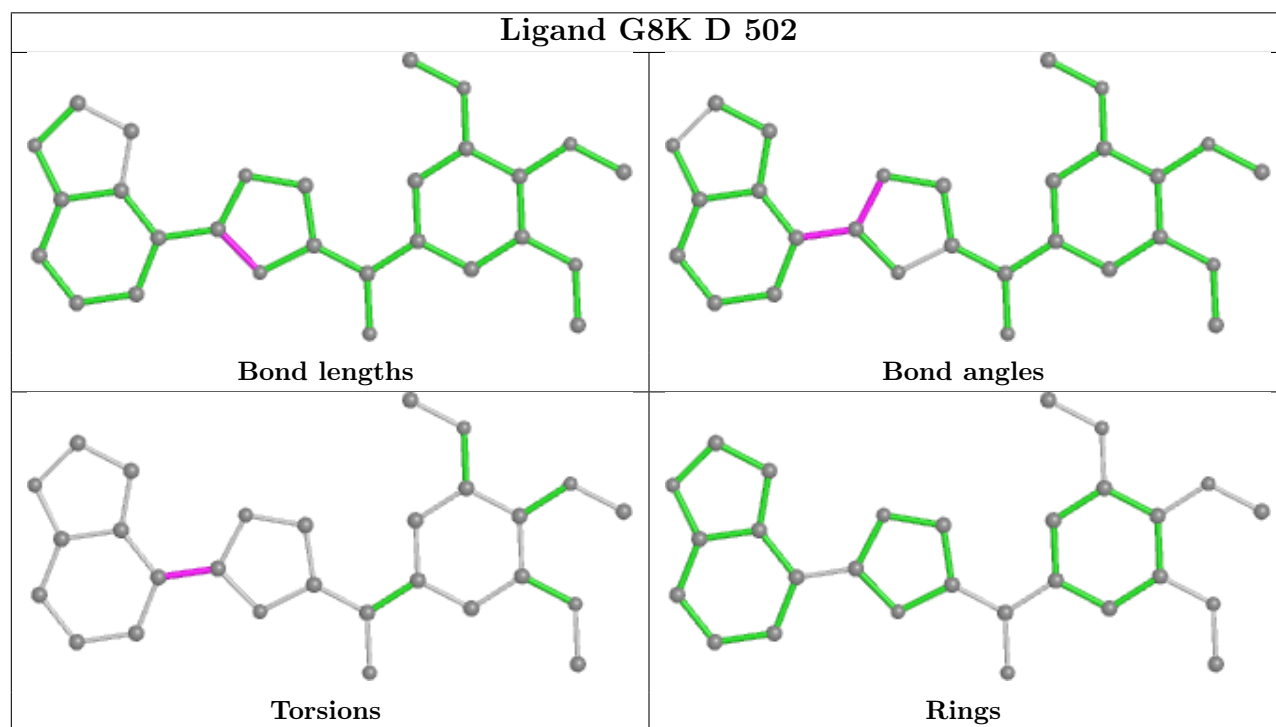
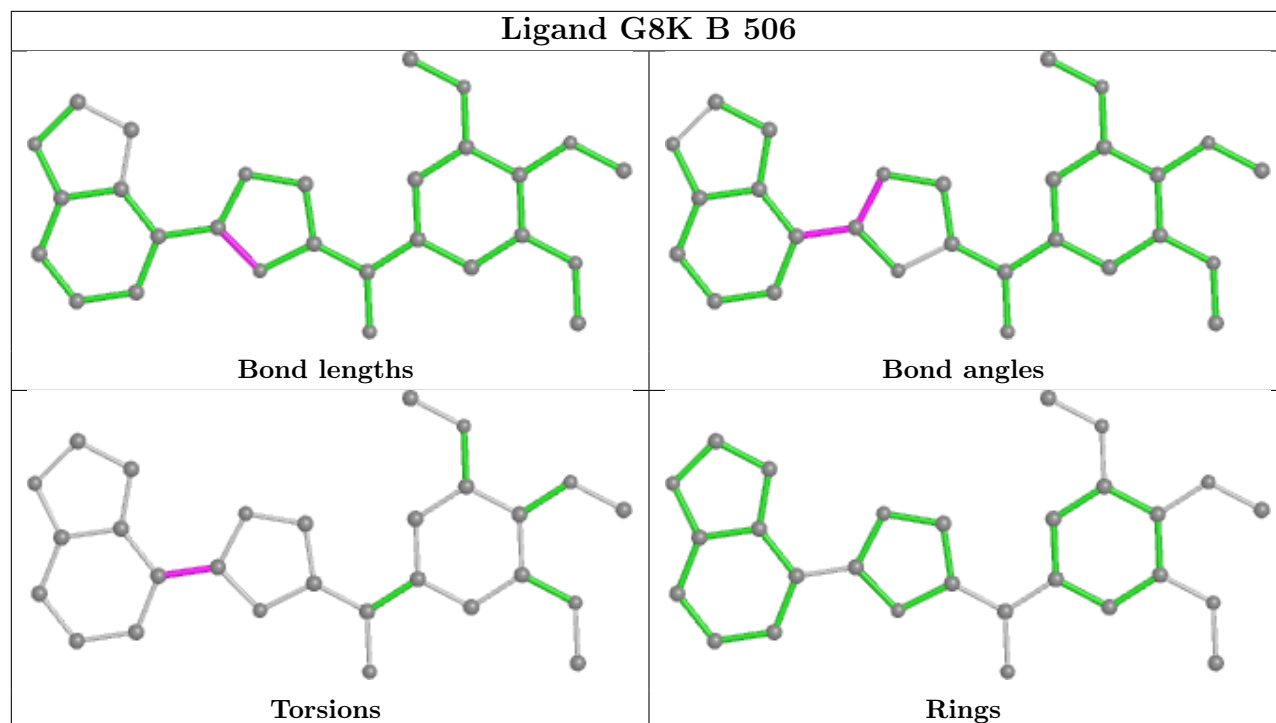

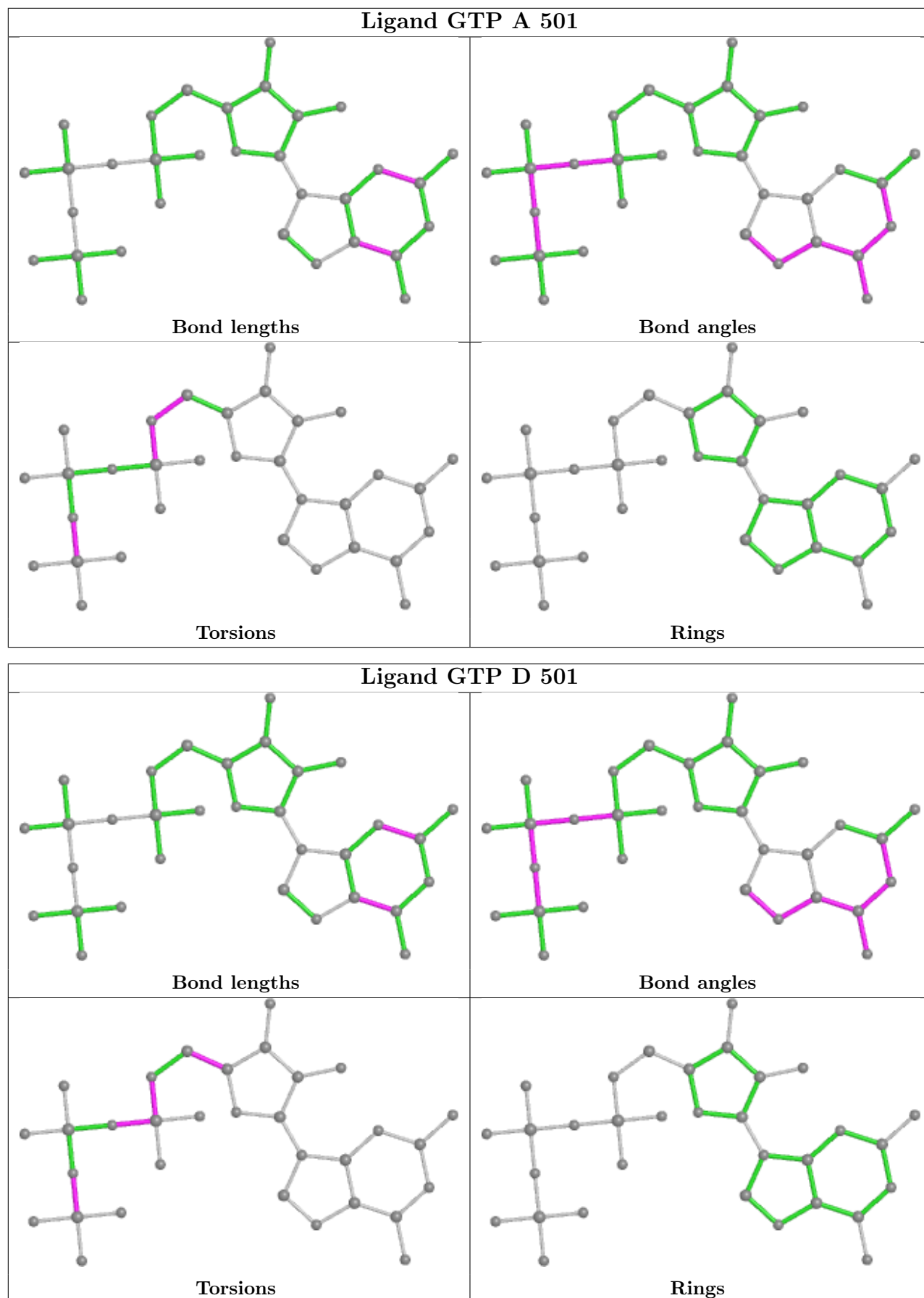

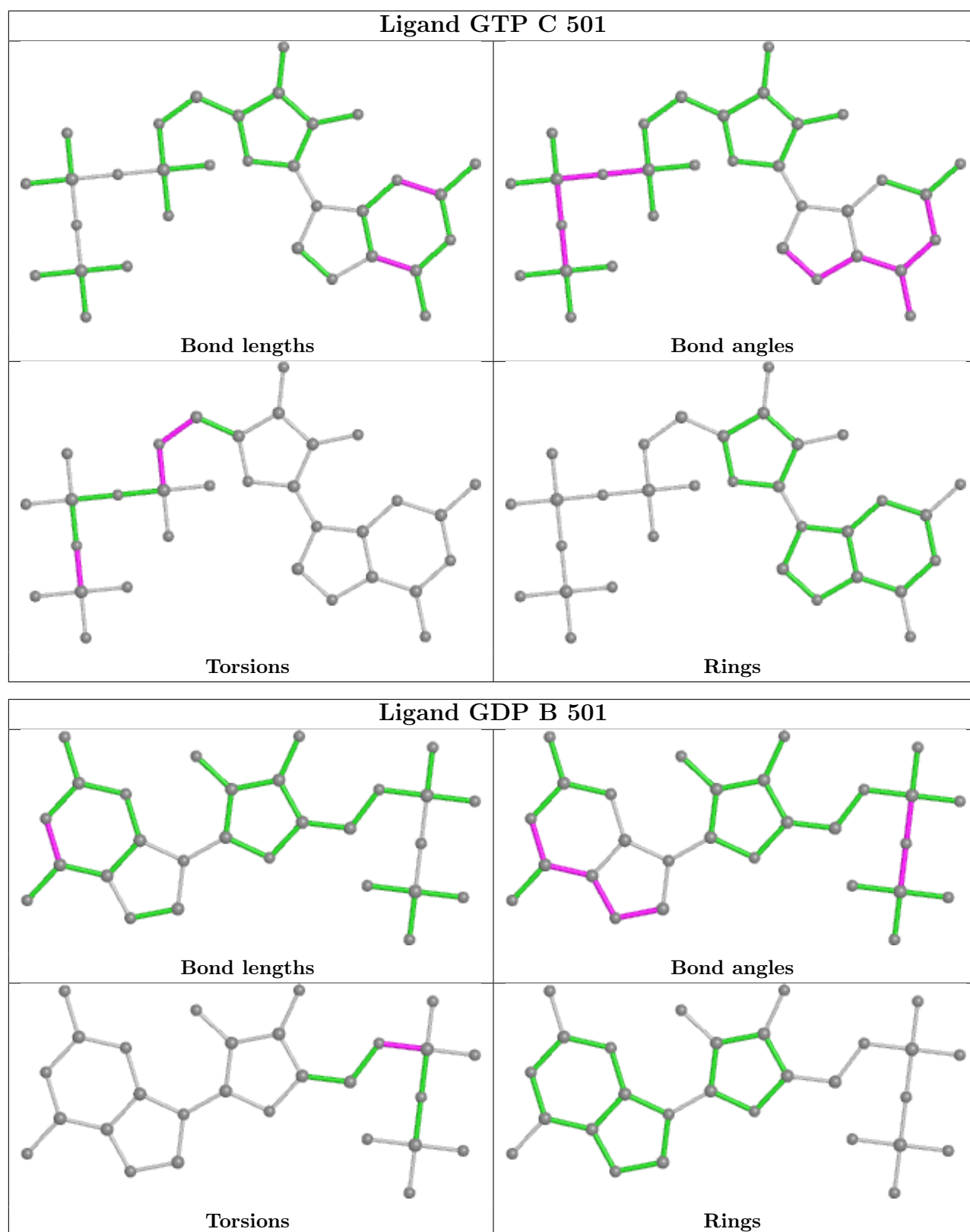

5.7 Other polymers [i](#)

There are no such residues in this entry.

5.8 Polymer linkage issues

There are no chain breaks in this entry.

6 Fit of model and data

6.1 Protein, DNA and RNA chains

In the following table, the column labelled ‘#RSRZ > 2’ contains the number (and percentage) of RSRZ outliers, followed by percent RSRZ outliers for the chain as percentile scores relative to all X-ray entries and entries of similar resolution. The OWAB column contains the minimum, median, 95th percentile and maximum values of the occupancy-weighted average B-factor per residue. The column labelled ‘Q < 0.9’ lists the number of (and percentage) of residues with an average occupancy less than 0.9.

Mol	Chain	Analysed	<RSRZ>	#RSRZ>2	OWAB(Å ²)	Q<0.9
1	A	437/450 (97%)	-0.04	3 (0%) 87 91	19, 36, 60, 77	0
1	C	440/450 (97%)	-0.15	2 (0%) 91 94	16, 27, 52, 82	0
2	B	427/445 (95%)	0.01	14 (3%) 46 53	17, 35, 69, 119	0
2	D	421/445 (94%)	0.37	34 (8%) 12 16	25, 48, 81, 114	0
3	E	120/143 (83%)	0.23	10 (8%) 11 15	24, 50, 78, 100	0
4	F	327/384 (85%)	1.23	98 (29%) 0 0	26, 63, 111, 154	0
All	All	2172/2317 (93%)	0.23	161 (7%) 14 19	16, 40, 83, 154	0

All (161) RSRZ outliers are listed below:

Mol	Chain	Res	Type	RSRZ
4	F	133	ALA	7.8
4	F	134	ALA	7.5
2	B	55	THR	7.1
4	F	166	ALA	6.9
2	B	57	ASN	6.8
4	F	173	ILE	6.4
4	F	165	GLU	6.1
4	F	170	LEU	5.9
4	F	132	LEU	5.8
4	F	231	ALA	5.8
4	F	131	PHE	5.8
2	D	55	THR	5.4
4	F	233	PHE	5.4
4	F	172	PHE	5.1
4	F	259	GLY	5.0
4	F	256	TYR	5.0
4	F	178	GLN	5.0
4	F	138	ARG	4.9
4	F	101	TYR	4.8

Continued on next page...

Continued from previous page...

Mol	Chain	Res	Type	RSRZ
2	D	54	ALA	4.6
2	D	37	HIS	4.6
4	F	22	LEU	4.6
4	F	232	ASN	4.5
4	F	361	LEU	4.5
4	F	239	HIS	4.4
4	F	21	LEU	4.4
4	F	100	ILE	4.4
4	F	253	TYR	4.3
2	B	54	ALA	4.2
1	C	1	MET	4.2
4	F	130	VAL	4.2
2	D	394	PHE	4.1
2	B	56	GLY	4.0
4	F	102	PRO	4.0
4	F	23	ALA	4.0
4	F	236	LYS	4.0
2	D	95	SER	4.0
4	F	25	GLY	3.9
2	B	427	ASP	3.9
4	F	234	GLN	3.9
2	B	58	LYS	3.9
2	B	37	HIS	3.7
4	F	1	MET	3.7
4	F	140	GLU	3.6
4	F	99	VAL	3.6
4	F	11	SER	3.6
2	B	36	TYR	3.6
4	F	141	GLY	3.6
4	F	194	PRO	3.6
4	F	244	CYS	3.5
4	F	177	GLY	3.5
4	F	254	GLY	3.5
4	F	179	VAL	3.5
2	D	219	THR	3.4
4	F	149	ALA	3.4
4	F	174	ASP	3.4
2	D	406	MET	3.4
3	E	46	SER	3.4
2	B	38	GLY	3.4
4	F	98	TYR	3.4
2	B	39	ASP	3.4

Continued on next page...

Continued from previous page...

Mol	Chain	Res	Type	RSRZ
4	F	243	HIS	3.4
4	F	180	HIS	3.3
4	F	225	SER	3.3
2	D	80	PRO	3.2
2	D	397	TRP	3.2
2	D	75	SER	3.2
4	F	192	LEU	3.2
4	F	237	THR	3.1
4	F	9	GLU	3.1
4	F	13	VAL	3.1
4	F	227	PRO	3.0
2	D	33	THR	3.0
4	F	171	ASP	3.0
4	F	20	LEU	3.0
2	D	57	ASN	3.0
2	D	74	ASP	3.0
4	F	228	TYR	3.0
4	F	191	LEU	3.0
2	D	391	ARG	3.0
4	F	255	ARG	3.0
4	F	235	ASP	3.0
4	F	136	ASN	3.0
2	B	72	THR	3.0
4	F	176	GLN	2.9
4	F	245	ILE	2.9
4	F	379	HIS	2.9
2	D	405	GLU	2.9
4	F	27	TRP	2.9
4	F	161	LEU	2.9
4	F	260	ASN	2.8
1	A	282	TYR	2.8
4	F	17	VAL	2.8
2	D	395	LEU	2.7
2	B	95	SER	2.7
3	E	48	GLU	2.7
4	F	196	HIS	2.7
4	F	261	GLU	2.7
4	F	337	ALA	2.7
2	D	48	ASN	2.7
4	F	238	CYS	2.7
4	F	199	PHE	2.7
4	F	341	LYS	2.6

Continued on next page...

Continued from previous page...

Mol	Chain	Res	Type	RSRZ
3	E	133	VAL	2.6
4	F	230	SER	2.6
2	D	396	HIS	2.6
2	D	83	GLN	2.6
4	F	224	SER	2.6
1	C	377	MET	2.6
1	A	42	ILE	2.5
4	F	223	THR	2.5
4	F	347	CYS	2.5
2	D	72	THR	2.5
4	F	145	ASN	2.5
2	D	39	ASP	2.4
3	E	59	GLU	2.4
4	F	164	SER	2.4
2	D	175	VAL	2.4
4	F	14	TYR	2.4
2	D	180	VAL	2.4
4	F	10	ASN	2.4
4	F	252	ASN	2.4
4	F	197	ARG	2.4
4	F	338	CYS	2.4
2	D	431	ASP	2.4
4	F	135	TYR	2.3
2	D	389	PHE	2.3
1	A	57	GLY	2.3
4	F	186	LEU	2.3
4	F	24	THR	2.3
4	F	220	VAL	2.3
3	E	45	PRO	2.3
4	F	129	GLU	2.2
4	F	258	GLU	2.2
2	D	78	SER	2.2
4	F	163	SER	2.2
2	D	71	GLY	2.2
4	F	263	PHE	2.2
4	F	339	ALA	2.2
4	F	343	TYR	2.2
2	D	179	VAL	2.2
2	D	81	PHE	2.2
2	B	277	GLY	2.2
2	D	244	GLY	2.2
4	F	162	ILE	2.2

Continued on next page...

Continued from previous page...

Mol	Chain	Res	Type	RSRZ
3	E	27	PRO	2.2
2	D	387	ALA	2.2
3	E	139	LEU	2.1
3	E	26	PRO	2.1
4	F	167	SER	2.1
4	F	147	TRP	2.1
3	E	6	MET	2.1
2	D	177	ASP	2.1
4	F	26	GLN	2.1
2	B	282	ARG	2.1
4	F	142	ARG	2.1
4	F	6	VAL	2.1
3	E	28	SER	2.0
2	D	86	ARG	2.0
2	D	392	LYS	2.0
4	F	320	MET	2.0

6.2 Non-standard residues in protein, DNA, RNA chains [i](#)

There are no non-standard protein/DNA/RNA residues in this entry.

6.3 Carbohydrates [i](#)

There are no monosaccharides in this entry.

6.4 Ligands [i](#)

In the following table, the Atoms column lists the number of modelled atoms in the group and the number defined in the chemical component dictionary. The B-factors column lists the minimum, median, 95th percentile and maximum values of B factors of atoms in the group. The column labelled 'Q< 0.9' lists the number of atoms with occupancy less than 0.9.

Mol	Type	Chain	Res	Atoms	RSCC	RSR	B-factors(Å ²)	Q<0.9
8	GOL	B	505	6/6	0.82	0.19	36,46,52,53	0
12	ACP	F	402	31/31	0.87	0.18	64,78,105,109	0
11	G8K	D	502	28/28	0.89	0.20	36,46,56,67	0
7	MG	B	504	1/1	0.92	0.38	41,41,41,41	0
7	MG	F	401	1/1	0.93	0.08	81,81,81,81	0
10	MES	B	503	12/12	0.93	0.14	49,53,71,76	12
10	MES	B	502	12/12	0.94	0.15	34,54,66,73	0

Continued on next page...

Continued from previous page...

Mol	Type	Chain	Res	Atoms	RSCC	RSR	B-factors(\AA^2)	Q<0.9
8	GOL	A	504	6/6	0.94	0.11	36,46,49,50	0
11	G8K	B	506	28/28	0.95	0.12	22,32,36,43	0
5	GTP	D	501	32/32	0.96	0.11	36,47,55,61	0
9	GDP	B	501	28/28	0.97	0.16	18,22,31,32	0
6	CA	A	502	1/1	0.97	0.04	54,54,54,54	0
6	CA	C	502	1/1	0.98	0.04	36,36,36,36	0
7	MG	A	503	1/1	0.98	0.11	27,27,27,27	0
5	GTP	A	501	32/32	0.98	0.16	20,23,34,38	0
5	GTP	C	501	32/32	0.98	0.13	19,21,28,32	0
7	MG	C	503	1/1	0.99	0.11	23,23,23,23	0

The following is a graphical depiction of the model fit to experimental electron density of all instances of the Ligand of Interest. In addition, ligands with molecular weight > 250 and outliers as shown on the geometry validation Tables will also be included. Each fit is shown from different orientation to approximate a three-dimensional view.

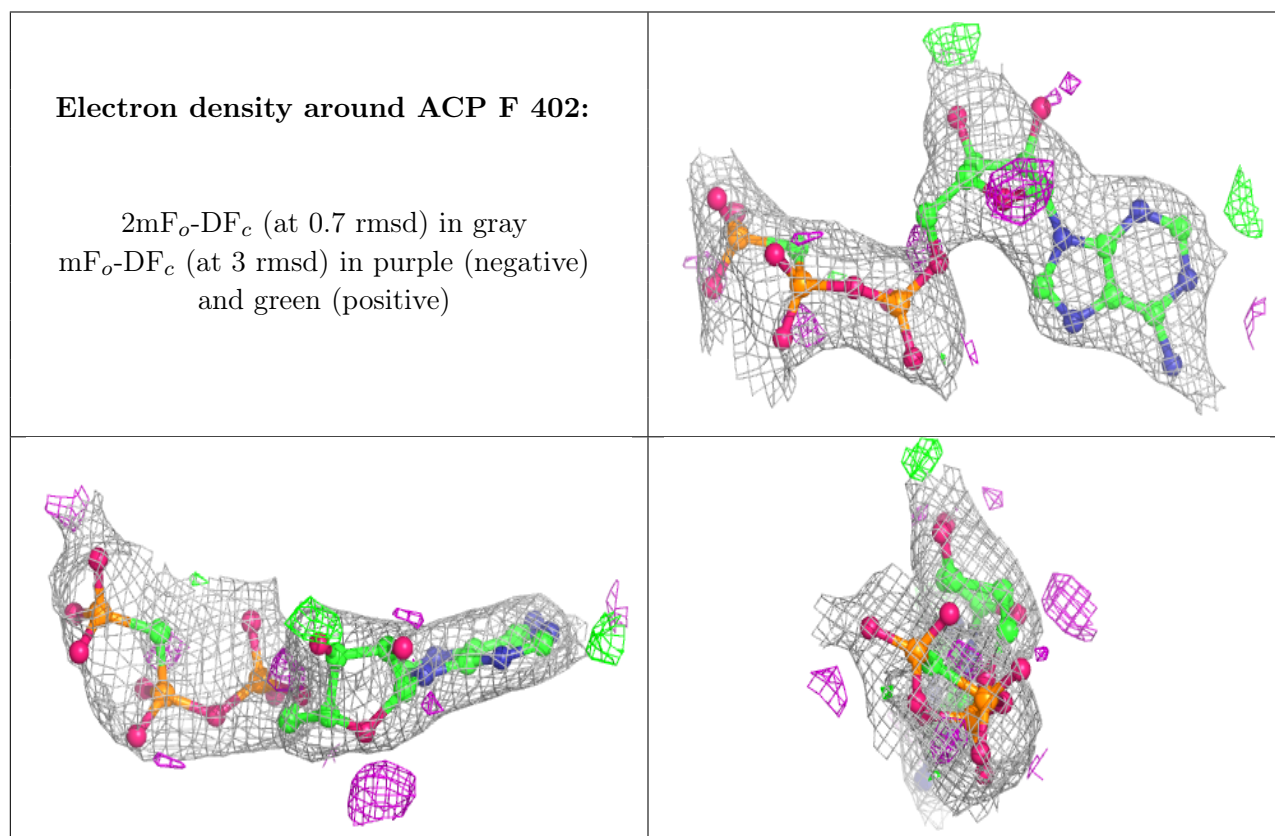

Electron density around G8K D 502:

$2mF_o-DF_c$ (at 0.7 rmsd) in gray
 mF_o-DF_c (at 3 rmsd) in purple (negative)
and green (positive)

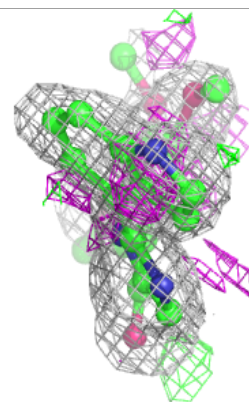
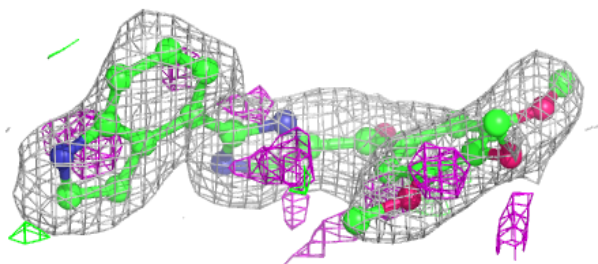
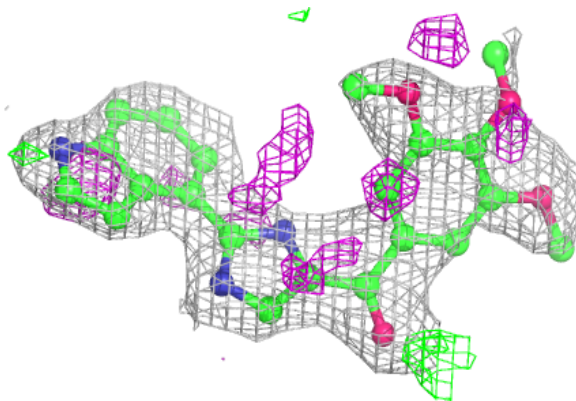
**Electron density around G8K B 506:**

$2mF_o-DF_c$ (at 0.7 rmsd) in gray
 mF_o-DF_c (at 3 rmsd) in purple (negative)
and green (positive)

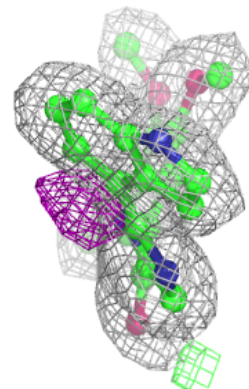
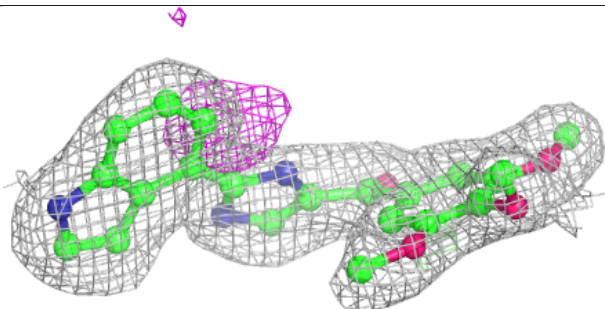
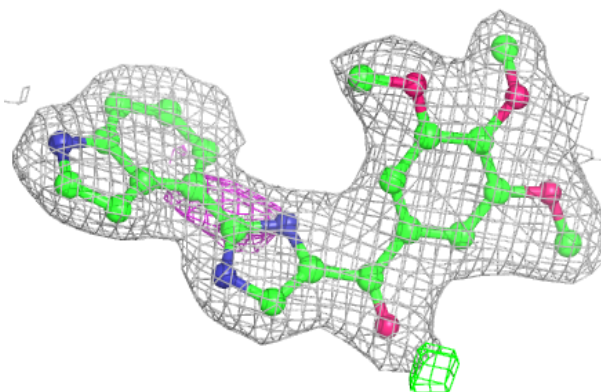

Electron density around GTP D 501:

$2mF_o-DF_c$ (at 0.7 rmsd) in gray
 mF_o-DF_c (at 3 rmsd) in purple (negative)
and green (positive)

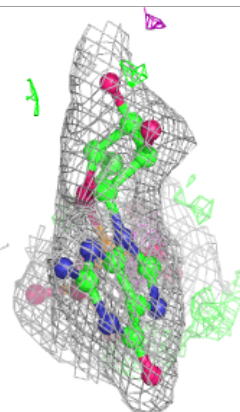
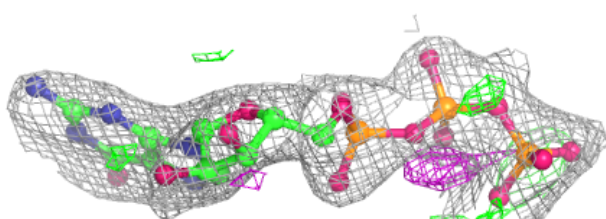
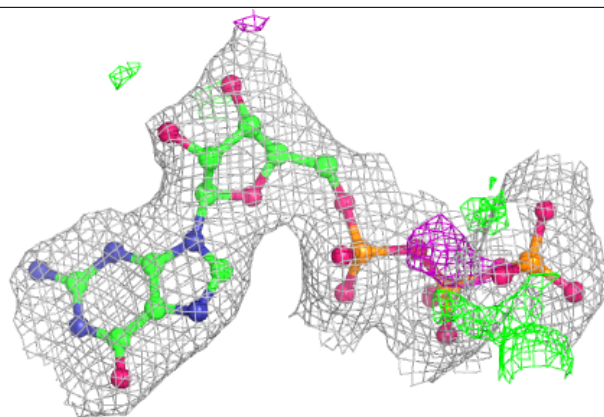
**Electron density around GDP B 501:**

$2mF_o-DF_c$ (at 0.7 rmsd) in gray
 mF_o-DF_c (at 3 rmsd) in purple (negative)
and green (positive)

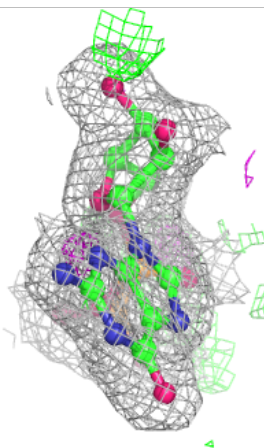
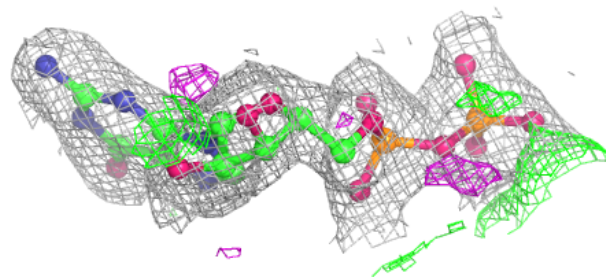
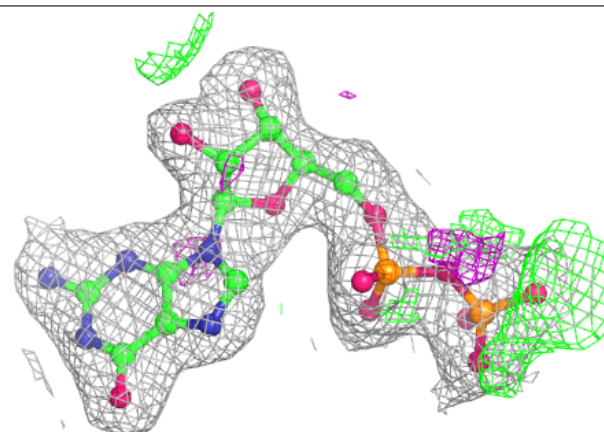

Electron density around GTP A 501:

$2mF_o-DF_c$ (at 0.7 rmsd) in gray
 mF_o-DF_c (at 3 rmsd) in purple (negative)
and green (positive)

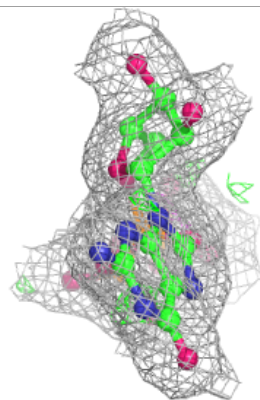
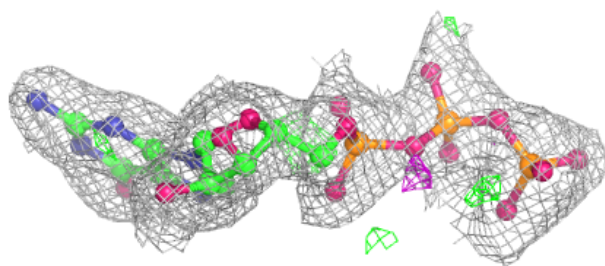
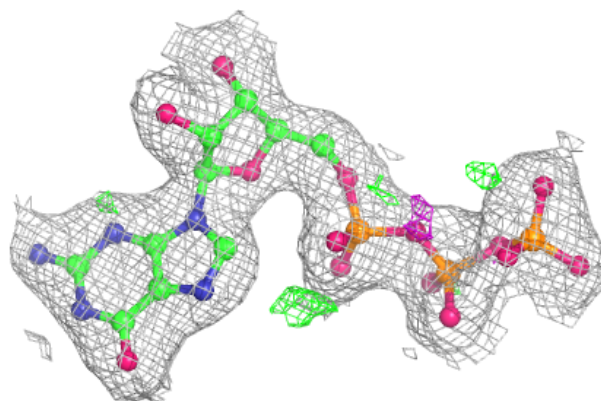
**Electron density around GTP C 501:**

$2mF_o-DF_c$ (at 0.7 rmsd) in gray
 mF_o-DF_c (at 3 rmsd) in purple (negative)
and green (positive)

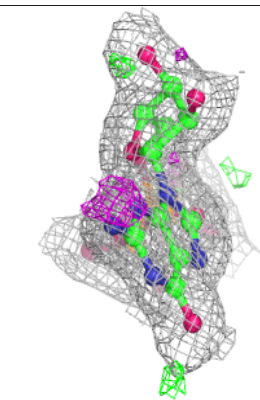
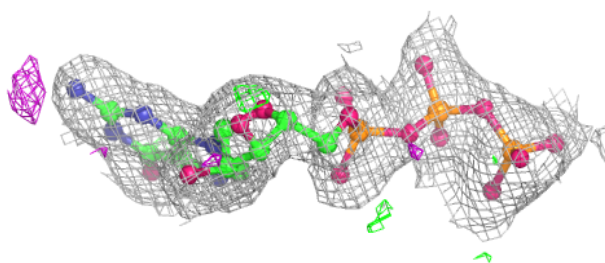
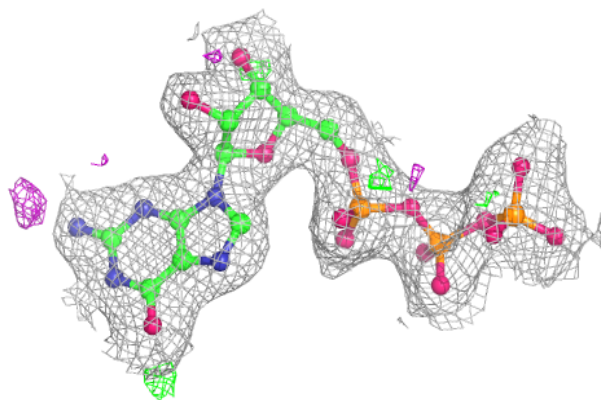

6.5 Other polymers

There are no such residues in this entry.