



wwPDB X-ray Structure Validation Summary Report ⓘ

May 15, 2020 – 02:02 pm BST

PDB ID : 6DFW
Title : TCR 8F10 in complex with IAg7-p8G9E
Authors : Wang, Y.; Dai, S.
Deposited on : 2018-05-15
Resolution : 3.20 Å(reported)

This is a wwPDB X-ray Structure Validation Summary Report for a publicly released PDB entry.

We welcome your comments at validation@mail.wwpdb.org

A user guide is available at

<https://www.wwpdb.org/validation/2017/XrayValidationReportHelp>

with specific help available everywhere you see the ⓘ symbol.

The following versions of software and data (see [references ⓘ](#)) were used in the production of this report:

MolProbity : 4.02b-467
Xtriage (Phenix) : 1.13
EDS : 2.11
Percentile statistics : 20191225.v01 (using entries in the PDB archive December 25th 2019)
Refmac : 5.8.0158
CCP4 : 7.0.044 (Gargrove)
Ideal geometry (proteins) : Engh & Huber (2001)
Ideal geometry (DNA, RNA) : Parkinson et al. (1996)
Validation Pipeline (wwPDB-VP) : 2.11

1 Overall quality at a glance

The following experimental techniques were used to determine the structure:

X-RAY DIFFRACTION

The reported resolution of this entry is 3.20 Å.

Percentile scores (ranging between 0-100) for global validation metrics of the entry are shown in the following graphic. The table shows the number of entries on which the scores are based.

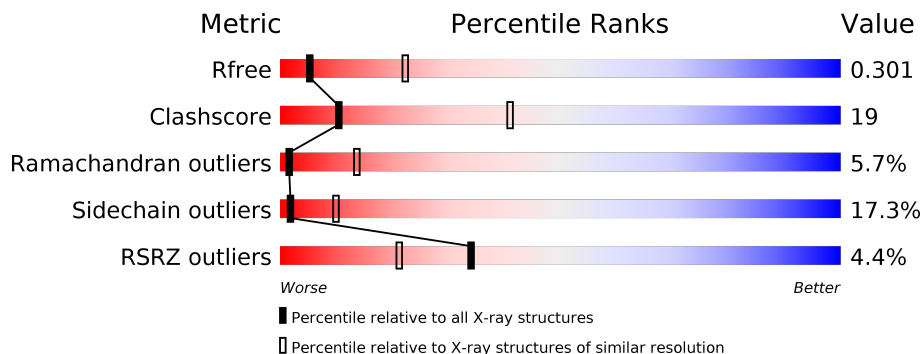



Metric	Whole archive (#Entries)	Similar resolution (#Entries, resolution range(Å))
R_{free}	130704	1133 (3.20-3.20)
Clashscore	141614	1253 (3.20-3.20)
Ramachandran outliers	138981	1234 (3.20-3.20)
Sidechain outliers	138945	1233 (3.20-3.20)
RSRZ outliers	127900	1095 (3.20-3.20)

The table below summarises the geometric issues observed across the polymeric chains and their fit to the electron density. The red, orange, yellow and green segments on the lower bar indicate the fraction of residues that contain outliers for ≥ 3 , 2, 1 and 0 types of geometric quality criteria respectively. A grey segment represents the fraction of residues that are not modelled. The numeric value for each fraction is indicated below the corresponding segment, with a dot representing fractions $\leq 5\%$. The upper red bar (where present) indicates the fraction of residues that have poor fit to the electron density. The numeric value is given above the bar.

Mol	Chain	Length	Quality of chain
1	A	183	
1	C	183	
2	B	221	
2	D	221	
3	E	210	
3	G	210	

Continued on next page...

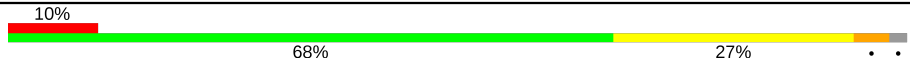
Continued from previous page...

Mol	Chain	Length	Quality of chain
4	F	241	
4	H	241	

2 Entry composition [i](#)

There are 4 unique types of molecules in this entry. The entry contains 12219 atoms, of which 0 are hydrogens and 0 are deuteriums.

In the tables below, the ZeroOcc column contains the number of atoms modelled with zero occupancy, the AltConf column contains the number of residues with at least one atom in alternate conformation and the Trace column contains the number of residues modelled with at most 2 atoms.

- Molecule 1 is a protein called H-2 class II histocompatibility antigen, A-D alpha chain.

Mol	Chain	Residues	Atoms					ZeroOcc	AltConf	Trace
			Total	C	N	O	S			
1	A	182	1489	962	241	284	2	0	2	0
1	C	182	1477	954	239	282	2	0	1	0

- Molecule 2 is a protein called H2-Ab1 protein.

Mol	Chain	Residues	Atoms					ZeroOcc	AltConf	Trace
			Total	C	N	O	S			
2	B	192	1595	1003	288	297	7	0	0	0
2	D	192	1584	997	283	297	7	0	0	0

There are 66 discrepancies between the modelled and reference sequences:

Chain	Residue	Modelled	Actual	Comment	Reference
B	-28	HIS	-	expression tag	UNP Q31135
B	-27	LEU	-	expression tag	UNP Q31135
B	-26	VAL	-	expression tag	UNP Q31135
B	-25	GLU	-	expression tag	UNP Q31135
B	-24	ARG	-	expression tag	UNP Q31135
B	-23	LEU	-	expression tag	UNP Q31135
B	-22	TYR	-	expression tag	UNP Q31135
B	-21	LEU	-	expression tag	UNP Q31135
B	-20	VAL	-	expression tag	UNP Q31135
B	-19	CYS	-	expression tag	UNP Q31135
B	-18	GLY	-	expression tag	UNP Q31135
B	-17	GLY	-	expression tag	UNP Q31135
B	-16	GLU	-	expression tag	UNP Q31135
B	-15	GLY	-	expression tag	UNP Q31135
B	-9	ALA	-	expression tag	UNP Q31135
B	-8	GLY	-	expression tag	UNP Q31135

Continued on next page...

Continued from previous page...

Chain	Residue	Modelled	Actual	Comment	Reference
B	-7	GLY	-	expression tag	UNP Q31135
B	-6	GLY	-	expression tag	UNP Q31135
B	-5	SER	-	expression tag	UNP Q31135
B	-4	LEU	-	expression tag	UNP Q31135
B	-3	VAL	-	expression tag	UNP Q31135
B	-2	GLY	-	expression tag	UNP Q31135
B	-1	GLY	-	expression tag	UNP Q31135
B	0	SER	-	expression tag	UNP Q31135
B	1	GLY	-	expression tag	UNP Q31135
B	2	GLY	-	expression tag	UNP Q31135
B	3	GLY	-	expression tag	UNP Q31135
B	192	GLY	-	expression tag	UNP Q31135
B	193	GLY	-	expression tag	UNP Q31135
B	194	LEU	-	expression tag	UNP Q31135
B	195	VAL	-	expression tag	UNP Q31135
B	196	PRO	-	expression tag	UNP Q31135
B	197	ARG	-	expression tag	UNP Q31135
D	-28	HIS	-	expression tag	UNP Q31135
D	-27	LEU	-	expression tag	UNP Q31135
D	-26	VAL	-	expression tag	UNP Q31135
D	-25	GLU	-	expression tag	UNP Q31135
D	-24	ARG	-	expression tag	UNP Q31135
D	-23	LEU	-	expression tag	UNP Q31135
D	-22	TYR	-	expression tag	UNP Q31135
D	-21	LEU	-	expression tag	UNP Q31135
D	-20	VAL	-	expression tag	UNP Q31135
D	-19	CYS	-	expression tag	UNP Q31135
D	-18	GLY	-	expression tag	UNP Q31135
D	-17	GLY	-	expression tag	UNP Q31135
D	-16	GLU	-	expression tag	UNP Q31135
D	-15	GLY	-	expression tag	UNP Q31135
D	-9	ALA	-	expression tag	UNP Q31135
D	-8	GLY	-	expression tag	UNP Q31135
D	-7	GLY	-	expression tag	UNP Q31135
D	-6	GLY	-	expression tag	UNP Q31135
D	-5	SER	-	expression tag	UNP Q31135
D	-4	LEU	-	expression tag	UNP Q31135
D	-3	VAL	-	expression tag	UNP Q31135
D	-2	GLY	-	expression tag	UNP Q31135
D	-1	GLY	-	expression tag	UNP Q31135
D	0	SER	-	expression tag	UNP Q31135
D	1	GLY	-	expression tag	UNP Q31135

Continued on next page...

Continued from previous page...

Chain	Residue	Modelled	Actual	Comment	Reference
D	2	GLY	-	expression tag	UNP Q31135
D	3	GLY	-	expression tag	UNP Q31135
D	192	GLY	-	expression tag	UNP Q31135
D	193	GLY	-	expression tag	UNP Q31135
D	194	LEU	-	expression tag	UNP Q31135
D	195	VAL	-	expression tag	UNP Q31135
D	196	PRO	-	expression tag	UNP Q31135
D	197	ARG	-	expression tag	UNP Q31135

- Molecule 3 is a protein called 8F10 alpha chain.

Mol	Chain	Residues	Atoms					ZeroOcc	AltConf	Trace
			Total	C	N	O	S			
3	E	139	1075	671	183	216	5	0	0	0
3	G	177	1381	868	230	276	7	0	1	0

- Molecule 4 is a protein called 8F10 beta chain.

Mol	Chain	Residues	Atoms					ZeroOcc	AltConf	Trace
			Total	C	N	O	S			
4	F	237	1811	1148	316	341	6	0	0	0
4	H	235	1807	1145	318	338	6	0	0	0

3 Residue-property plots [i](#)

These plots are drawn for all protein, RNA and DNA chains in the entry. The first graphic for a chain summarises the proportions of the various outlier classes displayed in the second graphic. The second graphic shows the sequence view annotated by issues in geometry and electron density. Residues are color-coded according to the number of geometric quality criteria for which they contain at least one outlier: green = 0, yellow = 1, orange = 2 and red = 3 or more. A red dot above a residue indicates a poor fit to the electron density ($RSRZ > 2$). Stretches of 2 or more consecutive residues without any outlier are shown as a green connector. Residues present in the sample, but not in the model, are shown in grey.

- Molecule 1: H-2 class II histocompatibility antigen, A-D alpha chain

Chain A: 

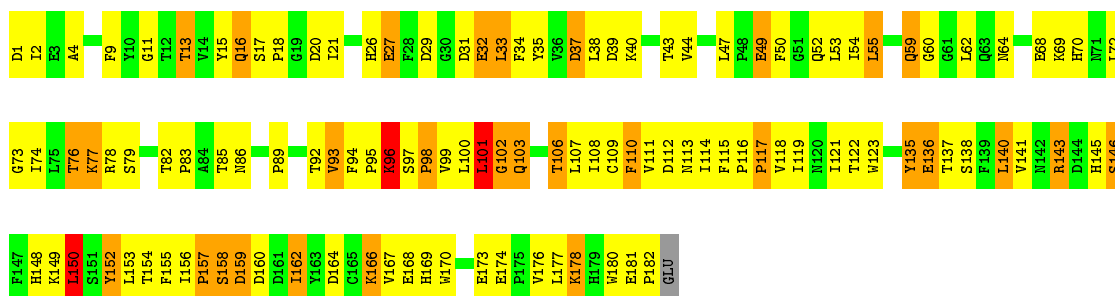

- Molecule 1: H-2 class II histocompatibility antigen, A-D alpha chain

Chain C: 

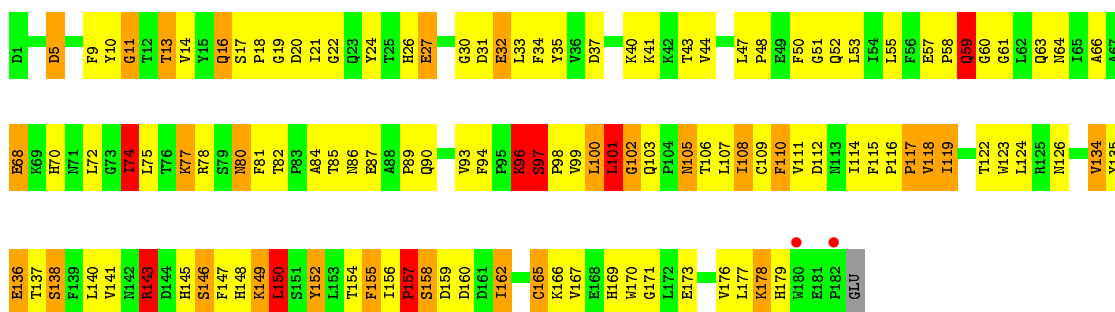

- Molecule 2: H2-Ab1 protein

Chain B: 

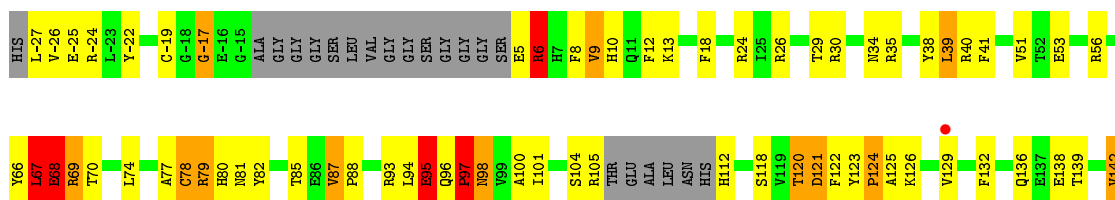

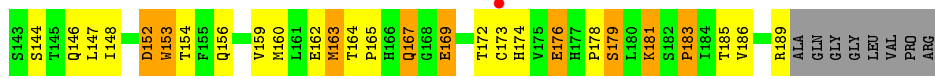

• Molecule 2: H2-Ab1 protein

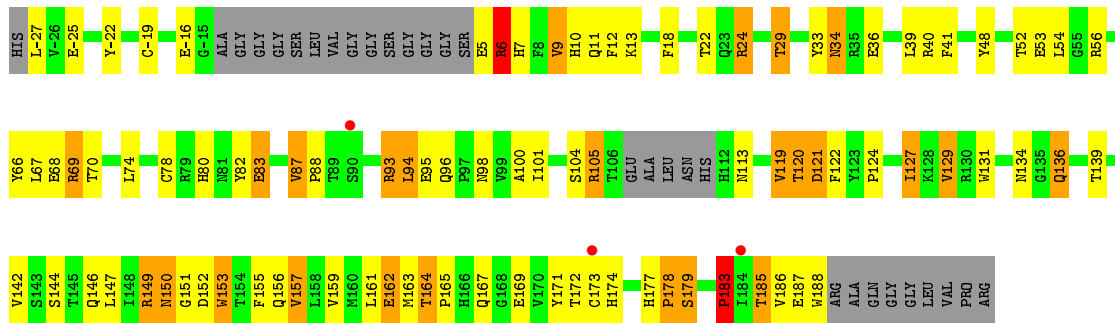
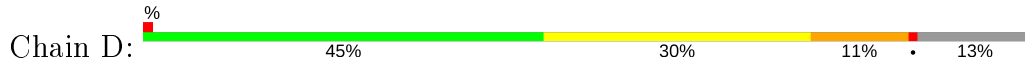

• Molecule 3: 8F10 alpha chain

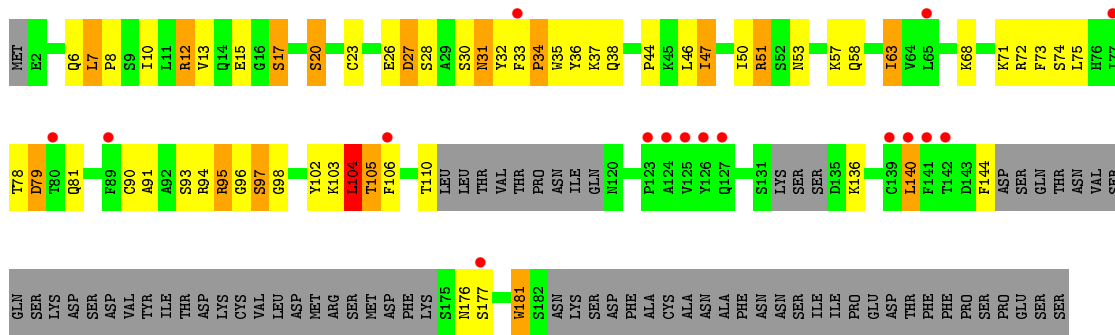

• Molecule 3: 8F10 alpha chain

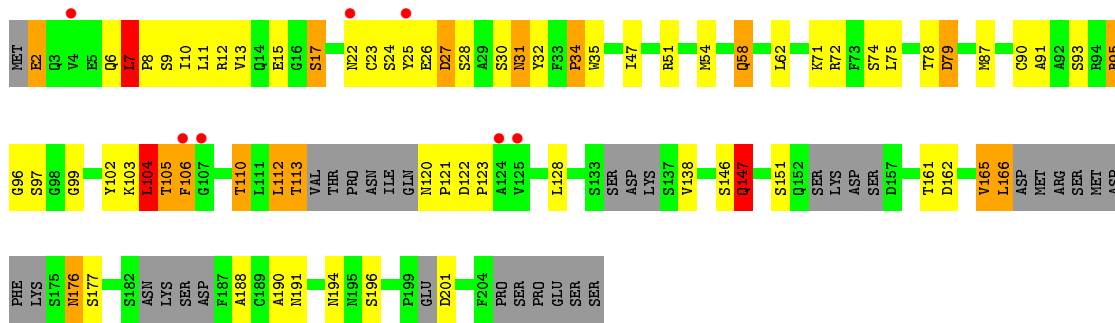

• Molecule 4: 8F10 beta chain



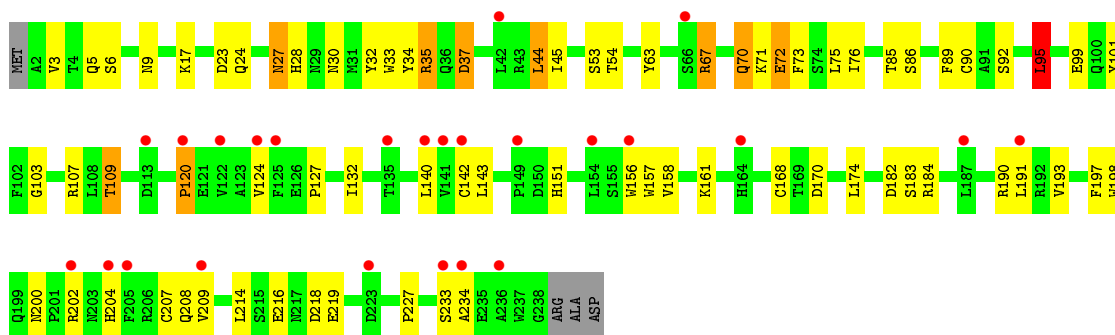

- Molecule 4: 8F10 beta chain

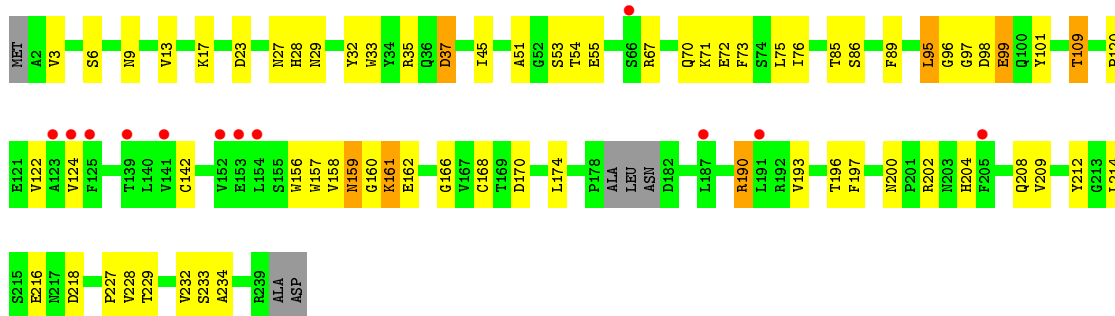

4 Data and refinement statistics

Property	Value	Source
Space group	P 1 21 1	Depositor
Cell constants a, b, c, α , β , γ	93.09Å 102.04Å 136.00Å 90.00° 107.83° 90.00°	Depositor
Resolution (Å)	50.01 – 3.20 46.51 – 3.20	Depositor EDS
% Data completeness (in resolution range)	96.7 (50.01-3.20) 86.8 (46.51-3.20)	Depositor EDS
R_{merge}	(Not available)	Depositor
R_{sym}	(Not available)	Depositor
$\langle I/\sigma(I) \rangle$ ¹	1.52 (at 3.19Å)	Xtrriage
Refinement program	REFMAC 5.8.0135	Depositor
R, R_{free}	0.233 , 0.297 0.239 , 0.301	Depositor DCC
R_{free} test set	1981 reflections (5.09%)	wwPDB-VP
Wilson B-factor (Å ²)	94.4	Xtrriage
Anisotropy	0.767	Xtrriage
Bulk solvent k_{sol} (e/Å ³), B_{sol} (Å ²)	0.29 , 75.3	EDS
L-test for twinning ²	$\langle L \rangle = 0.46$, $\langle L^2 \rangle = 0.29$	Xtrriage
Estimated twinning fraction	0.089 for h,-k,-h-l	Xtrriage
F_o, F_c correlation	0.94	EDS
Total number of atoms	12219	wwPDB-VP
Average B, all atoms (Å ²)	133.0	wwPDB-VP

Xtrriage's analysis on translational NCS is as follows: *The largest off-origin peak in the Patterson function is 3.66% of the height of the origin peak. No significant pseudotranslation is detected.*

¹ Intensities estimated from amplitudes.

² Theoretical values of $\langle |L| \rangle$, $\langle L^2 \rangle$ for acentric reflections are 0.5, 0.333 respectively for untwinned datasets, and 0.375, 0.2 for perfectly twinned datasets.

5 Model quality i

5.1 Standard geometry i

The Z score for a bond length (or angle) is the number of standard deviations the observed value is removed from the expected value. A bond length (or angle) with $|Z| > 5$ is considered an outlier worth inspection. RMSZ is the root-mean-square of all Z scores of the bond lengths (or angles).

Mol	Chain	Bond lengths		Bond angles	
		RMSZ	# Z >5	RMSZ	# Z >5
1	A	1.56	13/1535 (0.8%)	1.29	9/2096 (0.4%)
1	C	1.45	16/1523 (1.1%)	1.22	10/2080 (0.5%)
2	B	1.54	16/1631 (1.0%)	1.29	7/2207 (0.3%)
2	D	1.41	14/1620 (0.9%)	1.19	11/2194 (0.5%)
3	E	0.81	0/1095	1.01	3/1478 (0.2%)
3	G	0.75	0/1407	0.89	0/1897
4	F	0.65	0/1862	0.81	2/2543 (0.1%)
4	H	0.68	1/1857 (0.1%)	0.81	0/2531
All	All	1.17	60/12530 (0.5%)	1.08	42/17026 (0.2%)

Chiral center outliers are detected by calculating the chiral volume of a chiral center and verifying if the center is modelled as a planar moiety or with the opposite hand. A planarity outlier is detected by checking planarity of atoms in a peptide group, atoms in a mainchain group or atoms of a sidechain that are expected to be planar.

Mol	Chain	#Chirality outliers	#Planarity outliers
1	A	0	2
1	C	0	3
2	B	0	1
2	D	0	3
All	All	0	9

The worst 5 of 60 bond length outliers are listed below:

Mol	Chain	Res	Type	Atoms	Z	Observed(Å)	Ideal(Å)
2	B	6	ARG	NE-CZ	18.69	1.57	1.33
2	D	179	SER	CB-OG	16.44	1.63	1.42
1	A	102	GLY	C-O	15.88	1.49	1.23
2	B	179	SER	CB-OG	15.22	1.62	1.42
2	B	95	GLU	CG-CD	12.40	1.70	1.51

The worst 5 of 42 bond angle outliers are listed below:

Mol	Chain	Res	Type	Atoms	Z	Observed(°)	Ideal(°)
2	B	6	ARG	NE-CZ-NH1	14.14	127.37	120.30
2	B	152	ASP	CB-CG-OD2	-12.26	107.26	118.30
2	D	6	ARG	NE-CZ-NH1	11.10	125.85	120.30
2	D	149	ARG	NE-CZ-NH2	-9.60	115.50	120.30
1	A	152	TYR	CB-CG-CD1	8.37	126.02	121.00

There are no chirality outliers.

5 of 9 planarity outliers are listed below:

Mol	Chain	Res	Type	Group
1	A	102	GLY	Mainchain
1	A	117	PRO	Peptide
2	B	67	LEU	Peptide
1	C	117	PRO	Peptide
1	C	150	LEU	Mainchain

5.2 Too-close contacts [i](#)

In the following table, the Non-H and H(model) columns list the number of non-hydrogen atoms and hydrogen atoms in the chain respectively. The H(added) column lists the number of hydrogen atoms added and optimized by MolProbity. The Clashes column lists the number of clashes within the asymmetric unit, whereas Symm-Clashes lists symmetry related clashes.

Mol	Chain	Non-H	H(model)	H(added)	Clashes	Symm-Clashes
1	A	1489	0	1418	100	0
1	C	1477	0	1402	95	0
2	B	1595	0	1532	73	0
2	D	1584	0	1510	64	0
3	E	1075	0	1015	48	0
3	G	1381	0	1313	39	0
4	F	1811	0	1687	39	0
4	H	1807	0	1694	39	0
All	All	12219	0	11571	442	0

The all-atom clashscore is defined as the number of clashes found per 1000 atoms (including hydrogen atoms). The all-atom clashscore for this structure is 19.

The worst 5 of 442 close contacts within the same asymmetric unit are listed below, sorted by their clash magnitude.

Atom-1	Atom-2	Interatomic distance (Å)	Clash overlap (Å)
1:C:74:ILE:CG1	1:C:74:ILE:CD1	1.76	1.53

Continued on next page...

Continued from previous page...

Atom-1	Atom-2	Interatomic distance (Å)	Clash overlap (Å)
2:D:179:SER:CB	2:D:179:SER:OG	1.63	1.43
3:E:31:ASN:HD22	3:E:95:ARG:HB3	1.17	1.05
1:A:17:SER:OG	1:A:18:PRO:HA	1.61	1.00
3:E:31:ASN:HD22	3:E:95:ARG:CB	1.75	0.99

There are no symmetry-related clashes.

5.3 Torsion angles [i](#)

5.3.1 Protein backbone [i](#)

In the following table, the Percentiles column shows the percent Ramachandran outliers of the chain as a percentile score with respect to all X-ray entries followed by that with respect to entries of similar resolution.

The Analysed column shows the number of residues for which the backbone conformation was analysed, and the total number of residues.

Mol	Chain	Analysed	Favoured	Allowed	Outliers	Percentiles	
1	A	182/183 (100%)	141 (78%)	29 (16%)	12 (7%)	1	9
1	C	181/183 (99%)	144 (80%)	27 (15%)	10 (6%)	2	14
2	B	186/221 (84%)	144 (77%)	26 (14%)	16 (9%)	1	4
2	D	186/221 (84%)	143 (77%)	32 (17%)	11 (6%)	1	12
3	E	131/210 (62%)	104 (79%)	16 (12%)	11 (8%)	1	5
3	G	164/210 (78%)	126 (77%)	24 (15%)	14 (8%)	1	4
4	F	235/241 (98%)	205 (87%)	23 (10%)	7 (3%)	4	28
4	H	231/241 (96%)	198 (86%)	29 (13%)	4 (2%)	9	42
All	All	1496/1710 (88%)	1205 (80%)	206 (14%)	85 (6%)	1	14

5 of 85 Ramachandran outliers are listed below:

Mol	Chain	Res	Type
1	A	29	ASP
1	A	78	ARG
2	B	67	LEU
2	B	95	GLU
2	B	97	PRO

5.3.2 Protein sidechains [i](#)

In the following table, the Percentiles column shows the percent sidechain outliers of the chain as a percentile score with respect to all X-ray entries followed by that with respect to entries of similar resolution.

The Analysed column shows the number of residues for which the sidechain conformation was analysed, and the total number of residues.

Mol	Chain	Analysed	Rotameric	Outliers	Percentiles	
1	A	166/165 (101%)	128 (77%)	38 (23%)	1	4
1	C	164/165 (99%)	127 (77%)	37 (23%)	1	4
2	B	174/191 (91%)	145 (83%)	29 (17%)	2	10
2	D	172/191 (90%)	150 (87%)	22 (13%)	4	20
3	E	118/189 (62%)	98 (83%)	20 (17%)	2	10
3	G	155/189 (82%)	122 (79%)	33 (21%)	1	5
4	F	185/205 (90%)	161 (87%)	24 (13%)	4	19
4	H	186/205 (91%)	160 (86%)	26 (14%)	3	16
All	All	1320/1500 (88%)	1091 (83%)	229 (17%)	2	10

5 of 229 residues with a non-rotameric sidechain are listed below:

Mol	Chain	Res	Type
4	F	161	LYS
1	C	96	LYS
4	H	54	THR
4	F	174	LEU
1	C	33	LEU

Some sidechains can be flipped to improve hydrogen bonding and reduce clashes. 5 of 39 such sidechains are listed below:

Mol	Chain	Res	Type
4	F	203	ASN
1	C	90	GLN
4	H	199	GLN
1	C	26	HIS
1	C	59	GLN

5.3.3 RNA [i](#)

There are no RNA molecules in this entry.

5.4 Non-standard residues in protein, DNA, RNA chains [i](#)

There are no non-standard protein/DNA/RNA residues in this entry.

5.5 Carbohydrates [i](#)

There are no carbohydrates in this entry.

5.6 Ligand geometry [i](#)

There are no ligands in this entry.

5.7 Other polymers [i](#)

There are no such residues in this entry.

5.8 Polymer linkage issues [i](#)

There are no chain breaks in this entry.

6 Fit of model and data [i](#)

6.1 Protein, DNA and RNA chains [i](#)

In the following table, the column labelled ‘#RSRZ> 2’ contains the number (and percentage) of RSRZ outliers, followed by percent RSRZ outliers for the chain as percentile scores relative to all X-ray entries and entries of similar resolution. The OWAB column contains the minimum, median, 95th percentile and maximum values of the occupancy-weighted average B-factor per residue. The column labelled ‘Q< 0.9’ lists the number of (and percentage) of residues with an average occupancy less than 0.9.

Mol	Chain	Analysed	<RSRZ>	#RSRZ>2	OWAB(Å ²)	Q<0.9
1	A	182/183 (99%)	0.09	0 100 100	71, 93, 126, 142	0
1	C	182/183 (99%)	0.10	2 (1%) 80 69	79, 98, 130, 149	0
2	B	192/221 (86%)	0.04	2 (1%) 82 72	80, 114, 147, 174	0
2	D	192/221 (86%)	0.07	3 (1%) 72 59	87, 125, 154, 168	0
3	E	139/210 (66%)	0.47	16 (11%) 4 3	126, 154, 196, 206	0
3	G	177/210 (84%)	0.21	7 (3%) 38 25	134, 157, 178, 192	0
4	F	237/241 (98%)	0.44	25 (10%) 6 3	120, 167, 208, 227	1 (0%)
4	H	235/241 (97%)	0.11	12 (5%) 28 16	113, 151, 181, 193	0
All	All	1536/1710 (89%)	0.19	67 (4%) 34 21	71, 136, 188, 227	1 (0%)

The worst 5 of 67 RSRZ outliers are listed below:

Mol	Chain	Res	Type	RSRZ
4	H	124	VAL	6.2
3	E	140	LEU	5.7
4	F	234	ALA	5.6
4	F	120	PRO	4.8
4	F	125	PHE	4.7

6.2 Non-standard residues in protein, DNA, RNA chains [i](#)

There are no non-standard protein/DNA/RNA residues in this entry.

6.3 Carbohydrates [i](#)

There are no carbohydrates in this entry.

6.4 Ligands

There are no ligands in this entry.

6.5 Other polymers

There are no such residues in this entry.