



# wwPDB X-ray Structure Validation Summary Report

Sep 25, 2023 – 04:06 PM EDT

PDB ID : 6AVM  
Title : STRUCTURE OF HIV-1 REVERSE TRANSCRIPTASE (RT) TERNARY COMPLEX WITH A DOUBLE STRANDED DNA AND AN INCOMING D4TTP AT PH 9.5 WITH CROSS-LINKING TO SECOND BASE TEMPLATE OVERHANG  
Authors : Martinez, S.E.; Das, K.; Arnold, E.  
Deposited on : 2017-09-03  
Resolution : 2.50 Å(reported)

This is a wwPDB X-ray Structure Validation Summary Report for a publicly released PDB entry.

We welcome your comments at [validation@mail.wwpdb.org](mailto:validation@mail.wwpdb.org)

A user guide is available at

<https://www.wwpdb.org/validation/2017/XrayValidationReportHelp>

with specific help available everywhere you see the  symbol.

The types of validation reports are described at

<http://www.wwpdb.org/validation/2017/FAQs#types>.

---

The following versions of software and data (see [references](#) ①) were used in the production of this report:

MolProbity : 4.02b-467  
Mogul : 1.8.5 (274361), CSD as541be (2020)  
Xtrriage (Phenix) : 1.13  
EDS : 2.35.1  
buster-report : 1.1.7 (2018)  
Percentile statistics : 20191225.v01 (using entries in the PDB archive December 25th 2019)  
Refmac : 5.8.0158  
CCP4 : 7.0.044 (Gargrove)  
Ideal geometry (proteins) : Engh & Huber (2001)  
Ideal geometry (DNA, RNA) : Parkinson et al. (1996)  
Validation Pipeline (wwPDB-VP) : 2.35.1

# 1 Overall quality at a glance

The following experimental techniques were used to determine the structure:

*X-RAY DIFFRACTION*

The reported resolution of this entry is 2.50 Å.

Percentile scores (ranging between 0-100) for global validation metrics of the entry are shown in the following graphic. The table shows the number of entries on which the scores are based.

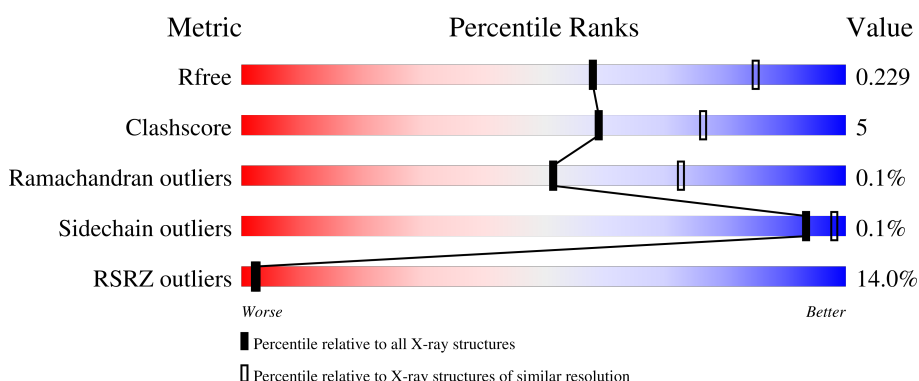



Metric	Whole archive (#Entries)	Similar resolution (#Entries, resolution range(Å))
$R_{free}$	130704	4661 (2.50-2.50)
Clashscore	141614	5346 (2.50-2.50)
Ramachandran outliers	138981	5231 (2.50-2.50)
Sidechain outliers	138945	5233 (2.50-2.50)
RSRZ outliers	127900	4559 (2.50-2.50)

The table below summarises the geometric issues observed across the polymeric chains and their fit to the electron density. The red, orange, yellow and green segments of the lower bar indicate the fraction of residues that contain outliers for  $\geq 3$ , 2, 1 and 0 types of geometric quality criteria respectively. A grey segment represents the fraction of residues that are not modelled. The numeric value for each fraction is indicated below the corresponding segment, with a dot representing fractions  $\leq 5\%$ . The upper red bar (where present) indicates the fraction of residues that have poor fit to the electron density. The numeric value is given above the bar.

Mol	Chain	Length	Quality of chain
1	A	556	
1	C	556	
2	B	444	
2	D	444	
3	E	27	

*Continued on next page...*

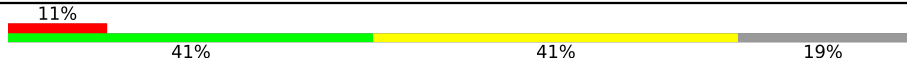
*Continued from previous page...*

Mol	Chain	Length	Quality of chain
3	T	27	
4	F	21	
4	P	21	

The following table lists non-polymeric compounds, carbohydrate monomers and non-standard residues in protein, DNA, RNA chains that are outliers for geometric or electron-density-fit criteria:

Mol	Type	Chain	Res	Chirality	Geometry	Clashes	Electron density
7	GOL	D	503	-	-	-	X

## 2 Entry composition [i](#)

There are 8 unique types of molecules in this entry. The entry contains 18287 atoms, of which 0 are hydrogens and 0 are deuteriums.

In the tables below, the ZeroOcc column contains the number of atoms modelled with zero occupancy, the AltConf column contains the number of residues with at least one atom in alternate conformation and the Trace column contains the number of residues modelled with at most 2 atoms.

- Molecule 1 is a protein called HIV-1 REVERSE TRANSCRIPTASE P66 SUBUNIT.

Mol	Chain	Residues	Atoms					ZeroOcc	AltConf	Trace
			Total	C	N	O	S			
1	A	555	Total	C	N	O	S	0	0	0
			4517	2923	751	834	9			
1	C	555	Total	C	N	O	S	0	0	0
			4517	2923	751	834	9			

There are 8 discrepancies between the modelled and reference sequences:

Chain	Residue	Modelled	Actual	Comment	Reference
A	-1	MET	-	initiating methionine	UNP P03366
A	0	VAL	-	expression tag	UNP P03366
A	63	CYS	ILE	engineered mutation	UNP P03366
A	280	SER	CYS	engineered mutation	UNP P03366
C	-1	MET	-	initiating methionine	UNP P03366
C	0	VAL	-	expression tag	UNP P03366
C	63	CYS	ILE	engineered mutation	UNP P03366
C	280	SER	CYS	engineered mutation	UNP P03366

- Molecule 2 is a protein called HIV-1 REVERSE TRANSCRIPTASE P51 SUBUNIT.

Mol	Chain	Residues	Atoms					ZeroOcc	AltConf	Trace
			Total	C	N	O	S			
2	B	412	Total	C	N	O	S	0	0	0
			3415	2227	564	617	7			
2	D	402	Total	C	N	O	S	0	0	0
			3329	2169	548	607	5			

There are 34 discrepancies between the modelled and reference sequences:

Chain	Residue	Modelled	Actual	Comment	Reference
B	-15	MET	-	initiating methionine	UNP P03366
B	-14	ALA	-	expression tag	UNP P03366
B	-13	HIS	-	expression tag	UNP P03366
B	-12	HIS	-	expression tag	UNP P03366

*Continued on next page...*

Continued from previous page...

Chain	Residue	Modelled	Actual	Comment	Reference
B	-11	HIS	-	expression tag	UNP P03366
B	-10	HIS	-	expression tag	UNP P03366
B	-9	HIS	-	expression tag	UNP P03366
B	-8	HIS	-	expression tag	UNP P03366
B	-7	ALA	-	expression tag	UNP P03366
B	-6	LEU	-	expression tag	UNP P03366
B	-5	GLU	-	expression tag	UNP P03366
B	-4	VAL	-	expression tag	UNP P03366
B	-3	LEU	-	expression tag	UNP P03366
B	-2	PHE	-	expression tag	UNP P03366
B	-1	GLN	-	expression tag	UNP P03366
B	0	GLY	-	expression tag	UNP P03366
B	280	SER	CYS	engineered mutation	UNP P03366
D	-15	MET	-	initiating methionine	UNP P03366
D	-14	ALA	-	expression tag	UNP P03366
D	-13	HIS	-	expression tag	UNP P03366
D	-12	HIS	-	expression tag	UNP P03366
D	-11	HIS	-	expression tag	UNP P03366
D	-10	HIS	-	expression tag	UNP P03366
D	-9	HIS	-	expression tag	UNP P03366
D	-8	HIS	-	expression tag	UNP P03366
D	-7	ALA	-	expression tag	UNP P03366
D	-6	LEU	-	expression tag	UNP P03366
D	-5	GLU	-	expression tag	UNP P03366
D	-4	VAL	-	expression tag	UNP P03366
D	-3	LEU	-	expression tag	UNP P03366
D	-2	PHE	-	expression tag	UNP P03366
D	-1	GLN	-	expression tag	UNP P03366
D	0	GLY	-	expression tag	UNP P03366
D	280	SER	CYS	engineered mutation	UNP P03366

- Molecule 3 is a DNA chain called DNA (27-MER).

Mol	Chain	Residues	Atoms					ZeroOcc	AltConf	Trace
3	T	22	Total	C	N	O	P	0	0	0
			455	213	93	127	22			
3	E	22	Total	C	N	O	P	0	0	0
			455	213	93	127	22			

- Molecule 4 is a DNA chain called DNA (5'-D(\*A\*CP\*AP\*GP\*TP\*CP\*CP\*CP\*TP\*GP\*TP\*TP\*CP\*GP\*GP\*GP\*CP\*GP\*CP\*CP\*(DDG))-3').

Mol	Chain	Residues	Atoms					ZeroOcc	AltConf	Trace
4	P	20	Total	C	N	O	P	0	0	0
			403	192	72	120	19			
4	F	20	Total	C	N	O	P	0	0	0
			403	192	72	120	19			

- Molecule 5 is MAGNESIUM ION (three-letter code: MG) (formula: Mg).

Mol	Chain	Residues	Atoms		ZeroOcc	AltConf
5	A	2	Total	Mg	0	0
			2	2		
5	C	2	Total	Mg	0	0
			2	2		

- Molecule 6 is 2',3'-DEHYDRO-2',3'-DEOXY-THYMIDINE 5'-TRIPHOSPHATE (three-letter code: D4T) (formula: C<sub>10</sub>H<sub>15</sub>N<sub>2</sub>O<sub>13</sub>P<sub>3</sub>).

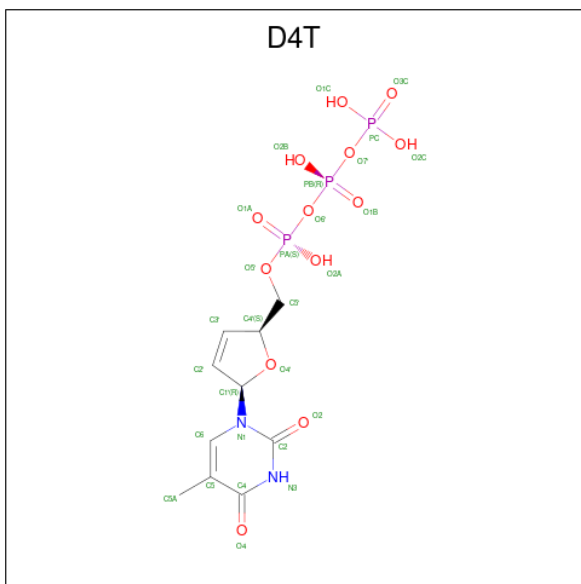

Mol	Chain	Residues	Atoms					ZeroOcc	AltConf
6	A	1	Total	C	N	O	P	0	0
			28	10	2	13	3		
6	C	1	Total	C	N	O	P	0	0
			28	10	2	13	3		

- Molecule 7 is GLYCEROL (three-letter code: GOL) (formula: C<sub>3</sub>H<sub>8</sub>O<sub>3</sub>).



Mol	Chain	Residues	Atoms	ZeroOcc	AltConf
7	A	1	Total C O 6 3 3	0	0
7	B	1	Total C O 6 3 3	0	0
7	B	1	Total C O 6 3 3	0	0
7	B	1	Total C O 6 3 3	0	0
7	B	1	Total C O 6 3 3	0	0
7	B	1	Total C O 6 3 3	0	0
7	B	1	Total C O 6 3 3	0	0
7	C	1	Total C O 6 3 3	0	0
7	C	1	Total C O 6 3 3	0	0
7	D	1	Total C O 6 3 3	0	0
7	D	1	Total C O 6 3 3	0	0
7	D	1	Total C O 6 3 3	0	0

- Molecule 8 is water.



Mol	Chain	Residues	Atoms	ZeroOcc	AltConf
8	A	175	Total O 175 175	0	0
8	B	182	Total O 182 182	0	0
8	T	17	Total O 17 17	0	0
8	P	13	Total O 13 13	0	0
8	C	143	Total O 143 143	0	0
8	D	108	Total O 108 108	0	0
8	E	6	Total O 6 6	0	0
8	F	17	Total O 17 17	0	0

### 3 Residue-property plots [i](#)

These plots are drawn for all protein, RNA, DNA and oligosaccharide chains in the entry. The first graphic for a chain summarises the proportions of the various outlier classes displayed in the second graphic. The second graphic shows the sequence view annotated by issues in geometry and electron density. Residues are color-coded according to the number of geometric quality criteria for which they contain at least one outlier: green = 0, yellow = 1, orange = 2 and red = 3 or more. A red dot above a residue indicates a poor fit to the electron density ( $RSRZ > 2$ ). Stretches of 2 or more consecutive residues without any outlier are shown as a green connector. Residues present in the sample, but not in the model, are shown in grey.

- Molecule 1: HIV-1 REVERSE TRANSCRIPTASE P66 SUBUNIT

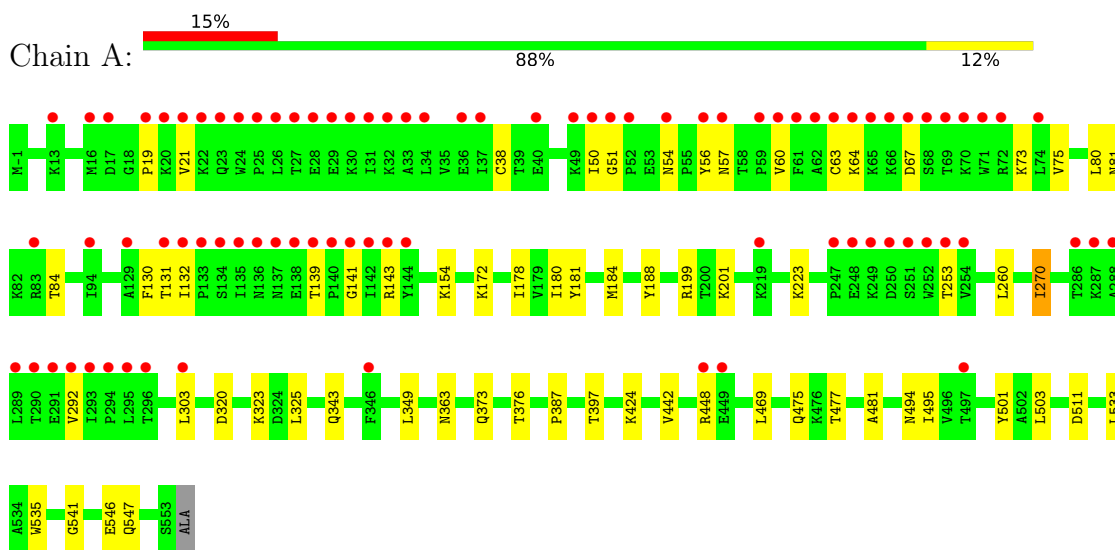

- Molecule 1: HIV-1 REVERSE TRANSCRIPTASE P66 SUBUNIT

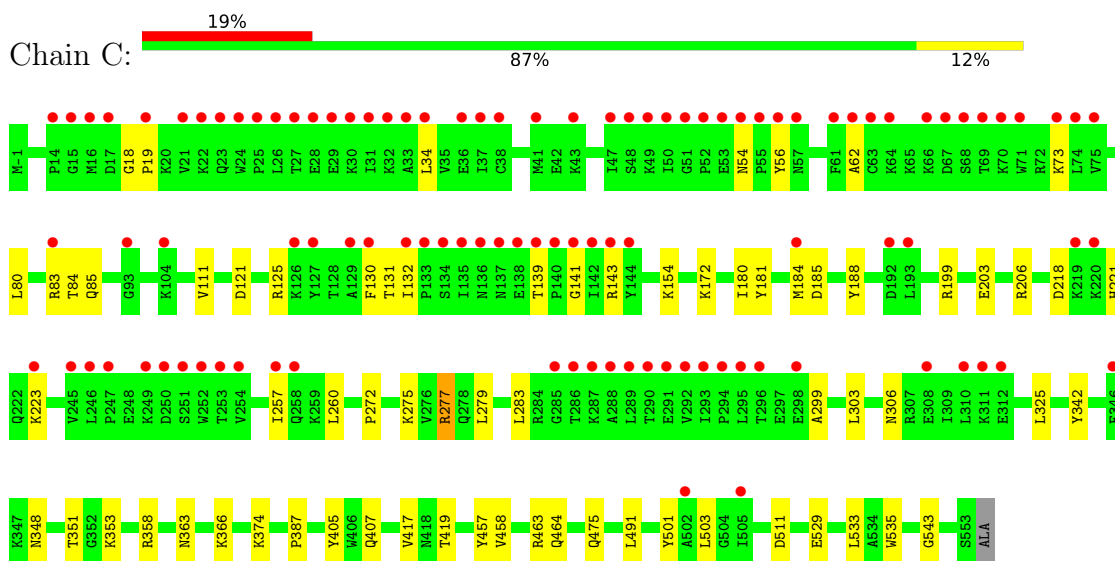

- Molecule 2: HIV-1 REVERSE TRANSCRIPTASE P51 SUBUNIT

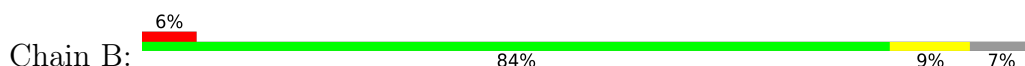

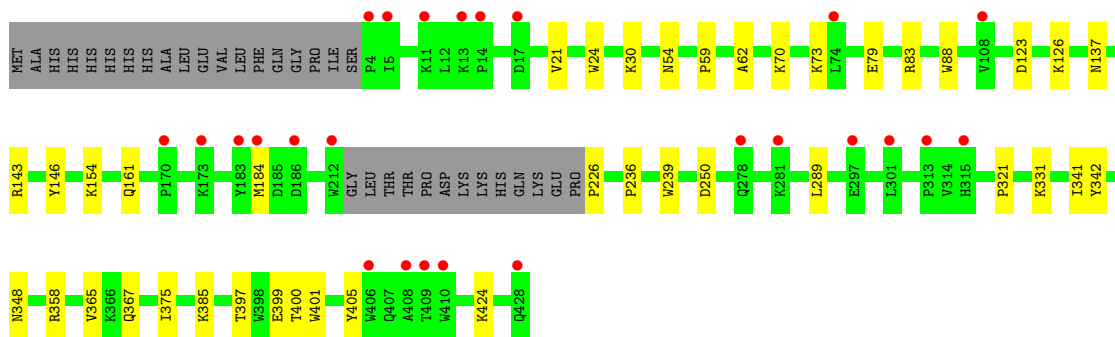

- Molecule 2: HIV-1 REVERSE TRANSCRIPTASE P51 SUBUNIT

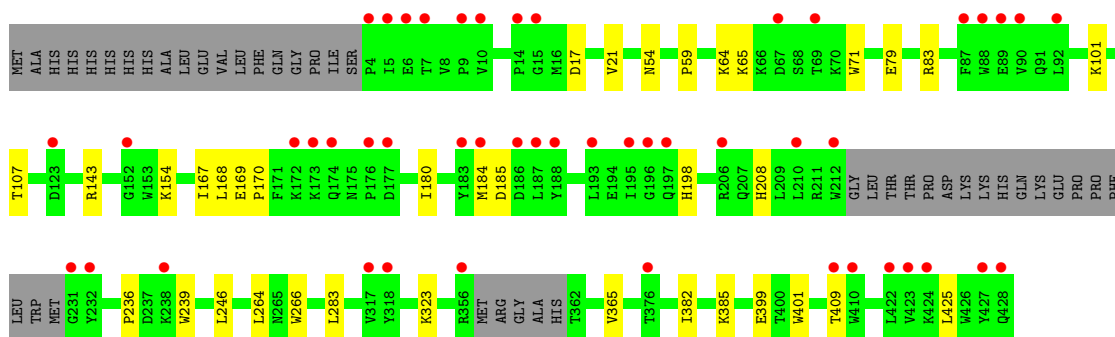
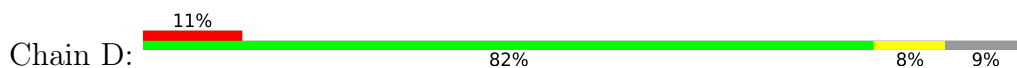

- Molecule 3: DNA (27-MER)

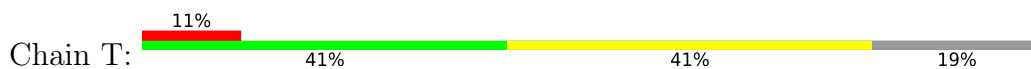

- Molecule 3: DNA (27-MER)



- Molecule 4: DNA (5'-D(\*A\*CP\*AP\*GP\*TP\*CP\*CP\*CP\*TP\*GP\*TP\*TP\*CP\*GP\*GP\*GP\*CP\*GP\*CP\*CP\*(DDG))-3')



- Molecule 4: DNA (5'-D(\*A\*CP\*AP\*GP\*TP\*CP\*CP\*CP\*TP\*GP\*TP\*TP\*CP\*GP\*GP\*GP\*CP\*GP\*CP\*CP\*(DDG))-3')

Chain F:  24% 48% 43% 5% 5%

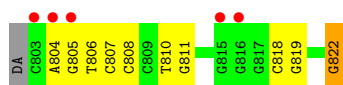

## 4 Data and refinement statistics

Property	Value	Source
Space group	P 1 21 1	Depositor
Cell constants a, b, c, $\alpha$ , $\beta$ , $\gamma$	90.26Å 133.33Å 140.20Å 90.00° 97.63° 90.00°	Depositor
Resolution (Å)	34.37 – 2.50 34.37 – 2.50	Depositor EDS
% Data completeness (in resolution range)	98.9 (34.37-2.50) 96.8 (34.37-2.50)	Depositor EDS
$R_{merge}$	0.10	Depositor
$R_{sym}$	(Not available)	Depositor
$\langle I/\sigma(I) \rangle$ <sup>1</sup>	1.70 (at 2.51Å)	Xtrriage
Refinement program	PHENIX 1.11.1 2575	Depositor
R, $R_{free}$	0.191 , 0.229 0.191 , 0.229	Depositor DCC
$R_{free}$ test set	2003 reflections (1.79%)	wwPDB-VP
Wilson B-factor (Å <sup>2</sup> )	51.5	Xtrriage
Anisotropy	0.295	Xtrriage
Bulk solvent $k_{sol}$ (e/Å <sup>3</sup> ), $B_{sol}$ (Å <sup>2</sup> )	0.31 , 69.9	EDS
L-test for twinning <sup>2</sup>	$\langle  L  \rangle = 0.49$ , $\langle L^2 \rangle = 0.32$	Xtrriage
Estimated twinning fraction	No twinning to report.	Xtrriage
$F_o, F_c$ correlation	0.95	EDS
Total number of atoms	18287	wwPDB-VP
Average B, all atoms (Å <sup>2</sup> )	92.0	wwPDB-VP

Xtrriage's analysis on translational NCS is as follows: *The largest off-origin peak in the Patterson function is 2.95% of the height of the origin peak. No significant pseudotranslation is detected.*

<sup>1</sup>Intensities estimated from amplitudes.

<sup>2</sup>Theoretical values of  $\langle |L| \rangle$ ,  $\langle L^2 \rangle$  for acentric reflections are 0.5, 0.333 respectively for untwinned datasets, and 0.375, 0.2 for perfectly twinned datasets.

## 5 Model quality [i](#)

### 5.1 Standard geometry [i](#)

Bond lengths and bond angles in the following residue types are not validated in this section: MG, D4T, GOL, DDG

The Z score for a bond length (or angle) is the number of standard deviations the observed value is removed from the expected value. A bond length (or angle) with  $|Z| > 5$  is considered an outlier worth inspection. RMSZ is the root-mean-square of all Z scores of the bond lengths (or angles).

Mol	Chain	Bond lengths		Bond angles	
		RMSZ	# Z  >5	RMSZ	# Z  >5
1	A	0.24	0/4635	0.41	0/6297
1	C	0.24	0/4635	0.41	0/6297
2	B	0.24	0/3515	0.40	0/4774
2	D	0.24	0/3423	0.40	0/4649
3	E	0.46	0/512	0.73	0/788
3	T	0.47	0/512	0.73	0/788
4	F	0.51	0/426	0.84	0/655
4	P	0.50	0/426	0.87	0/655
All	All	0.27	0/18084	0.47	0/24903

There are no bond length outliers.

There are no bond angle outliers.

There are no chirality outliers.

There are no planarity outliers.

### 5.2 Too-close contacts [i](#)

In the following table, the Non-H and H(model) columns list the number of non-hydrogen atoms and hydrogen atoms in the chain respectively. The H(added) column lists the number of hydrogen atoms added and optimized by MolProbity. The Clashes column lists the number of clashes within the asymmetric unit, whereas Symm-Clashes lists symmetry-related clashes.

Mol	Chain	Non-H	H(model)	H(added)	Clashes	Symm-Clashes
1	A	4517	0	4577	39	0
1	C	4517	0	4577	42	0
2	B	3415	0	3445	28	0
2	D	3329	0	3360	22	0
3	E	455	0	244	5	0

*Continued on next page...*

*Continued from previous page...*

Mol	Chain	Non-H	H(model)	H(added)	Clashes	Symm-Clashes
3	T	455	0	244	7	0
4	F	403	0	226	9	0
4	P	403	0	226	14	0
5	A	2	0	0	0	0
5	C	2	0	0	0	0
6	A	28	0	11	0	0
6	C	28	0	11	0	0
7	A	6	0	8	1	0
7	B	36	0	48	7	0
7	C	12	0	16	0	0
7	D	18	0	24	1	0
8	A	175	0	0	2	0
8	B	182	0	0	3	0
8	C	143	0	0	6	0
8	D	108	0	0	3	0
8	E	6	0	0	0	0
8	F	17	0	0	0	0
8	P	13	0	0	1	0
8	T	17	0	0	1	0
All	All	18287	0	17017	158	0

The all-atom clashscore is defined as the number of clashes found per 1000 atoms (including hydrogen atoms). The all-atom clashscore for this structure is 5.

The worst 5 of 158 close contacts within the same asymmetric unit are listed below, sorted by their clash magnitude.

Atom-1	Atom-2	Interatomic distance (Å)	Clash overlap (Å)
2:B:367:GLN:HE22	7:B:505:GOL:H11	1.37	0.90
1:A:547:GLN:NE2	8:A:701:HOH:O	2.21	0.72
1:A:131:THR:HG22	1:A:143:ARG:HB3	1.72	0.71
1:C:54:ASN:HB3	1:C:143:ARG:HH12	1.55	0.71
1:C:131:THR:HG22	1:C:143:ARG:HB3	1.72	0.71

There are no symmetry-related clashes.

## 5.3 Torsion angles [i](#)

### 5.3.1 Protein backbone [i](#)

In the following table, the Percentiles column shows the percent Ramachandran outliers of the chain as a percentile score with respect to all X-ray entries followed by that with respect to entries of similar resolution.

The Analysed column shows the number of residues for which the backbone conformation was analysed, and the total number of residues.

Mol	Chain	Analysed	Favoured	Allowed	Outliers	Percentiles	
1	A	553/556 (100%)	527 (95%)	24 (4%)	2 (0%)	34	54
1	C	553/556 (100%)	534 (97%)	19 (3%)	0	100	100
2	B	408/444 (92%)	394 (97%)	14 (3%)	0	100	100
2	D	396/444 (89%)	384 (97%)	12 (3%)	0	100	100
All	All	1910/2000 (96%)	1839 (96%)	69 (4%)	2 (0%)	51	73

All (2) Ramachandran outliers are listed below:

Mol	Chain	Res	Type
1	A	67	ASP
1	A	270	ILE

### 5.3.2 Protein sidechains [i](#)

In the following table, the Percentiles column shows the percent sidechain outliers of the chain as a percentile score with respect to all X-ray entries followed by that with respect to entries of similar resolution.

The Analysed column shows the number of residues for which the sidechain conformation was analysed, and the total number of residues.

Mol	Chain	Analysed	Rotameric	Outliers	Percentiles	
1	A	497/497 (100%)	497 (100%)	0	100	100
1	C	497/497 (100%)	496 (100%)	1 (0%)	93	98
2	B	375/403 (93%)	375 (100%)	0	100	100
2	D	367/403 (91%)	366 (100%)	1 (0%)	92	97
All	All	1736/1800 (96%)	1734 (100%)	2 (0%)	93	98

All (2) residues with a non-rotameric sidechain are listed below:



Mol	Chain	Res	Type
1	C	277	ARG
2	D	185	ASP

Sometimes sidechains can be flipped to improve hydrogen bonding and reduce clashes. All (3) such sidechains are listed below:

Mol	Chain	Res	Type
1	A	373	GLN
1	A	487	GLN
2	B	137	ASN

### 5.3.3 RNA [i](#)

There are no RNA molecules in this entry.

## 5.4 Non-standard residues in protein, DNA, RNA chains [i](#)

2 non-standard protein/DNA/RNA residues are modelled in this entry.

In the following table, the Counts columns list the number of bonds (or angles) for which Mogul statistics could be retrieved, the number of bonds (or angles) that are observed in the model and the number of bonds (or angles) that are defined in the Chemical Component Dictionary. The Link column lists molecule types, if any, to which the group is linked. The Z score for a bond length (or angle) is the number of standard deviations the observed value is removed from the expected value. A bond length (or angle) with  $|Z| > 2$  is considered an outlier worth inspection. RMSZ is the root-mean-square of all Z scores of the bond lengths (or angles).

Mol	Type	Chain	Res	Link	Bond lengths			Bond angles		
					Counts	RMSZ	# Z  > 2	Counts	RMSZ	# Z  > 2
4	DDG	F	822	3,4	17,23,24	4.11	10 (58%)	15,33,36	2.11	6 (40%)
4	DDG	P	822	3,4	17,23,24	4.09	11 (64%)	15,33,36	2.08	6 (40%)

In the following table, the Chirals column lists the number of chiral outliers, the number of chiral centers analysed, the number of these observed in the model and the number defined in the Chemical Component Dictionary. Similar counts are reported in the Torsion and Rings columns. '-' means no outliers of that kind were identified.

Mol	Type	Chain	Res	Link	Chirals	Torsions	Rings
4	DDG	F	822	3,4	-	0/3/18/19	0/3/3/3
4	DDG	P	822	3,4	-	0/3/18/19	0/3/3/3

The worst 5 of 21 bond length outliers are listed below:

Mol	Chain	Res	Type	Atoms	Z	Observed(Å)	Ideal(Å)
4	P	822	DDG	C2'-C3'	-9.67	1.27	1.54
4	F	822	DDG	C2'-C3'	-9.66	1.27	1.54
4	F	822	DDG	O4'-C4'	-7.94	1.28	1.44
4	P	822	DDG	O4'-C4'	-7.77	1.29	1.44
4	F	822	DDG	C1'-N9	-6.00	1.31	1.49

The worst 5 of 12 bond angle outliers are listed below:

Mol	Chain	Res	Type	Atoms	Z	Observed(°)	Ideal(°)
4	F	822	DDG	C4'-O4'-C1'	-4.13	105.91	109.81
4	P	822	DDG	C4'-O4'-C1'	-3.70	106.32	109.81
4	F	822	DDG	C5-C6-N1	3.32	119.82	113.95
4	P	822	DDG	C5-C6-N1	3.14	119.49	113.95
4	F	822	DDG	C2-N1-C6	-2.94	119.68	125.10

There are no chirality outliers.

There are no torsion outliers.

There are no ring outliers.

2 monomers are involved in 2 short contacts:

Mol	Chain	Res	Type	Clashes	Symm-Clashes
4	F	822	DDG	1	0
4	P	822	DDG	1	0

## 5.5 Carbohydrates [i](#)

There are no monosaccharides in this entry.

## 5.6 Ligand geometry [i](#)

Of 18 ligands modelled in this entry, 4 are monoatomic - leaving 14 for Mogul analysis.

In the following table, the Counts columns list the number of bonds (or angles) for which Mogul statistics could be retrieved, the number of bonds (or angles) that are observed in the model and the number of bonds (or angles) that are defined in the Chemical Component Dictionary. The Link column lists molecule types, if any, to which the group is linked. The Z score for a bond length (or angle) is the number of standard deviations the observed value is removed from the expected value. A bond length (or angle) with  $|Z| > 2$  is considered an outlier worth inspection. RMSZ is the root-mean-square of all Z scores of the bond lengths (or angles).

Mol	Type	Chain	Res	Link	Bond lengths			Bond angles		
					Counts	RMSZ	# Z  > 2	Counts	RMSZ	# Z  > 2
7	GOL	B	501	-	5,5,5	0.38	0	5,5,5	0.20	0
7	GOL	C	605	-	5,5,5	0.38	0	5,5,5	0.29	0
6	D4T	C	603	5	22,29,29	1.23	3 (13%)	27,45,45	1.66	4 (14%)
7	GOL	D	502	-	5,5,5	0.38	0	5,5,5	0.32	0
7	GOL	B	503	-	5,5,5	0.39	0	5,5,5	0.22	0
7	GOL	C	604	-	5,5,5	0.37	0	5,5,5	0.26	0
7	GOL	D	503	-	5,5,5	0.36	0	5,5,5	0.25	0
7	GOL	B	506	-	5,5,5	0.37	0	5,5,5	0.30	0
7	GOL	B	504	-	5,5,5	0.35	0	5,5,5	0.27	0
7	GOL	D	501	-	5,5,5	0.37	0	5,5,5	0.25	0
7	GOL	B	505	-	5,5,5	0.40	0	5,5,5	0.14	0
6	D4T	A	603	5	22,29,29	1.24	3 (13%)	27,45,45	1.66	4 (14%)
7	GOL	B	502	-	5,5,5	0.34	0	5,5,5	0.39	0
7	GOL	A	604	-	5,5,5	0.36	0	5,5,5	0.31	0

In the following table, the Chirals column lists the number of chiral outliers, the number of chiral centers analysed, the number of these observed in the model and the number defined in the Chemical Component Dictionary. Similar counts are reported in the Torsion and Rings columns. '2' means no outliers of that kind were identified.

Mol	Type	Chain	Res	Link	Chirals	Torsions	Rings
7	GOL	B	501	-	-	2/4/4/4	-
7	GOL	C	605	-	-	2/4/4/4	-
6	D4T	C	603	5	-	5/19/31/31	0/2/2/2
7	GOL	D	502	-	-	2/4/4/4	-
7	GOL	B	503	-	-	2/4/4/4	-
7	GOL	C	604	-	-	2/4/4/4	-
7	GOL	D	503	-	-	2/4/4/4	-
7	GOL	B	506	-	-	2/4/4/4	-
7	GOL	B	504	-	-	2/4/4/4	-
7	GOL	D	501	-	-	2/4/4/4	-
7	GOL	B	505	-	-	2/4/4/4	-
6	D4T	A	603	5	-	4/19/31/31	0/2/2/2
7	GOL	B	502	-	-	2/4/4/4	-
7	GOL	A	604	-	-	2/4/4/4	-

The worst 5 of 6 bond length outliers are listed below:

Mol	Chain	Res	Type	Atoms	Z	Observed(Å)	Ideal(Å)
6	A	603	D4T	C5A-C5	2.89	1.56	1.51
6	C	603	D4T	C5A-C5	2.88	1.56	1.51
6	C	603	D4T	C5-C4	-2.86	1.35	1.41
6	A	603	D4T	C5-C4	-2.80	1.35	1.41
6	A	603	D4T	C5'-C4'	-2.16	1.48	1.51

The worst 5 of 8 bond angle outliers are listed below:

Mol	Chain	Res	Type	Atoms	Z	Observed(°)	Ideal(°)
6	C	603	D4T	C2-N3-C4	6.03	120.23	115.14
6	A	603	D4T	C2-N3-C4	5.77	120.01	115.14
6	A	603	D4T	C5'-C4'-C3'	-3.46	109.28	115.61
6	C	603	D4T	C5'-C4'-C3'	-3.28	109.61	115.61
6	A	603	D4T	PB-O7'-PC	-2.75	123.39	132.83

There are no chirality outliers.

5 of 33 torsion outliers are listed below:

Mol	Chain	Res	Type	Atoms
6	A	603	D4T	C5'-O5'-PA-O1A
6	A	603	D4T	C5'-O5'-PA-O2A
6	C	603	D4T	C5'-O5'-PA-O1A
7	A	604	GOL	O1-C1-C2-C3
7	B	501	GOL	O1-C1-C2-C3

There are no ring outliers.

6 monomers are involved in 9 short contacts:

Mol	Chain	Res	Type	Clashes	Symm-Clashes
7	B	501	GOL	1	0
7	D	503	GOL	1	0
7	B	506	GOL	1	0
7	B	504	GOL	3	0
7	B	505	GOL	2	0
7	A	604	GOL	1	0

The following is a two-dimensional graphical depiction of Mogul quality analysis of bond lengths, bond angles, torsion angles, and ring geometry for all instances of the Ligand of Interest. In addition, ligands with molecular weight > 250 and outliers as shown on the validation Tables will also be included. For torsion angles, if less than 5% of the Mogul distribution of torsion angles is within 10 degrees of the torsion angle in question, then that torsion angle is considered an outlier. Any bond that is central to one or more torsion angles identified as an outlier by Mogul will be

highlighted in the graph. For rings, the root-mean-square deviation (RMSD) between the ring in question and similar rings identified by Mogul is calculated over all ring torsion angles. If the average RMSD is greater than 60 degrees and the minimal RMSD between the ring in question and any Mogul-identified rings is also greater than 60 degrees, then that ring is considered an outlier. The outliers are highlighted in purple. The color gray indicates Mogul did not find sufficient equivalents in the CSD to analyse the geometry.

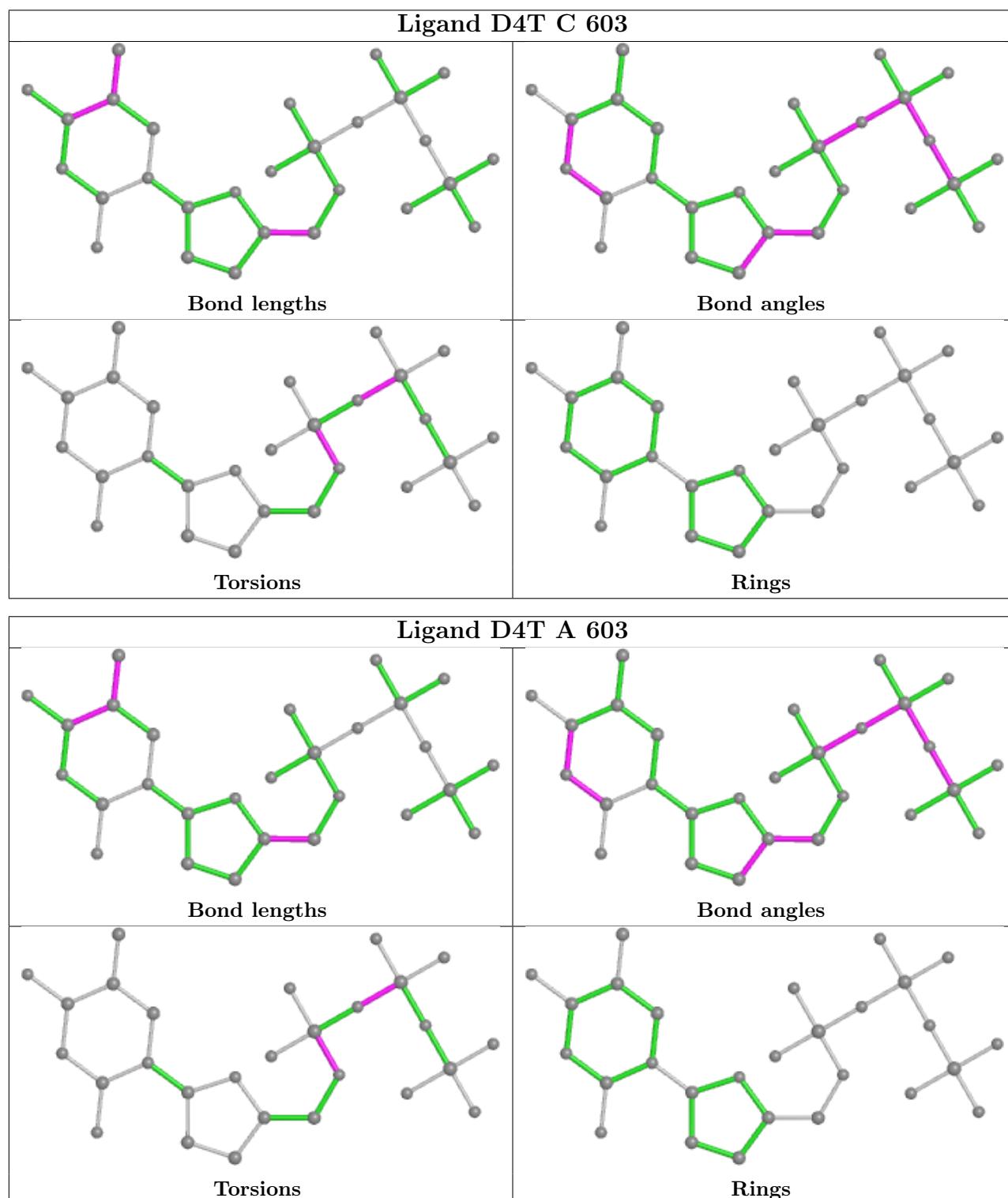

## 5.7 Other polymers [i](#)

There are no such residues in this entry.

## 5.8 Polymer linkage issues [i](#)

There are no chain breaks in this entry.

## 6 Fit of model and data [i](#)

### 6.1 Protein, DNA and RNA chains [i](#)

In the following table, the column labelled ‘#RSRZ > 2’ contains the number (and percentage) of RSRZ outliers, followed by percent RSRZ outliers for the chain as percentile scores relative to all X-ray entries and entries of similar resolution. The OWAB column contains the minimum, median, 95<sup>th</sup> percentile and maximum values of the occupancy-weighted average B-factor per residue. The column labelled ‘Q < 0.9’ lists the number of (and percentage) of residues with an average occupancy less than 0.9.

Mol	Chain	Analysed	<RSRZ>	#RSRZ > 2	OWAB(Å <sup>2</sup> )	Q < 0.9
1	A	555/556 (99%)	0.83	86 (15%) 2 1	34, 86, 199, 280	0
1	C	555/556 (99%)	0.86	105 (18%) 1 1	36, 94, 194, 274	0
2	B	412/444 (92%)	0.33	25 (6%) 21 22	37, 69, 129, 175	0
2	D	402/444 (90%)	0.58	48 (11%) 4 4	37, 84, 150, 209	0
3	E	22/27 (81%)	1.05	5 (22%) 0 0	84, 130, 184, 220	0
3	T	22/27 (81%)	0.86	3 (13%) 3 2	77, 119, 191, 249	0
4	F	19/21 (90%)	0.90	5 (26%) 0 0	70, 111, 222, 225	0
4	P	19/21 (90%)	0.65	3 (15%) 2 1	78, 106, 182, 230	0
All	All	2006/2096 (95%)	0.69	280 (13%) 2 2	34, 84, 181, 280	0

The worst 5 of 280 RSRZ outliers are listed below:

Mol	Chain	Res	Type	RSRZ
1	A	134	SER	13.1
1	A	61	PHE	12.5
1	A	26	LEU	11.2
2	D	4	PRO	10.9
2	D	90	VAL	10.8

### 6.2 Non-standard residues in protein, DNA, RNA chains [i](#)

In the following table, the Atoms column lists the number of modelled atoms in the group and the number defined in the chemical component dictionary. The B-factors column lists the minimum, median, 95<sup>th</sup> percentile and maximum values of B factors of atoms in the group. The column labelled ‘Q < 0.9’ lists the number of atoms with occupancy less than 0.9.

Mol	Type	Chain	Res	Atoms	RSCC	RSR	B-factors(Å <sup>2</sup> )	Q < 0.9
4	DDG	P	822	21/22	0.94	0.14	69,81,95,101	0

*Continued on next page...*

Continued from previous page...

Mol	Type	Chain	Res	Atoms	RSCC	RSR	B-factors( $\text{\AA}^2$ )	Q<0.9
4	DDG	F	822	21/22	0.94	0.17	65,78,90,93	0

### 6.3 Carbohydrates [i](#)

There are no monosaccharides in this entry.

### 6.4 Ligands [i](#)

In the following table, the Atoms column lists the number of modelled atoms in the group and the number defined in the chemical component dictionary. The B-factors column lists the minimum, median, 95<sup>th</sup> percentile and maximum values of B factors of atoms in the group. The column labelled 'Q< 0.9' lists the number of atoms with occupancy less than 0.9.

Mol	Type	Chain	Res	Atoms	RSCC	RSR	B-factors( $\text{\AA}^2$ )	Q<0.9
7	GOL	D	503	6/6	0.62	0.46	104,109,118,118	0
7	GOL	C	604	6/6	0.75	0.35	74,86,93,94	0
7	GOL	C	605	6/6	0.81	0.27	85,97,100,103	0
7	GOL	B	503	6/6	0.85	0.24	67,81,86,87	0
7	GOL	D	501	6/6	0.86	0.20	76,85,91,91	0
7	GOL	B	506	6/6	0.86	0.31	87,102,107,108	0
7	GOL	B	505	6/6	0.91	0.30	19,47,70,73	0
5	MG	C	602	1/1	0.91	0.15	49,49,49,49	0
5	MG	C	601	1/1	0.92	0.04	68,68,68,68	0
7	GOL	B	504	6/6	0.92	0.23	77,86,91,93	0
6	D4T	A	603	28/28	0.93	0.12	85,106,139,142	0
7	GOL	D	502	6/6	0.93	0.24	72,78,94,103	0
7	GOL	B	502	6/6	0.93	0.17	67,80,84,88	0
7	GOL	B	501	6/6	0.94	0.17	60,84,90,97	0
7	GOL	A	604	6/6	0.95	0.23	71,83,92,98	0
6	D4T	C	603	28/28	0.95	0.10	69,103,127,131	0
5	MG	A	602	1/1	0.96	0.14	57,57,57,57	0
5	MG	A	601	1/1	0.99	0.02	86,86,86,86	0

The following is a graphical depiction of the model fit to experimental electron density of all instances of the Ligand of Interest. In addition, ligands with molecular weight > 250 and outliers as shown on the geometry validation Tables will also be included. Each fit is shown from different orientation to approximate a three-dimensional view.



**Electron density around D4T A 603:**

$2mF_o-DF_c$  (at 0.7 rmsd) in gray  
 $mF_o-DF_c$  (at 3 rmsd) in purple (negative)  
and green (positive)

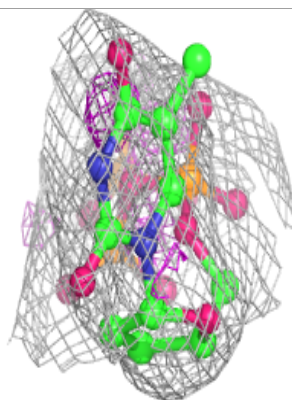
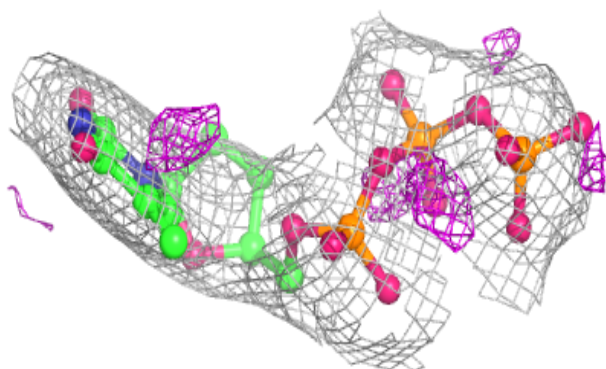
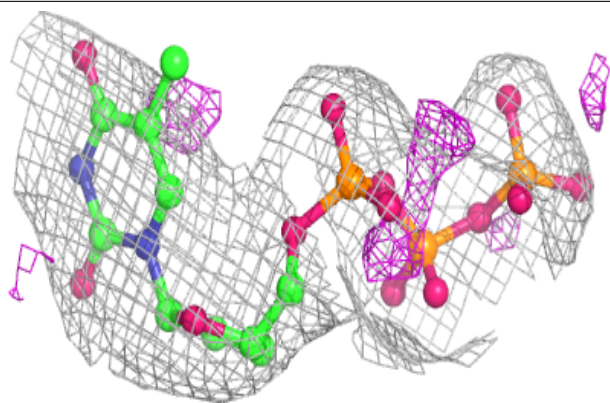
**Electron density around D4T C 603:**

$2mF_o-DF_c$  (at 0.7 rmsd) in gray  
 $mF_o-DF_c$  (at 3 rmsd) in purple (negative)  
and green (positive)

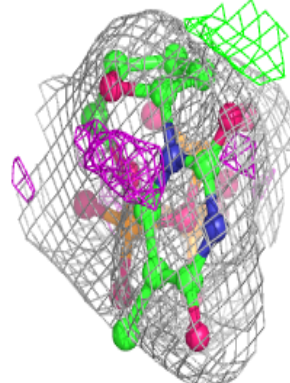
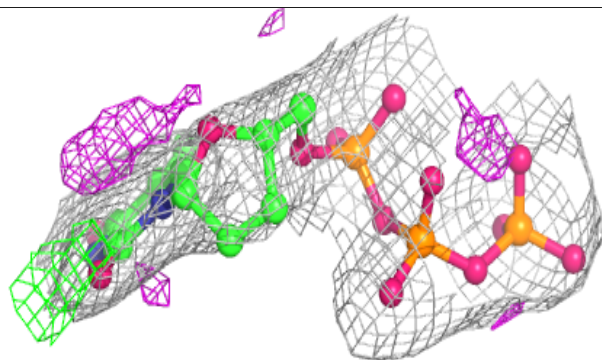
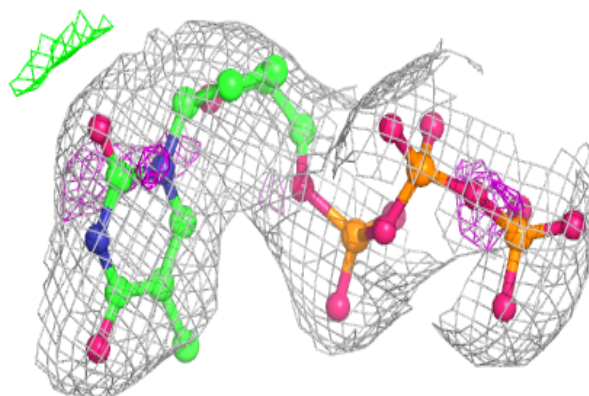

## 6.5 Other polymers [i](#)

There are no such residues in this entry.