



# Full wwPDB X-ray Structure Validation Report ⓘ

May 14, 2020 – 03:06 am BST

PDB ID : 4LXM  
Title : Crystal Structure of Human Beta Secretase in Complex with compound 12a  
Authors : Rondeau, J.M.; Bourcier, E.  
Deposited on : 2013-07-30  
Resolution : 2.30 Å(reported)

This is a Full wwPDB X-ray Structure Validation Report for a publicly released PDB entry.

We welcome your comments at [validation@mail.wwpdb.org](mailto:validation@mail.wwpdb.org)

A user guide is available at

<https://www.wwpdb.org/validation/2017/XrayValidationReportHelp>

with specific help available everywhere you see the ⓘ symbol.

---

The following versions of software and data (see [references ⓘ](#)) were used in the production of this report:

MolProbity : 4.02b-467  
Mogul : 1.8.5 (274361), CSD as541be (2020)  
Xtriage (Phenix) : 1.13  
EDS : 2.11  
buster-report : 1.1.7 (2018)  
Percentile statistics : 20191225.v01 (using entries in the PDB archive December 25th 2019)  
Refmac : 5.8.0158  
CCP4 : 7.0.044 (Gargrove)  
Ideal geometry (proteins) : Engh & Huber (2001)  
Ideal geometry (DNA, RNA) : Parkinson et al. (1996)  
Validation Pipeline (wwPDB-VP) : 2.11

# 1 Overall quality at a glance

The following experimental techniques were used to determine the structure:

*X-RAY DIFFRACTION*

The reported resolution of this entry is 2.30 Å.

Percentile scores (ranging between 0-100) for global validation metrics of the entry are shown in the following graphic. The table shows the number of entries on which the scores are based.

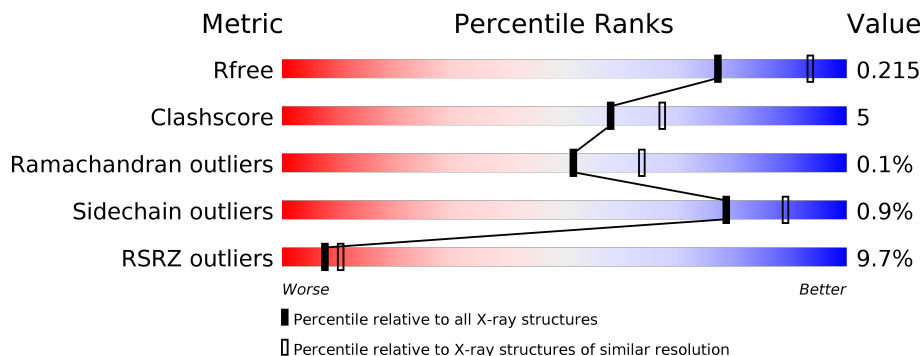

Metric	Whole archive (#Entries)	Similar resolution (#Entries, resolution range(Å))
$R_{free}$	130704	5042 (2.30-2.30)
Clashscore	141614	5643 (2.30-2.30)
Ramachandran outliers	138981	5575 (2.30-2.30)
Sidechain outliers	138945	5575 (2.30-2.30)
RSRZ outliers	127900	4938 (2.30-2.30)

The table below summarises the geometric issues observed across the polymeric chains and their fit to the electron density. The red, orange, yellow and green segments on the lower bar indicate the fraction of residues that contain outliers for  $\geq 3$ , 2, 1 and 0 types of geometric quality criteria respectively. A grey segment represents the fraction of residues that are not modelled. The numeric value for each fraction is indicated below the corresponding segment, with a dot representing fractions  $\leq 5\%$ . The upper red bar (where present) indicates the fraction of residues that have poor fit to the electron density. The numeric value is given above the bar.

Mol	Chain	Length	Quality of chain
1	A	402	 8% 85% 9% 6%
1	B	402	 10% 84% 9% 6%
1	C	402	 10% 83% 11% 5%

## 2 Entry composition

There are 3 unique types of molecules in this entry. The entry contains 9581 atoms, of which 0 are hydrogens and 0 are deuteriums.

In the tables below, the ZeroOcc column contains the number of atoms modelled with zero occupancy, the AltConf column contains the number of residues with at least one atom in alternate conformation and the Trace column contains the number of residues modelled with at most 2 atoms.

- Molecule 1 is a protein called Beta-secretase 1.

Mol	Chain	Residues	Atoms					ZeroOcc	AltConf	Trace
			Total	C	N	O	S			
1	A	377	2966	1898	493	561	14	0	0	0
1	B	377	2966	1898	493	561	14	0	0	0
1	C	381	3001	1922	500	565	14	0	1	0

There are 6 discrepancies between the modelled and reference sequences:

Chain	Residue	Modelled	Actual	Comment	Reference
A	33P	GLY	-	EXPRESSION TAG	UNP P56817
A	34P	PRO	-	EXPRESSION TAG	UNP P56817
B	33P	GLY	-	EXPRESSION TAG	UNP P56817
B	34P	PRO	-	EXPRESSION TAG	UNP P56817
C	33P	GLY	-	EXPRESSION TAG	UNP P56817
C	34P	PRO	-	EXPRESSION TAG	UNP P56817

- Molecule 2 is (1S,3S,4S,5R)-3-{4-amino-3-fluoro-5-[(1,1,1,3,3,3-hexafluoropropan-2-yl)oxy]benzyl}-5-[(3-tert-butylbenzyl)amino]tetrahydro-2H-thiopyran-4-ol 1-oxide (three-letter code: 1YU) (formula: C<sub>26</sub>H<sub>31</sub>F<sub>7</sub>N<sub>2</sub>O<sub>3</sub>S).



### 3 Residue-property plots [i](#)

These plots are drawn for all protein, RNA and DNA chains in the entry. The first graphic for a chain summarises the proportions of the various outlier classes displayed in the second graphic. The second graphic shows the sequence view annotated by issues in geometry and electron density. Residues are color-coded according to the number of geometric quality criteria for which they contain at least one outlier: green = 0, yellow = 1, orange = 2 and red = 3 or more. A red dot above a residue indicates a poor fit to the electron density ( $RSRZ > 2$ ). Stretches of 2 or more consecutive residues without any outlier are shown as a green connector. Residues present in the sample, but not in the model, are shown in grey.

- Molecule 1: Beta-secretase 1

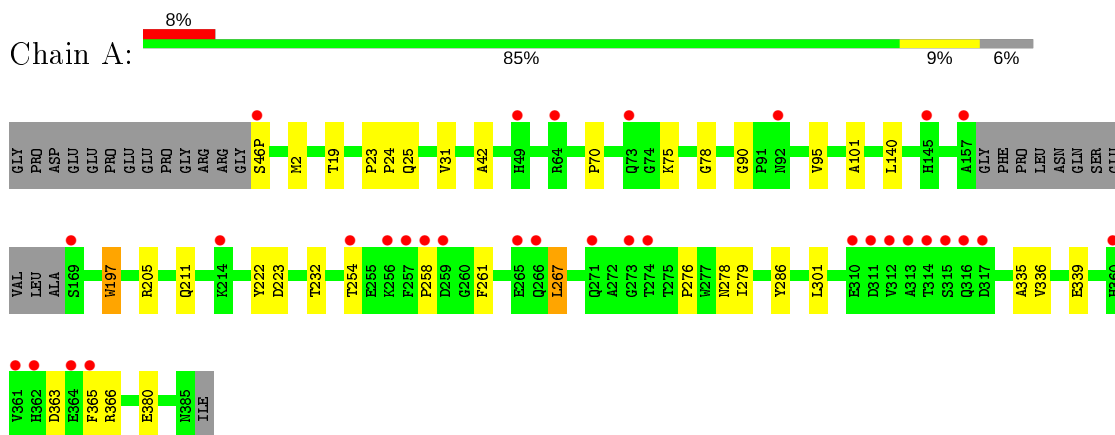

- Molecule 1: Beta-secretase 1

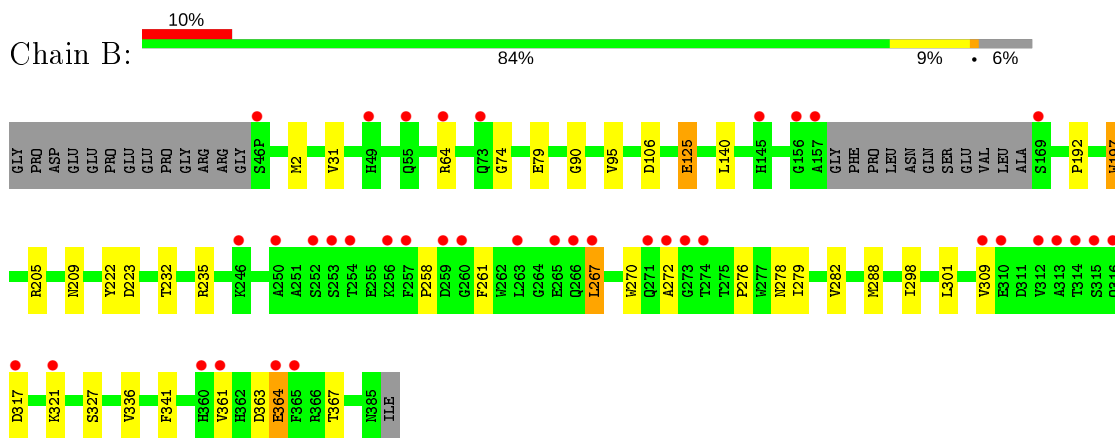

- Molecule 1: Beta-secretase 1

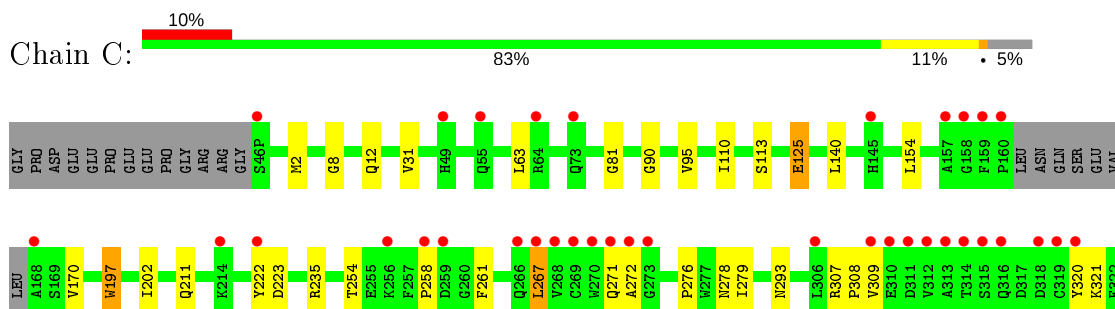

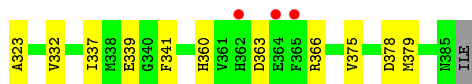

## 4 Data and refinement statistics

Property	Value	Source
Space group	P 1 21 1	Depositor
Cell constants a, b, c, $\alpha$ , $\beta$ , $\gamma$	82.29Å 104.45Å 100.49Å 90.00° 104.30° 90.00°	Depositor
Resolution (Å)	16.67 – 2.30 16.67 – 2.30	Depositor EDS
% Data completeness (in resolution range)	99.7 (16.67-2.30) 99.8 (16.67-2.30)	Depositor EDS
$R_{merge}$	0.09	Depositor
$R_{sym}$	(Not available)	Depositor
$\langle I/\sigma(I) \rangle$ <sup>1</sup>	4.69 (at 2.30Å)	Xtriage
Refinement program	CNS, CNX 2002	Depositor
R, $R_{free}$	0.194 , 0.218 0.189 , 0.215	Depositor DCC
$R_{free}$ test set	3719 reflections (5.11%)	wwPDB-VP
Wilson B-factor (Å <sup>2</sup> )	41.5	Xtriage
Anisotropy	0.435	Xtriage
Bulk solvent $k_{sol}$ (e/Å <sup>3</sup> ), $B_{sol}$ (Å <sup>2</sup> )	0.36 , 50.1	EDS
L-test for twinning <sup>2</sup>	$\langle  L  \rangle = 0.49$ , $\langle L^2 \rangle = 0.33$	Xtriage
Estimated twinning fraction	No twinning to report.	Xtriage
$F_o, F_c$ correlation	0.96	EDS
Total number of atoms	9581	wwPDB-VP
Average B, all atoms (Å <sup>2</sup> )	47.0	wwPDB-VP

Xtriage's analysis on translational NCS is as follows: *The largest off-origin peak in the Patterson function is 4.03% of the height of the origin peak. No significant pseudotranslation is detected.*

<sup>1</sup> Intensities estimated from amplitudes.

<sup>2</sup> Theoretical values of  $\langle |L| \rangle$ ,  $\langle L^2 \rangle$  for acentric reflections are 0.5, 0.333 respectively for untwinned datasets, and 0.375, 0.2 for perfectly twinned datasets.

## 5 Model quality [i](#)

### 5.1 Standard geometry [i](#)

Bond lengths and bond angles in the following residue types are not validated in this section: 1YU

The Z score for a bond length (or angle) is the number of standard deviations the observed value is removed from the expected value. A bond length (or angle) with  $|Z| > 5$  is considered an outlier worth inspection. RMSZ is the root-mean-square of all Z scores of the bond lengths (or angles).

Mol	Chain	Bond lengths		Bond angles	
		RMSZ	# Z  >5	RMSZ	# Z  >5
1	A	0.31	0/3041	0.47	0/4133
1	B	0.31	0/3041	0.47	0/4133
1	C	0.31	0/3081	0.47	0/4188
All	All	0.31	0/9163	0.47	0/12454

There are no bond length outliers.

There are no bond angle outliers.

There are no chirality outliers.

There are no planarity outliers.

### 5.2 Too-close contacts [i](#)

In the following table, the Non-H and H(model) columns list the number of non-hydrogen atoms and hydrogen atoms in the chain respectively. The H(added) column lists the number of hydrogen atoms added and optimized by MolProbity. The Clashes column lists the number of clashes within the asymmetric unit, whereas Symm-Clashes lists symmetry related clashes.

Mol	Chain	Non-H	H(model)	H(added)	Clashes	Symm-Clashes
1	A	2966	0	2875	23	0
1	B	2966	0	2875	30	0
1	C	3001	0	2912	34	0
2	A	39	0	31	0	0
2	B	39	0	31	0	0
2	C	39	0	31	0	0
3	A	185	0	0	3	0
3	B	160	0	0	4	0
3	C	186	0	0	3	0
All	All	9581	0	8755	86	0



The all-atom clashscore is defined as the number of clashes found per 1000 atoms (including hydrogen atoms). The all-atom clashscore for this structure is 5.

All (86) close contacts within the same asymmetric unit are listed below, sorted by their clash magnitude.

Atom-1	Atom-2	Interatomic distance (Å)	Clash overlap (Å)
1:B:267:LEU:HD23	1:B:267:LEU:H	1.45	0.81
1:C:267:LEU:H	1:C:267:LEU:HD23	1.46	0.80
1:A:267:LEU:HD23	1:A:267:LEU:H	1.44	0.79
1:B:192:PRO:HG2	1:B:288:MET:CE	2.22	0.69
1:C:309:VAL:HG11	1:C:321:LYS:HG3	1.74	0.68
1:C:12:GLN:OE1	1:C:113:SER:HA	1.95	0.67
1:B:232:THR:O	1:B:336:VAL:HG13	1.98	0.63
1:B:192:PRO:HG2	1:B:288:MET:HE3	1.81	0.62
1:C:258:PRO:O	1:C:261:PHE:HB3	2.03	0.59
1:C:125:GLU:HG2	1:C:197:TRP:HB3	1.86	0.58
1:B:209:ASN:HA	3:B:705:HOH:O	2.03	0.57
1:A:258:PRO:O	1:A:261:PHE:HB3	2.05	0.57
1:B:258:PRO:O	1:B:261:PHE:HB3	2.05	0.57
1:B:276:PRO:O	1:B:279:ILE:HG12	2.04	0.56
1:B:192:PRO:HG2	1:B:288:MET:HE2	1.87	0.56
1:A:2:MET:HG2	1:A:90:GLY:HA2	1.88	0.56
1:B:2:MET:HG2	1:B:90:GLY:HA2	1.88	0.56
1:A:254:THR:HG21	1:C:254:THR:HG21	1.88	0.55
1:A:232:THR:O	1:A:336:VAL:HG13	2.06	0.55
1:C:202:ILE:CD1	1:C:379:MET:HG3	2.38	0.54
1:C:276:PRO:O	1:C:279:ILE:HG12	2.08	0.54
1:A:276:PRO:O	1:A:279:ILE:HG12	2.08	0.53
1:B:270:TRP:O	1:B:317:ASP:HB3	2.08	0.52
1:C:211:GLN:HB2	3:C:783:HOH:O	2.09	0.52
1:C:363:ASP:HB3	1:C:366:ARG:O	2.10	0.52
1:B:267:LEU:HD13	1:B:309:VAL:HG21	1.92	0.51
1:C:2:MET:HG2	1:C:90:GLY:HA2	1.93	0.50
1:A:363:ASP:HB3	1:A:366:ARG:O	2.11	0.50
1:B:309:VAL:HG11	1:B:321:LYS:HG3	1.93	0.50
1:C:307[B]:ARG:HG3	1:C:323:ALA:HB2	1.94	0.49
1:A:365:PHE:HB2	3:A:782:HOH:O	2.13	0.48
1:C:293:ASN:HA	1:C:375:VAL:HA	1.95	0.48
1:C:267:LEU:HD13	1:C:309:VAL:CG2	2.42	0.48
1:C:95:VAL:HG11	1:C:140:LEU:HA	1.95	0.48
1:B:125:GLU:O	1:B:125:GLU:HG3	2.14	0.47
1:A:46(P):SER:N	3:A:767:HOH:O	2.47	0.47
1:B:95:VAL:HG11	1:B:140:LEU:HA	1.96	0.47

*Continued on next page...*

*Continued from previous page...*

Atom-1	Atom-2	Interatomic distance (Å)	Clash overlap (Å)
1:A:95:VAL:HG11	1:A:140:LEU:HA	1.96	0.47
1:B:125:GLU:HG2	1:B:197:TRP:HB3	1.97	0.46
1:B:301:LEU:HD11	1:B:367:THR:HA	1.98	0.46
1:A:278:ASN:H	1:A:278:ASN:ND2	2.15	0.45
1:C:378:ASP:HB2	3:C:681:HOH:O	2.16	0.45
1:C:278:ASN:ND2	1:C:278:ASN:H	2.14	0.45
1:A:380:GLU:HG2	3:A:738:HOH:O	2.15	0.45
1:C:8:GLY:O	1:C:170:VAL:HG22	2.17	0.45
1:C:154:LEU:O	1:C:339:GLU:HA	2.17	0.45
1:B:278:ASN:H	1:B:278:ASN:ND2	2.15	0.44
1:B:205:ARG:NH1	3:B:758:HOH:O	2.49	0.44
1:B:31:VAL:O	1:B:31:VAL:HG23	2.17	0.44
1:C:337:ILE:O	1:C:341:PHE:HD1	2.00	0.44
1:A:42:ALA:CB	1:A:101:ALA:HB1	2.47	0.44
1:B:222:TYR:HA	1:B:223:ASP:HA	1.62	0.44
1:A:335:ALA:O	1:A:339:GLU:HG3	2.18	0.44
1:C:31:VAL:HG23	1:C:31:VAL:O	2.18	0.43
1:A:222:TYR:HA	1:A:223:ASP:HA	1.61	0.43
1:C:360:HIS:HB2	3:C:768:HOH:O	2.18	0.43
1:A:70:PRO:HA	1:A:75:LYS:HB3	2.01	0.43
1:C:222:TYR:HA	1:C:223:ASP:HA	1.62	0.43
1:C:125:GLU:HG2	1:C:197:TRP:CB	2.49	0.43
1:A:78:GLY:HA3	1:A:101:ALA:O	2.19	0.42
1:A:19:THR:HA	1:A:25:GLN:O	2.20	0.42
1:A:301:LEU:HD13	1:A:363:ASP:HB2	2.00	0.42
1:C:278:ASN:H	1:C:278:ASN:HD22	1.67	0.42
1:B:235:ARG:HB3	1:B:327:SER:HB2	2.02	0.42
1:B:282:VAL:HG22	3:B:705:HOH:O	2.19	0.42
1:C:307[B]:ARG:HA	1:C:308:PRO:HD3	1.92	0.42
1:C:63:LEU:HG	1:C:81:GLY:HA2	2.01	0.42
1:B:74:GLY:HA2	1:B:106:ASP:O	2.20	0.41
1:C:110:ILE:HB	1:C:113:SER:HB3	2.03	0.41
1:C:267:LEU:N	1:C:267:LEU:HD23	2.25	0.41
1:B:363:ASP:O	1:B:364:GLU:HB3	2.20	0.41
1:A:205:ARG:HB3	1:A:286:TYR:HB2	2.03	0.41
1:B:298:ILE:HB	1:B:341:PHE:CZ	2.55	0.41
1:B:361:VAL:HA	3:B:756:HOH:O	2.20	0.41
1:C:125:GLU:HG3	1:C:125:GLU:O	2.17	0.41
1:C:271:GLN:O	1:C:272:ALA:C	2.59	0.41
1:A:31:VAL:HG23	1:A:31:VAL:O	2.20	0.41
1:B:64:ARG:HA	1:B:79:GLU:OE2	2.21	0.41

*Continued on next page...*

Continued from previous page...

Atom-1	Atom-2	Interatomic distance (Å)	Clash overlap (Å)
1:A:197:TRP:N	1:A:197:TRP:CD1	2.89	0.41
1:B:272:ALA:HB2	1:B:317:ASP:HA	2.02	0.40
1:B:363:ASP:OD1	1:B:364:GLU:N	2.48	0.40
1:A:23:PRO:HA	1:A:24:PRO:HD3	1.94	0.40
1:C:267:LEU:HD13	1:C:309:VAL:HG23	2.03	0.40
1:B:278:ASN:H	1:B:278:ASN:HD22	1.69	0.40
1:C:235:ARG:HB2	1:C:332:VAL:HB	2.03	0.40

There are no symmetry-related clashes.

## 5.3 Torsion angles [i](#)

### 5.3.1 Protein backbone [i](#)

In the following table, the Percentiles column shows the percent Ramachandran outliers of the chain as a percentile score with respect to all X-ray entries followed by that with respect to entries of similar resolution.

The Analysed column shows the number of residues for which the backbone conformation was analysed, and the total number of residues.

Mol	Chain	Analysed	Favoured	Allowed	Outliers	Percentiles	
1	A	373/402 (93%)	364 (98%)	9 (2%)	0	100	100
1	B	373/402 (93%)	361 (97%)	11 (3%)	1 (0%)	41	50
1	C	378/402 (94%)	369 (98%)	9 (2%)	0	100	100
All	All	1124/1206 (93%)	1094 (97%)	29 (3%)	1 (0%)	51	64

All (1) Ramachandran outliers are listed below:

Mol	Chain	Res	Type
1	B	364	GLU

### 5.3.2 Protein sidechains [i](#)

In the following table, the Percentiles column shows the percent sidechain outliers of the chain as a percentile score with respect to all X-ray entries followed by that with respect to entries of similar resolution.

The Analysed column shows the number of residues for which the sidechain conformation was analysed, and the total number of residues.

Mol	Chain	Analysed	Rotameric	Outliers	Percentiles	
1	A	322/342 (94%)	319 (99%)	3 (1%)	78	89
1	B	322/342 (94%)	319 (99%)	3 (1%)	78	89
1	C	325/342 (95%)	322 (99%)	3 (1%)	78	89
All	All	969/1026 (94%)	960 (99%)	9 (1%)	78	89

All (9) residues with a non-rotameric sidechain are listed below:

Mol	Chain	Res	Type
1	A	197	TRP
1	A	211	GLN
1	A	267	LEU
1	B	125	GLU
1	B	197	TRP
1	B	267	LEU
1	C	125	GLU
1	C	197	TRP
1	C	267	LEU

Some sidechains can be flipped to improve hydrogen bonding and reduce clashes. All (10) such sidechains are listed below:

Mol	Chain	Res	Type
1	A	114	ASN
1	A	278	ASN
1	A	326	GLN
1	B	114	ASN
1	B	278	ASN
1	B	293	ASN
1	C	92	ASN
1	C	114	ASN
1	C	278	ASN
1	C	326	GLN

### 5.3.3 RNA [i](#)

There are no RNA molecules in this entry.

## 5.4 Non-standard residues in protein, DNA, RNA chains [i](#)

There are no non-standard protein/DNA/RNA residues in this entry.

## 5.5 Carbohydrates [i](#)

There are no carbohydrates in this entry.

## 5.6 Ligand geometry [i](#)

3 ligands are modelled in this entry.

In the following table, the Counts columns list the number of bonds (or angles) for which Mogul statistics could be retrieved, the number of bonds (or angles) that are observed in the model and the number of bonds (or angles) that are defined in the Chemical Component Dictionary. The Link column lists molecule types, if any, to which the group is linked. The Z score for a bond length (or angle) is the number of standard deviations the observed value is removed from the expected value. A bond length (or angle) with  $|Z| > 2$  is considered an outlier worth inspection. RMSZ is the root-mean-square of all Z scores of the bond lengths (or angles).

Mol	Type	Chain	Res	Link	Bond lengths			Bond angles		
					Counts	RMSZ	# Z  > 2	Counts	RMSZ	# Z  > 2
2	1YU	C	501	-	39,41,41	1.75	7 (17%)	54,63,63	1.21	5 (9%)
2	1YU	A	501	-	39,41,41	1.75	7 (17%)	54,63,63	1.21	4 (7%)
2	1YU	B	501	-	39,41,41	1.76	7 (17%)	54,63,63	1.23	3 (5%)

In the following table, the Chirals column lists the number of chiral outliers, the number of chiral centers analysed, the number of these observed in the model and the number defined in the Chemical Component Dictionary. Similar counts are reported in the Torsion and Rings columns. '-' means no outliers of that kind were identified.

Mol	Type	Chain	Res	Link	Chirals	Torsions	Rings
2	1YU	C	501	-	-	1/31/47/47	0/3/3/3
2	1YU	A	501	-	-	1/31/47/47	0/3/3/3
2	1YU	B	501	-	-	2/31/47/47	0/3/3/3

All (21) bond length outliers are listed below:

Mol	Chain	Res	Type	Atoms	Z	Observed(Å)	Ideal(Å)
2	A	501	1YU	C9-C10	4.46	1.42	1.38
2	B	501	1YU	C9-C10	4.40	1.42	1.38
2	C	501	1YU	C9-C10	4.39	1.42	1.38
2	B	501	1YU	C25-C23	3.94	1.56	1.52
2	C	501	1YU	C25-C23	3.87	1.56	1.52
2	A	501	1YU	C25-C23	3.76	1.56	1.52
2	A	501	1YU	C16-C19	3.05	1.57	1.53
2	C	501	1YU	C16-C19	2.97	1.57	1.53

*Continued on next page...*

Continued from previous page...

Mol	Chain	Res	Type	Atoms	Z	Observed(Å)	Ideal(Å)
2	A	501	1YU	C19-C21	2.97	1.57	1.53
2	B	501	1YU	C19-C21	2.94	1.56	1.53
2	B	501	1YU	C16-C19	2.88	1.57	1.53
2	C	501	1YU	C19-C21	2.79	1.56	1.53
2	A	501	1YU	C11-C10	2.73	1.42	1.37
2	B	501	1YU	C11-C10	2.64	1.42	1.37
2	C	501	1YU	C11-C10	2.62	1.42	1.37
2	C	501	1YU	C42-C41	2.49	1.43	1.39
2	B	501	1YU	C42-C41	2.42	1.43	1.39
2	C	501	1YU	C21-C23	2.26	1.57	1.52
2	A	501	1YU	C42-C41	2.23	1.42	1.39
2	A	501	1YU	C21-C23	2.16	1.57	1.52
2	B	501	1YU	C39-C41	2.08	1.42	1.39

All (12) bond angle outliers are listed below:

Mol	Chain	Res	Type	Atoms	Z	Observed(°)	Ideal(°)
2	B	501	1YU	C8-C9-C10	3.69	119.55	116.01
2	A	501	1YU	C8-C9-C10	3.67	119.53	116.01
2	C	501	1YU	C8-C9-C10	3.48	119.35	116.01
2	B	501	1YU	O7-C8-C9	3.17	118.99	114.84
2	A	501	1YU	C35-N33-C23	3.16	121.54	114.90
2	B	501	1YU	C35-N33-C23	2.98	121.16	114.90
2	C	501	1YU	C35-N33-C23	2.98	121.15	114.90
2	C	501	1YU	O7-C8-C9	2.95	118.71	114.84
2	A	501	1YU	O7-C8-C9	2.74	118.42	114.84
2	C	501	1YU	O61-C21-C23	-2.20	104.92	109.47
2	C	501	1YU	C11-C10-C9	-2.08	120.25	123.24
2	A	501	1YU	C21-C23-N33	2.02	113.35	109.66

There are no chirality outliers.

All (4) torsion outliers are listed below:

Mol	Chain	Res	Type	Atoms
2	B	501	1YU	C9-C8-O7-C5
2	C	501	1YU	C14-C8-O7-C5
2	A	501	1YU	C14-C8-O7-C5
2	B	501	1YU	C14-C8-O7-C5

There are no ring outliers.

No monomer is involved in short contacts.

The following is a two-dimensional graphical depiction of Mogul quality analysis of bond lengths, bond angles, torsion angles, and ring geometry for all instances of the Ligand of Interest. In addition, ligands with molecular weight > 250 and outliers as shown on the validation Tables will also be included. For torsion angles, if less than 5% of the Mogul distribution of torsion angles is within 10 degrees of the torsion angle in question, then that torsion angle is considered an outlier. Any bond that is central to one or more torsion angles identified as an outlier by Mogul will be highlighted in the graph. For rings, the root-mean-square deviation (RMSD) between the ring in question and similar rings identified by Mogul is calculated over all ring torsion angles. If the average RMSD is greater than 60 degrees and the minimal RMSD between the ring in question and any Mogul-identified rings is also greater than 60 degrees, then that ring is considered an outlier. The outliers are highlighted in purple. The color gray indicates Mogul did not find sufficient equivalents in the CSD to analyse the geometry.

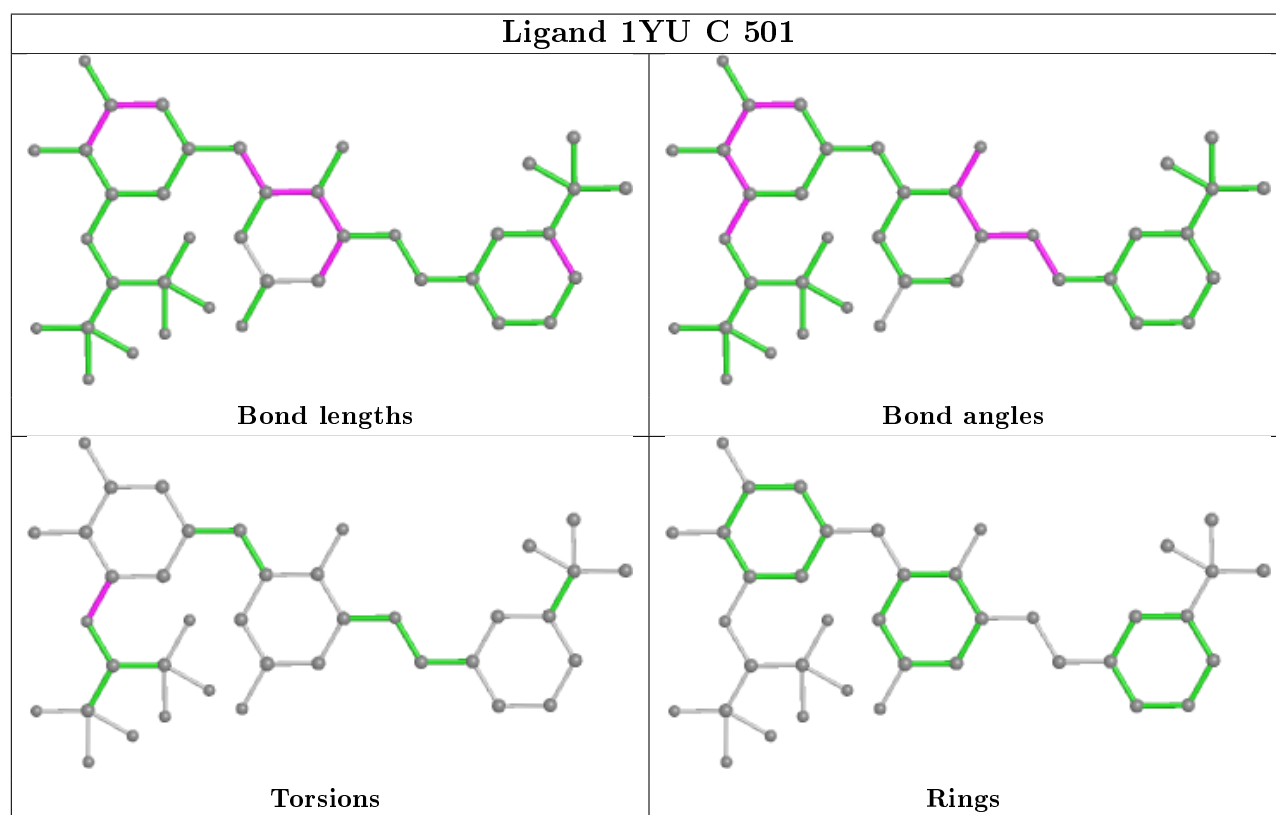

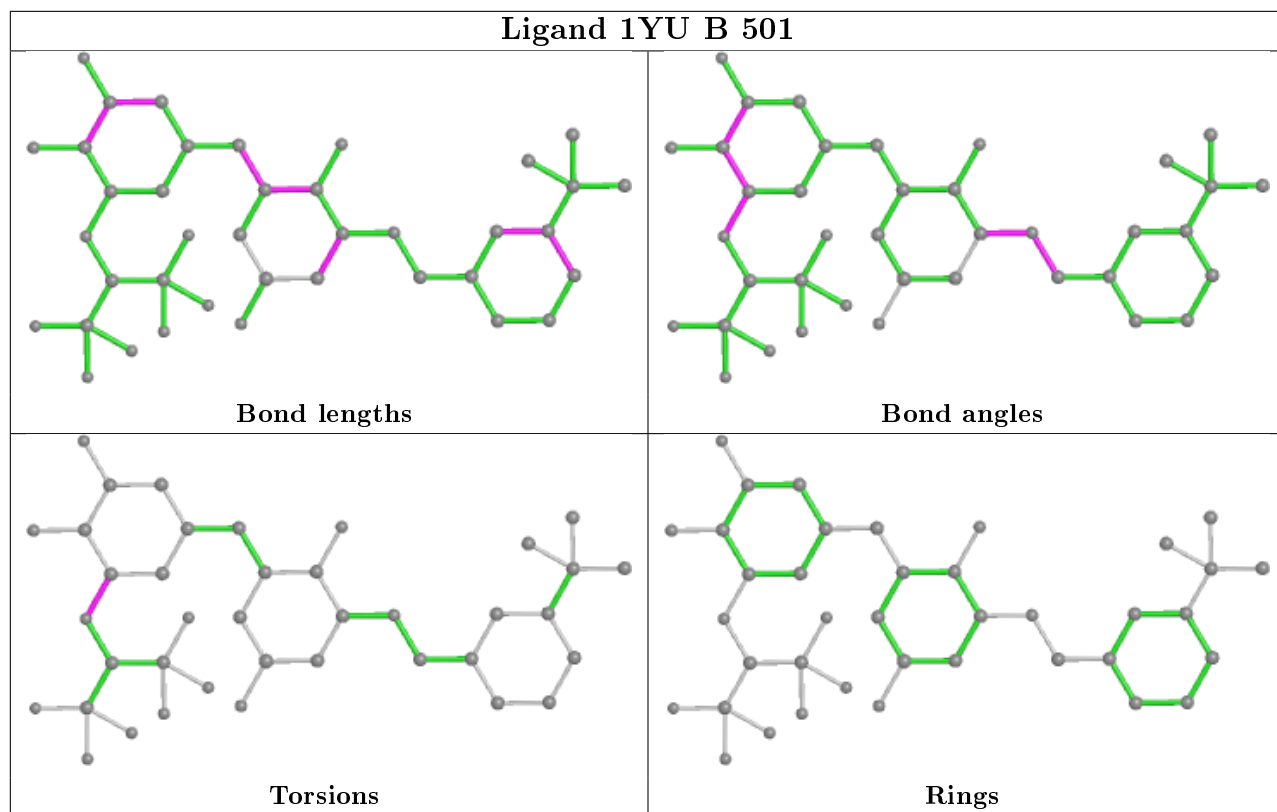
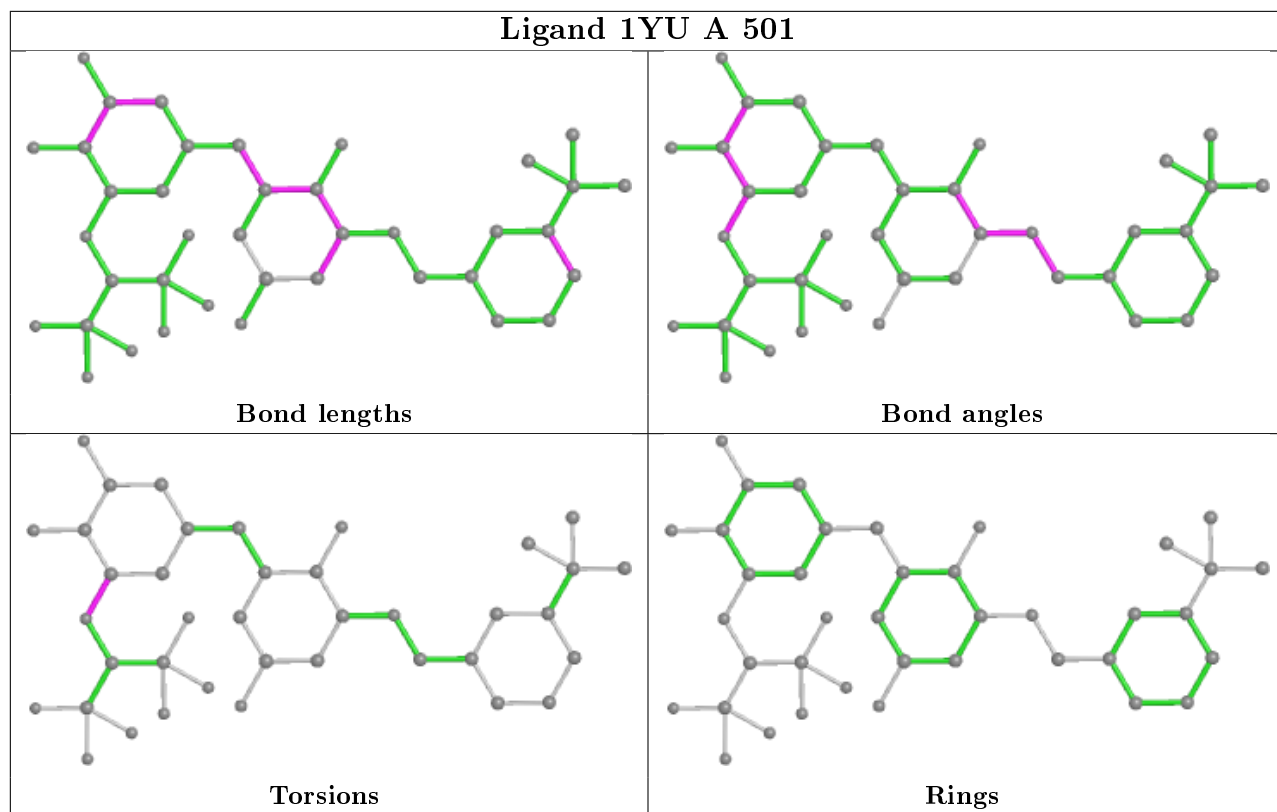



## 5.7 Other polymers [i](#)

There are no such residues in this entry.

## 5.8 Polymer linkage issues [i](#)

There are no chain breaks in this entry.

## 6 Fit of model and data [i](#)

### 6.1 Protein, DNA and RNA chains [i](#)

In the following table, the column labelled ‘#RSRZ> 2’ contains the number (and percentage) of RSRZ outliers, followed by percent RSRZ outliers for the chain as percentile scores relative to all X-ray entries and entries of similar resolution. The OWAB column contains the minimum, median, 95<sup>th</sup> percentile and maximum values of the occupancy-weighted average B-factor per residue. The column labelled ‘Q< 0.9’ lists the number of (and percentage) of residues with an average occupancy less than 0.9.

Mol	Chain	Analysed	<RSRZ>	#RSRZ>2	OWAB(Å <sup>2</sup> )	Q<0.9
1	A	377/402 (93%)	0.24	32 (8%) 10 14	28, 43, 82, 117	0
1	B	377/402 (93%)	0.38	39 (10%) 6 9	26, 44, 86, 119	0
1	C	381/402 (94%)	0.27	39 (10%) 6 9	27, 43, 85, 116	0
All	All	1135/1206 (94%)	0.30	110 (9%) 7 10	26, 44, 85, 119	0

All (110) RSRZ outliers are listed below:

Mol	Chain	Res	Type	RSRZ
1	B	314	THR	11.8
1	A	314	THR	10.9
1	B	361	VAL	10.6
1	B	312	VAL	10.2
1	A	312	VAL	9.4
1	C	312	VAL	9.4
1	A	313	ALA	8.9
1	C	158	GLY	8.7
1	B	315	SER	8.7
1	A	316	GLN	7.4
1	B	313	ALA	7.3
1	C	313	ALA	7.2
1	C	159	PHE	7.1
1	C	314	THR	6.8
1	B	310	GLU	6.3
1	B	256	LYS	6.2
1	C	168	ALA	6.1
1	B	316	GLN	5.6
1	A	315	SER	5.3
1	C	273	GLY	5.2
1	C	272	ALA	5.1
1	A	311	ASP	5.0
1	C	315	SER	5.0

*Continued on next page...*

*Continued from previous page...*

<b>Mol</b>	<b>Chain</b>	<b>Res</b>	<b>Type</b>	<b>RSRZ</b>
1	B	253	SER	5.0
1	C	362	HIS	4.9
1	C	160	PRO	4.9
1	A	256	LYS	4.9
1	C	256	LYS	4.8
1	A	157	ALA	4.8
1	C	316	GLN	4.8
1	C	46(P)	SER	4.7
1	B	274	THR	4.7
1	B	365	PHE	4.5
1	C	311	ASP	4.4
1	B	157	ALA	4.4
1	B	360	HIS	4.2
1	B	49	HIS	4.2
1	B	364	GLU	4.2
1	B	271	GLN	3.9
1	B	254	THR	3.8
1	C	310	GLU	3.7
1	C	268	VAL	3.7
1	C	64	ARG	3.6
1	B	317	ASP	3.6
1	C	364	GLU	3.5
1	B	266	GLN	3.5
1	A	64	ARG	3.5
1	C	258	PRO	3.4
1	C	365	PHE	3.3
1	A	169	SER	3.3
1	B	272	ALA	3.3
1	A	362	HIS	3.2
1	A	361	VAL	3.2
1	C	49	HIS	3.2
1	B	257	PHE	3.2
1	C	267	LEU	3.2
1	A	364	GLU	3.1
1	A	145	HIS	3.1
1	A	73	GLN	3.0
1	A	266	GLN	3.0
1	C	145	HIS	2.9
1	B	46(P)	SER	2.9
1	C	309	VAL	2.9
1	A	310	GLU	2.9
1	A	274	THR	2.8

*Continued on next page...*

*Continued from previous page...*

<b>Mol</b>	<b>Chain</b>	<b>Res</b>	<b>Type</b>	<b>RSRZ</b>
1	B	309	VAL	2.8
1	B	265	GLU	2.8
1	A	271	GLN	2.8
1	A	46(P)	SER	2.7
1	A	254	THR	2.6
1	C	319	CYS	2.6
1	B	246	LYS	2.6
1	C	157	ALA	2.6
1	C	55	GLN	2.6
1	B	263	LEU	2.6
1	C	320	TYR	2.6
1	C	259	ASP	2.5
1	C	214	LYS	2.5
1	C	318	ASP	2.5
1	A	365	PHE	2.5
1	B	250	ALA	2.5
1	B	273	GLY	2.5
1	C	73	GLN	2.5
1	A	259	ASP	2.5
1	B	64	ARG	2.5
1	B	321	LYS	2.5
1	C	270	TRP	2.4
1	A	265	GLU	2.4
1	C	266	GLN	2.4
1	A	273	GLY	2.4
1	B	169	SER	2.3
1	B	252	SER	2.3
1	C	269	CYS	2.3
1	B	260	GLY	2.3
1	A	360	HIS	2.3
1	A	257	PHE	2.3
1	A	92	ASN	2.2
1	B	145	HIS	2.2
1	B	267	LEU	2.1
1	B	156	GLY	2.1
1	C	222	TYR	2.1
1	A	317	ASP	2.1
1	A	49	HIS	2.1
1	B	55	GLN	2.1
1	A	258	PRO	2.1
1	C	306	LEU	2.1
1	C	271	GLN	2.0

*Continued on next page...*

*Continued from previous page...*

Mol	Chain	Res	Type	RSRZ
1	B	259	ASP	2.0
1	B	73	GLN	2.0
1	A	214	LYS	2.0

## 6.2 Non-standard residues in protein, DNA, RNA chains [i](#)

There are no non-standard protein/DNA/RNA residues in this entry.

## 6.3 Carbohydrates [i](#)

There are no carbohydrates in this entry.

## 6.4 Ligands [i](#)

In the following table, the Atoms column lists the number of modelled atoms in the group and the number defined in the chemical component dictionary. The B-factors column lists the minimum, median, 95<sup>th</sup> percentile and maximum values of B factors of atoms in the group. The column labelled 'Q< 0.9' lists the number of atoms with occupancy less than 0.9.

Mol	Type	Chain	Res	Atoms	RSCC	RSR	B-factors(Å <sup>2</sup> )	Q<0.9
2	1YU	C	501	39/39	0.94	0.14	33,38,51,52	0
2	1YU	A	501	39/39	0.94	0.15	33,38,52,53	0
2	1YU	B	501	39/39	0.96	0.13	33,37,51,53	0

The following is a graphical depiction of the model fit to experimental electron density of all instances of the Ligand of Interest. In addition, ligands with molecular weight > 250 and outliers as shown on the geometry validation Tables will also be included. Each fit is shown from different orientation to approximate a three-dimensional view.

**Electron density around 1YU C 501:**

$2mF_o-DF_c$  (at 0.7 rmsd) in gray  
 $mF_o-DF_c$  (at 3 rmsd) in purple (negative)  
and green (positive)

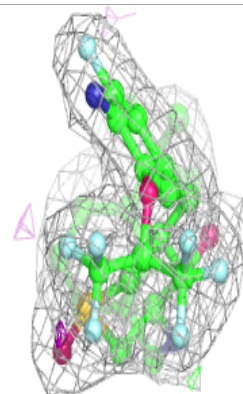
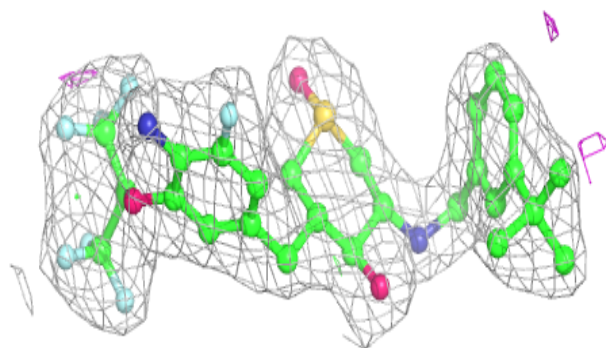
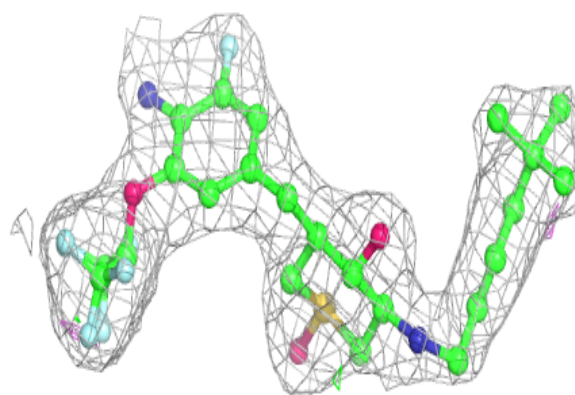
**Electron density around 1YU A 501:**

$2mF_o-DF_c$  (at 0.7 rmsd) in gray  
 $mF_o-DF_c$  (at 3 rmsd) in purple (negative)  
and green (positive)

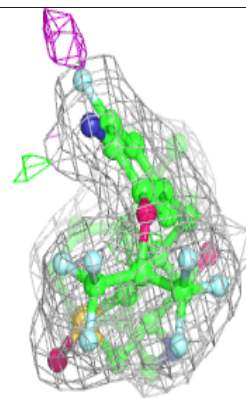
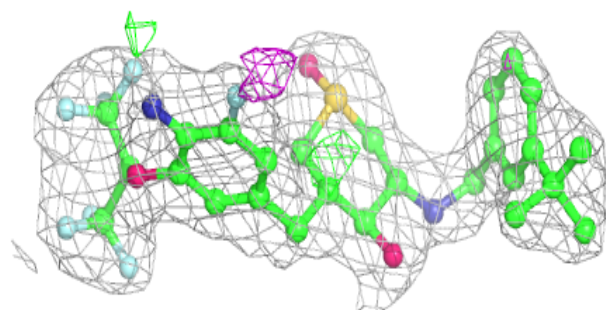
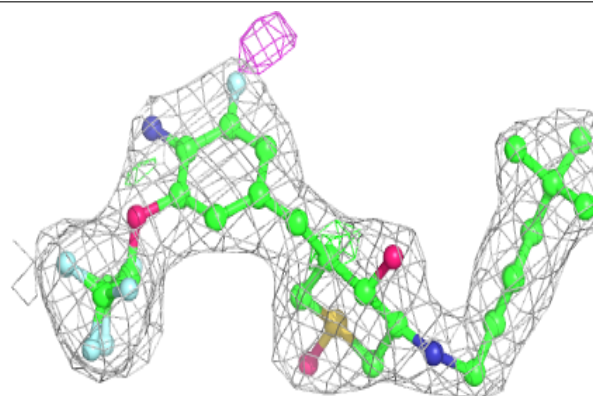

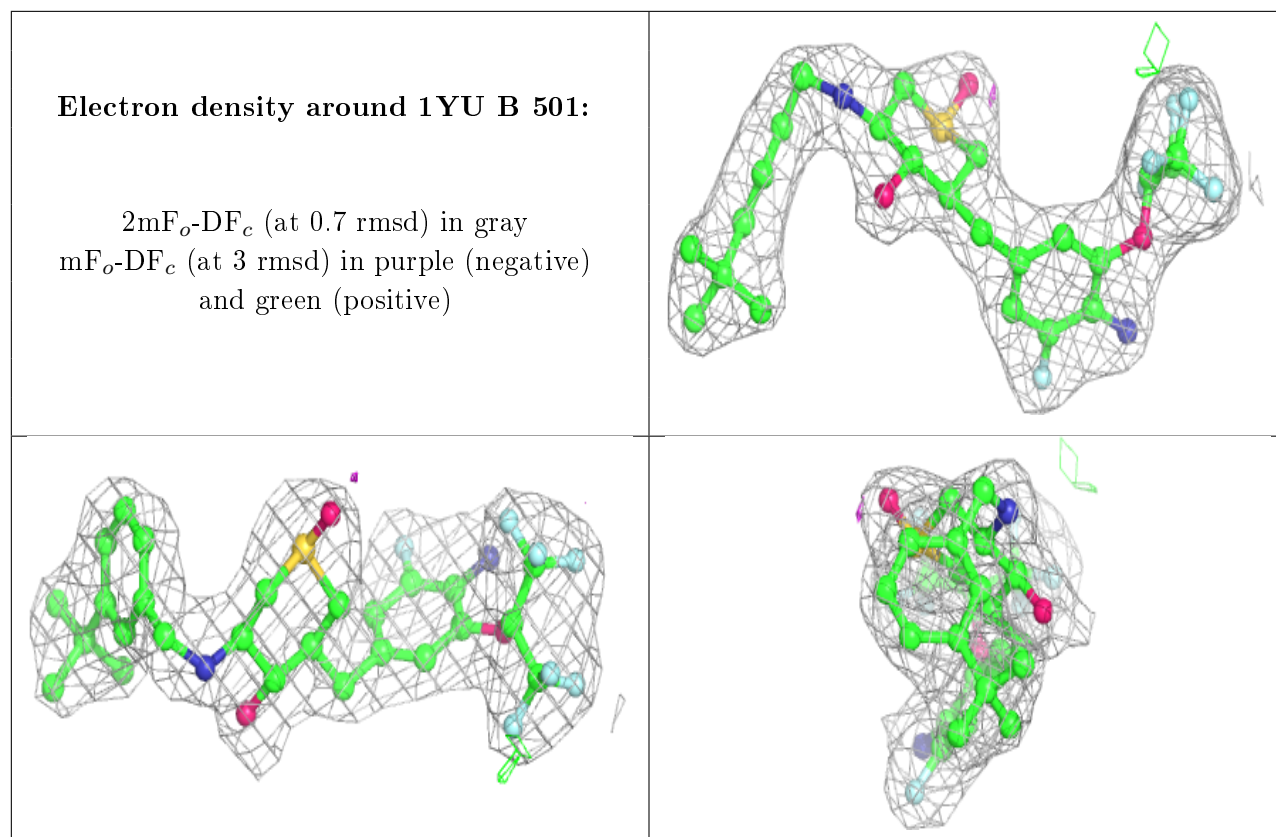

## 6.5 Other polymers [i](#)

There are no such residues in this entry.