



## Full wwPDB X-ray Structure Validation Report ⓘ

Sep 5, 2023 – 07:40 AM EDT

PDB ID : 3TIK  
Title : Sterol 14-alpha demethylase (CYP51) from Trypanosoma brucei in complex with the tipifarnib derivative 6-((4-chlorophenyl)(methoxy)(1-methyl-1H-imidazol-5-yl)methyl)-4-(2,6-difluorophenyl)-1-methylquinolin-2(1H)-one  
Authors : Hargrove, T.Y.; Wawrzak, Z.; Kraus, J.M.; Gelb, M.H.; Buckner, F.S.; Waterman, M.R.; Lepesheva, G.I.  
Deposited on : 2011-08-20  
Resolution : 2.05 Å(reported)

This is a Full wwPDB X-ray Structure Validation Report for a publicly released PDB entry.

We welcome your comments at [validation@mail.wwpdb.org](mailto:validation@mail.wwpdb.org)

A user guide is available at

<https://www.wwpdb.org/validation/2017/XrayValidationReportHelp>

with specific help available everywhere you see the ⓘ symbol.

The types of validation reports are described at

<http://www.wwpdb.org/validation/2017/FAQs#types>.

---

The following versions of software and data (see [references](#) ①) were used in the production of this report:

MolProbity : 4.02b-467  
Mogul : 1.8.5 (274361), CSD as541be (2020)  
Xtrriage (Phenix) : 1.13  
EDS : 2.35  
buster-report : 1.1.7 (2018)  
Percentile statistics : 20191225.v01 (using entries in the PDB archive December 25th 2019)  
Refmac : 5.8.0158  
CCP4 : 7.0.044 (Gargrove)  
Ideal geometry (proteins) : Engh & Huber (2001)  
Ideal geometry (DNA, RNA) : Parkinson et al. (1996)  
Validation Pipeline (wwPDB-VP) : 2.35

# 1 Overall quality at a glance i

The following experimental techniques were used to determine the structure:

*X-RAY DIFFRACTION*

The reported resolution of this entry is 2.05 Å.

Percentile scores (ranging between 0-100) for global validation metrics of the entry are shown in the following graphic. The table shows the number of entries on which the scores are based.

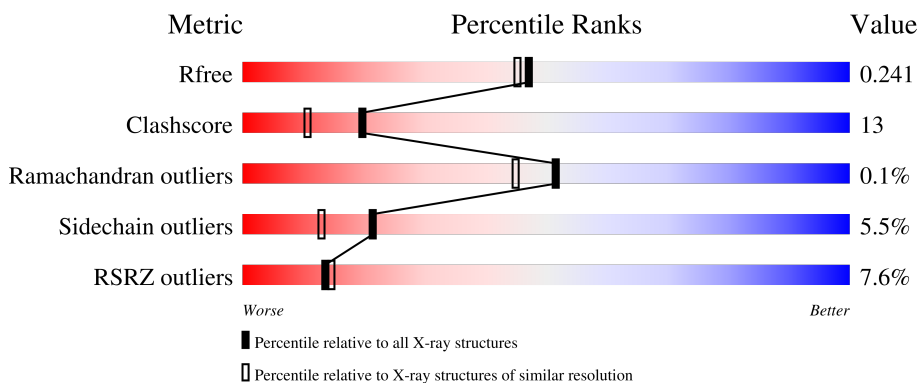

Metric	Whole archive (#Entries)	Similar resolution (#Entries, resolution range(Å))
$R_{free}$	130704	1692 (2.04-2.04)
Clashscore	141614	1773 (2.04-2.04)
Ramachandran outliers	138981	1752 (2.04-2.04)
Sidechain outliers	138945	1752 (2.04-2.04)
RSRZ outliers	127900	1672 (2.04-2.04)

The table below summarises the geometric issues observed across the polymeric chains and their fit to the electron density. The red, orange, yellow and green segments of the lower bar indicate the fraction of residues that contain outliers for  $\geq 3$ , 2, 1 and 0 types of geometric quality criteria respectively. A grey segment represents the fraction of residues that are not modelled. The numeric value for each fraction is indicated below the corresponding segment, with a dot representing fractions  $\leq 5\%$ . The upper red bar (where present) indicates the fraction of residues that have poor fit to the electron density. The numeric value is given above the bar.

Mol	Chain	Length	Quality of chain
1	A	454	<div style="display: flex; align-items: center;"> <div style="width: 10%; height: 10px; background-color: red; margin-right: 5px;"></div> <div style="width: 77%; height: 10px; background-color: green; margin-right: 5px;"></div> <div style="width: 21%; height: 10px; background-color: yellow; margin-right: 5px;"></div> <div style="width: 2%; height: 10px; background-color: orange; margin-right: 5px;"></div> <div style="width: 2%; height: 10px; background-color: grey;"></div> </div> <p style="margin-left: 10px;">10%      77%      21%    ..</p>
1	B	454	<div style="display: flex; align-items: center;"> <div style="width: 8%; height: 10px; background-color: red; margin-right: 5px;"></div> <div style="width: 78%; height: 10px; background-color: green; margin-right: 5px;"></div> <div style="width: 18%; height: 10px; background-color: yellow; margin-right: 5px;"></div> <div style="width: 2%; height: 10px; background-color: orange; margin-right: 5px;"></div> <div style="width: 2%; height: 10px; background-color: grey;"></div> </div> <p style="margin-left: 10px;">8%      78%      18%    ..</p>
1	C	454	<div style="display: flex; align-items: center;"> <div style="width: 8%; height: 10px; background-color: red; margin-right: 5px;"></div> <div style="width: 81%; height: 10px; background-color: green; margin-right: 5px;"></div> <div style="width: 17%; height: 10px; background-color: yellow; margin-right: 5px;"></div> <div style="width: 2%; height: 10px; background-color: orange; margin-right: 5px;"></div> <div style="width: 2%; height: 10px; background-color: grey;"></div> </div> <p style="margin-left: 10px;">8%      81%      17%    ..</p>
1	D	454	<div style="display: flex; align-items: center;"> <div style="width: 4%; height: 10px; background-color: red; margin-right: 5px;"></div> <div style="width: 81%; height: 10px; background-color: green; margin-right: 5px;"></div> <div style="width: 15%; height: 10px; background-color: yellow; margin-right: 5px;"></div> <div style="width: 2%; height: 10px; background-color: orange; margin-right: 5px;"></div> <div style="width: 2%; height: 10px; background-color: grey;"></div> </div> <p style="margin-left: 10px;">4%      81%      15%    ..</p>

The following table lists non-polymeric compounds, carbohydrate monomers and non-standard

residues in protein, DNA, RNA chains that are outliers for geometric or electron-density-fit criteria:

Mol	Type	Chain	Res	Chirality	Geometry	Clashes	Electron density
3	JKF	A	490	-	-	X	-
3	JKF	B	490	-	-	X	-
3	JKF	C	490	-	-	X	-
3	JKF	D	490	-	-	X	-

## 2 Entry composition i

There are 4 unique types of molecules in this entry. The entry contains 14911 atoms, of which 0 are hydrogens and 0 are deuteriums.

In the tables below, the ZeroOcc column contains the number of atoms modelled with zero occupancy, the AltConf column contains the number of residues with at least one atom in alternate conformation and the Trace column contains the number of residues modelled with at most 2 atoms.

- Molecule 1 is a protein called sterol 14-alpha demethylase (CYP51).

Mol	Chain	Residues	Atoms					ZeroOcc	AltConf	Trace
			Total	C	N	O	S			
1	A	450	3575	2283	625	640	27	0	0	0
1	B	450	3575	2283	625	640	27	0	0	0
1	C	450	3575	2283	625	640	27	0	0	0
1	D	450	3575	2283	625	640	27	0	0	0

There are 16 discrepancies between the modelled and reference sequences:

Chain	Residue	Modelled	Actual	Comment	Reference
A	28	LYS	-	expression tag	UNP Q385E8
A	29	GLY	-	expression tag	UNP Q385E8
A	30	LYS	-	expression tag	UNP Q385E8
A	31	LEU	-	expression tag	UNP Q385E8
B	28	LYS	-	expression tag	UNP Q385E8
B	29	GLY	-	expression tag	UNP Q385E8
B	30	LYS	-	expression tag	UNP Q385E8
B	31	LEU	-	expression tag	UNP Q385E8
C	28	LYS	-	expression tag	UNP Q385E8
C	29	GLY	-	expression tag	UNP Q385E8
C	30	LYS	-	expression tag	UNP Q385E8
C	31	LEU	-	expression tag	UNP Q385E8
D	28	LYS	-	expression tag	UNP Q385E8
D	29	GLY	-	expression tag	UNP Q385E8
D	30	LYS	-	expression tag	UNP Q385E8
D	31	LEU	-	expression tag	UNP Q385E8

- Molecule 2 is PROTOPORPHYRIN IX CONTAINING FE (three-letter code: HEM) (formula: C<sub>34</sub>H<sub>32</sub>FeN<sub>4</sub>O<sub>4</sub>).



Mol	Chain	Residues	Atoms				ZeroOcc	AltConf	
2	A	1	Total	C	Fe	N	O	0	0
			43	34	1	4	4		
2	B	1	Total	C	Fe	N	O	0	0
			43	34	1	4	4		
2	C	1	Total	C	Fe	N	O	0	0
			43	34	1	4	4		
2	D	1	Total	C	Fe	N	O	0	0
			43	34	1	4	4		

- Molecule 3 is 6-[(R)-(4-chlorophenyl)(methoxy)(1-methyl-1H-imidazol-5-yl)methyl]-4-(2,6-difluorophenyl)-1-methylquinolin-2(1H)-one (three-letter code: JKF) (formula:  $C_{28}H_{22}ClF_2N_3O_2$ ).

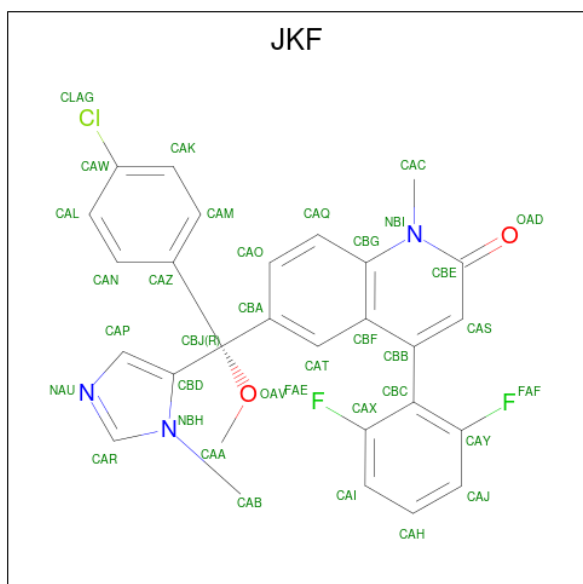

Mol	Chain	Residues	Atoms					ZeroOcc	AltConf	
3	A	1	Total	C	Cl	F	N	O	0	0
			36	28	1	2	3	2		
3	B	1	Total	C	Cl	F	N	O	0	0
			36	28	1	2	3	2		
3	C	1	Total	C	Cl	F	N	O	0	0
			36	28	1	2	3	2		
3	D	1	Total	C	Cl	F	N	O	0	0
			36	28	1	2	3	2		

- Molecule 4 is water.

Mol	Chain	Residues	Atoms		ZeroOcc	AltConf
4	A	47	Total	O	0	0
			47	47		
4	B	76	Total	O	0	0
			76	76		
4	C	59	Total	O	0	0
			59	59		
4	D	113	Total	O	0	0
			113	113		

### 3 Residue-property plots [i](#)

These plots are drawn for all protein, RNA, DNA and oligosaccharide chains in the entry. The first graphic for a chain summarises the proportions of the various outlier classes displayed in the second graphic. The second graphic shows the sequence view annotated by issues in geometry and electron density. Residues are color-coded according to the number of geometric quality criteria for which they contain at least one outlier: green = 0, yellow = 1, orange = 2 and red = 3 or more. A red dot above a residue indicates a poor fit to the electron density ( $RSRZ > 2$ ). Stretches of 2 or more consecutive residues without any outlier are shown as a green connector. Residues present in the sample, but not in the model, are shown in grey.

- Molecule 1: sterol 14-alpha demethylase (CYP51)

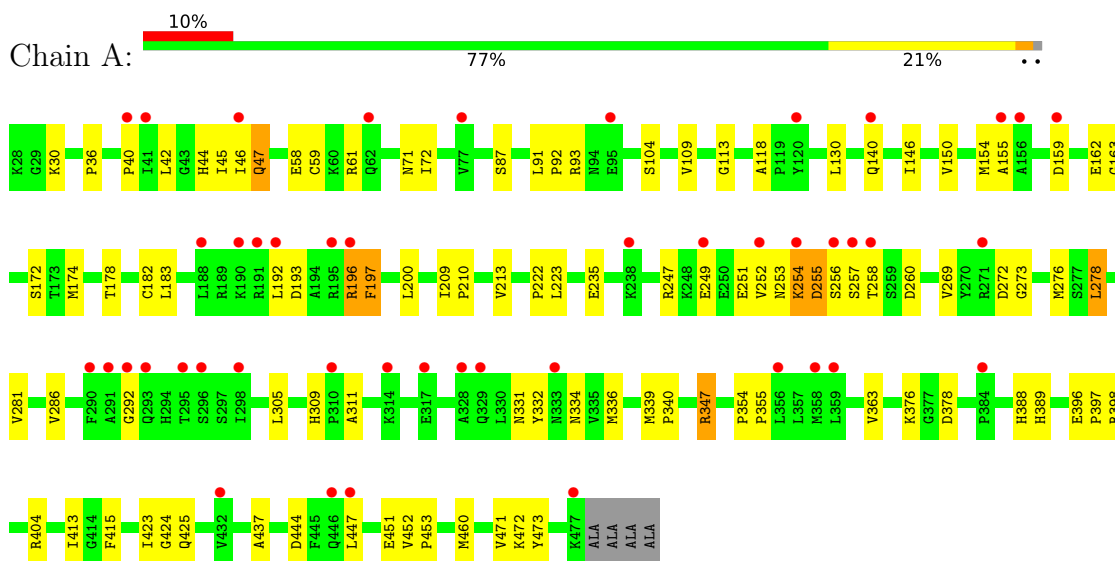

- Molecule 1: sterol 14-alpha demethylase (CYP51)

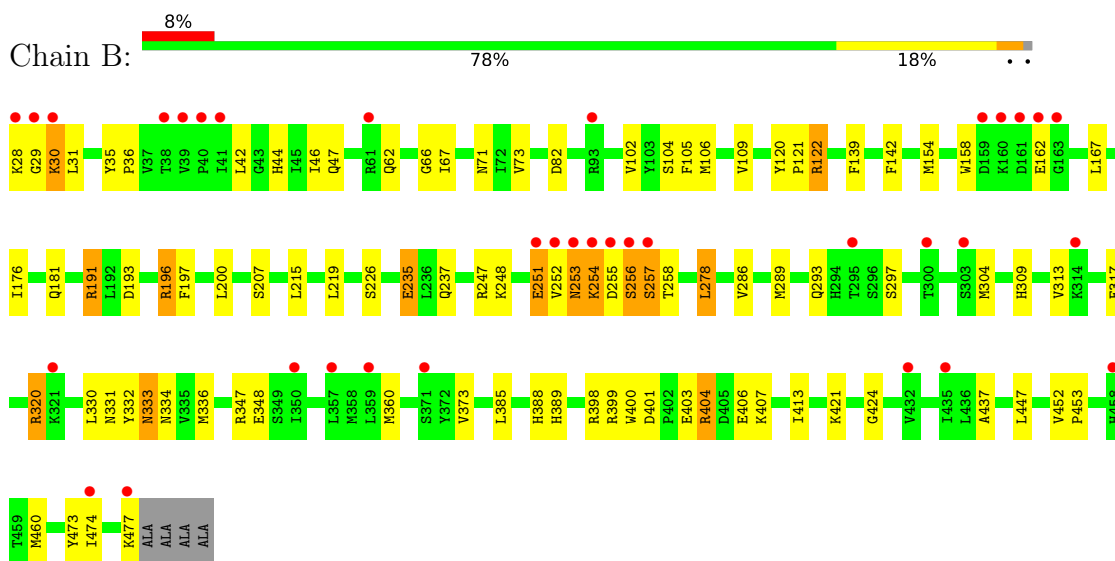

- Molecule 1: sterol 14-alpha demethylase (CYP51)



Chain C:  8% 81% 17%

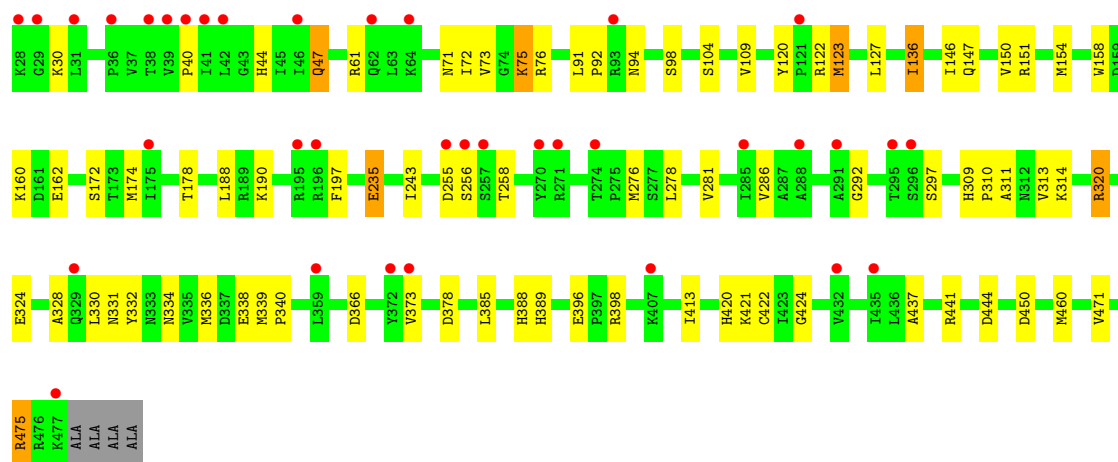

• Molecule 1: sterol 14-alpha demethylase (CYP51)

Chain D:  4% 81% 15%

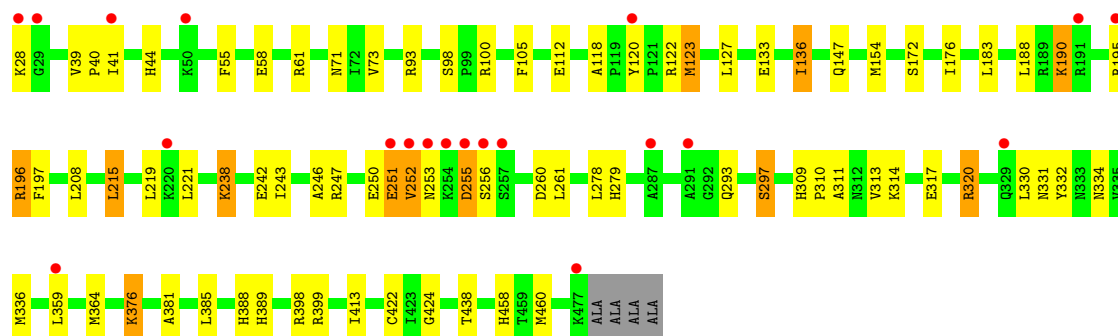

## 4 Data and refinement statistics

Property	Value	Source
Space group	P 1	Depositor
Cell constants a, b, c, $\alpha$ , $\beta$ , $\gamma$	59.72Å 79.72Å 117.52Å 74.47° 81.58° 68.05°	Depositor
Resolution (Å)	30.00 – 2.05 29.69 – 2.05	Depositor EDS
% Data completeness (in resolution range)	99.4 (30.00-2.05) 99.5 (29.69-2.05)	Depositor EDS
$R_{merge}$	0.05	Depositor
$R_{sym}$	(Not available)	Depositor
$\langle I/\sigma(I) \rangle$ <sup>1</sup>	2.35 (at 2.04Å)	Xtrriage
Refinement program	REFMAC 5.5.0109	Depositor
R, $R_{free}$	0.186 , 0.243 0.185 , 0.241	Depositor DCC
$R_{free}$ test set	6082 reflections (5.01%)	wwPDB-VP
Wilson B-factor (Å <sup>2</sup> )	41.6	Xtrriage
Anisotropy	0.083	Xtrriage
Bulk solvent $k_{sol}$ (e/Å <sup>3</sup> ), $B_{sol}$ (Å <sup>2</sup> )	0.37 , 47.7	EDS
L-test for twinning <sup>2</sup>	$\langle  L  \rangle = 0.50$ , $\langle L^2 \rangle = 0.34$	Xtrriage
Estimated twinning fraction	No twinning to report.	Xtrriage
$F_o, F_c$ correlation	0.96	EDS
Total number of atoms	14911	wwPDB-VP
Average B, all atoms (Å <sup>2</sup> )	49.0	wwPDB-VP

Xtrriage's analysis on translational NCS is as follows: *The largest off-origin peak in the Patterson function is 4.51% of the height of the origin peak. No significant pseudotranslation is detected.*

<sup>1</sup>Intensities estimated from amplitudes.

<sup>2</sup>Theoretical values of  $\langle |L| \rangle$ ,  $\langle L^2 \rangle$  for acentric reflections are 0.5, 0.333 respectively for untwinned datasets, and 0.375, 0.2 for perfectly twinned datasets.

## 5 Model quality

### 5.1 Standard geometry

Bond lengths and bond angles in the following residue types are not validated in this section: JKF, HEM

The Z score for a bond length (or angle) is the number of standard deviations the observed value is removed from the expected value. A bond length (or angle) with  $|Z| > 5$  is considered an outlier worth inspection. RMSZ is the root-mean-square of all Z scores of the bond lengths (or angles).

Mol	Chain	Bond lengths		Bond angles	
		RMSZ	# $ Z  > 5$	RMSZ	# $ Z  > 5$
1	A	0.43	1/3657 (0.0%)	0.52	0/4944
1	B	0.45	0/3657	0.56	0/4944
1	C	0.43	0/3657	0.51	0/4944
1	D	0.52	0/3657	0.59	0/4944
All	All	0.46	1/14628 (0.0%)	0.55	0/19776

Chiral center outliers are detected by calculating the chiral volume of a chiral center and verifying if the center is modelled as a planar moiety or with the opposite hand. A planarity outlier is detected by checking planarity of atoms in a peptide group, atoms in a mainchain group or atoms of a sidechain that are expected to be planar.

Mol	Chain	#Chirality outliers	#Planarity outliers
1	B	0	1

All (1) bond length outliers are listed below:

Mol	Chain	Res	Type	Atoms	Z	Observed(Å)	Ideal(Å)
1	A	59	CYS	CB-SG	-5.01	1.73	1.81

There are no bond angle outliers.

There are no chirality outliers.

All (1) planarity outliers are listed below:

Mol	Chain	Res	Type	Group
1	B	251	GLU	Peptide

## 5.2 Too-close contacts [i](#)

In the following table, the Non-H and H(model) columns list the number of non-hydrogen atoms and hydrogen atoms in the chain respectively. The H(added) column lists the number of hydrogen atoms added and optimized by MolProbity. The Clashes column lists the number of clashes within the asymmetric unit, whereas Symm-Clashes lists symmetry-related clashes.

Mol	Chain	Non-H	H(model)	H(added)	Clashes	Symm-Clashes
1	A	3575	0	3620	78	0
1	B	3575	0	3620	102	0
1	C	3575	0	3620	79	0
1	D	3575	0	3620	77	0
2	A	43	0	30	6	0
2	B	43	0	30	5	0
2	C	43	0	30	9	0
2	D	43	0	30	5	0
3	A	36	0	22	9	0
3	B	36	0	22	9	0
3	C	36	0	22	17	0
3	D	36	0	22	11	0
4	A	47	0	0	1	0
4	B	76	0	0	0	0
4	C	59	0	0	1	0
4	D	113	0	0	0	0
All	All	14911	0	14688	373	0

The all-atom clashscore is defined as the number of clashes found per 1000 atoms (including hydrogen atoms). The all-atom clashscore for this structure is 13.

All (373) close contacts within the same asymmetric unit are listed below, sorted by their clash magnitude.

Atom-1	Atom-2	Interatomic distance (Å)	Clash overlap (Å)
1:B:191:ARG:HH11	1:B:191:ARG:CG	1.61	1.14
1:A:196:ARG:CB	1:A:196:ARG:HH11	1.59	1.12
1:D:320:ARG:HH21	1:D:320:ARG:HG2	1.08	1.10
1:B:28:LYS:HD2	1:B:30:LYS:HB3	1.34	1.08
1:A:196:ARG:HB3	1:A:196:ARG:NH1	1.67	1.08
1:B:320:ARG:HG2	1:B:320:ARG:HH21	1.08	1.07
1:A:196:ARG:HH11	1:A:196:ARG:HB3	1.04	1.07
1:D:250:GLU:HB2	1:D:256:SER:HB2	1.12	1.06
1:D:250:GLU:CB	1:D:256:SER:HB2	1.86	1.05
1:B:191:ARG:HG2	1:B:191:ARG:NH1	1.50	1.04
1:B:254:LYS:HE2	1:B:254:LYS:HA	1.39	0.99

*Continued on next page...*

*Continued from previous page...*

Atom-1	Atom-2	Interatomic distance (Å)	Clash overlap (Å)
1:C:320:ARG:HG2	1:C:320:ARG:HH21	1.24	0.98
1:C:75:LYS:HB2	1:C:75:LYS:NZ	1.80	0.96
1:C:75:LYS:HB2	1:C:75:LYS:HZ2	1.33	0.93
1:B:73:VAL:HG12	1:B:73:VAL:O	1.68	0.93
1:D:251:GLU:HA	1:D:256:SER:HB3	1.51	0.93
1:D:250:GLU:HB2	1:D:256:SER:CB	1.98	0.92
1:C:44:HIS:HD2	1:C:71:ASN:H	1.07	0.92
1:D:320:ARG:HH21	1:D:320:ARG:CG	1.84	0.91
1:A:47:GLN:H	1:A:47:GLN:HE21	1.15	0.90
1:D:44:HIS:HD2	1:D:71:ASN:H	1.13	0.90
1:B:320:ARG:HH21	1:B:320:ARG:CG	1.85	0.90
1:C:460:MET:HE2	3:C:490:JKF:CAJ	2.02	0.89
1:C:389:HIS:HE1	1:C:398:ARG:HH11	1.20	0.89
1:B:122:ARG:HG2	1:B:122:ARG:HH11	1.36	0.89
1:D:388:HIS:HE1	1:D:413:ILE:H	1.19	0.89
1:D:196:ARG:HB3	1:D:196:ARG:HH11	1.37	0.89
1:C:475:ARG:CG	1:C:475:ARG:HH11	1.86	0.88
1:B:388:HIS:HE1	1:B:413:ILE:H	1.17	0.87
1:A:196:ARG:HH11	1:A:196:ARG:CG	1.88	0.87
1:C:388:HIS:HE1	1:C:413:ILE:H	1.20	0.86
1:C:276:MET:HE2	1:C:281:VAL:HG22	1.57	0.86
1:B:193:ASP:OD1	1:B:196:ARG:HG3	1.75	0.85
1:B:251:GLU:HA	1:B:256:SER:HB2	1.59	0.85
1:B:122:ARG:HH11	1:B:122:ARG:CG	1.89	0.84
1:B:320:ARG:HG2	1:B:320:ARG:NH2	1.90	0.84
1:B:109:VAL:HG13	1:B:286:VAL:HG11	1.59	0.83
1:A:388:HIS:HE1	1:A:413:ILE:H	1.23	0.83
1:C:389:HIS:CE1	1:C:398:ARG:HH11	1.98	0.82
1:D:309:HIS:HD2	1:D:311:ALA:H	1.25	0.81
1:B:191:ARG:HH11	1:B:191:ARG:HG2	0.69	0.81
1:D:320:ARG:HG2	1:D:320:ARG:NH2	1.90	0.81
1:B:122:ARG:HG2	1:B:122:ARG:NH1	1.94	0.81
1:B:253:ASN:HB2	1:B:255:ASP:H	1.45	0.81
1:C:460:MET:CE	3:C:490:JKF:CAJ	2.59	0.81
1:C:320:ARG:HH21	1:C:320:ARG:CG	1.94	0.80
1:C:47:GLN:H	1:C:47:GLN:HE21	1.30	0.80
1:A:309:HIS:CD2	1:A:311:ALA:H	2.00	0.80
1:C:460:MET:HE2	3:C:490:JKF:CAY	2.12	0.80
1:B:28:LYS:HB3	1:B:30:LYS:H	1.47	0.79
1:B:102:VAL:HG11	1:B:360:MET:HB2	1.65	0.79
1:A:260:ASP:HA	4:A:517:HOH:O	1.81	0.79

*Continued on next page...*

*Continued from previous page...*

Atom-1	Atom-2	Interatomic distance (Å)	Clash overlap (Å)
1:B:200:LEU:HD21	1:B:235:GLU:HG2	1.64	0.78
1:B:247:ARG:O	1:B:251:GLU:HB2	1.82	0.78
1:D:389:HIS:HE1	1:D:398:ARG:HH11	1.27	0.78
1:D:247:ARG:O	1:D:251:GLU:HB2	1.83	0.78
1:A:44:HIS:HD2	1:A:71:ASN:H	1.31	0.77
1:C:332:TYR:CE1	1:C:336:MET:HG3	2.20	0.77
1:C:320:ARG:O	1:C:324:GLU:HG3	1.85	0.77
1:C:460:MET:CE	3:C:490:JKF:CAY	2.64	0.76
1:A:93:ARG:HH11	1:A:93:ARG:HG2	1.49	0.76
1:B:28:LYS:HD2	1:B:30:LYS:CB	2.14	0.76
1:B:44:HIS:HD2	1:B:71:ASN:H	1.32	0.75
1:C:475:ARG:HH11	1:C:475:ARG:HG2	1.52	0.74
1:B:196:ARG:NH1	1:B:196:ARG:HB3	2.03	0.74
1:B:42:LEU:HD13	1:B:46:ILE:HD11	1.70	0.74
1:D:331:ASN:H	1:D:334:ASN:HD22	1.36	0.74
3:B:490:JKF:CAM	3:B:490:JKF:HAAB	2.18	0.73
3:B:490:JKF:CAO	3:B:490:JKF:HAN	2.17	0.73
1:C:44:HIS:CD2	1:C:71:ASN:H	1.99	0.73
1:D:399:ARG:HG3	1:D:399:ARG:HH11	1.52	0.73
1:D:44:HIS:CD2	1:D:71:ASN:H	2.02	0.72
2:B:482:HEM:HMC2	2:B:482:HEM:HBC2	1.71	0.72
1:B:401:ASP:O	1:B:404:ARG:HG2	1.88	0.71
1:A:309:HIS:HD2	1:A:311:ALA:H	1.35	0.71
1:D:251:GLU:CA	1:D:256:SER:HB3	2.21	0.70
1:B:251:GLU:CD	1:B:251:GLU:O	2.30	0.70
1:A:47:GLN:H	1:A:47:GLN:NE2	1.89	0.70
1:A:251:GLU:O	1:A:254:LYS:HD3	1.92	0.70
1:B:333:ASN:HD22	1:B:333:ASN:H	1.41	0.69
1:A:30:LYS:HG2	1:B:181:GLN:HE22	1.57	0.69
1:D:196:ARG:HH11	1:D:196:ARG:CB	2.05	0.69
1:A:155:ALA:O	1:A:159:ASP:HB3	1.94	0.68
1:B:197:PHE:CZ	1:B:289:MET:HG3	2.28	0.68
1:B:389:HIS:HE1	1:B:398:ARG:HH11	1.42	0.68
1:A:200:LEU:HD21	1:A:235:GLU:OE1	1.93	0.68
1:D:389:HIS:CE1	1:D:398:ARG:HH11	2.10	0.68
1:C:75:LYS:NZ	1:C:75:LYS:CB	2.54	0.68
1:D:188:LEU:HD13	1:D:243:ILE:HG13	1.76	0.68
1:A:253:ASN:C	1:A:254:LYS:HG2	2.12	0.67
1:B:196:ARG:CB	1:B:196:ARG:HH11	2.07	0.67
1:D:320:ARG:CG	1:D:320:ARG:NH2	2.49	0.67
3:A:490:JKF:HAN	3:A:490:JKF:CAO	2.22	0.67

*Continued on next page...*

*Continued from previous page...*

Atom-1	Atom-2	Interatomic distance (Å)	Clash overlap (Å)
1:C:309:HIS:CD2	1:C:311:ALA:H	2.13	0.67
1:B:73:VAL:O	1:B:73:VAL:CG1	2.41	0.66
1:A:210:PRO:O	1:A:213:VAL:HG23	1.96	0.66
1:A:388:HIS:CE1	1:A:413:ILE:H	2.10	0.66
1:D:388:HIS:CE1	1:D:413:ILE:H	2.10	0.66
1:D:309:HIS:CD2	1:D:311:ALA:H	2.11	0.66
1:B:196:ARG:HB3	1:B:196:ARG:HH11	1.60	0.66
1:A:58:GLU:OE1	1:A:61:ARG:NH1	2.29	0.66
1:C:320:ARG:HG2	1:C:320:ARG:NH2	2.04	0.65
1:B:388:HIS:CE1	1:B:413:ILE:H	2.06	0.65
2:D:482:HEM:HBC2	2:D:482:HEM:HMC2	1.79	0.65
1:C:424:GLY:HA3	2:C:482:HEM:C3C	2.32	0.65
1:B:248:LYS:HA	1:B:251:GLU:HB2	1.78	0.65
1:C:331:ASN:H	1:C:334:ASN:HD22	1.46	0.64
1:D:196:ARG:HB3	1:D:196:ARG:NH1	2.11	0.64
1:B:331:ASN:H	1:B:334:ASN:HD22	1.46	0.64
1:C:276:MET:CE	1:C:281:VAL:HG22	2.26	0.64
1:D:247:ARG:O	1:D:251:GLU:N	2.31	0.64
1:A:93:ARG:HG2	1:A:93:ARG:NH1	2.10	0.64
1:B:139:PHE:HA	1:B:142:PHE:HB2	1.80	0.64
1:B:385:LEU:O	1:B:389:HIS:HD2	1.80	0.64
1:D:399:ARG:HG3	1:D:399:ARG:NH1	2.12	0.63
1:B:36:PRO:O	1:B:44:HIS:HE1	1.81	0.63
1:A:309:HIS:HD2	1:A:311:ALA:N	1.97	0.62
1:C:320:ARG:CG	1:C:320:ARG:NH2	2.57	0.62
1:D:253:ASN:HB3	1:D:255:ASP:OD1	1.99	0.62
1:B:460:MET:HE2	3:B:490:JKF:CAY	2.29	0.62
2:B:482:HEM:HMB2	2:B:482:HEM:HBB2	1.81	0.62
3:C:490:JKF:HAB	3:C:490:JKF:CAT	2.30	0.62
2:C:482:HEM:CMB	2:C:482:HEM:HBB2	2.30	0.62
1:B:197:PHE:CE2	1:B:289:MET:HG3	2.35	0.61
1:A:196:ARG:NH1	1:A:196:ARG:CG	2.56	0.61
2:C:482:HEM:HBB2	2:C:482:HEM:HMB2	1.81	0.61
1:C:388:HIS:CE1	1:C:413:ILE:H	2.10	0.61
1:C:75:LYS:HB2	1:C:75:LYS:HZ3	1.66	0.60
1:C:460:MET:CE	3:C:490:JKF:HAJ	2.32	0.60
1:D:58:GLU:HA	1:D:61:ARG:NH1	2.16	0.60
1:B:251:GLU:CD	1:B:251:GLU:C	2.61	0.60
1:B:254:LYS:HA	1:B:254:LYS:CE	2.11	0.60
3:C:490:JKF:HAAB	3:C:490:JKF:CAM	2.30	0.60
1:D:332:TYR:CE1	1:D:336:MET:HG3	2.37	0.59

*Continued on next page...*

*Continued from previous page...*

Atom-1	Atom-2	Interatomic distance (Å)	Clash overlap (Å)
1:A:113:GLY:O	1:A:118:ALA:HB2	2.03	0.59
1:B:389:HIS:CE1	1:B:398:ARG:HH11	2.20	0.59
1:C:75:LYS:HZ2	1:C:75:LYS:CB	2.10	0.59
1:C:460:MET:HE1	3:C:490:JKF:HAJ	1.83	0.59
1:D:252:VAL:O	1:D:252:VAL:HG13	2.01	0.59
3:A:490:JKF:HAT	3:A:490:JKF:CAA	2.31	0.59
1:B:253:ASN:OD1	1:B:253:ASN:N	2.28	0.59
1:D:460:MET:HE2	3:D:490:JKF:CAY	2.33	0.59
1:C:136:ILE:HD12	1:C:136:ILE:C	2.23	0.59
2:D:482:HEM:HBC2	2:D:482:HEM:CMC	2.33	0.59
1:B:320:ARG:CG	1:B:320:ARG:NH2	2.50	0.59
1:D:98:SER:OG	1:D:120:TYR:OH	2.21	0.58
1:C:475:ARG:HH11	1:C:475:ARG:HG3	1.66	0.58
1:A:255:ASP:OD2	1:A:255:ASP:N	2.36	0.58
1:C:460:MET:CE	3:C:490:JKF:FAF	2.42	0.58
3:A:490:JKF:CAO	3:A:490:JKF:CAN	2.81	0.58
1:B:105:PHE:HA	1:B:219:LEU:HD21	1.85	0.58
1:B:406:GLU:O	1:C:136:ILE:HD11	2.04	0.58
1:A:45:ILE:HG23	1:A:46:ILE:HD12	1.85	0.57
1:B:30:LYS:HG2	1:B:31:LEU:H	1.68	0.57
1:C:76:ARG:NH2	1:C:378:ASP:OD2	2.37	0.57
1:C:190:LYS:NZ	1:C:190:LYS:HB3	2.18	0.57
3:B:490:JKF:CAO	3:B:490:JKF:CAN	2.81	0.57
1:C:309:HIS:HD2	1:C:311:ALA:H	1.51	0.57
3:A:490:JKF:HAT	3:A:490:JKF:HAAA	1.85	0.57
1:A:42:LEU:HD13	1:A:46:ILE:CD1	2.34	0.57
1:C:328:ALA:HA	1:C:441:ARG:HH21	1.70	0.57
1:D:246:ALA:O	1:D:250:GLU:HG3	2.03	0.57
1:A:309:HIS:CD2	1:A:311:ALA:HB3	2.40	0.57
1:B:333:ASN:H	1:B:333:ASN:ND2	2.02	0.57
1:D:331:ASN:H	1:D:334:ASN:ND2	2.03	0.57
1:C:310:PRO:O	1:C:313:VAL:HG13	2.05	0.56
1:D:251:GLU:N	1:D:256:SER:HB3	2.21	0.56
1:D:460:MET:CE	3:D:490:JKF:CAY	2.84	0.56
3:D:490:JKF:CAO	3:D:490:JKF:HAN	2.35	0.56
1:A:305:LEU:HD13	1:A:453:PRO:HG2	1.87	0.56
2:A:482:HEM:CMB	2:A:482:HEM:HBB2	2.36	0.56
2:B:482:HEM:HBB2	2:B:482:HEM:CMB	2.35	0.56
3:C:490:JKF:HAN	3:C:490:JKF:CAO	2.35	0.56
1:A:252:VAL:HG13	1:A:252:VAL:O	2.06	0.56
2:A:482:HEM:HBB2	2:A:482:HEM:HMB2	1.86	0.56

*Continued on next page...*



*Continued from previous page...*

Atom-1	Atom-2	Interatomic distance (Å)	Clash overlap (Å)
1:B:30:LYS:CG	1:B:31:LEU:H	2.19	0.56
1:B:109:VAL:CG1	1:B:286:VAL:HG11	2.33	0.56
1:C:437:ALA:O	1:C:441:ARG:HB2	2.07	0.55
1:A:109:VAL:CG1	1:A:286:VAL:HG11	2.37	0.55
1:C:94:ASN:OD1	1:C:420:HIS:NE2	2.39	0.55
2:C:482:HEM:HBC2	2:C:482:HEM:CMC	2.37	0.55
1:C:47:GLN:HE21	1:C:47:GLN:N	2.01	0.54
1:B:331:ASN:H	1:B:334:ASN:ND2	2.05	0.54
1:C:314:LYS:HB2	4:C:522:HOH:O	2.06	0.54
1:D:123:MET:HE3	1:D:127:LEU:HD12	1.89	0.54
1:A:278:LEU:O	1:A:278:LEU:HD22	2.07	0.54
1:D:253:ASN:O	1:D:255:ASP:OD2	2.25	0.54
1:D:253:ASN:C	1:D:255:ASP:H	2.10	0.54
1:D:123:MET:CE	1:D:127:LEU:HD12	2.37	0.54
3:B:490:JKF:CAM	3:B:490:JKF:CAA	2.85	0.54
1:D:105:PHE:HA	1:D:219:LEU:HD21	1.89	0.54
1:D:154:MET:HE1	1:D:438:THR:HG22	1.90	0.54
1:C:98:SER:OG	1:C:120:TYR:OH	2.22	0.54
1:A:109:VAL:HG13	1:A:286:VAL:HG11	1.90	0.53
1:C:475:ARG:CG	1:C:475:ARG:NH1	2.56	0.53
1:B:29:GLY:HA2	1:B:373:VAL:HG23	1.90	0.53
1:D:208:LEU:CD1	3:D:490:JKF:HAJ	2.38	0.53
1:B:251:GLU:HA	1:B:256:SER:CB	2.36	0.53
1:D:252:VAL:O	1:D:252:VAL:CG1	2.57	0.53
3:A:490:JKF:HAAA	3:A:490:JKF:CAT	2.38	0.53
1:B:200:LEU:CD2	1:B:235:GLU:HG2	2.37	0.53
3:B:490:JKF:HAB	3:B:490:JKF:CAT	2.38	0.53
1:C:30:LYS:O	1:C:373:VAL:HG12	2.09	0.52
1:A:460:MET:HE2	3:A:490:JKF:HAS	1.91	0.52
1:C:460:MET:HE1	3:C:490:JKF:CAJ	2.35	0.52
1:B:46:ILE:HD12	1:B:46:ILE:H	1.74	0.52
1:D:385:LEU:O	1:D:389:HIS:HD2	1.92	0.52
1:A:252:VAL:O	1:A:252:VAL:CG1	2.58	0.52
1:B:399:ARG:HG3	1:B:399:ARG:HH11	1.74	0.52
1:D:253:ASN:HB3	1:D:255:ASP:CG	2.31	0.51
1:C:475:ARG:HG3	1:C:475:ARG:NH1	2.25	0.51
1:D:172:SER:HA	1:D:297:SER:HB2	1.93	0.51
1:B:460:MET:CE	3:B:490:JKF:CAY	2.88	0.50
2:A:482:HEM:HBC2	2:A:482:HEM:CMC	2.41	0.50
1:B:399:ARG:HG3	1:B:399:ARG:NH1	2.26	0.50
1:B:237:GLN:CG	1:B:278:LEU:HD13	2.41	0.50

*Continued on next page...*

*Continued from previous page...*

Atom-1	Atom-2	Interatomic distance (Å)	Clash overlap (Å)
1:C:422:CYS:HB2	2:C:482:HEM:NA	2.26	0.50
1:B:424:GLY:HA3	2:B:482:HEM:C3C	2.47	0.50
1:A:45:ILE:HD13	1:D:221:LEU:HD22	1.94	0.50
1:A:36:PRO:O	1:A:44:HIS:HE1	1.95	0.49
1:B:309:HIS:HD2	1:B:452:VAL:HG23	1.77	0.49
3:C:490:JKF:CAO	3:C:490:JKF:CAN	2.90	0.49
1:B:67:ILE:HD13	1:B:67:ILE:N	2.26	0.49
1:C:320:ARG:NH1	1:C:444:ASP:OD2	2.44	0.49
1:D:133:GLU:HG3	1:D:261:LEU:HD12	1.94	0.49
1:A:389:HIS:HE1	1:A:398:ARG:HH11	1.60	0.49
1:C:292:GLY:HA3	2:C:482:HEM:HMC3	1.94	0.49
1:A:196:ARG:HH11	1:A:196:ARG:HG2	1.74	0.49
1:B:347:ARG:HH11	1:B:347:ARG:HB3	1.78	0.49
1:A:247:ARG:NH2	1:A:258:THR:HG21	2.27	0.49
1:C:109:VAL:CG1	1:C:286:VAL:HG11	2.43	0.49
1:A:256:SER:OG	1:A:257:SER:N	2.46	0.49
1:C:276:MET:CE	1:C:281:VAL:HA	2.43	0.49
1:D:183:LEU:O	1:D:260:ASP:HB2	2.13	0.49
1:A:42:LEU:HD13	1:A:46:ILE:HD13	1.95	0.49
1:D:255:ASP:OD2	1:D:255:ASP:N	2.45	0.49
1:B:35:TYR:HD2	1:B:44:HIS:CE1	2.31	0.48
1:B:251:GLU:O	1:B:251:GLU:OE2	2.30	0.48
1:A:162:GLU:HA	1:A:473:TYR:O	2.13	0.48
3:D:490:JKF:CAM	3:D:490:JKF:HAAB	2.43	0.48
1:C:47:GLN:H	1:C:47:GLN:NE2	2.04	0.48
3:A:490:JKF:CAA	3:A:490:JKF:CAT	2.90	0.48
1:C:44:HIS:HD2	1:C:71:ASN:N	1.92	0.48
3:C:490:JKF:CAM	3:C:490:JKF:CAP	2.88	0.48
1:B:347:ARG:HB3	1:B:347:ARG:NH1	2.29	0.48
1:C:172:SER:HB2	1:C:297:SER:OG	2.13	0.48
1:C:276:MET:CE	1:C:281:VAL:CG2	2.92	0.48
1:D:147:GLN:HE22	1:D:330:LEU:HG	1.78	0.48
1:A:42:LEU:HD13	1:A:46:ILE:HD11	1.96	0.48
1:A:272:ASP:C	1:A:272:ASP:OD1	2.52	0.48
1:D:136:ILE:HG22	1:D:336:MET:CE	2.44	0.48
1:B:255:ASP:O	1:B:257:SER:N	2.44	0.47
1:A:222:PRO:O	1:A:223:LEU:HD23	2.14	0.47
1:B:407:LYS:HA	1:C:136:ILE:HD11	1.96	0.47
1:A:347:ARG:HH11	1:A:347:ARG:HB3	1.80	0.47
1:A:424:GLY:HA3	2:A:482:HEM:C3C	2.48	0.47
1:A:209:ILE:HA	1:A:210:PRO:HD2	1.60	0.47

*Continued on next page...*

*Continued from previous page...*

Atom-1	Atom-2	Interatomic distance (Å)	Clash overlap (Å)
1:D:208:LEU:HD13	3:D:490:JKF:HAJ	1.95	0.47
1:B:154:MET:HG2	1:B:158:TRP:CE3	2.50	0.47
1:C:123:MET:HE3	1:C:127:LEU:HD12	1.97	0.47
1:D:188:LEU:CD1	1:D:243:ILE:HG13	2.42	0.47
1:C:174:MET:O	1:C:178:THR:HG23	2.14	0.47
3:D:490:JKF:HAB	3:D:490:JKF:CAT	2.45	0.47
1:B:196:ARG:NH1	1:B:196:ARG:CB	2.72	0.47
1:C:154:MET:HG2	1:C:158:TRP:CE3	2.48	0.47
1:A:309:HIS:CD2	1:A:311:ALA:CB	2.98	0.47
2:A:482:HEM:HBC2	2:A:482:HEM:HMC1	1.97	0.46
3:A:490:JKF:HAQ	3:A:490:JKF:HAC	1.70	0.46
1:B:237:GLN:HG3	1:B:278:LEU:HD13	1.96	0.46
1:C:339:MET:N	1:C:340:PRO:HD3	2.31	0.46
1:A:276:MET:CE	1:A:281:VAL:HA	2.46	0.46
1:C:146:ILE:O	1:C:150:VAL:HG23	2.15	0.46
1:B:154:MET:HE3	1:B:154:MET:HB2	1.61	0.46
1:C:314:LYS:HE3	1:C:314:LYS:HB3	1.63	0.46
1:B:251:GLU:OE1	1:B:252:VAL:HA	2.16	0.46
1:B:332:TYR:CE1	1:B:336:MET:HG3	2.51	0.46
1:B:46:ILE:HD12	1:B:46:ILE:N	2.31	0.46
1:B:66:GLY:C	1:B:67:ILE:HD13	2.37	0.46
1:B:257:SER:O	1:B:258:THR:C	2.50	0.46
1:B:313:VAL:O	1:B:317:GLU:HB2	2.15	0.46
1:A:150:VAL:O	1:A:154:MET:HG3	2.16	0.45
3:D:490:JKF:CAO	3:D:490:JKF:CAN	2.93	0.45
1:B:36:PRO:O	1:B:44:HIS:CE1	2.66	0.45
1:B:109:VAL:HG13	1:B:286:VAL:CG1	2.40	0.45
1:B:167:LEU:HD21	1:B:304:MET:HB2	1.99	0.45
1:D:100:ARG:NH2	1:D:118:ALA:O	2.50	0.45
1:A:130:LEU:HD23	1:A:423:ILE:HD11	1.98	0.45
1:B:385:LEU:O	1:B:389:HIS:CD2	2.66	0.45
3:C:490:JKF:CAX	3:C:490:JKF:HAT	2.45	0.45
1:A:331:ASN:H	1:A:334:ASN:HD22	1.64	0.45
1:B:406:GLU:O	1:C:136:ILE:CD1	2.65	0.45
2:C:482:HEM:HMB2	2:C:482:HEM:CBB	2.46	0.45
3:C:490:JKF:CAM	3:C:490:JKF:HAP	2.47	0.45
1:B:330:LEU:HD11	1:B:437:ALA:HB3	1.98	0.45
1:B:460:MET:HE2	3:B:490:JKF:CAJ	2.47	0.45
1:A:363:VAL:HG12	1:A:376:LYS:HA	1.99	0.45
1:C:424:GLY:HA3	2:C:482:HEM:C2C	2.52	0.45
1:B:333:ASN:ND2	1:B:333:ASN:N	2.65	0.44

*Continued on next page...*

*Continued from previous page...*

Atom-1	Atom-2	Interatomic distance (Å)	Clash overlap (Å)
1:B:348:GLU:HG3	1:B:400:TRP:CD1	2.53	0.44
1:B:452:VAL:HG13	1:B:453:PRO:HD2	2.00	0.44
1:C:147:GLN:NE2	1:C:151:ARG:HH12	2.14	0.44
1:D:364:MET:O	1:D:376:LYS:HE2	2.16	0.44
3:D:490:JKF:HAQ	3:D:490:JKF:HAC	1.67	0.44
1:A:87:SER:HB2	1:A:91:LEU:HD12	1.99	0.44
1:B:30:LYS:HD3	1:B:31:LEU:N	2.33	0.44
1:C:276:MET:HE1	1:C:281:VAL:HA	2.00	0.44
1:B:473:TYR:C	1:B:474:ILE:HG13	2.38	0.44
1:D:310:PRO:O	1:D:313:VAL:HG13	2.17	0.44
1:A:183:LEU:O	1:A:260:ASP:HB2	2.18	0.43
1:A:415:PHE:CD2	1:A:425:GLN:HB2	2.53	0.43
2:D:482:HEM:HBB2	2:D:482:HEM:CMB	2.47	0.43
1:D:112:GLU:O	1:D:279:HIS:HE1	2.01	0.43
1:A:249:GLU:O	1:A:253:ASN:ND2	2.51	0.43
1:A:196:ARG:NH1	1:A:196:ARG:HG2	2.29	0.43
1:A:174:MET:O	1:A:178:THR:HG23	2.19	0.43
1:A:396:GLU:N	1:A:397:PRO:CD	2.81	0.43
1:A:192:LEU:HD11	1:A:197:PHE:HA	2.01	0.43
1:C:109:VAL:HG13	1:C:286:VAL:HG11	2.01	0.43
1:C:235:GLU:O	1:C:235:GLU:HG3	2.18	0.43
1:C:385:LEU:O	1:C:389:HIS:HD2	2.01	0.43
1:A:163:GLY:O	1:A:472:LYS:HG3	2.19	0.43
1:A:332:TYR:CE1	1:A:336:MET:HG3	2.53	0.43
1:D:424:GLY:HA3	2:D:482:HEM:C3C	2.54	0.43
1:A:451:GLU:OE2	1:A:451:GLU:HA	2.19	0.42
3:A:490:JKF:CAT	3:A:490:JKF:HAB	2.48	0.42
1:C:91:LEU:N	1:C:92:PRO:CD	2.82	0.42
1:D:176:ILE:HB	1:D:293:GLN:OE1	2.18	0.42
1:D:460:MET:CE	3:D:490:JKF:CAJ	2.96	0.42
1:A:91:LEU:N	1:A:92:PRO:CD	2.82	0.42
3:B:490:JKF:HAQ	3:B:490:JKF:HAC	1.70	0.42
1:C:72:ILE:O	1:C:73:VAL:HG22	2.19	0.42
1:B:398:ARG:HA	1:B:398:ARG:HD2	1.84	0.42
3:C:490:JKF:HAB	3:C:490:JKF:FAE	2.09	0.42
1:B:30:LYS:CG	1:B:31:LEU:N	2.82	0.42
1:D:44:HIS:HB3	1:D:55:PHE:CZ	2.54	0.42
1:D:136:ILE:HG22	1:D:336:MET:HE1	2.01	0.42
1:B:120:TYR:N	1:B:121:PRO:CD	2.83	0.42
1:D:250:GLU:HB3	1:D:256:SER:HB2	1.92	0.42
1:B:109:VAL:CG1	1:B:286:VAL:CG1	2.98	0.42

*Continued on next page...*

*Continued from previous page...*

Atom-1	Atom-2	Interatomic distance (Å)	Clash overlap (Å)
1:C:338:GLU:C	1:C:340:PRO:HD3	2.40	0.42
2:C:482:HEM:CMC	2:C:482:HEM:CBC	2.97	0.42
1:D:250:GLU:C	1:D:256:SER:HB3	2.39	0.42
1:A:292:GLY:HA3	2:A:482:HEM:HMC3	2.02	0.42
1:D:460:MET:HE2	3:D:490:JKF:CAJ	2.49	0.42
1:D:422:CYS:HA	2:D:482:HEM:C4D	2.55	0.42
1:C:123:MET:CE	1:C:127:LEU:HD12	2.50	0.41
1:D:39:VAL:HA	1:D:40:PRO:HD3	1.75	0.41
1:D:190:LYS:HE2	1:D:190:LYS:HB3	1.68	0.41
1:A:45:ILE:HB	1:A:72:ILE:HG23	2.01	0.41
1:D:58:GLU:HA	1:D:61:ARG:HH12	1.83	0.41
1:A:339:MET:HE3	1:A:437:ALA:HB2	2.02	0.41
1:B:424:GLY:HA3	2:B:482:HEM:C2C	2.55	0.41
1:C:460:MET:HE1	3:C:490:JKF:CAY	2.50	0.41
1:D:136:ILE:CG2	1:D:336:MET:CE	2.98	0.41
1:A:389:HIS:CE1	1:A:398:ARG:HH11	2.38	0.41
1:B:28:LYS:CD	1:B:30:LYS:HB3	2.26	0.41
1:B:253:ASN:HB2	1:B:255:ASP:HB3	2.03	0.41
1:A:309:HIS:HD2	1:A:311:ALA:CB	2.33	0.41
1:B:67:ILE:HD11	1:B:82:ASP:HB3	2.03	0.41
1:D:359:LEU:O	1:D:381:ALA:HA	2.21	0.41
1:A:276:MET:HE1	1:A:281:VAL:HA	2.02	0.41
1:A:354:PRO:HA	1:A:355:PRO:HD3	1.96	0.41
1:D:238:LYS:HD3	1:D:242:GLU:OE2	2.21	0.41
1:D:253:ASN:CB	1:D:255:ASP:CG	2.89	0.41
1:A:339:MET:N	1:A:340:PRO:CD	2.84	0.41
1:D:73:VAL:HG11	1:D:215:LEU:HD21	2.03	0.41
1:A:146:ILE:HG13	1:A:182:CYS:SG	2.62	0.40
1:D:332:TYR:CD2	1:D:332:TYR:C	2.94	0.40
1:B:176:ILE:HB	1:B:293:GLN:OE1	2.21	0.40
1:C:147:GLN:NE2	1:C:330:LEU:HG	2.36	0.40
1:A:309:HIS:HD2	1:A:311:ALA:HB3	1.82	0.40
1:A:269:VAL:HG13	1:A:273:GLY:O	2.21	0.40
1:C:188:LEU:HD13	1:C:243:ILE:HG13	2.04	0.40

There are no symmetry-related clashes.

## 5.3 Torsion angles [i](#)

### 5.3.1 Protein backbone [i](#)

In the following table, the Percentiles column shows the percent Ramachandran outliers of the chain as a percentile score with respect to all X-ray entries followed by that with respect to entries of similar resolution.

The Analysed column shows the number of residues for which the backbone conformation was analysed, and the total number of residues.

Mol	Chain	Analysed	Favoured	Allowed	Outliers	Percentiles	
1	A	448/454 (99%)	432 (96%)	15 (3%)	1 (0%)	47	39
1	B	448/454 (99%)	434 (97%)	14 (3%)	0	100	100
1	C	448/454 (99%)	429 (96%)	18 (4%)	1 (0%)	47	39
1	D	448/454 (99%)	436 (97%)	12 (3%)	0	100	100
All	All	1792/1816 (99%)	1731 (97%)	59 (3%)	2 (0%)	51	45

All (2) Ramachandran outliers are listed below:

Mol	Chain	Res	Type
1	C	40	PRO
1	A	40	PRO

### 5.3.2 Protein sidechains [i](#)

In the following table, the Percentiles column shows the percent sidechain outliers of the chain as a percentile score with respect to all X-ray entries followed by that with respect to entries of similar resolution.

The Analysed column shows the number of residues for which the sidechain conformation was analysed, and the total number of residues.

Mol	Chain	Analysed	Rotameric	Outliers	Percentiles	
1	A	392/392 (100%)	375 (96%)	17 (4%)	29	22
1	B	392/392 (100%)	366 (93%)	26 (7%)	16	9
1	C	392/392 (100%)	370 (94%)	22 (6%)	21	12
1	D	392/392 (100%)	370 (94%)	22 (6%)	21	12
All	All	1568/1568 (100%)	1481 (94%)	87 (6%)	21	13

All (87) residues with a non-rotameric sidechain are listed below:

Mol	Chain	Res	Type
1	A	47	GLN
1	A	104	SER
1	A	140	GLN
1	A	172	SER
1	A	193	ASP
1	A	196	ARG
1	A	197	PHE
1	A	254	LYS
1	A	255	ASP
1	A	278	LEU
1	A	347	ARG
1	A	378	ASP
1	A	404	ARG
1	A	444	ASP
1	A	447	LEU
1	A	452	VAL
1	A	471	VAL
1	B	30	LYS
1	B	47	GLN
1	B	62	GLN
1	B	104	SER
1	B	106	MET
1	B	122	ARG
1	B	162	GLU
1	B	191	ARG
1	B	196	ARG
1	B	207	SER
1	B	215	LEU
1	B	226	SER
1	B	235	GLU
1	B	253	ASN
1	B	254	LYS
1	B	256	SER
1	B	257	SER
1	B	278	LEU
1	B	297	SER
1	B	320	ARG
1	B	333	ASN
1	B	403	GLU
1	B	404	ARG
1	B	421	LYS
1	B	447	LEU
1	B	477	LYS

*Continued on next page...*

*Continued from previous page...*

<b>Mol</b>	<b>Chain</b>	<b>Res</b>	<b>Type</b>
1	C	47	GLN
1	C	61	ARG
1	C	75	LYS
1	C	104	SER
1	C	122	ARG
1	C	123	MET
1	C	136	ILE
1	C	160	LYS
1	C	162	GLU
1	C	197	PHE
1	C	235	GLU
1	C	255	ASP
1	C	256	SER
1	C	258	THR
1	C	278	LEU
1	C	320	ARG
1	C	366	ASP
1	C	396	GLU
1	C	421	LYS
1	C	450	ASP
1	C	471	VAL
1	C	475	ARG
1	D	28	LYS
1	D	41	ILE
1	D	93	ARG
1	D	122	ARG
1	D	123	MET
1	D	136	ILE
1	D	190	LYS
1	D	195	ARG
1	D	196	ARG
1	D	197	PHE
1	D	215	LEU
1	D	238	LYS
1	D	251	GLU
1	D	252	VAL
1	D	255	ASP
1	D	278	LEU
1	D	297	SER
1	D	314	LYS
1	D	317	GLU
1	D	320	ARG

*Continued on next page...*



*Continued from previous page...*

Mol	Chain	Res	Type
1	D	376	LYS
1	D	458	HIS

Sometimes sidechains can be flipped to improve hydrogen bonding and reduce clashes. All (32) such sidechains are listed below:

Mol	Chain	Res	Type
1	A	44	HIS
1	A	47	GLN
1	A	140	GLN
1	A	279	HIS
1	A	309	HIS
1	A	334	ASN
1	A	388	HIS
1	A	389	HIS
1	A	446	GLN
1	B	44	HIS
1	B	181	GLN
1	B	279	HIS
1	B	306	HIS
1	B	333	ASN
1	B	334	ASN
1	B	388	HIS
1	B	389	HIS
1	B	446	GLN
1	C	44	HIS
1	C	47	GLN
1	C	279	HIS
1	C	309	HIS
1	C	334	ASN
1	C	388	HIS
1	C	389	HIS
1	C	446	GLN
1	D	44	HIS
1	D	279	HIS
1	D	309	HIS
1	D	334	ASN
1	D	388	HIS
1	D	389	HIS

### 5.3.3 RNA [i](#)

There are no RNA molecules in this entry.

## 5.4 Non-standard residues in protein, DNA, RNA chains [i](#)

There are no non-standard protein/DNA/RNA residues in this entry.

## 5.5 Carbohydrates [i](#)

There are no monosaccharides in this entry.

## 5.6 Ligand geometry [i](#)

8 ligands are modelled in this entry.

In the following table, the Counts columns list the number of bonds (or angles) for which Mogul statistics could be retrieved, the number of bonds (or angles) that are observed in the model and the number of bonds (or angles) that are defined in the Chemical Component Dictionary. The Link column lists molecule types, if any, to which the group is linked. The Z score for a bond length (or angle) is the number of standard deviations the observed value is removed from the expected value. A bond length (or angle) with  $|Z| > 2$  is considered an outlier worth inspection. RMSZ is the root-mean-square of all Z scores of the bond lengths (or angles).

Mol	Type	Chain	Res	Link	Bond lengths			Bond angles		
					Counts	RMSZ	# Z  > 2	Counts	RMSZ	# Z  > 2
3	JKF	D	490	2	37,40,40	2.30	8 (21%)	54,60,60	1.65	7 (12%)
3	JKF	B	490	2	37,40,40	2.68	9 (24%)	54,60,60	1.55	8 (14%)
2	HEM	B	482	1,3	41,50,50	1.88	7 (17%)	45,82,82	1.66	10 (22%)
2	HEM	A	482	1,3	41,50,50	1.93	8 (19%)	45,82,82	1.51	7 (15%)
3	JKF	A	490	2	37,40,40	2.56	7 (18%)	54,60,60	1.68	11 (20%)
2	HEM	D	482	1,3	41,50,50	1.87	5 (12%)	45,82,82	1.55	6 (13%)
2	HEM	C	482	1,3	41,50,50	1.94	7 (17%)	45,82,82	1.78	10 (22%)
3	JKF	C	490	2	37,40,40	2.42	8 (21%)	54,60,60	1.55	11 (20%)

In the following table, the Chirals column lists the number of chiral outliers, the number of chiral centers analysed, the number of these observed in the model and the number defined in the Chemical Component Dictionary. Similar counts are reported in the Torsion and Rings columns. '-' means no outliers of that kind were identified.

Mol	Type	Chain	Res	Link	Chirals	Torsions	Rings
3	JKF	D	490	2	-	4/19/25/25	0/5/5/5
3	JKF	B	490	2	-	9/19/25/25	0/5/5/5
2	HEM	B	482	1,3	-	0/12/54/54	-
2	HEM	A	482	1,3	-	2/12/54/54	-
3	JKF	A	490	2	-	4/19/25/25	0/5/5/5
2	HEM	D	482	1,3	-	0/12/54/54	-
2	HEM	C	482	1,3	-	0/12/54/54	-
3	JKF	C	490	2	-	10/19/25/25	0/5/5/5

All (59) bond length outliers are listed below:

Mol	Chain	Res	Type	Atoms	Z	Observed(Å)	Ideal(Å)
3	A	490	JKF	CBJ-CBA	-9.32	1.38	1.53
3	C	490	JKF	CBJ-CBA	-8.86	1.38	1.53
3	A	490	JKF	CBJ-CAZ	-8.16	1.39	1.53
2	C	482	HEM	C3D-C2D	7.56	1.52	1.36
3	B	490	JKF	CBJ-CBA	-7.51	1.41	1.53
3	B	490	JKF	CBJ-CAZ	-7.48	1.41	1.53
2	D	482	HEM	C3D-C2D	7.44	1.52	1.36
2	B	482	HEM	C3D-C2D	7.39	1.52	1.36
3	D	490	JKF	CBJ-CBA	-7.29	1.41	1.53
2	A	482	HEM	C3D-C2D	7.24	1.52	1.36
3	D	490	JKF	CBJ-CAZ	-7.15	1.41	1.53
3	C	490	JKF	CBJ-CAZ	-7.09	1.41	1.53
3	B	490	JKF	FAF-CAY	-6.15	1.19	1.35
3	B	490	JKF	FAE-CAX	-5.98	1.20	1.35
3	C	490	JKF	CBC-CBB	-5.84	1.39	1.50
3	A	490	JKF	CBC-CBB	-5.49	1.39	1.50
3	B	490	JKF	CBC-CBB	-5.41	1.40	1.50
2	C	482	HEM	C3C-C2C	-5.41	1.32	1.40
2	A	482	HEM	C3C-C2C	-4.99	1.33	1.40
3	D	490	JKF	CBC-CBB	-4.58	1.41	1.50
2	B	482	HEM	C3C-CAC	4.09	1.56	1.47
3	A	490	JKF	FAF-CAY	-4.07	1.25	1.35
2	D	482	HEM	C3C-C2C	-4.02	1.34	1.40
3	D	490	JKF	CAS-CBB	3.83	1.40	1.35
2	B	482	HEM	C3C-C2C	-3.74	1.35	1.40
3	D	490	JKF	FAF-CAY	-3.66	1.26	1.35
2	A	482	HEM	C3C-CAC	3.60	1.55	1.47
3	B	490	JKF	CBF-CBB	-3.53	1.40	1.47
2	D	482	HEM	C3C-CAC	3.50	1.55	1.47
3	D	490	JKF	CBF-CBB	-3.33	1.40	1.47

*Continued on next page...*

Continued from previous page...

Mol	Chain	Res	Type	Atoms	Z	Observed(Å)	Ideal(Å)
3	A	490	JKF	CBF-CBB	-3.27	1.40	1.47
3	B	490	JKF	CAS-CBB	3.21	1.39	1.35
3	C	490	JKF	CAS-CBB	3.18	1.39	1.35
2	D	482	HEM	CAB-C3B	3.06	1.55	1.47
2	C	482	HEM	C3C-CAC	2.99	1.53	1.47
3	C	490	JKF	CBF-CBB	-2.98	1.41	1.47
3	C	490	JKF	CAW-CLAG	2.96	1.80	1.74
2	B	482	HEM	CAB-C3B	2.83	1.55	1.47
2	C	482	HEM	CAB-C3B	2.69	1.54	1.47
3	A	490	JKF	CAS-CBB	2.67	1.38	1.35
3	B	490	JKF	CBG-NBI	-2.66	1.35	1.40
2	A	482	HEM	CAA-C2A	2.60	1.55	1.52
3	D	490	JKF	CBG-NBI	-2.53	1.35	1.40
2	A	482	HEM	CAB-C3B	2.51	1.54	1.47
3	A	490	JKF	CBG-NBI	-2.50	1.35	1.40
2	D	482	HEM	CMB-C2B	2.42	1.55	1.50
2	B	482	HEM	CMB-C2B	2.28	1.55	1.50
2	B	482	HEM	CAA-C2A	2.28	1.55	1.52
2	A	482	HEM	CMB-C2B	2.28	1.55	1.50
2	A	482	HEM	CMC-C2C	2.25	1.56	1.51
2	B	482	HEM	CMD-C2D	2.24	1.55	1.50
2	C	482	HEM	CAA-C2A	2.19	1.55	1.52
2	C	482	HEM	CMB-C2B	2.15	1.55	1.50
2	A	482	HEM	CMD-C2D	2.14	1.55	1.50
3	C	490	JKF	CBG-NBI	-2.11	1.36	1.40
3	D	490	JKF	CBE-NBI	-2.06	1.34	1.40
3	C	490	JKF	FAF-CAY	-2.05	1.30	1.35
3	B	490	JKF	CBE-NBI	-2.03	1.34	1.40
2	C	482	HEM	FE-ND	2.02	2.06	1.96

All (70) bond angle outliers are listed below:

Mol	Chain	Res	Type	Atoms	Z	Observed(°)	Ideal(°)
3	A	490	JKF	CAS-CBE-NBI	6.14	121.67	115.42
3	B	490	JKF	CAS-CBE-NBI	5.96	121.49	115.42
2	C	482	HEM	C4D-ND-C1D	5.92	111.19	105.07
3	D	490	JKF	CAS-CBE-NBI	5.77	121.29	115.42
3	C	490	JKF	CAS-CBE-NBI	5.18	120.69	115.42
2	B	482	HEM	C4D-ND-C1D	5.09	110.33	105.07
2	D	482	HEM	C4D-ND-C1D	4.88	110.11	105.07
3	A	490	JKF	CAB-NBH-CBD	4.86	130.34	124.35
2	A	482	HEM	C4D-ND-C1D	4.74	109.97	105.07

Continued on next page...

*Continued from previous page...*

Mol	Chain	Res	Type	Atoms	Z	Observed(°)	Ideal(°)
3	D	490	JKF	CAB-NBH-CBD	4.45	129.83	124.35
3	D	490	JKF	CBD-CBJ-CBA	-3.37	104.32	110.80
3	A	490	JKF	CAX-CBC-CBB	-3.18	118.72	122.32
3	B	490	JKF	CAX-CBC-CBB	-3.18	118.72	122.32
2	C	482	HEM	CMA-C3A-C4A	-3.18	123.57	128.46
3	D	490	JKF	NAU-CAR-NBH	-3.14	107.59	112.26
2	C	482	HEM	C4A-C3A-C2A	3.11	109.16	107.00
2	A	482	HEM	C4C-CHD-C1D	3.07	126.61	122.56
2	B	482	HEM	C4C-CHD-C1D	3.04	126.58	122.56
3	B	490	JKF	NAU-CAR-NBH	-2.99	107.82	112.26
3	C	490	JKF	NAU-CAR-NBH	-2.99	107.83	112.26
3	A	490	JKF	NAU-CAR-NBH	-2.88	107.98	112.26
3	D	490	JKF	CBG-NBI-CBE	-2.85	120.34	123.04
3	C	490	JKF	CAB-NBH-CBD	2.82	127.83	124.35
3	B	490	JKF	CBD-CBJ-CBA	-2.80	105.43	110.80
2	C	482	HEM	CHD-C1D-ND	2.75	127.41	124.43
2	B	482	HEM	C1B-NB-C4B	2.75	107.91	105.07
3	B	490	JKF	CBB-CAS-CBE	-2.74	119.19	122.65
2	C	482	HEM	C2C-C3C-C4C	2.70	108.78	106.90
2	A	482	HEM	CHC-C4B-NB	2.70	127.37	124.43
3	A	490	JKF	CBG-NBI-CBE	-2.70	120.48	123.04
3	A	490	JKF	CBB-CAS-CBE	-2.70	119.24	122.65
2	B	482	HEM	CBA-CAA-C2A	-2.68	108.05	112.62
2	B	482	HEM	CBD-CAD-C3D	-2.65	105.26	112.63
3	B	490	JKF	CAB-NBH-CBD	2.59	127.54	124.35
3	B	490	JKF	CBG-NBI-CBE	-2.59	120.59	123.04
3	A	490	JKF	OAD-CBE-CAS	-2.57	119.15	125.72
2	C	482	HEM	CBD-CAD-C3D	-2.55	105.54	112.63
2	A	482	HEM	C2C-C3C-C4C	2.54	108.67	106.90
2	B	482	HEM	O1D-CGD-CBD	-2.53	114.95	123.08
2	C	482	HEM	C4C-CHD-C1D	2.52	125.89	122.56
3	C	490	JKF	CBD-CBJ-CBA	-2.51	105.98	110.80
2	B	482	HEM	CHD-C1D-ND	2.50	127.14	124.43
3	C	490	JKF	OAD-CBE-CAS	-2.48	119.37	125.72
3	B	490	JKF	OAD-CBE-CAS	-2.45	119.44	125.72
3	C	490	JKF	CAN-CAL-CAW	2.43	121.80	119.24
3	D	490	JKF	CBB-CAS-CBE	-2.41	119.61	122.65
2	A	482	HEM	CMA-C3A-C4A	-2.36	124.83	128.46
2	B	482	HEM	O2A-CGA-CBA	2.35	121.58	114.03
3	A	490	JKF	CAQ-CAO-CBA	-2.25	118.20	121.22
3	C	490	JKF	CBG-NBI-CBE	-2.24	120.92	123.04
2	C	482	HEM	C4B-CHC-C1C	2.23	125.50	122.56

*Continued on next page...*

*Continued from previous page...*

Mol	Chain	Res	Type	Atoms	Z	Observed(°)	Ideal(°)
3	D	490	JKF	FAE-CAX-CBC	2.22	121.48	118.01
2	D	482	HEM	CHC-C4B-NB	2.21	126.83	124.43
2	D	482	HEM	CBA-CAA-C2A	-2.20	108.86	112.62
2	D	482	HEM	C1B-NB-C4B	2.18	107.32	105.07
2	B	482	HEM	C4A-C3A-C2A	2.17	108.50	107.00
3	C	490	JKF	CAY-CBC-CAX	2.16	118.95	114.97
2	C	482	HEM	C1B-NB-C4B	2.16	107.31	105.07
3	C	490	JKF	CAP-NAU-CAR	2.14	109.12	105.78
3	A	490	JKF	CAY-CBC-CAX	2.13	118.90	114.97
2	A	482	HEM	CMD-C2D-C1D	2.13	128.28	125.04
3	C	490	JKF	CAX-CBC-CBB	-2.11	119.93	122.32
3	A	490	JKF	CAP-NAU-CAR	2.10	109.06	105.78
3	C	490	JKF	CBB-CAS-CBE	-2.10	119.99	122.65
2	C	482	HEM	CHC-C4B-NB	2.10	126.71	124.43
2	D	482	HEM	CMA-C3A-C4A	-2.09	125.25	128.46
2	A	482	HEM	CAD-CBD-CGD	-2.06	109.17	113.60
3	A	490	JKF	CBD-CBJ-CBA	-2.06	106.85	110.80
2	D	482	HEM	CMC-C2C-C3C	2.05	128.51	124.68
2	B	482	HEM	O2D-CGD-CBD	2.01	120.50	114.03

There are no chirality outliers.

All (29) torsion outliers are listed below:

Mol	Chain	Res	Type	Atoms
3	C	490	JKF	CAZ-CBJ-OAV-CAA
3	C	490	JKF	CBA-CBJ-OAV-CAA
3	C	490	JKF	CBD-CBJ-OAV-CAA
3	C	490	JKF	CBF-CBB-CBC-CAY
3	C	490	JKF	CBF-CBB-CBC-CAX
3	B	490	JKF	CAN-CAZ-CBJ-OAV
3	A	490	JKF	CAN-CAZ-CBJ-OAV
3	D	490	JKF	CAN-CAZ-CBJ-OAV
3	B	490	JKF	CAZ-CBJ-OAV-CAA
3	B	490	JKF	CBA-CBJ-OAV-CAA
3	C	490	JKF	CAN-CAZ-CBJ-CBA
3	D	490	JKF	CAN-CAZ-CBJ-CBA
3	B	490	JKF	CAM-CAZ-CBJ-CBD
3	A	490	JKF	CAN-CAZ-CBJ-CBA
3	B	490	JKF	CAM-CAZ-CBJ-OAV
3	C	490	JKF	CAN-CAZ-CBJ-OAV
3	A	490	JKF	CAM-CAZ-CBJ-OAV
3	D	490	JKF	CAM-CAZ-CBJ-OAV

*Continued on next page...*

*Continued from previous page...*

Mol	Chain	Res	Type	Atoms
3	B	490	JKF	CAN-CAZ-CBJ-CBA
3	B	490	JKF	CBD-CBJ-OAV-CAA
3	C	490	JKF	CAM-CAZ-CBJ-CBA
2	A	482	HEM	CAD-CBD-CGD-O2D
3	B	490	JKF	CAN-CAZ-CBJ-CBD
3	D	490	JKF	CAM-CAZ-CBJ-CBA
3	A	490	JKF	CAM-CAZ-CBJ-CBA
2	A	482	HEM	CAD-CBD-CGD-O1D
3	B	490	JKF	CAT-CBA-CBJ-CBD
3	C	490	JKF	CAT-CBA-CBJ-CBD
3	C	490	JKF	CAS-CBB-CBC-CAY

There are no ring outliers.

8 monomers are involved in 71 short contacts:

Mol	Chain	Res	Type	Clashes	Symm-Clashes
3	D	490	JKF	11	0
3	B	490	JKF	9	0
2	B	482	HEM	5	0
2	A	482	HEM	6	0
3	A	490	JKF	9	0
2	D	482	HEM	5	0
2	C	482	HEM	9	0
3	C	490	JKF	17	0

The following is a two-dimensional graphical depiction of Mogul quality analysis of bond lengths, bond angles, torsion angles, and ring geometry for all instances of the Ligand of Interest. In addition, ligands with molecular weight > 250 and outliers as shown on the validation Tables will also be included. For torsion angles, if less than 5% of the Mogul distribution of torsion angles is within 10 degrees of the torsion angle in question, then that torsion angle is considered an outlier. Any bond that is central to one or more torsion angles identified as an outlier by Mogul will be highlighted in the graph. For rings, the root-mean-square deviation (RMSD) between the ring in question and similar rings identified by Mogul is calculated over all ring torsion angles. If the average RMSD is greater than 60 degrees and the minimal RMSD between the ring in question and any Mogul-identified rings is also greater than 60 degrees, then that ring is considered an outlier. The outliers are highlighted in purple. The color gray indicates Mogul did not find sufficient equivalents in the CSD to analyse the geometry.

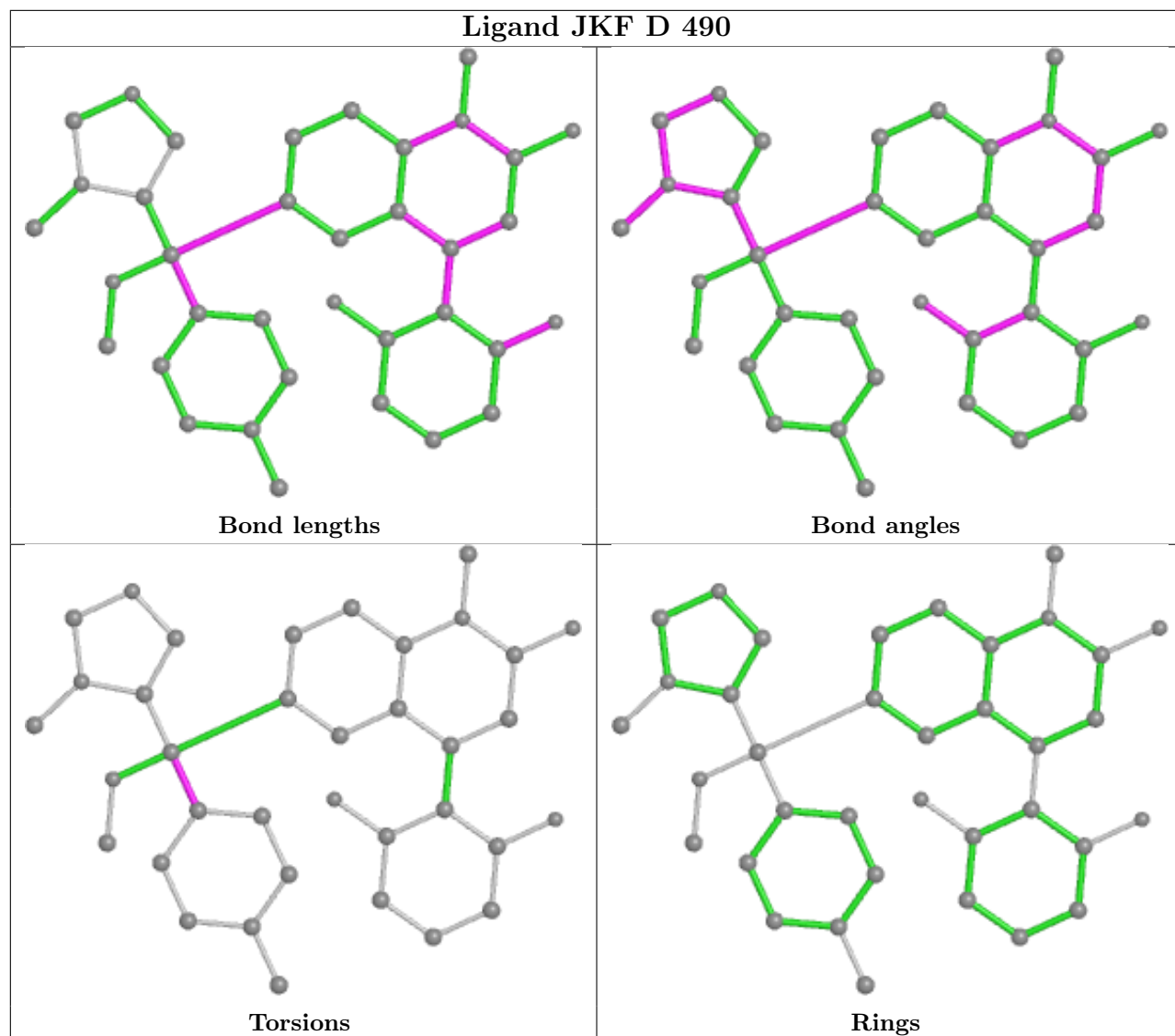



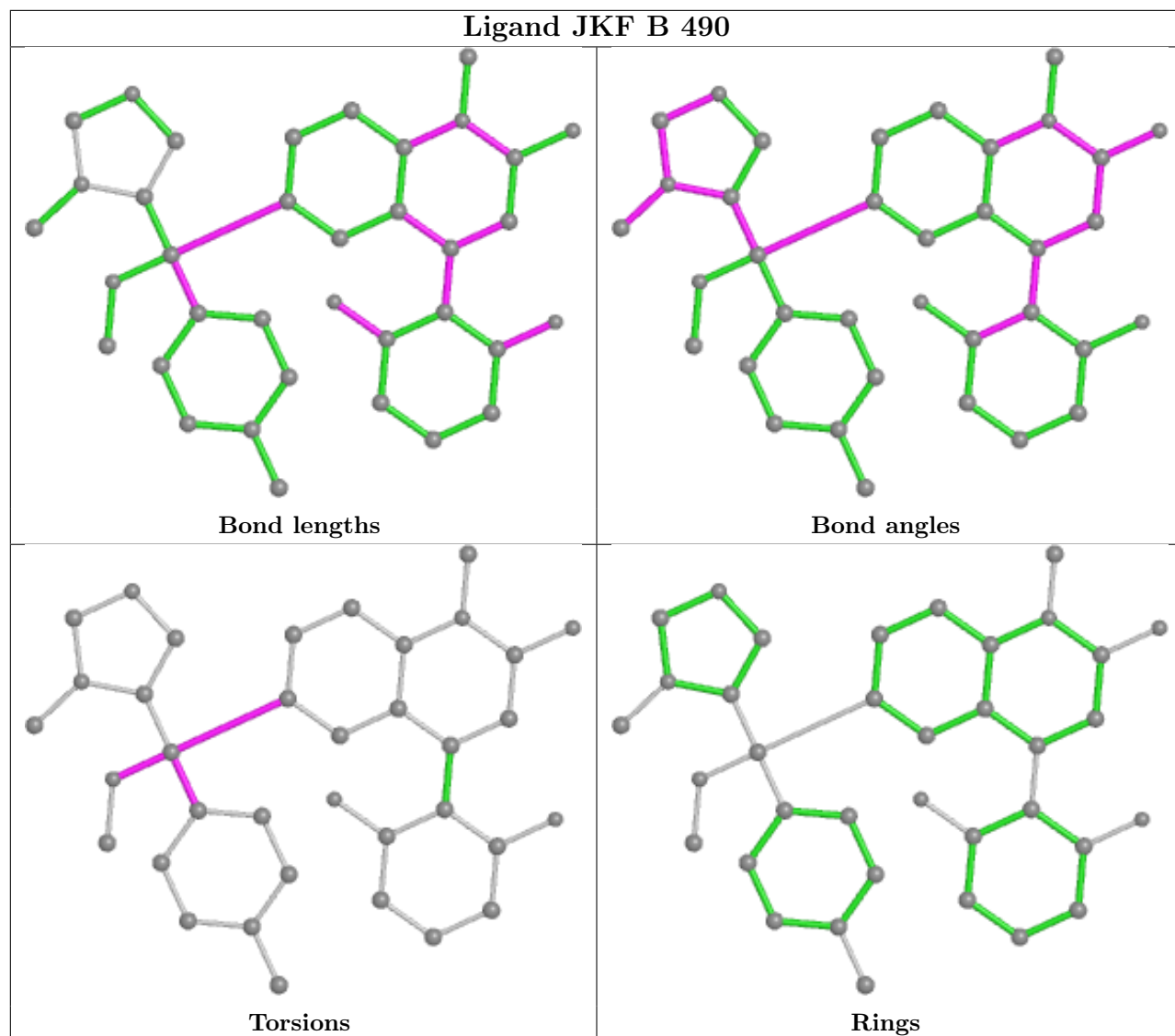

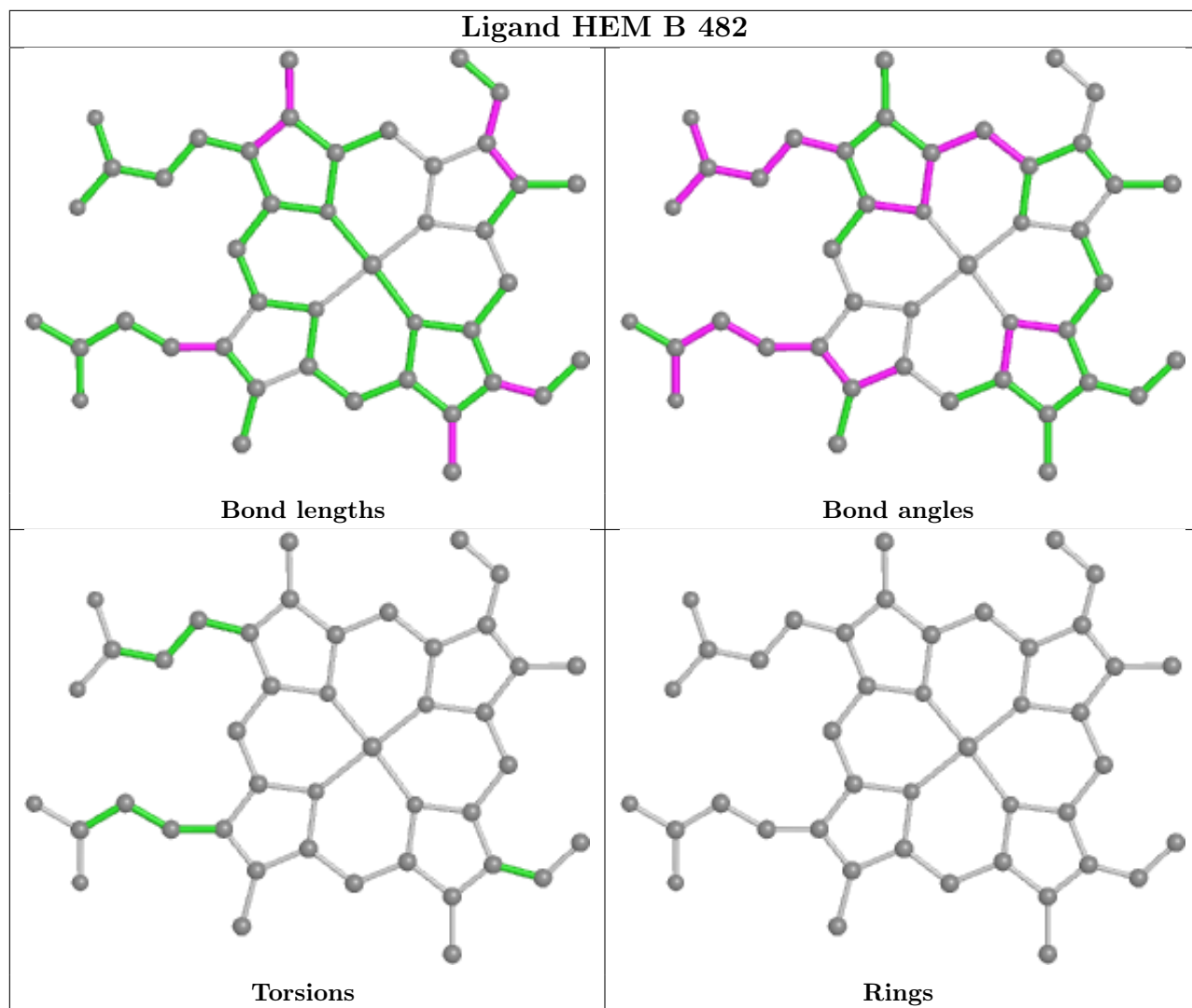

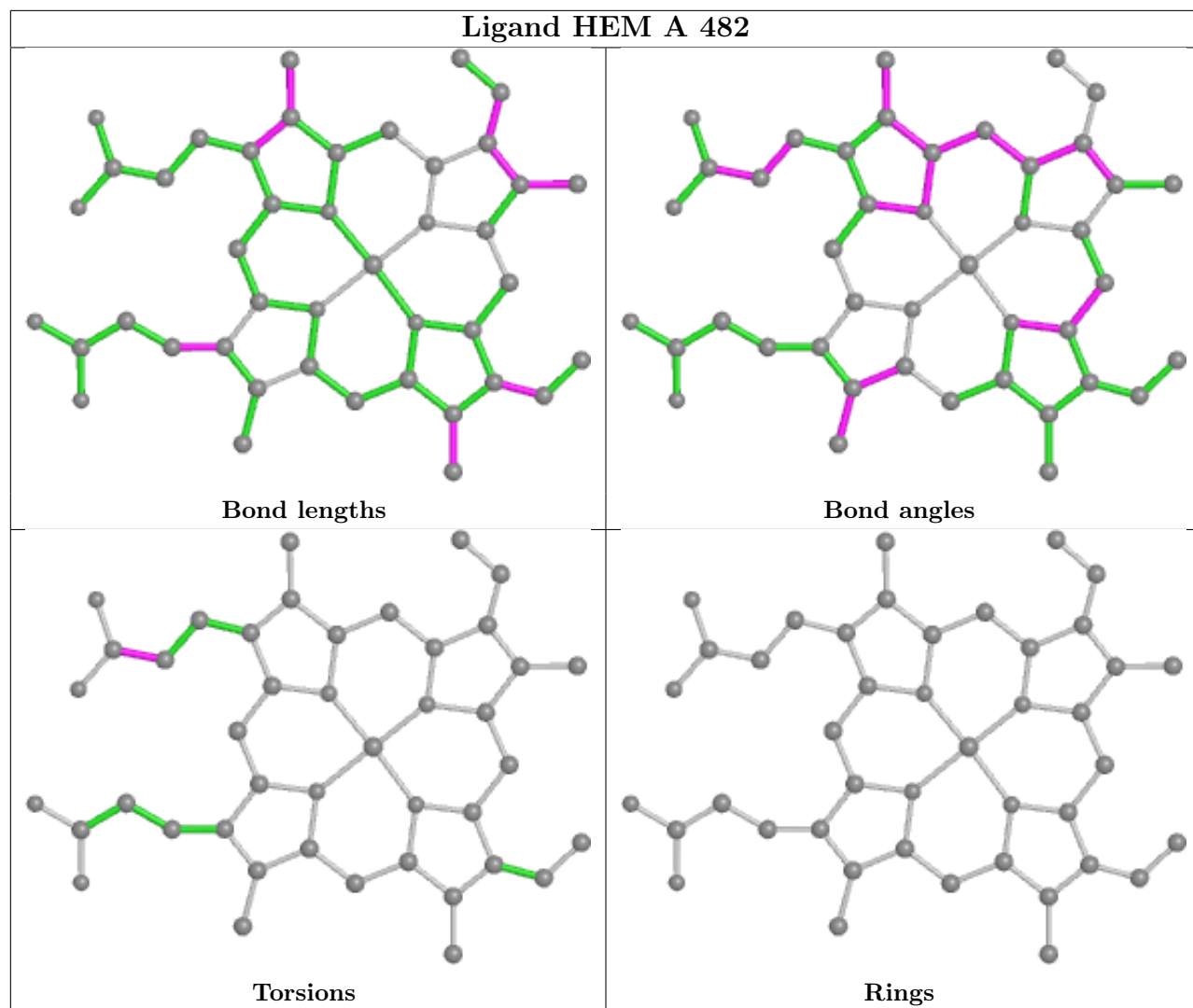

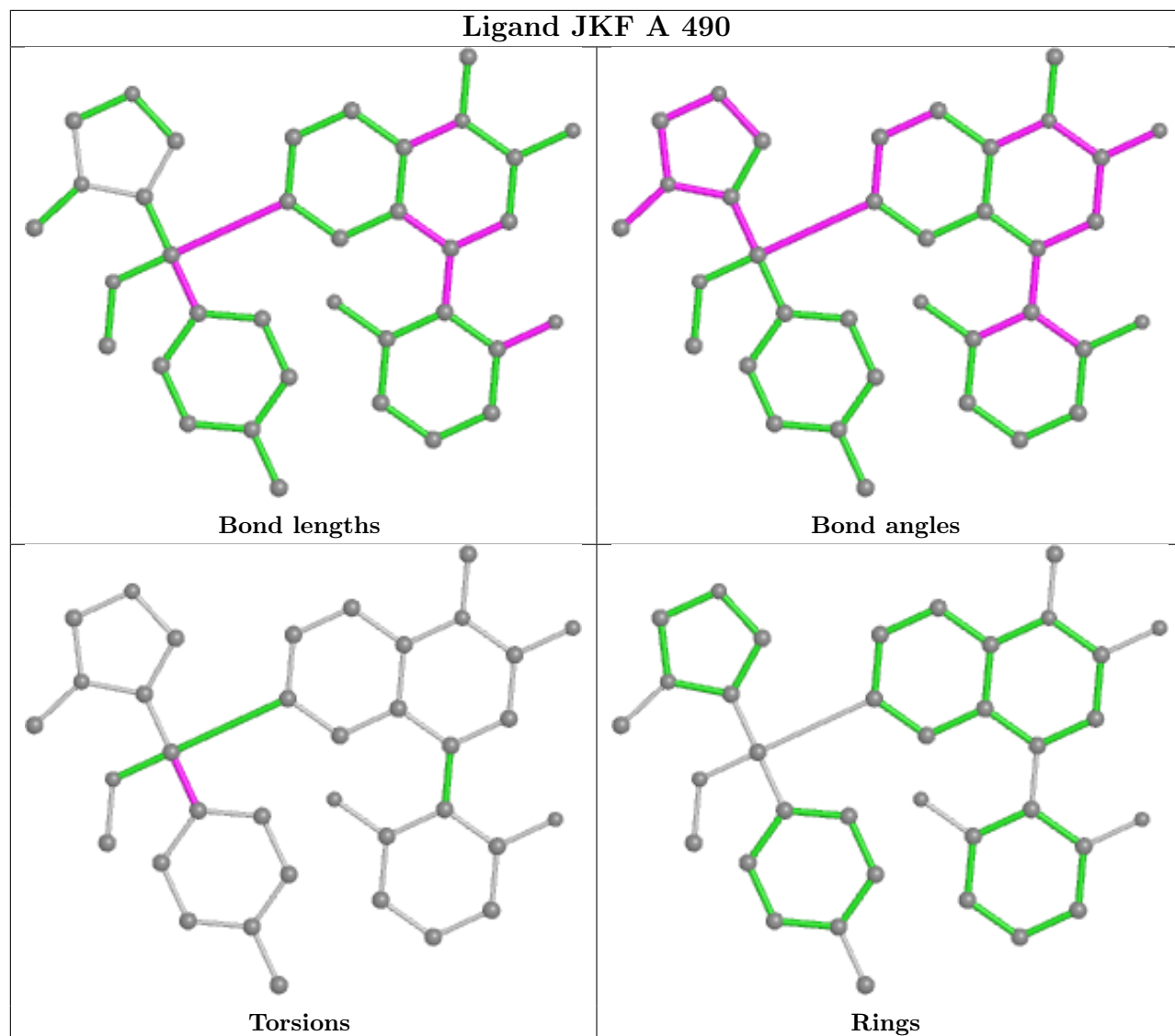

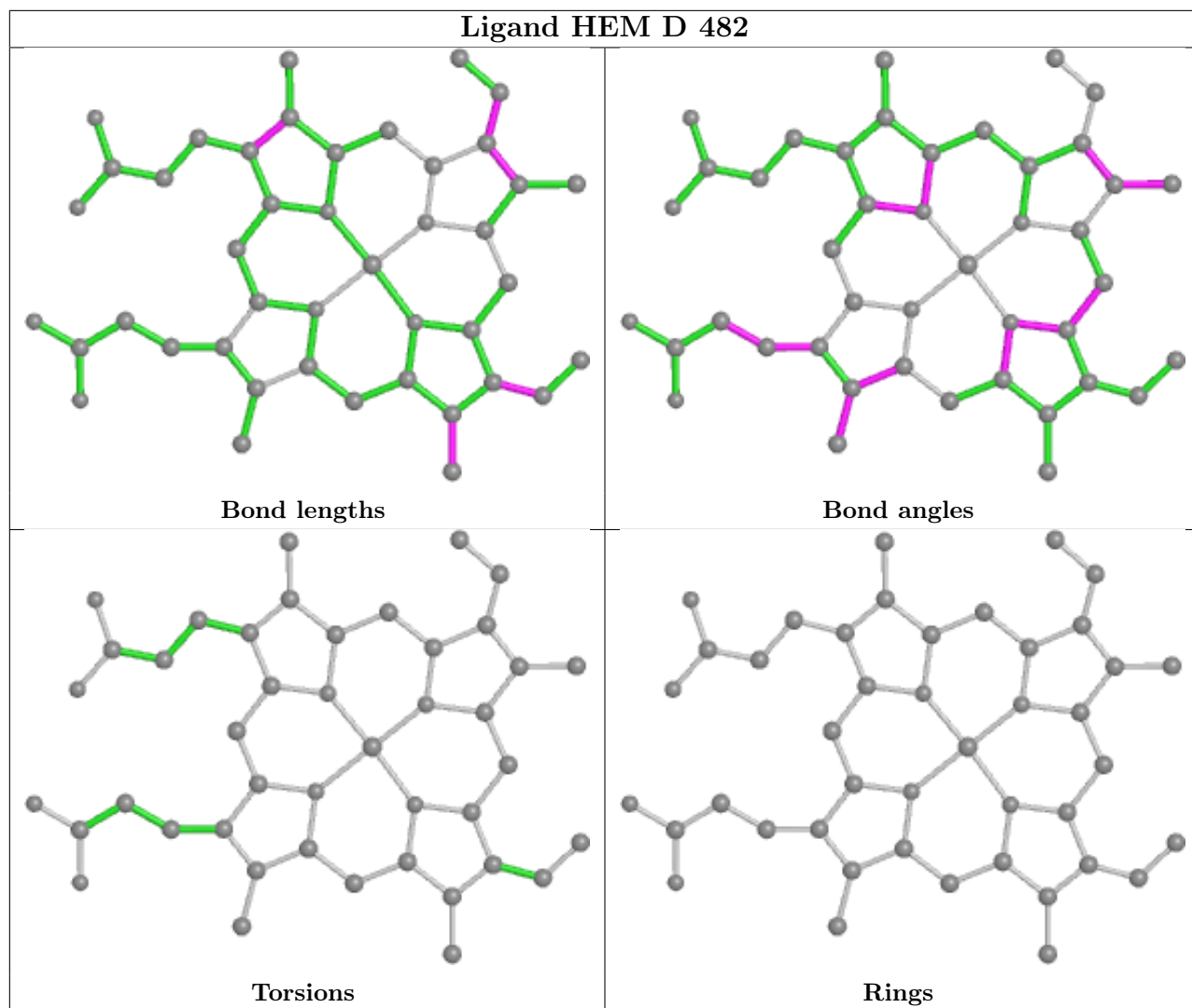

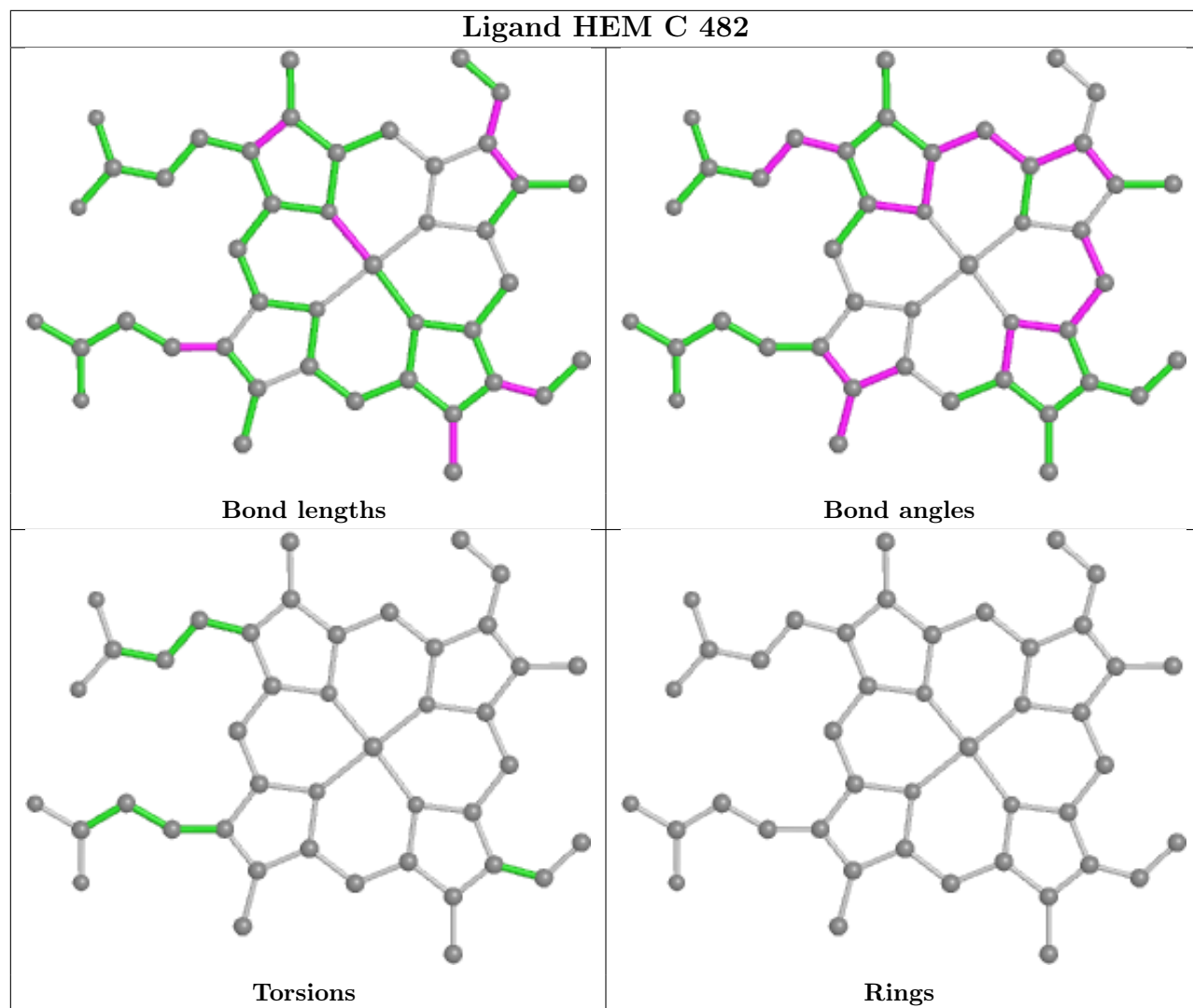

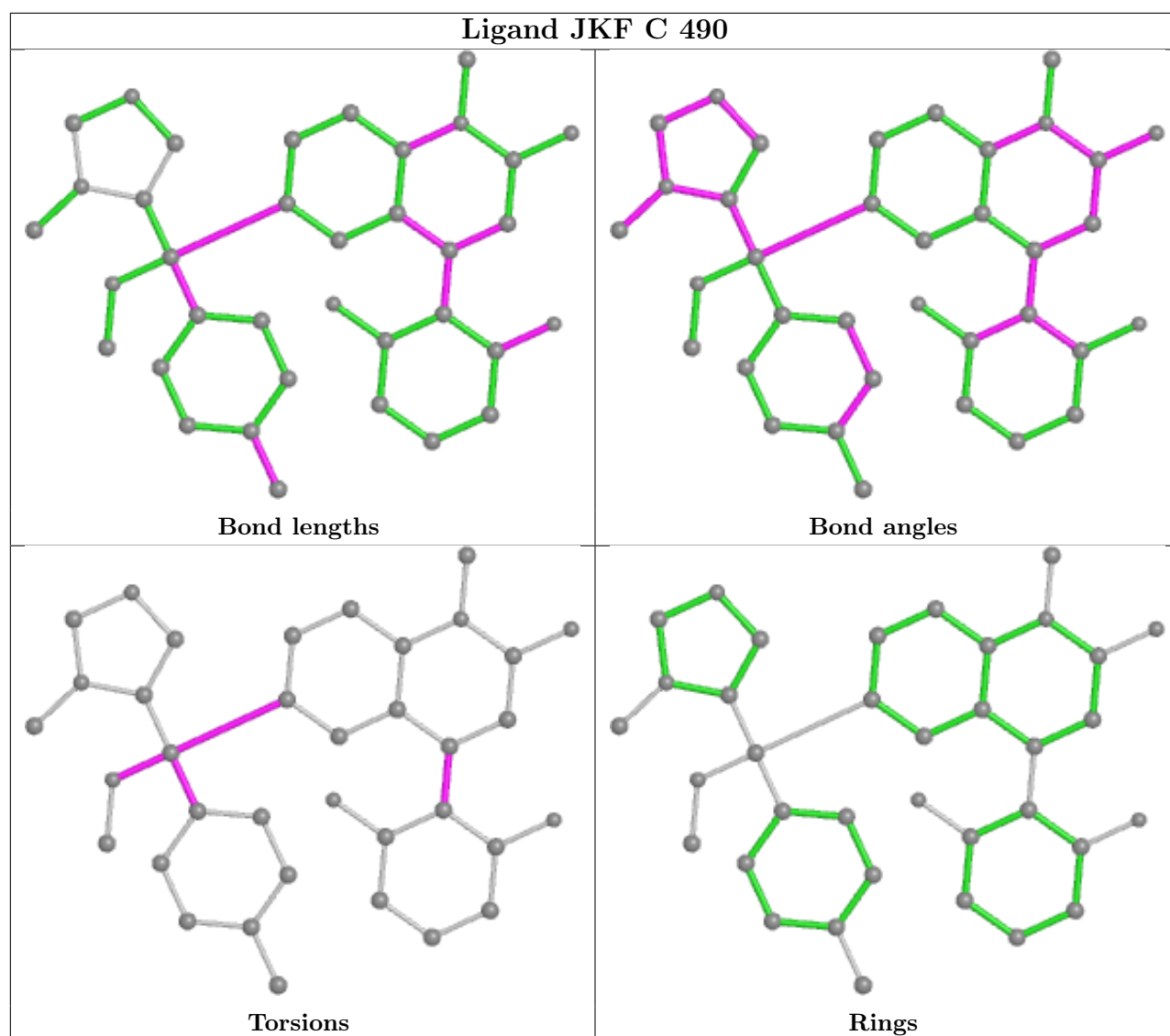

## 5.7 Other polymers [i](#)

There are no such residues in this entry.

## 5.8 Polymer linkage issues [i](#)

There are no chain breaks in this entry.

## 6 Fit of model and data

### 6.1 Protein, DNA and RNA chains

In the following table, the column labelled ‘#RSRZ > 2’ contains the number (and percentage) of RSRZ outliers, followed by percent RSRZ outliers for the chain as percentile scores relative to all X-ray entries and entries of similar resolution. The OWAB column contains the minimum, median, 95<sup>th</sup> percentile and maximum values of the occupancy-weighted average B-factor per residue. The column labelled ‘Q < 0.9’ lists the number of (and percentage) of residues with an average occupancy less than 0.9.

Mol	Chain	Analysed	<RSRZ>	#RSRZ>2	OWAB(Å <sup>2</sup> )	Q<0.9
1	A	450/454 (99%)	0.54	46 (10%) <b>6</b> <b>7</b>	33, 53, 75, 88	0
1	B	450/454 (99%)	0.50	35 (7%) <b>13</b> <b>14</b>	27, 47, 70, 95	0
1	C	450/454 (99%)	0.45	36 (8%) <b>12</b> <b>13</b>	33, 52, 73, 93	0
1	D	450/454 (99%)	0.26	20 (4%) <b>34</b> <b>37</b>	25, 41, 62, 85	0
All	All	1800/1816 (99%)	0.44	137 (7%) <b>13</b> <b>14</b>	25, 48, 72, 95	0

All (137) RSRZ outliers are listed below:

Mol	Chain	Res	Type	RSRZ
1	D	252	VAL	11.9
1	C	29	GLY	11.0
1	B	28	LYS	9.9
1	B	252	VAL	9.7
1	B	256	SER	9.1
1	C	28	LYS	8.1
1	D	28	LYS	7.5
1	C	256	SER	6.9
1	C	255	ASP	6.4
1	A	256	SER	6.0
1	B	255	ASP	6.0
1	B	251	GLU	6.0
1	B	257	SER	5.9
1	D	29	GLY	5.7
1	C	477	LYS	5.7
1	D	41	ILE	5.4
1	D	256	SER	5.3
1	B	253	ASN	5.0
1	C	257	SER	4.4
1	C	39	VAL	4.4
1	B	477	LYS	4.3

*Continued on next page...*



*Continued from previous page...*

<b>Mol</b>	<b>Chain</b>	<b>Res</b>	<b>Type</b>	<b>RSRZ</b>
1	A	329	GLN	4.3
1	B	474	ILE	4.2
1	D	254	LYS	4.1
1	A	328	ALA	4.1
1	B	40	PRO	4.1
1	A	271	ARG	4.0
1	C	271	ARG	4.0
1	D	477	LYS	3.9
1	A	159	ASP	3.9
1	A	190	LYS	3.8
1	A	257	SER	3.7
1	D	253	ASN	3.7
1	C	36	PRO	3.6
1	C	291	ALA	3.6
1	B	161	ASP	3.6
1	D	251	GLU	3.5
1	A	120	TYR	3.5
1	C	38	THR	3.4
1	B	29	GLY	3.4
1	D	257	SER	3.4
1	C	288	ALA	3.4
1	A	258	THR	3.4
1	A	195	ARG	3.4
1	C	373	VAL	3.3
1	A	192	LEU	3.3
1	C	41	ILE	3.2
1	A	447	LEU	3.2
1	A	155	ALA	3.1
1	B	359	LEU	3.1
1	C	121	PRO	3.1
1	C	93	ARG	3.1
1	A	310	PRO	3.0
1	D	255	ASP	3.0
1	C	295	THR	3.0
1	A	317	GLU	3.0
1	B	41	ILE	3.0
1	A	249	GLU	3.0
1	D	120	TYR	3.0
1	A	293	GLN	2.9
1	A	140	GLN	2.9
1	A	252	VAL	2.9
1	B	432	VAL	2.9

*Continued on next page...*

*Continued from previous page...*

<b>Mol</b>	<b>Chain</b>	<b>Res</b>	<b>Type</b>	<b>RSRZ</b>
1	B	300	THR	2.9
1	C	31	LEU	2.9
1	C	64	LYS	2.8
1	C	285	ILE	2.8
1	A	446	GLN	2.8
1	C	196	ARG	2.7
1	C	407	LYS	2.7
1	A	291	ALA	2.7
1	A	296	SER	2.7
1	A	46	ILE	2.7
1	B	321	LYS	2.6
1	A	188	LEU	2.6
1	B	162	GLU	2.6
1	B	61	ARG	2.6
1	C	435	ILE	2.5
1	B	159	ASP	2.5
1	A	295	THR	2.5
1	C	46	ILE	2.5
1	D	359	LEU	2.5
1	B	30	LYS	2.5
1	C	359	LEU	2.5
1	A	156	ALA	2.5
1	B	93	ARG	2.5
1	A	238	LYS	2.5
1	A	77	VAL	2.4
1	A	333	ASN	2.4
1	B	160	LYS	2.4
1	B	435	ILE	2.4
1	C	432	VAL	2.4
1	C	40	PRO	2.4
1	A	359	LEU	2.4
1	B	458	HIS	2.4
1	C	42	LEU	2.3
1	A	254	LYS	2.3
1	B	38	THR	2.3
1	D	287	ALA	2.3
1	D	220	LYS	2.3
1	C	195	ARG	2.3
1	A	95	GLU	2.3
1	A	477	LYS	2.3
1	B	350	ILE	2.3
1	B	371	SER	2.3

*Continued on next page...*

*Continued from previous page...*

Mol	Chain	Res	Type	RSRZ
1	C	372	TYR	2.3
1	A	196	ARG	2.3
1	B	39	VAL	2.3
1	A	40	PRO	2.3
1	C	296	SER	2.3
1	C	175	ILE	2.2
1	A	384	PRO	2.2
1	B	314	LYS	2.2
1	A	358	MET	2.1
1	B	254	LYS	2.1
1	D	50	LYS	2.1
1	A	62	GLN	2.1
1	A	292	GLY	2.1
1	D	291	ALA	2.1
1	A	290	PHE	2.1
1	C	270	TYR	2.1
1	B	295	THR	2.1
1	D	191	ARG	2.1
1	D	195	ARG	2.1
1	A	298	ILE	2.1
1	B	303	SER	2.1
1	A	314	LYS	2.1
1	C	62	GLN	2.0
1	C	329	GLN	2.0
1	C	274	THR	2.0
1	A	191	ARG	2.0
1	D	329	GLN	2.0
1	A	356	LEU	2.0
1	A	432	VAL	2.0
1	A	41	ILE	2.0
1	B	357	LEU	2.0
1	B	163	GLY	2.0

## 6.2 Non-standard residues in protein, DNA, RNA chains [i](#)

There are no non-standard protein/DNA/RNA residues in this entry.

## 6.3 Carbohydrates [i](#)

There are no monosaccharides in this entry.

## 6.4 Ligands

In the following table, the Atoms column lists the number of modelled atoms in the group and the number defined in the chemical component dictionary. The B-factors column lists the minimum, median, 95<sup>th</sup> percentile and maximum values of B factors of atoms in the group. The column labelled 'Q<0.9' lists the number of atoms with occupancy less than 0.9.

Mol	Type	Chain	Res	Atoms	RSCC	RSR	B-factors( $\text{\AA}^2$ )	Q<0.9
3	JKF	C	490	36/36	0.92	0.21	38,49,58,64	0
3	JKF	B	490	36/36	0.96	0.18	31,42,57,65	0
3	JKF	A	490	36/36	0.96	0.17	33,41,60,66	0
3	JKF	D	490	36/36	0.96	0.24	21,39,56,66	0
2	HEM	A	482	43/43	0.97	0.20	29,32,39,45	0
2	HEM	C	482	43/43	0.97	0.20	35,40,48,55	0
2	HEM	B	482	43/43	0.98	0.18	23,31,37,41	0
2	HEM	D	482	43/43	0.98	0.19	23,27,38,43	0

The following is a graphical depiction of the model fit to experimental electron density of all instances of the Ligand of Interest. In addition, ligands with molecular weight > 250 and outliers as shown on the geometry validation Tables will also be included. Each fit is shown from different orientation to approximate a three-dimensional view.

**Electron density around JKF C 490:**

$2mF_o-DF_c$  (at 0.7 rmsd) in gray  
 $mF_o-DF_c$  (at 3 rmsd) in purple (negative)  
and green (positive)

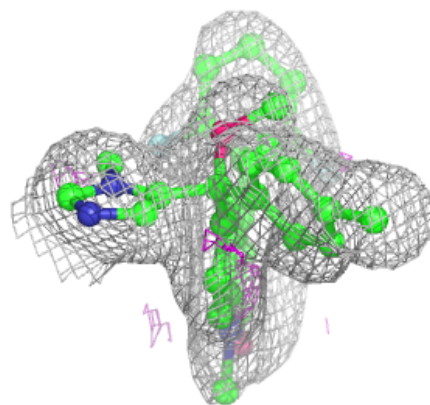
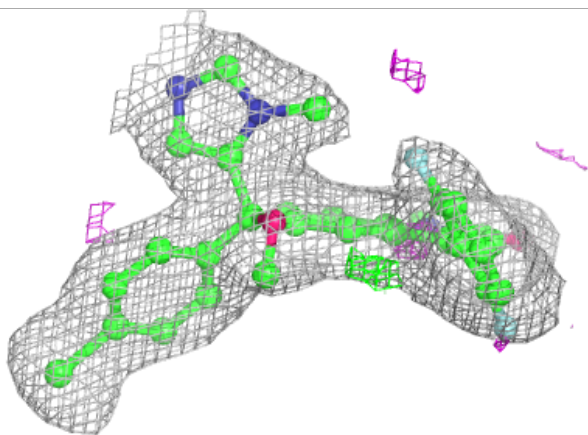
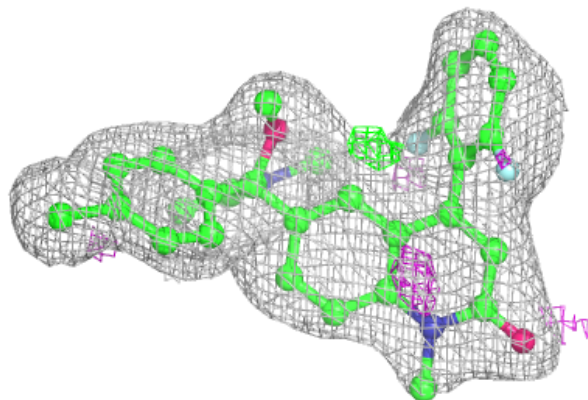

**Electron density around JKF B 490:**

$2mF_o-DF_c$  (at 0.7 rmsd) in gray  
 $mF_o-DF_c$  (at 3 rmsd) in purple (negative)  
and green (positive)

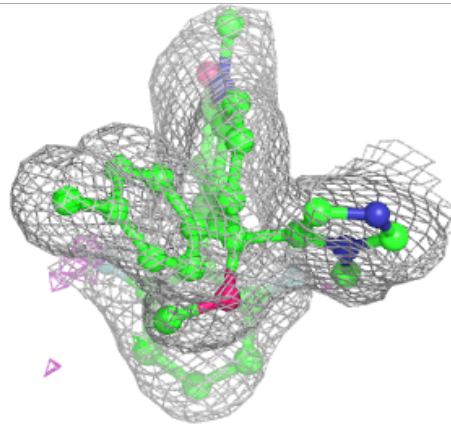
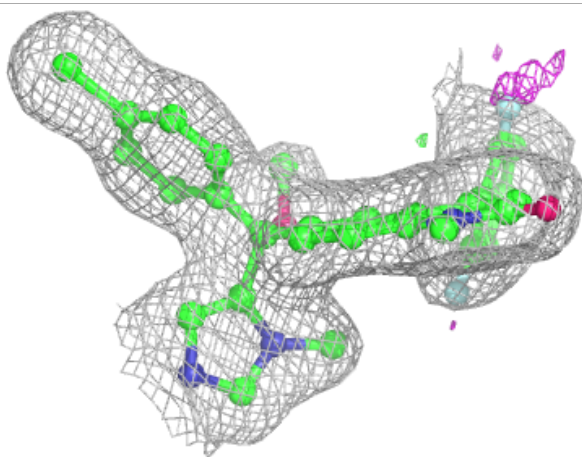
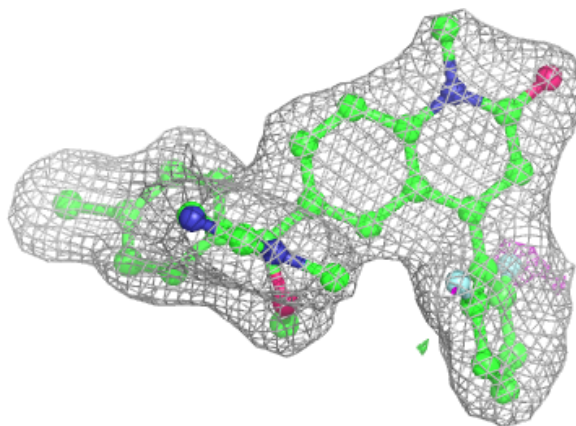

**Electron density around JKF A 490:**

$2mF_o-DF_c$  (at 0.7 rmsd) in gray  
 $mF_o-DF_c$  (at 3 rmsd) in purple (negative)  
and green (positive)

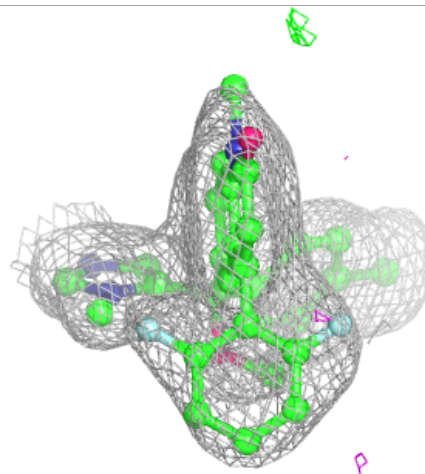
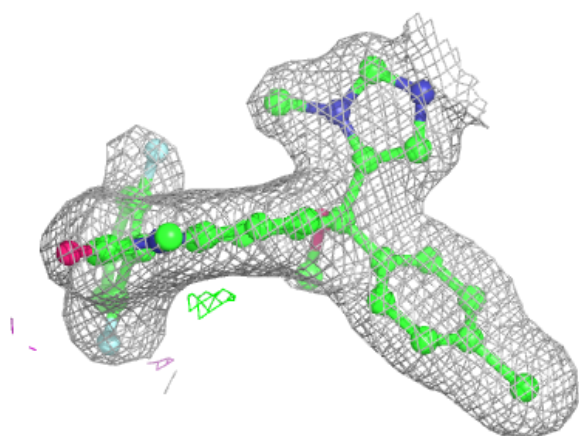
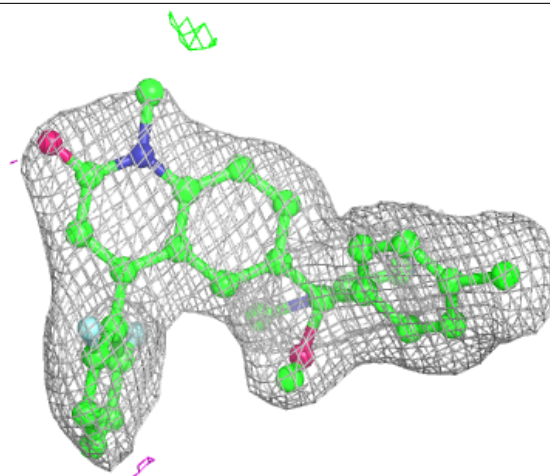

**Electron density around JKF D 490:**

$2mF_o-DF_c$  (at 0.7 rmsd) in gray  
 $mF_o-DF_c$  (at 3 rmsd) in purple (negative)  
and green (positive)

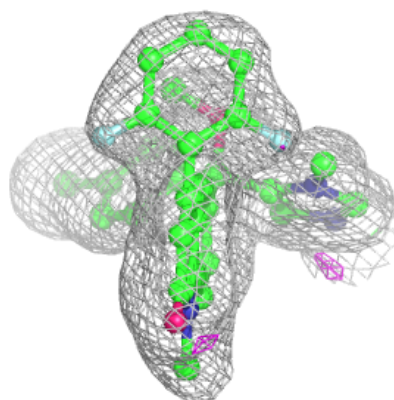
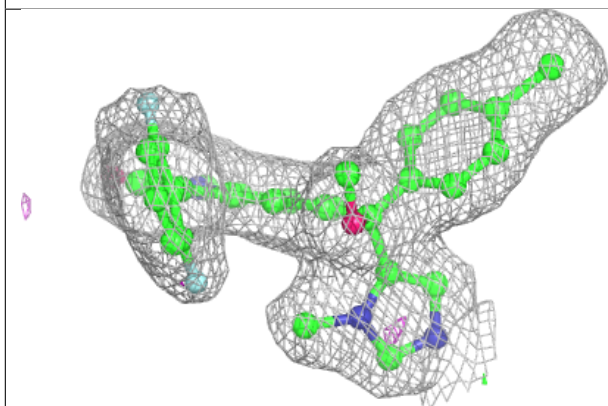
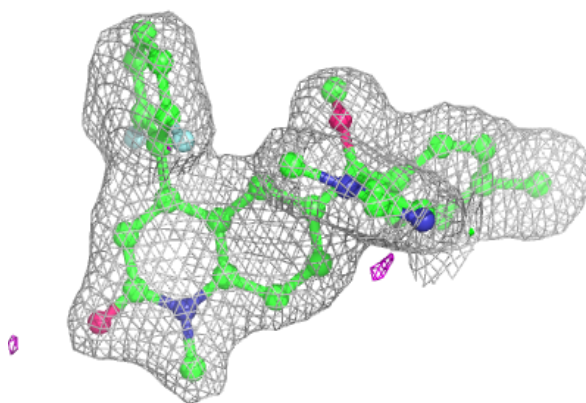



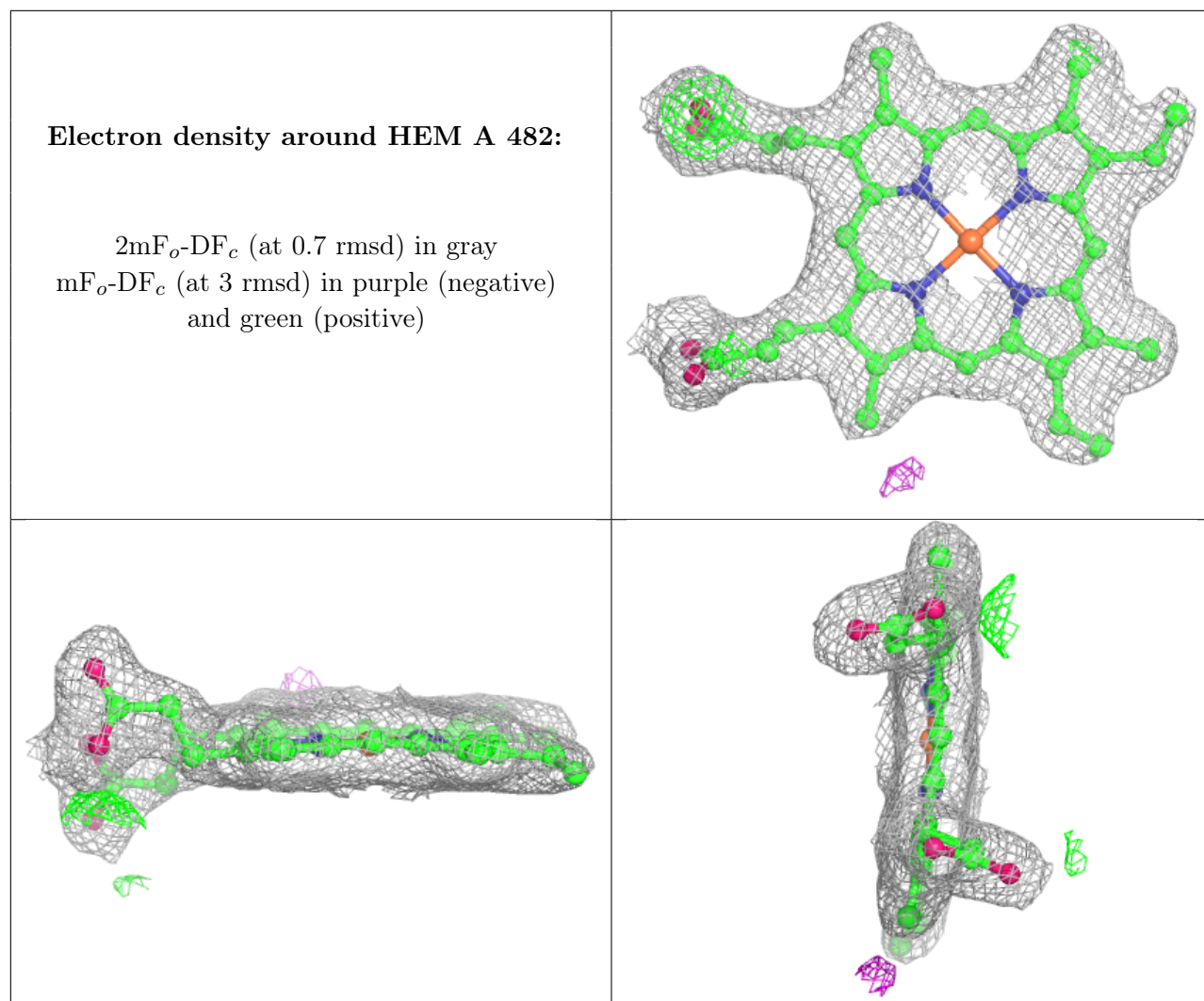

**Electron density around HEM C 482:**

$2mF_o-DF_c$  (at 0.7 rmsd) in gray  
 $mF_o-DF_c$  (at 3 rmsd) in purple (negative)  
and green (positive)

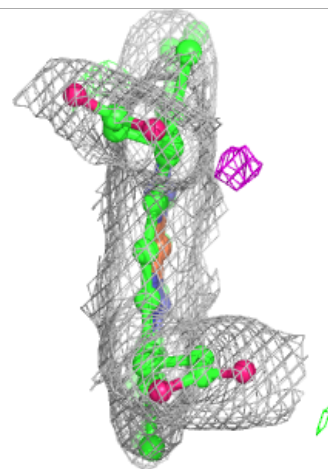
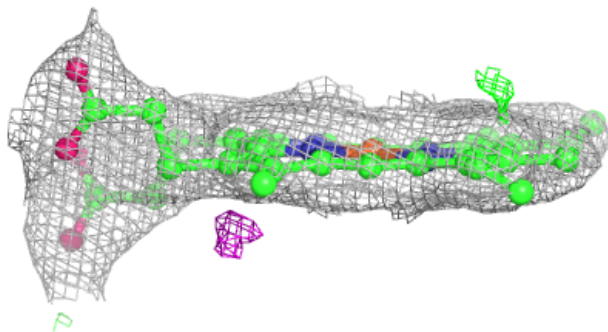
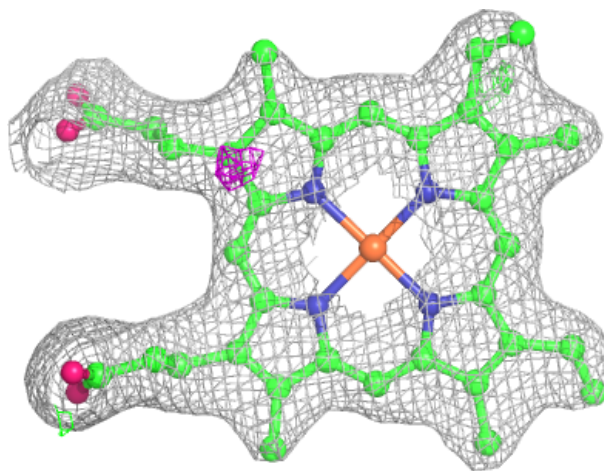

**Electron density around HEM B 482:**

$2mF_o-DF_c$  (at 0.7 rmsd) in gray  
 $mF_o-DF_c$  (at 3 rmsd) in purple (negative)  
and green (positive)

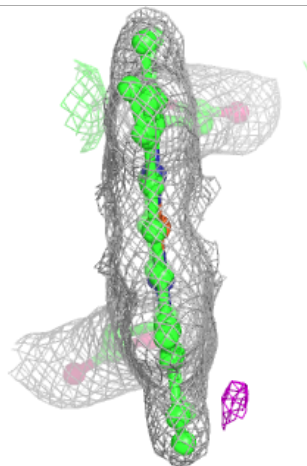
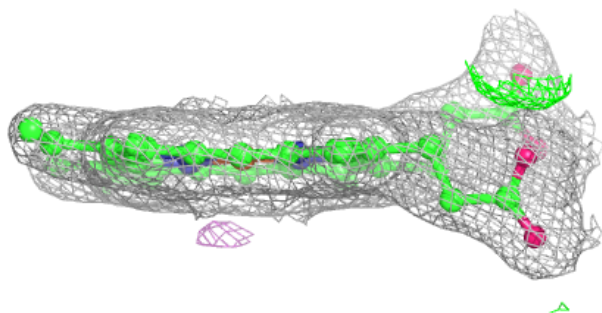
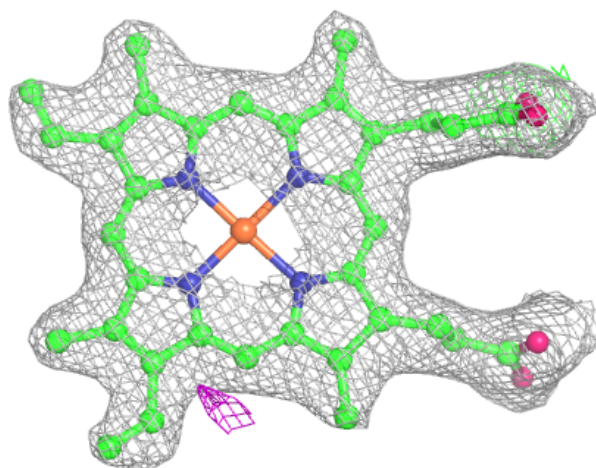

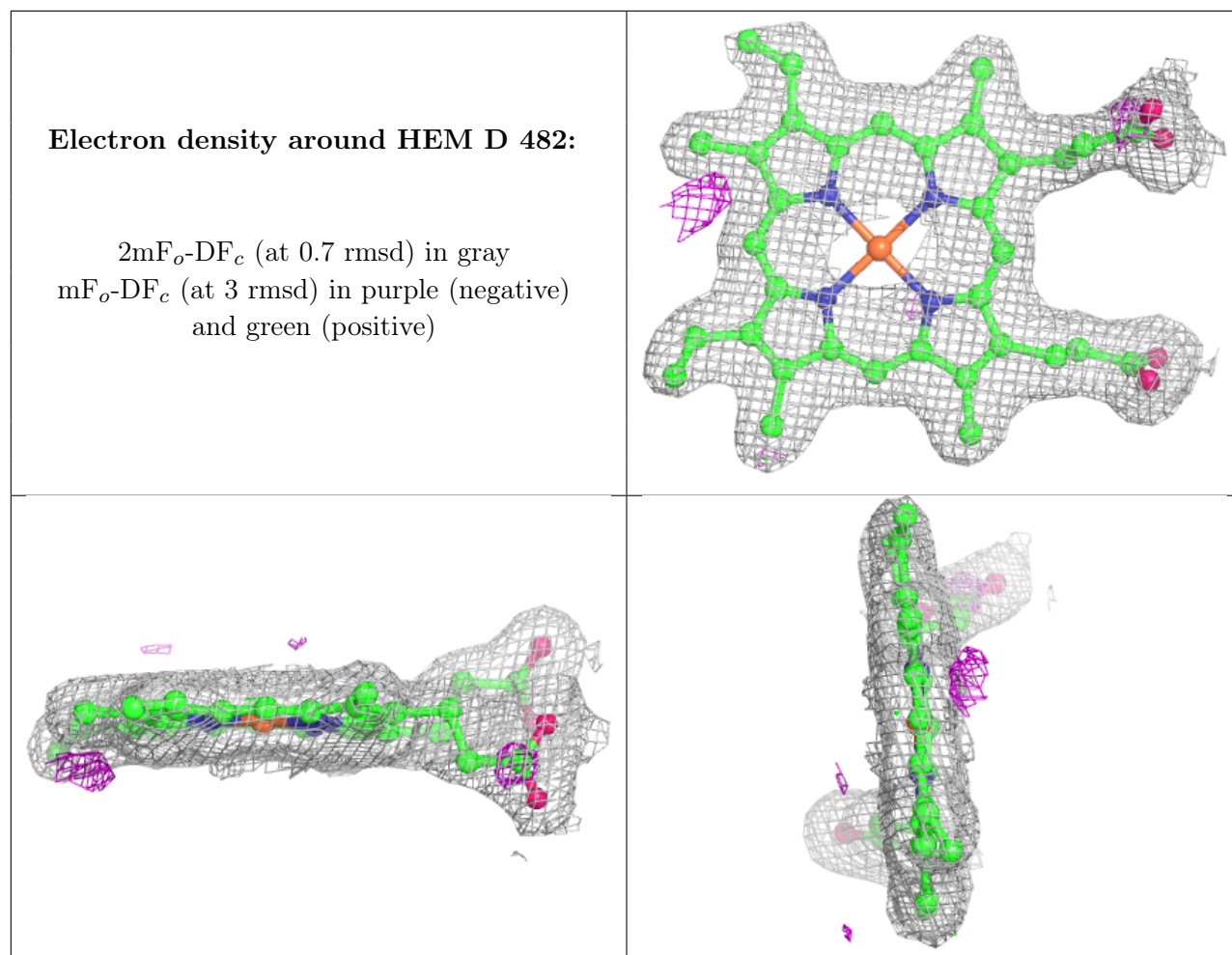

## 6.5 Other polymers [\(i\)](#)

There are no such residues in this entry.