



wwPDB X-ray Structure Validation Summary Report ⓘ

Oct 3, 2021 – 01:10 PM EDT

PDB ID : 3HTE
Title : Crystal structure of nucleotide-free hexameric ClpX
Authors : Glynn, S.E.; Martin, A.; Baker, T.A.; Sauer, R.T.
Deposited on : 2009-06-11
Resolution : 4.03 Å(reported)

This is a wwPDB X-ray Structure Validation Summary Report for a publicly released PDB entry.

We welcome your comments at validation@mail.wwpdb.org

A user guide is available at

<https://www.wwpdb.org/validation/2017/XrayValidationReportHelp>

with specific help available everywhere you see the ⓘ symbol.

The following versions of software and data (see [references ⓘ](#)) were used in the production of this report:

MolProbity : 4.02b-467
Mogul : 1.8.5 (274361), CSD as541be (2020)
Xtriage (Phenix) : 1.13
EDS : 2.23.2
Percentile statistics : 20191225.v01 (using entries in the PDB archive December 25th 2019)
Refmac : 5.8.0158
CCP4 : 7.0.044 (Gargrove)
Ideal geometry (proteins) : Engh & Huber (2001)
Ideal geometry (DNA, RNA) : Parkinson et al. (1996)
Validation Pipeline (wwPDB-VP) : 2.23.2

1 Overall quality at a glance i

The following experimental techniques were used to determine the structure:

X-RAY DIFFRACTION

The reported resolution of this entry is 4.03 Å.

Percentile scores (ranging between 0-100) for global validation metrics of the entry are shown in the following graphic. The table shows the number of entries on which the scores are based.

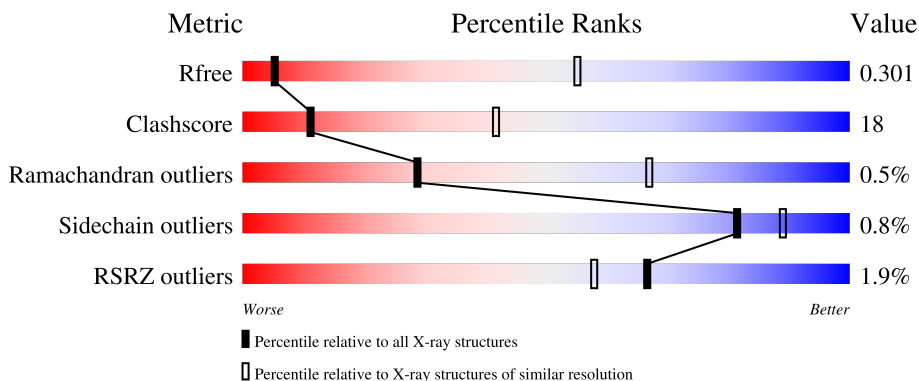

Metric	Whole archive (#Entries)	Similar resolution (#Entries, resolution range(Å))
R_{free}	130704	1098 (4.34-3.70)
Clashscore	141614	1159 (4.34-3.70)
Ramachandran outliers	138981	1118 (4.34-3.70)
Sidechain outliers	138945	1108 (4.34-3.70)
RSRZ outliers	127900	1034 (4.38-3.66)

The table below summarises the geometric issues observed across the polymeric chains and their fit to the electron density. The red, orange, yellow and green segments of the lower bar indicate the fraction of residues that contain outliers for ≥ 3 , 2, 1 and 0 types of geometric quality criteria respectively. A grey segment represents the fraction of residues that are not modelled. The numeric value for each fraction is indicated below the corresponding segment, with a dot representing fractions $\leq 5\%$. The upper red bar (where present) indicates the fraction of residues that have poor fit to the electron density. The numeric value is given above the bar.

Mol	Chain	Length	Quality of chain
1	A	363	
1	B	363	
1	C	363	
1	D	363	
1	E	363	

Continued on next page...

Continued from previous page...

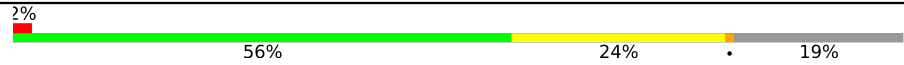
Mol	Chain	Length	Quality of chain
1	F	363	 <p>A horizontal bar chart representing the quality of chain. The bar is divided into four segments: a small red segment (2%), a large green segment (56%), a yellow segment (24%), and a grey segment (19%).</p>

2 Entry composition

There are 2 unique types of molecules in this entry. The entry contains 12777 atoms, of which 0 are hydrogens and 0 are deuteriums.

In the tables below, the ZeroOcc column contains the number of atoms modelled with zero occupancy, the AltConf column contains the number of residues with at least one atom in alternate conformation and the Trace column contains the number of residues modelled with at most 2 atoms.

- Molecule 1 is a protein called ATP-dependent Clp protease ATP-binding subunit clpX.

Mol	Chain	Residues	Atoms					ZeroOcc	AltConf	Trace
			Total	C	N	O	S			
1	A	317	Total 2265	C 1437	N 370	O 452	S 6	0	0	0
1	B	309	Total 2194	C 1388	N 361	O 439	S 6	0	0	0
1	C	283	Total 2003	C 1279	N 322	O 396	S 6	0	0	0
1	D	301	Total 2087	C 1319	N 339	O 423	S 6	0	0	0
1	E	302	Total 2113	C 1343	N 345	O 419	S 6	0	0	0
1	F	293	Total 2085	C 1333	N 336	O 411	S 5	0	0	0

There are 6 discrepancies between the modelled and reference sequences:

Chain	Residue	Modelled	Actual	Comment	Reference
A	185	GLN	GLU	engineered mutation	UNP P0A6H1
B	185	GLN	GLU	engineered mutation	UNP P0A6H1
C	185	GLN	GLU	engineered mutation	UNP P0A6H1
D	185	GLN	GLU	engineered mutation	UNP P0A6H1
E	185	GLN	GLU	engineered mutation	UNP P0A6H1
F	185	GLN	GLU	engineered mutation	UNP P0A6H1

- Molecule 2 is SULFATE ION (three-letter code: SO4) (formula: O₄S).



Mol	Chain	Residues	Atoms			ZeroOcc	AltConf
2	A	1	Total	O	S	0	0
			5	4	1		
2	B	1	Total	O	S	0	0
			5	4	1		
2	C	1	Total	O	S	0	0
			5	4	1		
2	D	1	Total	O	S	0	0
			5	4	1		
2	E	1	Total	O	S	0	0
			5	4	1		
2	F	1	Total	O	S	0	0
			5	4	1		

3 Residue-property plots

These plots are drawn for all protein, RNA, DNA and oligosaccharide chains in the entry. The first graphic for a chain summarises the proportions of the various outlier classes displayed in the second graphic. The second graphic shows the sequence view annotated by issues in geometry and electron density. Residues are color-coded according to the number of geometric quality criteria for which they contain at least one outlier: green = 0, yellow = 1, orange = 2 and red = 3 or more. A red dot above a residue indicates a poor fit to the electron density ($RSRZ > 2$). Stretches of 2 or more consecutive residues without any outlier are shown as a green connector. Residues present in the sample, but not in the model, are shown in grey.

- Molecule 1: ATP-dependent Clp protease ATP-binding subunit clpX

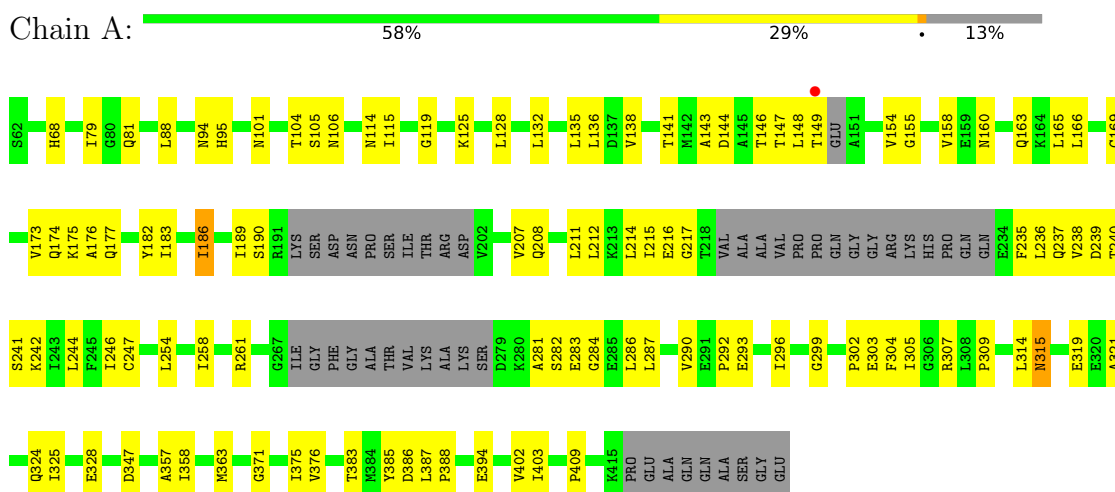

- Molecule 1: ATP-dependent Clp protease ATP-binding subunit clpX

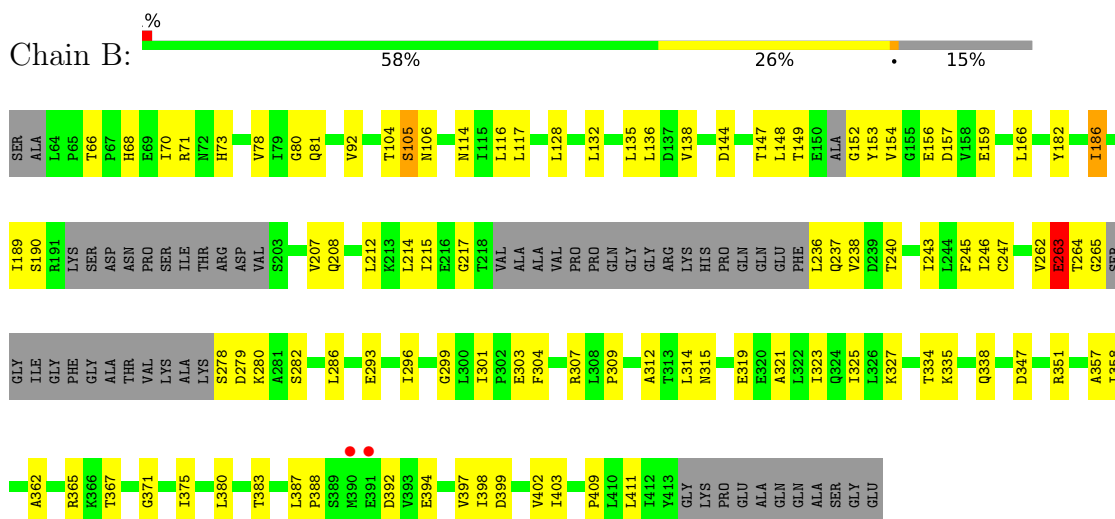

- Molecule 1: ATP-dependent Clp protease ATP-binding subunit clpX



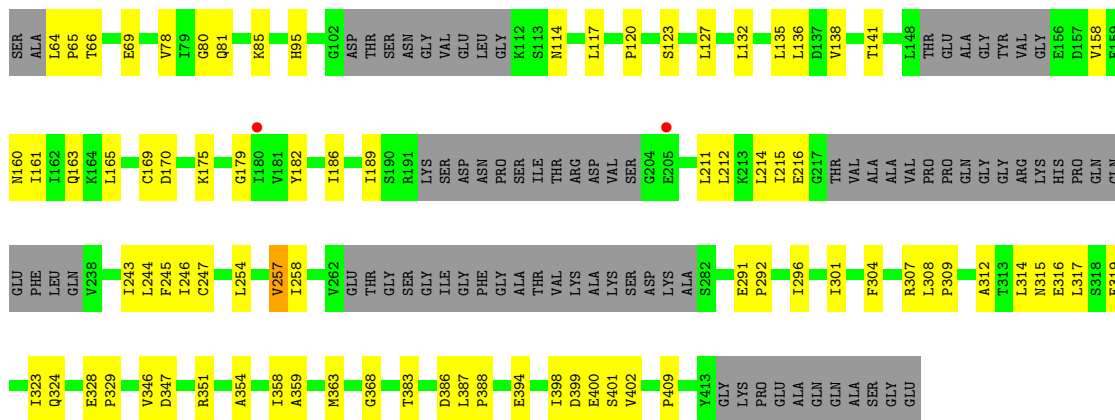

- Molecule 1: ATP-dependent Clp protease ATP-binding subunit clpX

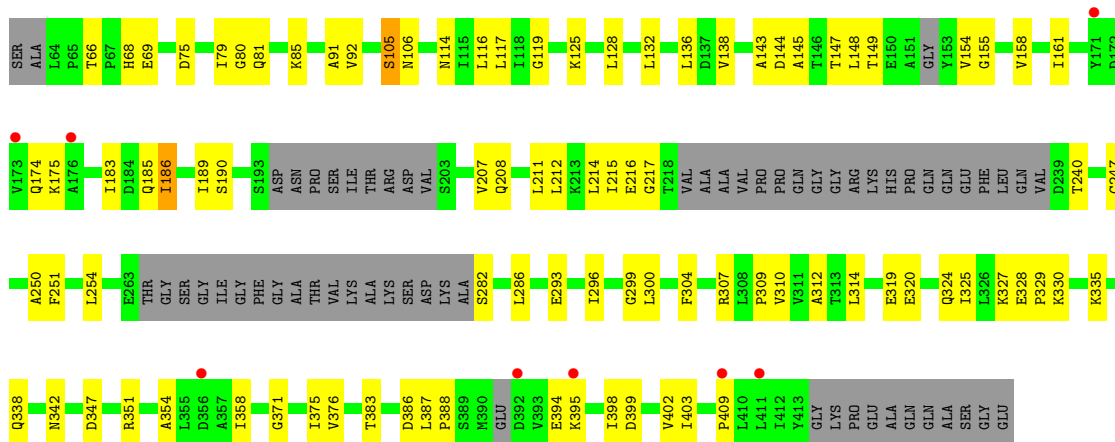

- Molecule 1: ATP-dependent Clp protease ATP-binding subunit clpX

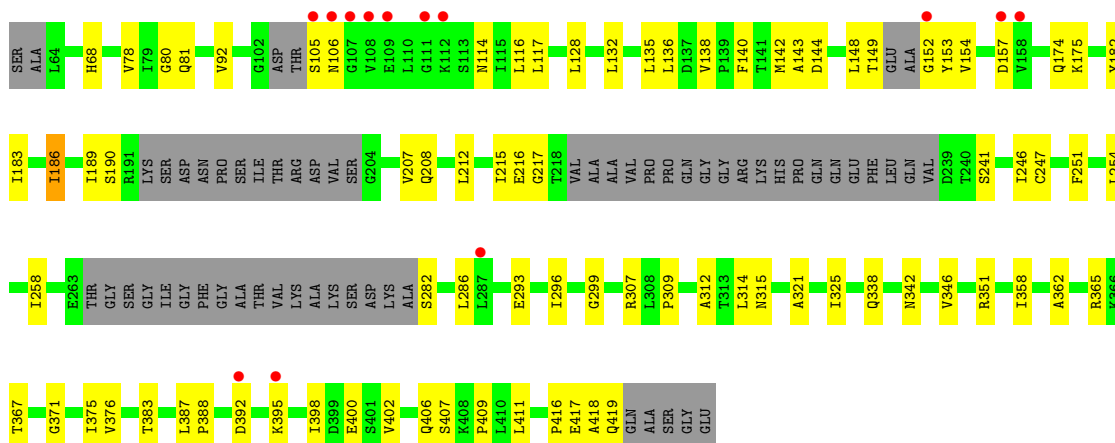

- Molecule 1: ATP-dependent Clp protease ATP-binding subunit clpX

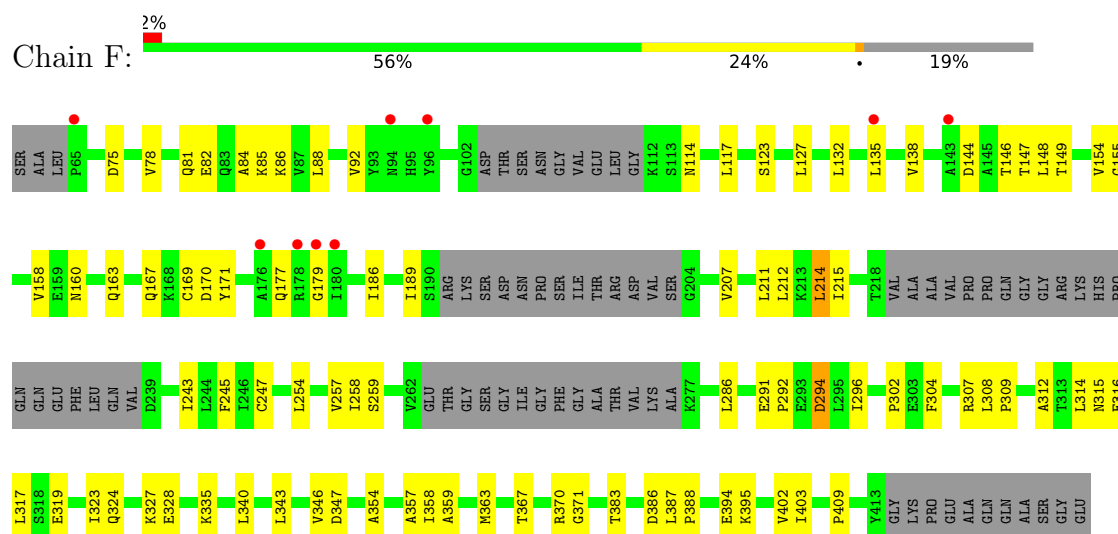

4 Data and refinement statistics

Property	Value	Source
Space group	P 21 21 21	Depositor
Cell constants a, b, c, α , β , γ	63.33Å 199.92Å 202.49Å 90.00° 90.00° 90.00°	Depositor
Resolution (Å)	49.07 – 4.03 49.07 – 4.03	Depositor EDS
% Data completeness (in resolution range)	98.5 (49.07-4.03) 98.5 (49.07-4.03)	Depositor EDS
R_{merge}	0.05	Depositor
R_{sym}	(Not available)	Depositor
$\langle I/\sigma(I) \rangle$ ¹	3.32 (at 4.00Å)	Xtrriage
Refinement program	PHENIX	Depositor
R, R_{free}	0.278 , 0.313 0.265 , 0.301	Depositor DCC
R_{free} test set	1128 reflections (5.17%)	wwPDB-VP
Wilson B-factor (Å ²)	177.8	Xtrriage
Anisotropy	0.612	Xtrriage
Bulk solvent k_{sol} (e/Å ³), B_{sol} (Å ²)	0.30 , 240.8	EDS
L-test for twinning ²	$\langle L \rangle = 0.50$, $\langle L^2 \rangle = 0.33$	Xtrriage
Estimated twinning fraction	0.010 for -h,l,k	Xtrriage
F_o, F_c correlation	0.93	EDS
Total number of atoms	12777	wwPDB-VP
Average B, all atoms (Å ²)	258.0	wwPDB-VP

Xtrriage's analysis on translational NCS is as follows: *The largest off-origin peak in the Patterson function is 3.26% of the height of the origin peak. No significant pseudotranslation is detected.*

¹Intensities estimated from amplitudes.

²Theoretical values of $\langle |L| \rangle$, $\langle L^2 \rangle$ for acentric reflections are 0.5, 0.333 respectively for untwinned datasets, and 0.375, 0.2 for perfectly twinned datasets.

5 Model quality

5.1 Standard geometry

Bond lengths and bond angles in the following residue types are not validated in this section: SO4

The Z score for a bond length (or angle) is the number of standard deviations the observed value is removed from the expected value. A bond length (or angle) with $|Z| > 5$ is considered an outlier worth inspection. RMSZ is the root-mean-square of all Z scores of the bond lengths (or angles).

Mol	Chain	Bond lengths		Bond angles	
		RMSZ	# Z >5	RMSZ	# Z >5
1	A	0.22	0/2290	0.39	0/3122
1	B	0.20	0/2216	0.38	0/3023
1	C	0.21	0/2023	0.38	0/2765
1	D	0.20	0/2103	0.37	0/2871
1	E	0.21	0/2134	0.38	0/2913
1	F	0.22	0/2108	0.40	0/2878
All	All	0.21	0/12874	0.38	0/17572

There are no bond length outliers.

There are no bond angle outliers.

There are no chirality outliers.

There are no planarity outliers.

5.2 Too-close contacts

In the following table, the Non-H and H(model) columns list the number of non-hydrogen atoms and hydrogen atoms in the chain respectively. The H(added) column lists the number of hydrogen atoms added and optimized by MolProbity. The Clashes column lists the number of clashes within the asymmetric unit, whereas Symm-Clashes lists symmetry-related clashes.

Mol	Chain	Non-H	H(model)	H(added)	Clashes	Symm-Clashes
1	A	2265	0	2151	90	0
1	B	2194	0	2077	76	0
1	C	2003	0	1892	61	0
1	D	2087	0	1937	67	0
1	E	2113	0	1986	80	0
1	F	2085	0	1990	85	0
2	A	5	0	0	1	0

Continued on next page...

Continued from previous page...

Mol	Chain	Non-H	H(model)	H(added)	Clashes	Symm-Clashes
2	B	5	0	0	0	0
2	C	5	0	0	0	0
2	D	5	0	0	1	0
2	E	5	0	0	0	0
2	F	5	0	0	0	0
All	All	12777	0	12033	445	0

The all-atom clashscore is defined as the number of clashes found per 1000 atoms (including hydrogen atoms). The all-atom clashscore for this structure is 18.

The worst 5 of 445 close contacts within the same asymmetric unit are listed below, sorted by their clash magnitude.

Atom-1	Atom-2	Interatomic distance (Å)	Clash overlap (Å)
1:A:235:PHE:CE2	1:A:237:GLN:HA	1.69	1.27
1:E:416:PRO:CB	1:E:418:ALA:H	1.50	1.22
1:E:416:PRO:HB3	1:E:418:ALA:N	1.54	1.17
1:E:416:PRO:HB3	1:E:418:ALA:H	0.95	1.10
1:A:235:PHE:CE2	1:A:237:GLN:CA	2.35	1.08

There are no symmetry-related clashes.

5.3 Torsion angles [i](#)

5.3.1 Protein backbone [i](#)

In the following table, the Percentiles column shows the percent Ramachandran outliers of the chain as a percentile score with respect to all X-ray entries followed by that with respect to entries of similar resolution.

The Analysed column shows the number of residues for which the backbone conformation was analysed, and the total number of residues.

Mol	Chain	Analysed	Favoured	Allowed	Outliers	Percentiles
1	A	307/363 (85%)	289 (94%)	15 (5%)	3 (1%)	15 53
1	B	299/363 (82%)	285 (95%)	12 (4%)	2 (1%)	22 61
1	C	271/363 (75%)	262 (97%)	8 (3%)	1 (0%)	34 71
1	D	289/363 (80%)	278 (96%)	9 (3%)	2 (1%)	22 61
1	E	290/363 (80%)	279 (96%)	11 (4%)	0	100 100

Continued on next page...

Continued from previous page...

Mol	Chain	Analysed	Favoured	Allowed	Outliers	Percentiles	
1	F	283/363 (78%)	273 (96%)	10 (4%)	0	100	100
All	All	1739/2178 (80%)	1666 (96%)	65 (4%)	8 (0%)	29	67

5 of 8 Ramachandran outliers are listed below:

Mol	Chain	Res	Type
1	A	282	SER
1	B	263	GLU
1	D	154	VAL
1	A	241	SER
1	C	216	GLU

5.3.2 Protein sidechains [i](#)

In the following table, the Percentiles column shows the percent sidechain outliers of the chain as a percentile score with respect to all X-ray entries followed by that with respect to entries of similar resolution.

The Analysed column shows the number of residues for which the sidechain conformation was analysed, and the total number of residues.

Mol	Chain	Analysed	Rotameric	Outliers	Percentiles	
1	A	222/299 (74%)	220 (99%)	2 (1%)	78	88
1	B	214/299 (72%)	212 (99%)	2 (1%)	78	88
1	C	193/299 (64%)	192 (100%)	1 (0%)	88	93
1	D	196/299 (66%)	195 (100%)	1 (0%)	88	93
1	E	200/299 (67%)	199 (100%)	1 (0%)	88	93
1	F	202/299 (68%)	199 (98%)	3 (2%)	65	80
All	All	1227/1794 (68%)	1217 (99%)	10 (1%)	81	89

5 of 10 residues with a non-rotameric sidechain are listed below:

Mol	Chain	Res	Type
1	F	214	LEU
1	F	257	VAL
1	F	294	ASP
1	B	263	GLU
1	C	257	VAL

Sometimes sidechains can be flipped to improve hydrogen bonding and reduce clashes. All (4) such sidechains are listed below:

Mol	Chain	Res	Type
1	A	101	ASN
1	C	81	GLN
1	F	81	GLN
1	F	114	ASN

5.3.3 RNA [i](#)

There are no RNA molecules in this entry.

5.4 Non-standard residues in protein, DNA, RNA chains [i](#)

There are no non-standard protein/DNA/RNA residues in this entry.

5.5 Carbohydrates [i](#)

There are no monosaccharides in this entry.

5.6 Ligand geometry [i](#)

6 ligands are modelled in this entry.

In the following table, the Counts columns list the number of bonds (or angles) for which Mogul statistics could be retrieved, the number of bonds (or angles) that are observed in the model and the number of bonds (or angles) that are defined in the Chemical Component Dictionary. The Link column lists molecule types, if any, to which the group is linked. The Z score for a bond length (or angle) is the number of standard deviations the observed value is removed from the expected value. A bond length (or angle) with $|Z| > 2$ is considered an outlier worth inspection. RMSZ is the root-mean-square of all Z scores of the bond lengths (or angles).

Mol	Type	Chain	Res	Link	Bond lengths			Bond angles		
					Counts	RMSZ	$\# Z > 2$	Counts	RMSZ	$\# Z > 2$
2	SO4	D	500	-	4,4,4	0.10	0	6,6,6	0.15	0
2	SO4	B	500	-	4,4,4	0.13	0	6,6,6	0.13	0
2	SO4	C	500	-	4,4,4	0.13	0	6,6,6	0.04	0
2	SO4	E	500	-	4,4,4	0.11	0	6,6,6	0.16	0
2	SO4	F	500	-	4,4,4	0.11	0	6,6,6	0.11	0
2	SO4	A	500	-	4,4,4	0.10	0	6,6,6	0.13	0

There are no bond length outliers.

There are no bond angle outliers.

There are no chirality outliers.

There are no torsion outliers.

There are no ring outliers.

2 monomers are involved in 2 short contacts:

Mol	Chain	Res	Type	Clashes	Symm-Clashes
2	D	500	SO4	1	0
2	A	500	SO4	1	0

5.7 Other polymers [i](#)

There are no such residues in this entry.

5.8 Polymer linkage issues [i](#)

There are no chain breaks in this entry.

6 Fit of model and data [i](#)

6.1 Protein, DNA and RNA chains [i](#)

In the following table, the column labelled ‘#RSRZ > 2’ contains the number (and percentage) of RSRZ outliers, followed by percent RSRZ outliers for the chain as percentile scores relative to all X-ray entries and entries of similar resolution. The OWAB column contains the minimum, median, 95th percentile and maximum values of the occupancy-weighted average B-factor per residue. The column labelled ‘Q < 0.9’ lists the number of (and percentage) of residues with an average occupancy less than 0.9.

Mol	Chain	Analysed	<RSRZ>	#RSRZ>2	OWAB(Å ²)	Q<0.9
1	A	317/363 (87%)	-0.10	1 (0%) 94 90	147, 214, 328, 430	0
1	B	309/363 (85%)	-0.18	2 (0%) 89 84	170, 248, 343, 404	0
1	C	283/363 (77%)	-0.11	2 (0%) 87 82	185, 240, 325, 407	0
1	D	301/363 (82%)	-0.00	8 (2%) 54 44	213, 290, 368, 413	0
1	E	302/363 (83%)	0.10	13 (4%) 35 29	183, 281, 355, 644	0
1	F	293/363 (80%)	-0.10	9 (3%) 49 38	160, 246, 356, 410	0
All	All	1805/2178 (82%)	-0.07	35 (1%) 66 58	147, 255, 353, 644	0

The worst 5 of 35 RSRZ outliers are listed below:

Mol	Chain	Res	Type	RSRZ
1	E	109	GLU	4.6
1	C	205	GLU	4.4
1	E	107	GLY	4.3
1	E	106	ASN	4.2
1	A	149	THR	4.0

6.2 Non-standard residues in protein, DNA, RNA chains [i](#)

There are no non-standard protein/DNA/RNA residues in this entry.

6.3 Carbohydrates [i](#)

There are no monosaccharides in this entry.

6.4 Ligands [i](#)

In the following table, the Atoms column lists the number of modelled atoms in the group and the number defined in the chemical component dictionary. The B-factors column lists the minimum, median, 95th percentile and maximum values of B factors of atoms in the group. The column labelled 'Q< 0.9' lists the number of atoms with occupancy less than 0.9.

Mol	Type	Chain	Res	Atoms	RSCC	RSR	B-factors(Å ²)	Q<0.9
2	SO4	E	500	5/5	0.76	0.20	253,257,259,266	0
2	SO4	F	500	5/5	0.88	0.29	205,222,226,235	0
2	SO4	A	500	5/5	0.91	0.42	233,234,236,241	0
2	SO4	B	500	5/5	0.92	0.25	213,220,228,237	0
2	SO4	C	500	5/5	0.93	0.33	195,208,215,215	0
2	SO4	D	500	5/5	0.95	0.29	266,268,270,277	0

6.5 Other polymers [i](#)

There are no such residues in this entry.