



Full wwPDB X-ray Structure Validation Report ⓘ

Oct 25, 2023 – 04:31 AM EDT

PDB ID : 3A17
Title : Crystal Structure of Aldoxime Dehydratase (OxdRE) in Complex with Butyraldoxime (Co-crystal)
Authors : Sawai, H.; Sugimoto, H.; Kato, Y.; Asano, Y.; Shiro, Y.; Aono, S.
Deposited on : 2009-03-26
Resolution : 2.50 Å(reported)

This is a Full wwPDB X-ray Structure Validation Report for a publicly released PDB entry.

We welcome your comments at validation@mail.wwpdb.org

A user guide is available at

<https://www.wwpdb.org/validation/2017/XrayValidationReportHelp>

with specific help available everywhere you see the ⓘ symbol.

The types of validation reports are described at

<http://www.wwpdb.org/validation/2017/FAQs#types>.

The following versions of software and data (see [references ⓘ](#)) were used in the production of this report:

MolProbity : 4.02b-467
Mogul : 1.8.5 (274361), CSD as541be (2020)
Xtriage (Phenix) : 1.13
EDS : 2.36
buster-report : 1.1.7 (2018)
Percentile statistics : 20191225.v01 (using entries in the PDB archive December 25th 2019)
Refmac : 5.8.0158
CCP4 : 7.0.044 (Gargrove)
Ideal geometry (proteins) : Engh & Huber (2001)
Ideal geometry (DNA, RNA) : Parkinson et al. (1996)
Validation Pipeline (wwPDB-VP) : 2.36

1 Overall quality at a glance i

The following experimental techniques were used to determine the structure:

X-RAY DIFFRACTION

The reported resolution of this entry is 2.50 Å.

Percentile scores (ranging between 0-100) for global validation metrics of the entry are shown in the following graphic. The table shows the number of entries on which the scores are based.

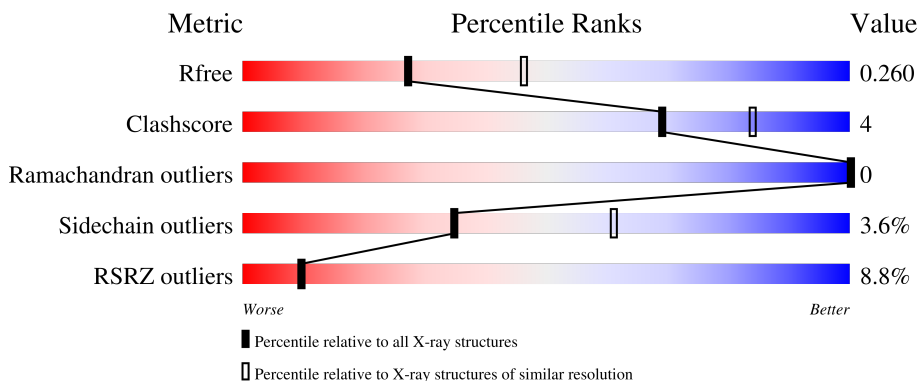



Metric	Whole archive (#Entries)	Similar resolution (#Entries, resolution range(Å))
R_{free}	130704	4661 (2.50-2.50)
Clashscore	141614	5346 (2.50-2.50)
Ramachandran outliers	138981	5231 (2.50-2.50)
Sidechain outliers	138945	5233 (2.50-2.50)
RSRZ outliers	127900	4559 (2.50-2.50)

The table below summarises the geometric issues observed across the polymeric chains and their fit to the electron density. The red, orange, yellow and green segments of the lower bar indicate the fraction of residues that contain outliers for ≥ 3 , 2, 1 and 0 types of geometric quality criteria respectively. A grey segment represents the fraction of residues that are not modelled. The numeric value for each fraction is indicated below the corresponding segment, with a dot representing fractions $\leq 5\%$. The upper red bar (where present) indicates the fraction of residues that have poor fit to the electron density. The numeric value is given above the bar.

Mol	Chain	Length	Quality of chain
1	A	373	
1	B	373	
1	C	373	
1	D	373	
1	E	373	

Continued on next page...

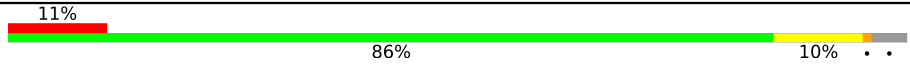
Continued from previous page...

Mol	Chain	Length	Quality of chain
1	F	373	 11% 86% 10% • •
1	G	373	 6% 85% 9% • 5%
1	H	373	 12% 85% 11% • •

2 Entry composition [i](#)

There are 4 unique types of molecules in this entry. The entry contains 23656 atoms, of which 0 are hydrogens and 0 are deuteriums.

In the tables below, the ZeroOcc column contains the number of atoms modelled with zero occupancy, the AltConf column contains the number of residues with at least one atom in alternate conformation and the Trace column contains the number of residues modelled with at most 2 atoms.

- Molecule 1 is a protein called Aldoxime dehydratase.

Mol	Chain	Residues	Atoms					ZeroOcc	AltConf	Trace
			Total	C	N	O	S			
1	A	350	2790	1757	492	529	12	0	0	0
1	B	359	2853	1795	506	540	12	0	0	0
1	C	352	2812	1770	497	533	12	0	1	0
1	D	360	2866	1803	510	541	12	0	1	0
1	E	351	2803	1765	496	530	12	0	1	0
1	F	359	2853	1795	506	540	12	0	0	0
1	G	353	2815	1771	497	535	12	0	0	0
1	H	359	2853	1795	506	540	12	0	0	0

There are 160 discrepancies between the modelled and reference sequences:

Chain	Residue	Modelled	Actual	Comment	Reference
A	-19	MET	-	initiating methionine	UNP Q76K71
A	-18	GLY	-	expression tag	UNP Q76K71
A	-17	SER	-	expression tag	UNP Q76K71
A	-16	SER	-	expression tag	UNP Q76K71
A	-15	HIS	-	expression tag	UNP Q76K71
A	-14	HIS	-	expression tag	UNP Q76K71
A	-13	HIS	-	expression tag	UNP Q76K71
A	-12	HIS	-	expression tag	UNP Q76K71
A	-11	HIS	-	expression tag	UNP Q76K71
A	-10	HIS	-	expression tag	UNP Q76K71
A	-9	SER	-	expression tag	UNP Q76K71
A	-8	SER	-	expression tag	UNP Q76K71
A	-7	GLY	-	expression tag	UNP Q76K71

Continued on next page...

Continued from previous page...

Chain	Residue	Modelled	Actual	Comment	Reference
A	-6	LEU	-	expression tag	UNP Q76K71
A	-5	VAL	-	expression tag	UNP Q76K71
A	-4	PRO	-	expression tag	UNP Q76K71
A	-3	ARG	-	expression tag	UNP Q76K71
A	-2	GLY	-	expression tag	UNP Q76K71
A	-1	SER	-	expression tag	UNP Q76K71
A	0	HIS	-	expression tag	UNP Q76K71
B	-19	MET	-	initiating methionine	UNP Q76K71
B	-18	GLY	-	expression tag	UNP Q76K71
B	-17	SER	-	expression tag	UNP Q76K71
B	-16	SER	-	expression tag	UNP Q76K71
B	-15	HIS	-	expression tag	UNP Q76K71
B	-14	HIS	-	expression tag	UNP Q76K71
B	-13	HIS	-	expression tag	UNP Q76K71
B	-12	HIS	-	expression tag	UNP Q76K71
B	-11	HIS	-	expression tag	UNP Q76K71
B	-10	HIS	-	expression tag	UNP Q76K71
B	-9	SER	-	expression tag	UNP Q76K71
B	-8	SER	-	expression tag	UNP Q76K71
B	-7	GLY	-	expression tag	UNP Q76K71
B	-6	LEU	-	expression tag	UNP Q76K71
B	-5	VAL	-	expression tag	UNP Q76K71
B	-4	PRO	-	expression tag	UNP Q76K71
B	-3	ARG	-	expression tag	UNP Q76K71
B	-2	GLY	-	expression tag	UNP Q76K71
B	-1	SER	-	expression tag	UNP Q76K71
B	0	HIS	-	expression tag	UNP Q76K71
C	-19	MET	-	initiating methionine	UNP Q76K71
C	-18	GLY	-	expression tag	UNP Q76K71
C	-17	SER	-	expression tag	UNP Q76K71
C	-16	SER	-	expression tag	UNP Q76K71
C	-15	HIS	-	expression tag	UNP Q76K71
C	-14	HIS	-	expression tag	UNP Q76K71
C	-13	HIS	-	expression tag	UNP Q76K71
C	-12	HIS	-	expression tag	UNP Q76K71
C	-11	HIS	-	expression tag	UNP Q76K71
C	-10	HIS	-	expression tag	UNP Q76K71
C	-9	SER	-	expression tag	UNP Q76K71
C	-8	SER	-	expression tag	UNP Q76K71
C	-7	GLY	-	expression tag	UNP Q76K71
C	-6	LEU	-	expression tag	UNP Q76K71
C	-5	VAL	-	expression tag	UNP Q76K71

Continued on next page...

Continued from previous page...

Chain	Residue	Modelled	Actual	Comment	Reference
C	-4	PRO	-	expression tag	UNP Q76K71
C	-3	ARG	-	expression tag	UNP Q76K71
C	-2	GLY	-	expression tag	UNP Q76K71
C	-1	SER	-	expression tag	UNP Q76K71
C	0	HIS	-	expression tag	UNP Q76K71
D	-19	MET	-	initiating methionine	UNP Q76K71
D	-18	GLY	-	expression tag	UNP Q76K71
D	-17	SER	-	expression tag	UNP Q76K71
D	-16	SER	-	expression tag	UNP Q76K71
D	-15	HIS	-	expression tag	UNP Q76K71
D	-14	HIS	-	expression tag	UNP Q76K71
D	-13	HIS	-	expression tag	UNP Q76K71
D	-12	HIS	-	expression tag	UNP Q76K71
D	-11	HIS	-	expression tag	UNP Q76K71
D	-10	HIS	-	expression tag	UNP Q76K71
D	-9	SER	-	expression tag	UNP Q76K71
D	-8	SER	-	expression tag	UNP Q76K71
D	-7	GLY	-	expression tag	UNP Q76K71
D	-6	LEU	-	expression tag	UNP Q76K71
D	-5	VAL	-	expression tag	UNP Q76K71
D	-4	PRO	-	expression tag	UNP Q76K71
D	-3	ARG	-	expression tag	UNP Q76K71
D	-2	GLY	-	expression tag	UNP Q76K71
D	-1	SER	-	expression tag	UNP Q76K71
D	0	HIS	-	expression tag	UNP Q76K71
E	-19	MET	-	initiating methionine	UNP Q76K71
E	-18	GLY	-	expression tag	UNP Q76K71
E	-17	SER	-	expression tag	UNP Q76K71
E	-16	SER	-	expression tag	UNP Q76K71
E	-15	HIS	-	expression tag	UNP Q76K71
E	-14	HIS	-	expression tag	UNP Q76K71
E	-13	HIS	-	expression tag	UNP Q76K71
E	-12	HIS	-	expression tag	UNP Q76K71
E	-11	HIS	-	expression tag	UNP Q76K71
E	-10	HIS	-	expression tag	UNP Q76K71
E	-9	SER	-	expression tag	UNP Q76K71
E	-8	SER	-	expression tag	UNP Q76K71
E	-7	GLY	-	expression tag	UNP Q76K71
E	-6	LEU	-	expression tag	UNP Q76K71
E	-5	VAL	-	expression tag	UNP Q76K71
E	-4	PRO	-	expression tag	UNP Q76K71
E	-3	ARG	-	expression tag	UNP Q76K71

Continued on next page...

Continued from previous page...

Chain	Residue	Modelled	Actual	Comment	Reference
E	-2	GLY	-	expression tag	UNP Q76K71
E	-1	SER	-	expression tag	UNP Q76K71
E	0	HIS	-	expression tag	UNP Q76K71
F	-19	MET	-	initiating methionine	UNP Q76K71
F	-18	GLY	-	expression tag	UNP Q76K71
F	-17	SER	-	expression tag	UNP Q76K71
F	-16	SER	-	expression tag	UNP Q76K71
F	-15	HIS	-	expression tag	UNP Q76K71
F	-14	HIS	-	expression tag	UNP Q76K71
F	-13	HIS	-	expression tag	UNP Q76K71
F	-12	HIS	-	expression tag	UNP Q76K71
F	-11	HIS	-	expression tag	UNP Q76K71
F	-10	HIS	-	expression tag	UNP Q76K71
F	-9	SER	-	expression tag	UNP Q76K71
F	-8	SER	-	expression tag	UNP Q76K71
F	-7	GLY	-	expression tag	UNP Q76K71
F	-6	LEU	-	expression tag	UNP Q76K71
F	-5	VAL	-	expression tag	UNP Q76K71
F	-4	PRO	-	expression tag	UNP Q76K71
F	-3	ARG	-	expression tag	UNP Q76K71
F	-2	GLY	-	expression tag	UNP Q76K71
F	-1	SER	-	expression tag	UNP Q76K71
F	0	HIS	-	expression tag	UNP Q76K71
G	-19	MET	-	initiating methionine	UNP Q76K71
G	-18	GLY	-	expression tag	UNP Q76K71
G	-17	SER	-	expression tag	UNP Q76K71
G	-16	SER	-	expression tag	UNP Q76K71
G	-15	HIS	-	expression tag	UNP Q76K71
G	-14	HIS	-	expression tag	UNP Q76K71
G	-13	HIS	-	expression tag	UNP Q76K71
G	-12	HIS	-	expression tag	UNP Q76K71
G	-11	HIS	-	expression tag	UNP Q76K71
G	-10	HIS	-	expression tag	UNP Q76K71
G	-9	SER	-	expression tag	UNP Q76K71
G	-8	SER	-	expression tag	UNP Q76K71
G	-7	GLY	-	expression tag	UNP Q76K71
G	-6	LEU	-	expression tag	UNP Q76K71
G	-5	VAL	-	expression tag	UNP Q76K71
G	-4	PRO	-	expression tag	UNP Q76K71
G	-3	ARG	-	expression tag	UNP Q76K71
G	-2	GLY	-	expression tag	UNP Q76K71
G	-1	SER	-	expression tag	UNP Q76K71

Continued on next page...

Continued from previous page...

Chain	Residue	Modelled	Actual	Comment	Reference
G	0	HIS	-	expression tag	UNP Q76K71
H	-19	MET	-	initiating methionine	UNP Q76K71
H	-18	GLY	-	expression tag	UNP Q76K71
H	-17	SER	-	expression tag	UNP Q76K71
H	-16	SER	-	expression tag	UNP Q76K71
H	-15	HIS	-	expression tag	UNP Q76K71
H	-14	HIS	-	expression tag	UNP Q76K71
H	-13	HIS	-	expression tag	UNP Q76K71
H	-12	HIS	-	expression tag	UNP Q76K71
H	-11	HIS	-	expression tag	UNP Q76K71
H	-10	HIS	-	expression tag	UNP Q76K71
H	-9	SER	-	expression tag	UNP Q76K71
H	-8	SER	-	expression tag	UNP Q76K71
H	-7	GLY	-	expression tag	UNP Q76K71
H	-6	LEU	-	expression tag	UNP Q76K71
H	-5	VAL	-	expression tag	UNP Q76K71
H	-4	PRO	-	expression tag	UNP Q76K71
H	-3	ARG	-	expression tag	UNP Q76K71
H	-2	GLY	-	expression tag	UNP Q76K71
H	-1	SER	-	expression tag	UNP Q76K71
H	0	HIS	-	expression tag	UNP Q76K71

- Molecule 2 is PROTOPORPHYRIN IX CONTAINING FE (three-letter code: HEM) (formula: $C_{34}H_{32}FeN_4O_4$).

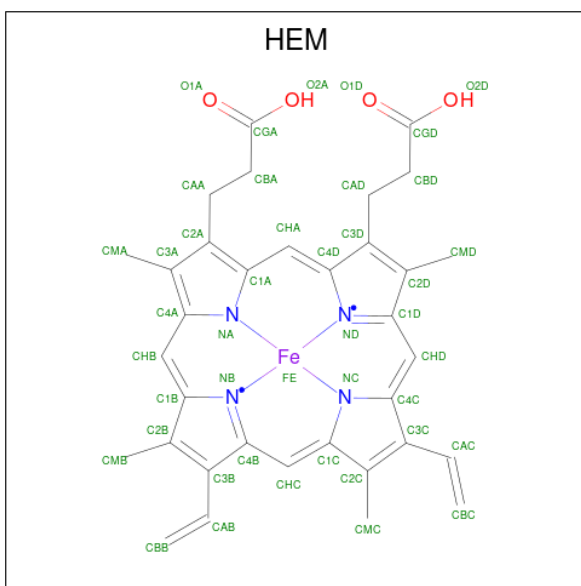

Mol	Chain	Residues	Atoms				ZeroOcc	AltConf	
2	A	1	Total	C	Fe	N	O	0	0
			43	34	1	4	4		
2	B	1	Total	C	Fe	N	O	0	0
			43	34	1	4	4		
2	C	1	Total	C	Fe	N	O	0	0
			43	34	1	4	4		
2	D	1	Total	C	Fe	N	O	0	0
			43	34	1	4	4		
2	E	1	Total	C	Fe	N	O	0	0
			43	34	1	4	4		
2	F	1	Total	C	Fe	N	O	0	0
			43	34	1	4	4		
2	G	1	Total	C	Fe	N	O	0	0
			43	34	1	4	4		
2	H	1	Total	C	Fe	N	O	0	0
			43	34	1	4	4		

- Molecule 3 is (1Z)-butanal oxime (three-letter code: BXO) (formula: C₄H₉NO).

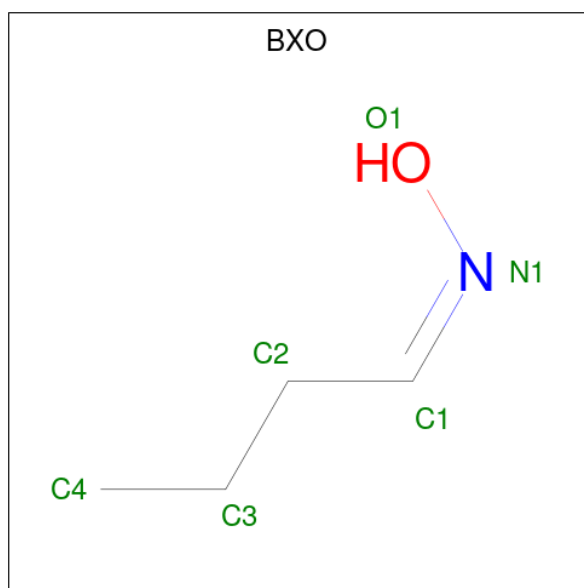

Mol	Chain	Residues	Atoms			ZeroOcc	AltConf	
3	A	1	Total	C	N	O	0	0
			6	4	1	1		
3	B	1	Total	C	N	O	0	0
			6	4	1	1		
3	C	1	Total	C	N	O	0	0
			6	4	1	1		
3	D	1	Total	C	N	O	0	0
			6	4	1	1		

Continued on next page...

Continued from previous page...

Mol	Chain	Residues	Atoms				ZeroOcc	AltConf
3	E	1	Total	C	N	O	0	0
			6	4	1	1		
3	F	1	Total	C	N	O	0	0
			6	4	1	1		
3	G	1	Total	C	N	O	0	0
			6	4	1	1		
3	H	1	Total	C	N	O	0	0
			6	4	1	1		

- Molecule 4 is water.

Mol	Chain	Residues	Atoms		ZeroOcc	AltConf
4	A	105	Total	O	0	0
			105	105		
4	B	60	Total	O	0	0
			60	60		
4	C	93	Total	O	0	0
			93	93		
4	D	77	Total	O	0	0
			77	77		
4	E	83	Total	O	0	0
			83	83		
4	F	58	Total	O	0	0
			58	58		
4	G	84	Total	O	0	0
			84	84		
4	H	59	Total	O	0	0
			59	59		

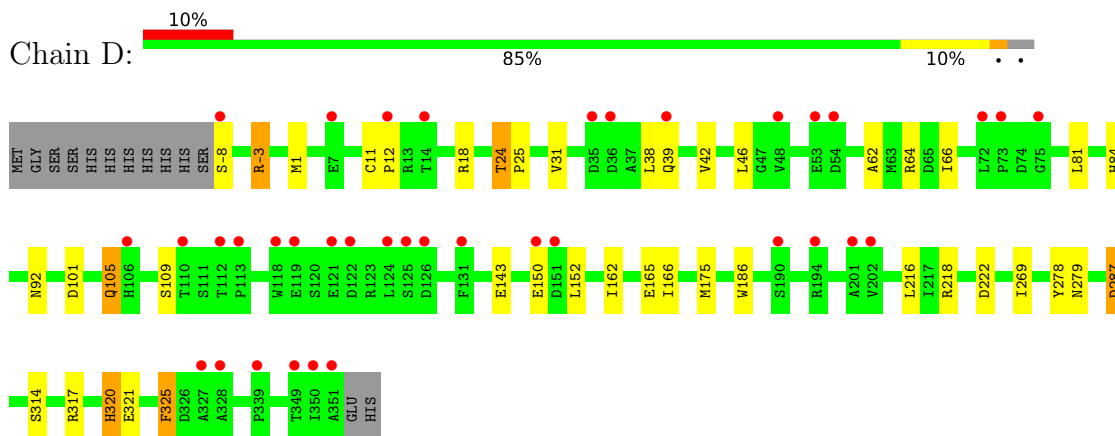

- Molecule 1: Aldoxime dehydratase

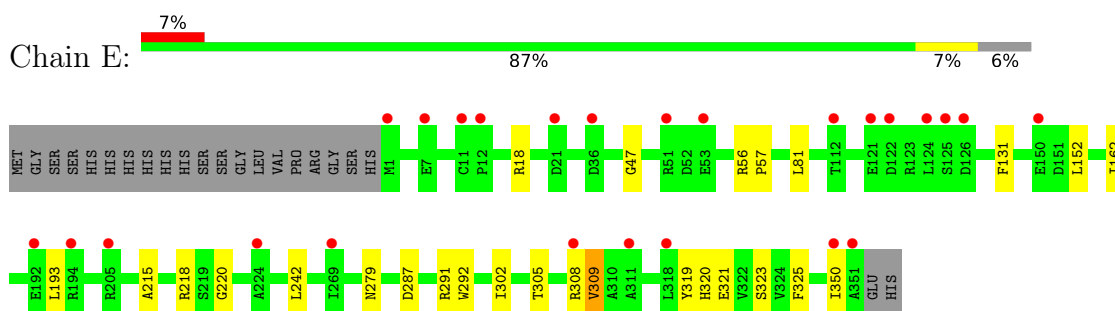

- Molecule 1: Aldoxime dehydratase

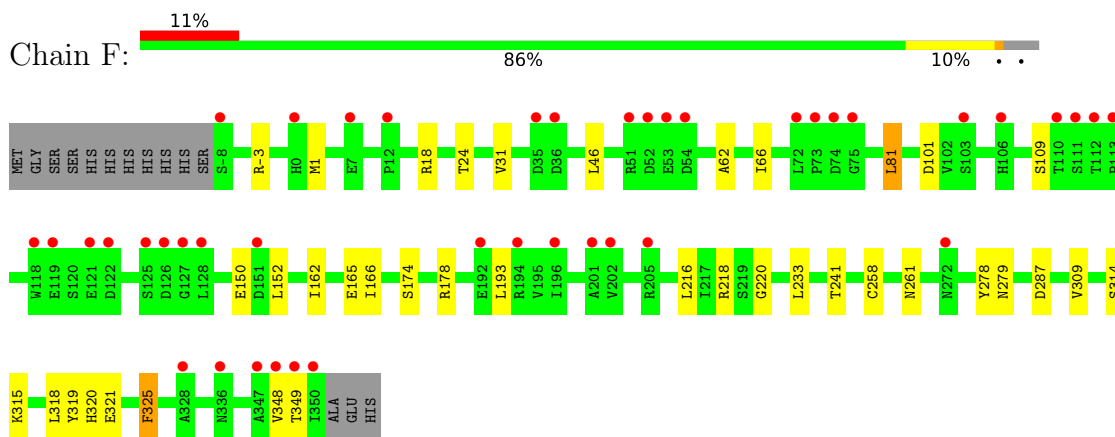

- Molecule 1: Aldoxime dehydratase

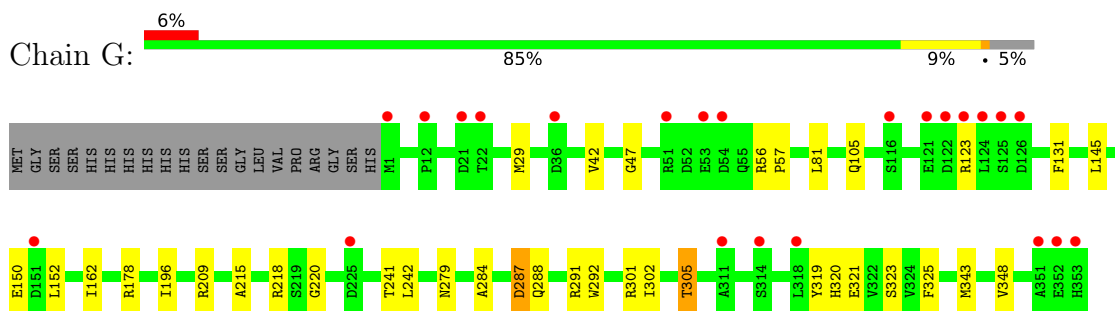

- Molecule 1: Aldoxime dehydratase

Chain H: 

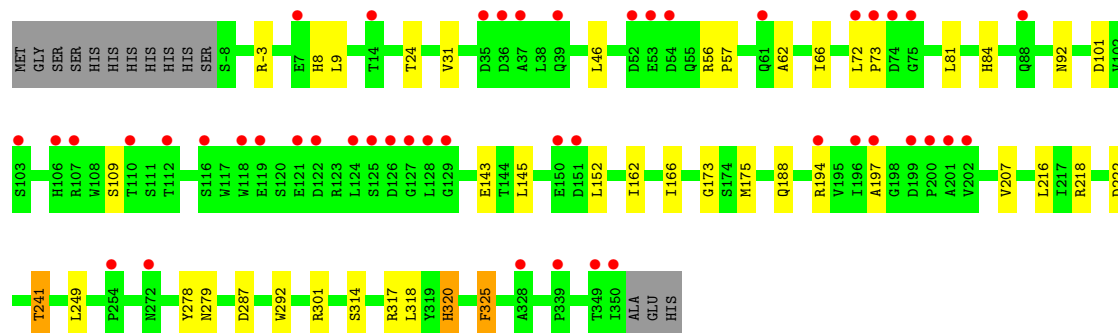

4 Data and refinement statistics i

Property	Value	Source
Space group	P 1	Depositor
Cell constants a, b, c, α , β , γ	80.05Å 103.93Å 114.19Å 76.50° 89.46° 87.55°	Depositor
Resolution (Å)	19.90 – 2.50 19.90 – 2.50	Depositor EDS
% Data completeness (in resolution range)	91.2 (19.90-2.50) 91.2 (19.90-2.50)	Depositor EDS
R_{merge}	0.08	Depositor
R_{sym}	(Not available)	Depositor
$\langle I/\sigma(I) \rangle$ ¹	2.30 (at 2.50Å)	Xtrriage
Refinement program	REFMAC refmac_5.2.0019	Depositor
R, R_{free}	0.211 , 0.243 0.225 , 0.260	Depositor DCC
R_{free} test set	5656 reflections (5.02%)	wwPDB-VP
Wilson B-factor (Å ²)	30.5	Xtrriage
Anisotropy	0.447	Xtrriage
Bulk solvent k_{sol} (e/Å ³), B_{sol} (Å ²)	0.39 , 41.9	EDS
L-test for twinning ²	$\langle L \rangle = 0.50$, $\langle L^2 \rangle = 0.33$	Xtrriage
Estimated twinning fraction	0.098 for h,-k,-l	Xtrriage
F_o, F_c correlation	0.92	EDS
Total number of atoms	23656	wwPDB-VP
Average B, all atoms (Å ²)	29.0	wwPDB-VP

Xtrriage's analysis on translational NCS is as follows: *The largest off-origin peak in the Patterson function is 4.34% of the height of the origin peak. No significant pseudotranslation is detected.*

¹Intensities estimated from amplitudes.

²Theoretical values of $\langle |L| \rangle$, $\langle L^2 \rangle$ for acentric reflections are 0.5, 0.333 respectively for untwinned datasets, and 0.375, 0.2 for perfectly twinned datasets.

5 Model quality [i](#)

5.1 Standard geometry [i](#)

Bond lengths and bond angles in the following residue types are not validated in this section: HEM, BXO

The Z score for a bond length (or angle) is the number of standard deviations the observed value is removed from the expected value. A bond length (or angle) with $|Z| > 5$ is considered an outlier worth inspection. RMSZ is the root-mean-square of all Z scores of the bond lengths (or angles).

Mol	Chain	Bond lengths		Bond angles	
		RMSZ	# Z >5	RMSZ	# Z >5
1	A	0.44	0/2866	0.57	0/3900
1	B	0.42	0/2931	0.57	0/3988
1	C	0.44	0/2891	0.57	0/3934
1	D	0.44	0/2947	0.58	0/4009
1	E	0.43	0/2882	0.58	0/3921
1	F	0.42	0/2931	0.57	0/3988
1	G	0.44	0/2892	0.58	0/3934
1	H	0.42	0/2931	0.56	0/3988
All	All	0.43	0/23271	0.57	0/31662

There are no bond length outliers.

There are no bond angle outliers.

There are no chirality outliers.

There are no planarity outliers.

5.2 Too-close contacts [i](#)

In the following table, the Non-H and H(model) columns list the number of non-hydrogen atoms and hydrogen atoms in the chain respectively. The H(added) column lists the number of hydrogen atoms added and optimized by MolProbity. The Clashes column lists the number of clashes within the asymmetric unit, whereas Symm-Clashes lists symmetry-related clashes.

Mol	Chain	Non-H	H(model)	H(added)	Clashes	Symm-Clashes
1	A	2790	0	2628	25	0
1	B	2853	0	2691	18	0
1	C	2812	0	2652	21	0
1	D	2866	0	2709	30	0
1	E	2803	0	2646	16	0

Continued on next page...

Continued from previous page...

Mol	Chain	Non-H	H(model)	H(added)	Clashes	Symm-Clashes
1	F	2853	0	2691	16	0
1	G	2815	0	2646	21	0
1	H	2853	0	2691	21	0
2	A	43	0	30	4	0
2	B	43	0	30	2	0
2	C	43	0	30	4	0
2	D	43	0	30	1	0
2	E	43	0	30	4	0
2	F	43	0	30	2	0
2	G	43	0	30	4	0
2	H	43	0	30	3	0
3	A	6	0	9	2	0
3	B	6	0	9	1	0
3	C	6	0	9	0	0
3	D	6	0	9	1	0
3	E	6	0	9	0	0
3	F	6	0	9	1	0
3	G	6	0	9	1	0
3	H	6	0	9	3	0
4	A	105	0	0	1	0
4	B	60	0	0	1	0
4	C	93	0	0	0	0
4	D	77	0	0	3	0
4	E	83	0	0	0	0
4	F	58	0	0	0	0
4	G	84	0	0	0	0
4	H	59	0	0	1	0
All	All	23656	0	21666	163	0

The all-atom clashscore is defined as the number of clashes found per 1000 atoms (including hydrogen atoms). The all-atom clashscore for this structure is 4.

All (163) close contacts within the same asymmetric unit are listed below, sorted by their clash magnitude.

Atom-1	Atom-2	Interatomic distance (Å)	Clash overlap (Å)
1:D:-3[A]:ARG:HG2	1:D:-3[A]:ARG:HH11	1.41	0.84
1:G:242:LEU:HD22	2:G:354:HEM:HBB1	1.64	0.80
1:E:242:LEU:HD22	2:E:354:HEM:HBB1	1.69	0.75
1:E:305:THR:O	1:E:309:VAL:HG23	1.88	0.73
1:C:242:LEU:HD22	2:C:354:HEM:HBB1	1.70	0.73
1:D:-8:SER:HA	4:D:516:HOH:O	1.89	0.70

Continued on next page...

Continued from previous page...

Atom-1	Atom-2	Interatomic distance (Å)	Clash overlap (Å)
1:F:318:LEU:HD22	2:F:354:HEM:HBB2	1.73	0.70
1:A:29:MET:HE1	3:A:355:BXO:H4	1.74	0.69
1:G:302:ILE:HA	1:G:305:THR:HG23	1.75	0.67
1:E:308:ARG:HE	1:E:309:VAL:HG22	1.58	0.67
1:G:292:TRP:CZ3	2:G:354:HEM:HBC2	2.29	0.67
1:D:-3[A]:ARG:HG2	1:D:-3[A]:ARG:NH1	2.09	0.64
1:B:31:VAL:HG13	1:B:166:ILE:HG12	1.78	0.64
1:A:235:LEU:HB3	1:D:-3[A]:ARG:HD2	1.79	0.63
1:H:318:LEU:HD22	2:H:354:HEM:HBB2	1.79	0.63
1:C:218:ARG:HB3	1:C:321:GLU:HG2	1.80	0.62
1:A:218:ARG:HB3	1:A:321:GLU:HG2	1.80	0.62
1:G:242:LEU:HD22	2:G:354:HEM:CBB	2.30	0.61
1:F:218:ARG:HG3	1:F:278:TYR:CD2	2.36	0.61
1:A:242:LEU:HD22	2:A:354:HEM:HBB1	1.82	0.60
1:H:218:ARG:HG3	1:H:278:TYR:CD2	2.37	0.59
1:A:292:TRP:CZ3	2:A:354:HEM:HBC2	2.37	0.59
1:G:301:ARG:O	1:G:305:THR:HG22	2.04	0.58
1:C:152:LEU:HD21	1:C:162:ILE:HD13	1.85	0.57
1:E:242:LEU:HD22	2:E:354:HEM:CBB	2.35	0.57
1:B:318:LEU:HD22	2:B:354:HEM:HBB2	1.86	0.57
1:G:218:ARG:HB3	1:G:321:GLU:HG2	1.87	0.56
1:E:218:ARG:HB3	1:E:321:GLU:HG2	1.87	0.56
1:A:235:LEU:HB3	1:D:-3[B]:ARG:HD2	1.86	0.56
1:F:31:VAL:HG13	1:F:166:ILE:HG12	1.87	0.56
1:C:150:GLU:OE1	1:C:150:GLU:N	2.37	0.55
1:B:218:ARG:HG3	1:B:278:TYR:CD2	2.42	0.55
1:C:292:TRP:CZ3	2:C:354:HEM:HBC2	2.42	0.55
1:B:81:LEU:HD23	1:B:81:LEU:N	2.22	0.54
1:G:292:TRP:HZ3	2:G:354:HEM:HBC2	1.70	0.54
1:E:292:TRP:CZ3	2:E:354:HEM:HBC2	2.42	0.54
1:H:216:LEU:HB3	1:H:325:PHE:HZ	1.73	0.54
1:H:31:VAL:HG13	1:H:166:ILE:HG12	1.89	0.54
1:B:251:ASP:HB3	1:C:202:VAL:HG21	1.90	0.53
1:B:244:SER:OG	1:C:351:ALA:HB3	2.07	0.53
1:E:220:GLY:HA3	1:E:319:TYR:CE1	2.44	0.53
1:F:233:LEU:HD21	1:F:309:VAL:HG11	1.91	0.52
1:C:242:LEU:HD22	2:C:354:HEM:CBB	2.38	0.52
1:A:193:LEU:HD11	1:A:343:MET:HG3	1.92	0.52
1:H:145:LEU:HD23	3:H:355:BXO:C4	2.39	0.52
1:A:152:LEU:HD21	1:A:162:ILE:HD13	1.92	0.52
1:C:287:ASP:O	1:C:291:ARG:HG2	2.09	0.51

Continued on next page...

Continued from previous page...

Atom-1	Atom-2	Interatomic distance (Å)	Clash overlap (Å)
1:D:42:VAL:HG11	1:D:105:GLN:HG3	1.91	0.51
1:F:220:GLY:HA3	1:F:319:TYR:CE1	2.46	0.51
1:G:287:ASP:O	1:G:291:ARG:HG2	2.12	0.50
1:D:287:ASP:OD1	1:D:287:ASP:N	2.44	0.50
1:G:42:VAL:HG11	1:G:105:GLN:HG3	1.94	0.50
1:A:292:TRP:HZ3	2:A:354:HEM:HBC2	1.77	0.49
1:B:218:ARG:HA	1:B:279:ASN:O	2.13	0.49
1:F:1:MET:HE3	1:F:165:GLU:HB3	1.94	0.49
1:F:218:ARG:HA	1:F:279:ASN:O	2.12	0.49
1:D:218:ARG:HG3	1:D:278:TYR:CD2	2.48	0.49
1:D:31:VAL:HG13	1:D:166:ILE:HG12	1.93	0.49
1:H:72:LEU:HB3	1:H:73:PRO:HD2	1.95	0.49
1:A:302:ILE:HD12	2:A:354:HEM:HBB2	1.94	0.49
1:D:218:ARG:HA	1:D:279:ASN:O	2.13	0.49
1:F:174:SER:O	1:F:178:ARG:HG3	2.13	0.48
1:H:218:ARG:HA	1:H:279:ASN:O	2.13	0.48
1:E:287:ASP:O	1:E:291:ARG:HG2	2.13	0.48
1:C:220:GLY:HA3	1:C:319:TYR:CE1	2.49	0.47
1:H:145:LEU:HD23	3:H:355:BXO:H4A	1.95	0.47
1:C:117:TRP:O	1:C:123:ARG:NH1	2.47	0.47
1:E:215:ALA:HA	1:E:323:SER:O	2.15	0.47
1:C:215:ALA:HA	1:C:323:SER:O	2.14	0.47
1:E:302:ILE:HD12	2:E:354:HEM:HBB2	1.96	0.47
1:H:222:ASP:HB3	1:H:317:ARG:HB2	1.96	0.47
1:H:84:HIS:CE1	1:H:92:ASN:HB2	2.49	0.47
1:B:287:ASP:OD1	1:B:287:ASP:N	2.44	0.47
1:D:218:ARG:HB3	1:D:321:GLU:HG2	1.96	0.47
1:A:220:GLY:HA3	1:A:319:TYR:CE1	2.50	0.46
1:G:29:MET:HE1	3:G:355:BXO:H4	1.98	0.46
1:D:62:ALA:O	1:D:66:ILE:HG13	2.16	0.46
1:B:222:ASP:HB3	1:B:317:ARG:HB2	1.96	0.46
1:G:152:LEU:HD21	1:G:162:ILE:HD13	1.98	0.46
1:A:215:ALA:HA	1:A:323:SER:O	2.16	0.46
1:B:320:HIS:CD2	1:B:320:HIS:C	2.89	0.46
1:D:222:ASP:HB3	1:D:317:ARG:HB2	1.97	0.46
1:G:215:ALA:HA	1:G:323:SER:O	2.15	0.46
1:H:320:HIS:CD2	1:H:320:HIS:C	2.88	0.46
1:E:218:ARG:HA	1:E:279:ASN:O	2.16	0.46
1:F:152:LEU:HD21	1:F:162:ILE:HD13	1.98	0.46
1:A:29:MET:CE	3:A:355:BXO:H4	2.44	0.45
1:C:211:HIS:CE1	1:C:214:ILE:HG13	2.52	0.45

Continued on next page...

Continued from previous page...

Atom-1	Atom-2	Interatomic distance (Å)	Clash overlap (Å)
1:F:216:LEU:HB3	1:F:325:PHE:HZ	1.80	0.45
1:A:236:ASP:OD1	1:D:3[B]:ARG:HD3	2.17	0.45
1:D:84:HIS:CE1	1:D:92:ASN:HB2	2.51	0.45
1:F:193:LEU:O	1:F:348:VAL:HG12	2.17	0.45
1:F:218:ARG:HB3	1:F:321:GLU:HG2	1.99	0.44
1:A:287:ASP:O	1:A:291:ARG:HG2	2.16	0.44
1:D:143:GLU:OE2	1:D:175:MET:HG3	2.18	0.44
1:G:220:GLY:HA3	1:G:319:TYR:CE1	2.53	0.44
1:H:249:LEU:HD21	1:H:292:TRP:CE2	2.52	0.44
1:D:11:CYS:HB2	1:D:12:PRO:HD2	1.99	0.44
1:E:308:ARG:NE	1:E:309:VAL:HG22	2.31	0.44
1:G:150:GLU:N	1:G:150:GLU:OE1	2.49	0.44
1:G:218:ARG:HA	1:G:279:ASN:O	2.18	0.44
1:G:47:GLY:HA3	1:G:131:PHE:CZ	2.53	0.44
1:A:145:LEU:HD22	1:A:178:ARG:NH2	2.33	0.44
1:B:216:LEU:HB3	1:B:325:PHE:HZ	1.83	0.44
1:D:39:GLN:HG2	4:D:514:HOH:O	2.17	0.44
1:A:186:TRP:HH2	1:B:17:ARG:O	1.99	0.43
1:B:218:ARG:HB3	1:B:321:GLU:HG2	2.00	0.43
1:H:173:GLY:HA2	4:H:374:HOH:O	2.18	0.43
1:E:18:ARG:HD2	1:F:18:ARG:HD2	2.00	0.43
1:A:194:ARG:HG2	1:A:348:VAL:CG2	2.49	0.43
1:C:17:ARG:O	1:D:186:TRP:HH2	2.01	0.43
1:F:81:LEU:N	1:F:81:LEU:HD23	2.33	0.43
1:G:196:ILE:HD13	1:G:209:ARG:HB2	2.00	0.43
1:C:233:LEU:HA	1:C:237:GLU:HG3	2.01	0.43
1:G:145:LEU:HD22	1:G:178:ARG:NH2	2.34	0.43
1:G:56:ARG:HB3	1:G:57:PRO:HD3	2.00	0.43
1:A:132:ARG:HG2	1:A:333:GLU:HB2	2.01	0.42
1:B:84:HIS:CE1	1:B:92:ASN:HB2	2.54	0.42
1:D:320:HIS:CD2	1:D:320:HIS:C	2.92	0.42
1:F:62:ALA:O	1:F:66:ILE:HG13	2.19	0.42
1:C:218:ARG:HA	1:C:279:ASN:O	2.19	0.42
1:C:241:THR:HG21	1:C:301:ARG:HB3	2.01	0.42
1:E:56:ARG:HB3	1:E:57:PRO:HD3	2.00	0.42
1:B:173:GLY:HA2	4:B:367:HOH:O	2.20	0.42
1:D:152:LEU:HD21	1:D:162:ILE:HD13	2.01	0.42
1:A:218:ARG:HA	1:A:279:ASN:O	2.19	0.42
1:D:11:CYS:HB2	1:D:12:PRO:CD	2.49	0.41
1:D:24:THR:HA	1:D:25:PRO:HD3	1.95	0.41
1:A:56:ARG:HB3	1:A:57:PRO:HD3	2.02	0.41

Continued on next page...

Continued from previous page...

Atom-1	Atom-2	Interatomic distance (Å)	Clash overlap (Å)
1:C:18:ARG:HD2	1:D:18:ARG:HD2	2.01	0.41
1:C:42:VAL:HG11	1:C:105:GLN:HG3	2.02	0.41
1:H:143:GLU:OE2	1:H:175:MET:HG3	2.20	0.41
1:C:302:ILE:HD12	2:C:354:HEM:HBB2	2.02	0.41
1:E:152:LEU:HD21	1:E:162:ILE:HD13	2.02	0.41
1:C:76:PRO:HD3	1:C:99:TRP:CZ2	2.55	0.41
1:D:216:LEU:HB3	1:D:325:PHE:HZ	1.86	0.41
1:H:62:ALA:O	1:H:66:ILE:HG13	2.20	0.41
1:A:209:ARG:NE	4:A:588:HOH:O	2.52	0.41
1:D:218:ARG:HB3	1:D:321:GLU:CG	2.50	0.41
2:D:354:HEM:C4A	3:D:355:BXO:H1	2.56	0.41
1:E:47:GLY:HA3	1:E:131:PHE:CZ	2.56	0.41
1:F:258:CYS:SG	1:F:261:ASN:HB2	2.61	0.41
1:A:254:PRO:HD3	1:A:345:ARG:NH2	2.36	0.41
1:D:1:MET:HE2	1:D:25:PRO:HG2	2.02	0.41
1:H:152:LEU:HD21	1:H:162:ILE:HD13	2.02	0.41
2:B:354:HEM:C4A	3:B:355:BXO:H1	2.56	0.41
1:H:241:THR:HG21	1:H:301:ARG:HD3	2.03	0.41
1:A:123:ARG:HA	1:A:123:ARG:HD3	1.92	0.41
1:B:8:HIS:CE1	1:B:9:LEU:HG	2.56	0.41
1:B:258:CYS:SG	1:B:261:ASN:HB2	2.61	0.41
1:H:56:ARG:HB3	1:H:57:PRO:HD3	2.03	0.41
1:H:197:ALA:HB3	1:H:207:VAL:HB	2.03	0.41
1:D:12:PRO:HD3	4:D:598:HOH:O	2.20	0.41
1:D:1:MET:HE3	1:D:165:GLU:HB3	2.03	0.40
1:B:152:LEU:HD21	1:B:162:ILE:HD13	2.02	0.40
2:H:354:HEM:C4A	3:H:355:BXO:H1	2.56	0.40
1:A:196:ILE:HD13	1:A:209:ARG:HB2	2.02	0.40
1:D:64:ARG:HG2	1:D:269:ILE:HD11	2.04	0.40
1:G:284:ALA:HB3	1:G:288:GLN:HE22	1.87	0.40
1:H:279:ASN:OD1	2:H:354:HEM:HAC	2.22	0.40
2:F:354:HEM:C4A	3:F:355:BXO:H1	2.56	0.40
1:G:241:THR:OG1	1:G:302:ILE:HG23	2.22	0.40
1:H:8:HIS:CE1	1:H:9:LEU:HG	2.56	0.40

There are no symmetry-related clashes.

5.3 Torsion angles [i](#)

5.3.1 Protein backbone [i](#)

In the following table, the Percentiles column shows the percent Ramachandran outliers of the chain as a percentile score with respect to all X-ray entries followed by that with respect to entries of similar resolution.

The Analysed column shows the number of residues for which the backbone conformation was analysed, and the total number of residues.

Mol	Chain	Analysed	Favoured	Allowed	Outliers	Percentiles	
1	A	348/373 (93%)	346 (99%)	2 (1%)	0	100	100
1	B	357/373 (96%)	354 (99%)	3 (1%)	0	100	100
1	C	351/373 (94%)	346 (99%)	5 (1%)	0	100	100
1	D	359/373 (96%)	357 (99%)	2 (1%)	0	100	100
1	E	350/373 (94%)	346 (99%)	4 (1%)	0	100	100
1	F	357/373 (96%)	354 (99%)	3 (1%)	0	100	100
1	G	351/373 (94%)	347 (99%)	4 (1%)	0	100	100
1	H	357/373 (96%)	357 (100%)	0	0	100	100
All	All	2830/2984 (95%)	2807 (99%)	23 (1%)	0	100	100

There are no Ramachandran outliers to report.

5.3.2 Protein sidechains [i](#)

In the following table, the Percentiles column shows the percent sidechain outliers of the chain as a percentile score with respect to all X-ray entries followed by that with respect to entries of similar resolution.

The Analysed column shows the number of residues for which the sidechain conformation was analysed, and the total number of residues.

Mol	Chain	Analysed	Rotameric	Outliers	Percentiles	
1	A	293/312 (94%)	285 (97%)	8 (3%)	44	71
1	B	300/312 (96%)	289 (96%)	11 (4%)	34	60
1	C	295/312 (95%)	283 (96%)	12 (4%)	30	55
1	D	301/312 (96%)	287 (95%)	14 (5%)	26	49
1	E	294/312 (94%)	288 (98%)	6 (2%)	55	79
1	F	300/312 (96%)	286 (95%)	14 (5%)	26	49

Continued on next page...

Continued from previous page...

Mol	Chain	Analysed	Rotameric	Outliers	Percentiles
1	G	295/312 (95%)	287 (97%)	8 (3%)	44 71
1	H	300/312 (96%)	287 (96%)	13 (4%)	29 53
All	All	2378/2496 (95%)	2292 (96%)	86 (4%)	35 61

All (86) residues with a non-rotameric sidechain are listed below:

Mol	Chain	Res	Type
1	A	81	LEU
1	A	109	SER
1	A	123	ARG
1	A	150	GLU
1	A	320	HIS
1	A	325	PHE
1	A	343	MET
1	A	349	THR
1	B	81	LEU
1	B	101	ASP
1	B	109	SER
1	B	150	GLU
1	B	241	THR
1	B	287	ASP
1	B	301	ARG
1	B	308	ARG
1	B	315	LYS
1	B	320	HIS
1	B	325	PHE
1	C	53	GLU
1	C	81	LEU
1	C	105	GLN
1	C	150	GLU
1	C	237	GLU
1	C	309	VAL
1	C	320	HIS
1	C	325	PHE
1	C	343	MET
1	C	348	VAL
1	C	350	ILE
1	C	352	GLU
1	D	-3[A]	ARG
1	D	-3[B]	ARG
1	D	24	THR

Continued on next page...

Continued from previous page...

Mol	Chain	Res	Type
1	D	38	LEU
1	D	46	LEU
1	D	81	LEU
1	D	101	ASP
1	D	105	GLN
1	D	109	SER
1	D	150	GLU
1	D	287	ASP
1	D	314	SER
1	D	320	HIS
1	D	325	PHE
1	E	81	LEU
1	E	193	LEU
1	E	309	VAL
1	E	320	HIS
1	E	325	PHE
1	E	350	ILE
1	F	-3	ARG
1	F	24	THR
1	F	46	LEU
1	F	81	LEU
1	F	101	ASP
1	F	109	SER
1	F	150	GLU
1	F	241	THR
1	F	287	ASP
1	F	314	SER
1	F	315	LYS
1	F	320	HIS
1	F	325	PHE
1	F	349	THR
1	G	81	LEU
1	G	123	ARG
1	G	287	ASP
1	G	305	THR
1	G	320	HIS
1	G	325	PHE
1	G	343	MET
1	G	348	VAL
1	H	-3	ARG
1	H	24	THR
1	H	46	LEU

Continued on next page...

Continued from previous page...

Mol	Chain	Res	Type
1	H	81	LEU
1	H	101	ASP
1	H	109	SER
1	H	188	GLN
1	H	194	ARG
1	H	241	THR
1	H	287	ASP
1	H	314	SER
1	H	320	HIS
1	H	325	PHE

Sometimes sidechains can be flipped to improve hydrogen bonding and reduce clashes. All (9) such sidechains are listed below:

Mol	Chain	Res	Type
1	A	288	GLN
1	B	105	GLN
1	C	288	GLN
1	D	105	GLN
1	E	105	GLN
1	E	288	GLN
1	F	105	GLN
1	G	105	GLN
1	G	288	GLN

5.3.3 RNA [i](#)

There are no RNA molecules in this entry.

5.4 Non-standard residues in protein, DNA, RNA chains [i](#)

There are no non-standard protein/DNA/RNA residues in this entry.

5.5 Carbohydrates [i](#)

There are no monosaccharides in this entry.

5.6 Ligand geometry [i](#)

16 ligands are modelled in this entry.

In the following table, the Counts columns list the number of bonds (or angles) for which Mogul statistics could be retrieved, the number of bonds (or angles) that are observed in the model and the number of bonds (or angles) that are defined in the Chemical Component Dictionary. The Link column lists molecule types, if any, to which the group is linked. The Z score for a bond length (or angle) is the number of standard deviations the observed value is removed from the expected value. A bond length (or angle) with $|Z| > 2$ is considered an outlier worth inspection. RMSZ is the root-mean-square of all Z scores of the bond lengths (or angles).

Mol	Type	Chain	Res	Link	Bond lengths			Bond angles		
					Counts	RMSZ	# Z > 2	Counts	RMSZ	# Z > 2
2	HEM	A	354	3,1	41,50,50	1.84	5 (12%)	45,82,82	1.85	9 (20%)
2	HEM	B	354	3,1	41,50,50	1.94	8 (19%)	45,82,82	1.71	9 (20%)
2	HEM	C	354	3,1	41,50,50	1.85	5 (12%)	45,82,82	1.81	9 (20%)
3	BXO	E	355	2	5,5,5	2.19	2 (40%)	2,4,4	4.95	1 (50%)
2	HEM	E	354	3,1	41,50,50	1.87	6 (14%)	45,82,82	1.84	7 (15%)
2	HEM	D	354	3,1	41,50,50	1.90	6 (14%)	45,82,82	1.75	9 (20%)
3	BXO	F	355	2	5,5,5	1.76	1 (20%)	2,4,4	4.05	1 (50%)
2	HEM	F	354	3,1	41,50,50	1.95	8 (19%)	45,82,82	1.79	8 (17%)
2	HEM	H	354	3,1	41,50,50	1.89	7 (17%)	45,82,82	1.67	10 (22%)
3	BXO	D	355	2	5,5,5	1.91	2 (40%)	2,4,4	4.37	1 (50%)
3	BXO	G	355	2	5,5,5	2.07	2 (40%)	2,4,4	4.84	1 (50%)
2	HEM	G	354	3,1	41,50,50	1.86	5 (12%)	45,82,82	1.81	8 (17%)
3	BXO	H	355	2	5,5,5	1.64	1 (20%)	2,4,4	4.30	1 (50%)
3	BXO	A	355	2	5,5,5	1.34	1 (20%)	2,4,4	7.43	1 (50%)
3	BXO	C	355	2	5,5,5	2.24	2 (40%)	2,4,4	5.67	1 (50%)
3	BXO	B	355	2	5,5,5	1.75	1 (20%)	2,4,4	4.56	1 (50%)

In the following table, the Chirals column lists the number of chiral outliers, the number of chiral centers analysed, the number of these observed in the model and the number defined in the Chemical Component Dictionary. Similar counts are reported in the Torsion and Rings columns. '-' means no outliers of that kind were identified.

Mol	Type	Chain	Res	Link	Chirals	Torsions	Rings
2	HEM	A	354	3,1	-	6/12/54/54	-
2	HEM	B	354	3,1	-	6/12/54/54	-
2	HEM	C	354	3,1	-	6/12/54/54	-
3	BXO	E	355	2	-	0/2/3/3	-
2	HEM	E	354	3,1	-	6/12/54/54	-
2	HEM	D	354	3,1	-	6/12/54/54	-
3	BXO	F	355	2	-	1/2/3/3	-

Continued on next page...

Continued from previous page...

Mol	Type	Chain	Res	Link	Chirals	Torsions	Rings
2	HEM	F	354	3,1	-	6/12/54/54	-
2	HEM	H	354	3,1	-	6/12/54/54	-
3	BXO	D	355	2	-	1/2/3/3	-
3	BXO	G	355	2	-	0/2/3/3	-
2	HEM	G	354	3,1	-	6/12/54/54	-
3	BXO	H	355	2	-	1/2/3/3	-
3	BXO	A	355	2	-	0/2/3/3	-
3	BXO	C	355	2	-	0/2/3/3	-
3	BXO	B	355	2	-	1/2/3/3	-

All (62) bond length outliers are listed below:

Mol	Chain	Res	Type	Atoms	Z	Observed(Å)	Ideal(Å)
2	E	354	HEM	C3D-C2D	7.64	1.53	1.36
2	C	354	HEM	C3D-C2D	7.62	1.52	1.36
2	G	354	HEM	C3D-C2D	7.54	1.52	1.36
2	A	354	HEM	C3D-C2D	7.47	1.52	1.36
2	B	354	HEM	C3D-C2D	7.41	1.52	1.36
2	F	354	HEM	C3D-C2D	7.40	1.52	1.36
2	H	354	HEM	C3D-C2D	7.28	1.52	1.36
2	D	354	HEM	C3D-C2D	7.19	1.52	1.36
2	E	354	HEM	C3C-C2C	-4.54	1.34	1.40
2	C	354	HEM	C3C-C2C	-4.42	1.34	1.40
2	G	354	HEM	C3C-C2C	-4.37	1.34	1.40
2	A	354	HEM	C3C-C2C	-4.37	1.34	1.40
3	C	355	BXO	C2-C1	4.35	1.53	1.49
3	E	355	BXO	C2-C1	4.26	1.53	1.49
2	D	354	HEM	C3C-C2C	-4.13	1.34	1.40
2	B	354	HEM	C3C-C2C	-4.03	1.34	1.40
2	F	354	HEM	C3C-CAC	3.97	1.55	1.47
2	F	354	HEM	C3C-C2C	-3.91	1.34	1.40
2	H	354	HEM	C3C-C2C	-3.90	1.35	1.40
2	H	354	HEM	C3C-CAC	3.85	1.55	1.47
3	G	355	BXO	C2-C1	3.83	1.52	1.49
3	D	355	BXO	C2-C1	3.68	1.52	1.49
2	B	354	HEM	C3C-CAC	3.67	1.55	1.47
2	D	354	HEM	C3C-CAC	3.64	1.55	1.47
3	F	355	BXO	C2-C1	3.37	1.52	1.49
3	B	355	BXO	C2-C1	3.29	1.52	1.49
3	H	355	BXO	C2-C1	3.21	1.52	1.49
2	C	354	HEM	C3C-CAC	3.16	1.54	1.47
2	A	354	HEM	C3C-CAC	3.11	1.54	1.47

Continued on next page...

Continued from previous page...

Mol	Chain	Res	Type	Atoms	Z	Observed(Å)	Ideal(Å)
2	E	354	HEM	C3C-CAC	3.09	1.54	1.47
2	B	354	HEM	CAB-C3B	3.08	1.55	1.47
2	D	354	HEM	CAB-C3B	2.91	1.55	1.47
2	G	354	HEM	C3C-CAC	2.90	1.53	1.47
2	E	354	HEM	CAB-C3B	2.87	1.55	1.47
3	A	355	BXO	C2-C1	2.85	1.51	1.49
2	A	354	HEM	CAB-C3B	2.83	1.55	1.47
2	H	354	HEM	CAB-C3B	2.83	1.55	1.47
2	F	354	HEM	CAB-C3B	2.78	1.55	1.47
2	G	354	HEM	CAB-C3B	2.78	1.55	1.47
2	C	354	HEM	CAB-C3B	2.72	1.54	1.47
3	G	355	BXO	C1-N1	2.55	1.28	1.26
2	H	354	HEM	CMB-C2B	2.54	1.56	1.50
2	F	354	HEM	CMB-C2B	2.47	1.56	1.50
2	B	354	HEM	CMB-C2B	2.46	1.56	1.50
3	C	355	BXO	C1-N1	2.45	1.28	1.26
3	E	355	BXO	C1-N1	2.38	1.28	1.26
2	D	354	HEM	CMB-C2B	2.38	1.55	1.50
2	B	354	HEM	CAA-C2A	2.34	1.55	1.52
2	A	354	HEM	CMB-C2B	2.29	1.55	1.50
2	G	354	HEM	CMB-C2B	2.24	1.55	1.50
2	H	354	HEM	FE-NB	2.23	2.07	1.96
2	D	354	HEM	CAA-C2A	2.21	1.55	1.52
2	F	354	HEM	CMD-C2D	2.17	1.55	1.50
2	B	354	HEM	CMC-C2C	2.17	1.56	1.51
2	H	354	HEM	CAA-C2A	2.15	1.55	1.52
2	E	354	HEM	CMB-C2B	2.12	1.55	1.50
2	C	354	HEM	CMB-C2B	2.12	1.55	1.50
3	D	355	BXO	C1-N1	2.10	1.28	1.26
2	B	354	HEM	CAD-C3D	2.07	1.56	1.51
2	F	354	HEM	CMA-C3A	2.07	1.55	1.51
2	F	354	HEM	CAD-C3D	2.02	1.56	1.51
2	E	354	HEM	CMA-C3A	2.01	1.55	1.51

All (77) bond angle outliers are listed below:

Mol	Chain	Res	Type	Atoms	Z	Observed(°)	Ideal(°)
3	A	355	BXO	O1-N1-C1	10.51	121.55	111.70
3	C	355	BXO	O1-N1-C1	8.02	119.22	111.70
3	E	355	BXO	O1-N1-C1	7.00	118.26	111.70
3	G	355	BXO	O1-N1-C1	6.84	118.12	111.70
2	F	354	HEM	C4D-ND-C1D	6.60	111.89	105.07

Continued on next page...

Continued from previous page...

Mol	Chain	Res	Type	Atoms	Z	Observed(°)	Ideal(°)
3	B	355	BXO	O1-N1-C1	6.44	117.74	111.70
2	D	354	HEM	C4D-ND-C1D	6.26	111.54	105.07
2	B	354	HEM	C4D-ND-C1D	6.22	111.50	105.07
3	D	355	BXO	O1-N1-C1	6.16	117.48	111.70
2	G	354	HEM	C4D-ND-C1D	6.11	111.39	105.07
2	E	354	HEM	C4D-ND-C1D	6.08	111.36	105.07
3	H	355	BXO	O1-N1-C1	6.07	117.39	111.70
2	H	354	HEM	C4D-ND-C1D	6.03	111.30	105.07
2	A	354	HEM	C4D-ND-C1D	6.00	111.28	105.07
2	C	354	HEM	C4D-ND-C1D	6.00	111.27	105.07
2	C	354	HEM	CBA-CAA-C2A	-5.75	102.81	112.62
2	A	354	HEM	CBA-CAA-C2A	-5.71	102.88	112.62
3	F	355	BXO	O1-N1-C1	5.70	117.05	111.70
2	E	354	HEM	CBA-CAA-C2A	-5.64	102.99	112.62
2	G	354	HEM	CBA-CAA-C2A	-5.59	103.07	112.62
2	F	354	HEM	C4C-CHD-C1D	3.91	127.72	122.56
2	D	354	HEM	C4C-CHD-C1D	3.58	127.28	122.56
2	F	354	HEM	CAD-C3D-C4D	3.45	130.69	124.66
2	D	354	HEM	CAD-C3D-C4D	3.40	130.60	124.66
2	H	354	HEM	CAD-C3D-C4D	3.31	130.44	124.66
2	B	354	HEM	CAD-C3D-C4D	3.28	130.40	124.66
2	B	354	HEM	C4C-CHD-C1D	3.24	126.84	122.56
2	H	354	HEM	C4C-CHD-C1D	3.05	126.58	122.56
2	A	354	HEM	CAD-CBD-CGD	-2.83	107.51	113.60
2	A	354	HEM	C1B-NB-C4B	2.80	107.96	105.07
2	G	354	HEM	CAD-CBD-CGD	-2.77	107.65	113.60
2	G	354	HEM	C4B-CHC-C1C	2.73	126.16	122.56
2	C	354	HEM	CAD-CBD-CGD	-2.69	107.81	113.60
2	G	354	HEM	C1B-NB-C4B	2.69	107.85	105.07
2	D	354	HEM	C4B-CHC-C1C	2.65	126.06	122.56
2	B	354	HEM	C4B-CHC-C1C	2.61	126.00	122.56
2	E	354	HEM	C4B-CHC-C1C	2.59	125.97	122.56
2	E	354	HEM	CAD-CBD-CGD	-2.58	108.05	113.60
2	E	354	HEM	C1B-NB-C4B	2.57	107.72	105.07
2	D	354	HEM	CAA-CBA-CGA	-2.52	106.69	113.76
2	F	354	HEM	C4B-CHC-C1C	2.50	125.86	122.56
2	C	354	HEM	C1B-NB-C4B	2.47	107.63	105.07
2	F	354	HEM	C1B-NB-C4B	2.46	107.62	105.07
2	A	354	HEM	C4B-CHC-C1C	2.44	125.77	122.56
2	F	354	HEM	CAA-CBA-CGA	-2.39	107.05	113.76
2	F	354	HEM	CMD-C2D-C1D	2.36	128.63	125.04
2	C	354	HEM	CAD-C3D-C4D	2.34	128.75	124.66

Continued on next page...

Continued from previous page...

Mol	Chain	Res	Type	Atoms	Z	Observed(°)	Ideal(°)
2	E	354	HEM	CAD-C3D-C4D	2.33	128.74	124.66
2	D	354	HEM	C1B-NB-C4B	2.30	107.45	105.07
2	F	354	HEM	C4D-C3D-C2D	-2.29	103.55	106.90
2	D	354	HEM	CMD-C2D-C1D	2.26	128.49	125.04
2	E	354	HEM	CMD-C2D-C1D	2.26	128.49	125.04
2	A	354	HEM	C2C-C3C-C4C	2.26	108.48	106.90
2	H	354	HEM	CAA-CBA-CGA	-2.26	107.42	113.76
2	B	354	HEM	CAA-CBA-CGA	-2.25	107.44	113.76
2	A	354	HEM	CAD-C3D-C4D	2.25	128.59	124.66
2	D	354	HEM	C4D-C3D-C2D	-2.25	103.62	106.90
2	H	354	HEM	C1B-NB-C4B	2.24	107.39	105.07
2	G	354	HEM	C2C-C3C-C4C	2.23	108.45	106.90
2	G	354	HEM	CMD-C2D-C1D	2.23	128.43	125.04
2	H	354	HEM	C4B-CHC-C1C	2.22	125.49	122.56
2	B	354	HEM	CMD-C2D-C1D	2.21	128.40	125.04
2	B	354	HEM	C4D-C3D-C2D	-2.19	103.71	106.90
2	B	354	HEM	C1B-NB-C4B	2.18	107.33	105.07
2	C	354	HEM	CMD-C2D-C1D	2.17	128.35	125.04
2	A	354	HEM	CMD-C2D-C1D	2.16	128.33	125.04
2	H	354	HEM	C4D-C3D-C2D	-2.15	103.76	106.90
2	C	354	HEM	C2C-C3C-C4C	2.14	108.39	106.90
2	C	354	HEM	C4B-CHC-C1C	2.12	125.36	122.56
2	H	354	HEM	CHC-C4B-NB	2.10	126.71	124.43
2	G	354	HEM	CAD-C3D-C4D	2.09	128.31	124.66
2	A	354	HEM	C2B-C1B-NB	-2.05	107.42	109.84
2	C	354	HEM	C4C-CHD-C1D	2.04	125.25	122.56
2	H	354	HEM	CMD-C2D-C1D	2.03	128.13	125.04
2	B	354	HEM	CMA-C3A-C4A	-2.02	125.36	128.46
2	D	354	HEM	CMA-C3A-C4A	-2.01	125.37	128.46
2	H	354	HEM	CMA-C3A-C4A	-2.00	125.39	128.46

There are no chirality outliers.

All (52) torsion outliers are listed below:

Mol	Chain	Res	Type	Atoms
2	A	354	HEM	C2B-C3B-CAB-CBB
2	A	354	HEM	C4B-C3B-CAB-CBB
2	B	354	HEM	C2B-C3B-CAB-CBB
2	C	354	HEM	C2B-C3B-CAB-CBB
2	C	354	HEM	C4B-C3B-CAB-CBB
2	D	354	HEM	C2B-C3B-CAB-CBB
2	E	354	HEM	C2B-C3B-CAB-CBB

Continued on next page...

Continued from previous page...

Mol	Chain	Res	Type	Atoms
2	E	354	HEM	C4B-C3B-CAB-CBB
2	F	354	HEM	C2B-C3B-CAB-CBB
2	G	354	HEM	C2B-C3B-CAB-CBB
2	G	354	HEM	C4B-C3B-CAB-CBB
2	H	354	HEM	C2B-C3B-CAB-CBB
3	B	355	BXO	C1-C2-C3-C4
3	D	355	BXO	C1-C2-C3-C4
3	F	355	BXO	C1-C2-C3-C4
3	H	355	BXO	C1-C2-C3-C4
2	B	354	HEM	C4B-C3B-CAB-CBB
2	D	354	HEM	C4B-C3B-CAB-CBB
2	F	354	HEM	C4B-C3B-CAB-CBB
2	H	354	HEM	C4B-C3B-CAB-CBB
2	G	354	HEM	CAA-CBA-CGA-O2A
2	A	354	HEM	CAA-CBA-CGA-O2A
2	C	354	HEM	CAA-CBA-CGA-O2A
2	E	354	HEM	CAA-CBA-CGA-O2A
2	D	354	HEM	CAA-CBA-CGA-O1A
2	F	354	HEM	CAA-CBA-CGA-O1A
2	H	354	HEM	CAA-CBA-CGA-O1A
2	D	354	HEM	CAA-CBA-CGA-O2A
2	B	354	HEM	CAA-CBA-CGA-O1A
2	F	354	HEM	CAA-CBA-CGA-O2A
2	F	354	HEM	CAD-CBD-CGD-O1D
2	H	354	HEM	CAD-CBD-CGD-O1D
2	B	354	HEM	CAD-CBD-CGD-O1D
2	F	354	HEM	CAD-CBD-CGD-O2D
2	B	354	HEM	CAD-CBD-CGD-O2D
2	B	354	HEM	CAA-CBA-CGA-O2A
2	D	354	HEM	CAD-CBD-CGD-O1D
2	H	354	HEM	CAA-CBA-CGA-O2A
2	H	354	HEM	CAD-CBD-CGD-O2D
2	D	354	HEM	CAD-CBD-CGD-O2D
2	C	354	HEM	CAA-CBA-CGA-O1A
2	A	354	HEM	CAA-CBA-CGA-O1A
2	G	354	HEM	CAA-CBA-CGA-O1A
2	E	354	HEM	CAA-CBA-CGA-O1A
2	C	354	HEM	CAD-CBD-CGD-O2D
2	A	354	HEM	CAD-CBD-CGD-O2D
2	E	354	HEM	CAD-CBD-CGD-O2D
2	G	354	HEM	CAD-CBD-CGD-O2D
2	C	354	HEM	CAD-CBD-CGD-O1D

Continued on next page...

Continued from previous page...

Mol	Chain	Res	Type	Atoms
2	A	354	HEM	CAD-CBD-CGD-O1D
2	E	354	HEM	CAD-CBD-CGD-O1D
2	G	354	HEM	CAD-CBD-CGD-O1D

There are no ring outliers.

14 monomers are involved in 29 short contacts:

Mol	Chain	Res	Type	Clashes	Symm-Clashes
2	A	354	HEM	4	0
2	B	354	HEM	2	0
2	C	354	HEM	4	0
2	E	354	HEM	4	0
2	D	354	HEM	1	0
3	F	355	BXO	1	0
2	F	354	HEM	2	0
2	H	354	HEM	3	0
3	D	355	BXO	1	0
3	G	355	BXO	1	0
2	G	354	HEM	4	0
3	H	355	BXO	3	0
3	A	355	BXO	2	0
3	B	355	BXO	1	0

The following is a two-dimensional graphical depiction of Mogul quality analysis of bond lengths, bond angles, torsion angles, and ring geometry for all instances of the Ligand of Interest. In addition, ligands with molecular weight > 250 and outliers as shown on the validation Tables will also be included. For torsion angles, if less than 5% of the Mogul distribution of torsion angles is within 10 degrees of the torsion angle in question, then that torsion angle is considered an outlier. Any bond that is central to one or more torsion angles identified as an outlier by Mogul will be highlighted in the graph. For rings, the root-mean-square deviation (RMSD) between the ring in question and similar rings identified by Mogul is calculated over all ring torsion angles. If the average RMSD is greater than 60 degrees and the minimal RMSD between the ring in question and any Mogul-identified rings is also greater than 60 degrees, then that ring is considered an outlier. The outliers are highlighted in purple. The color gray indicates Mogul did not find sufficient equivalents in the CSD to analyse the geometry.

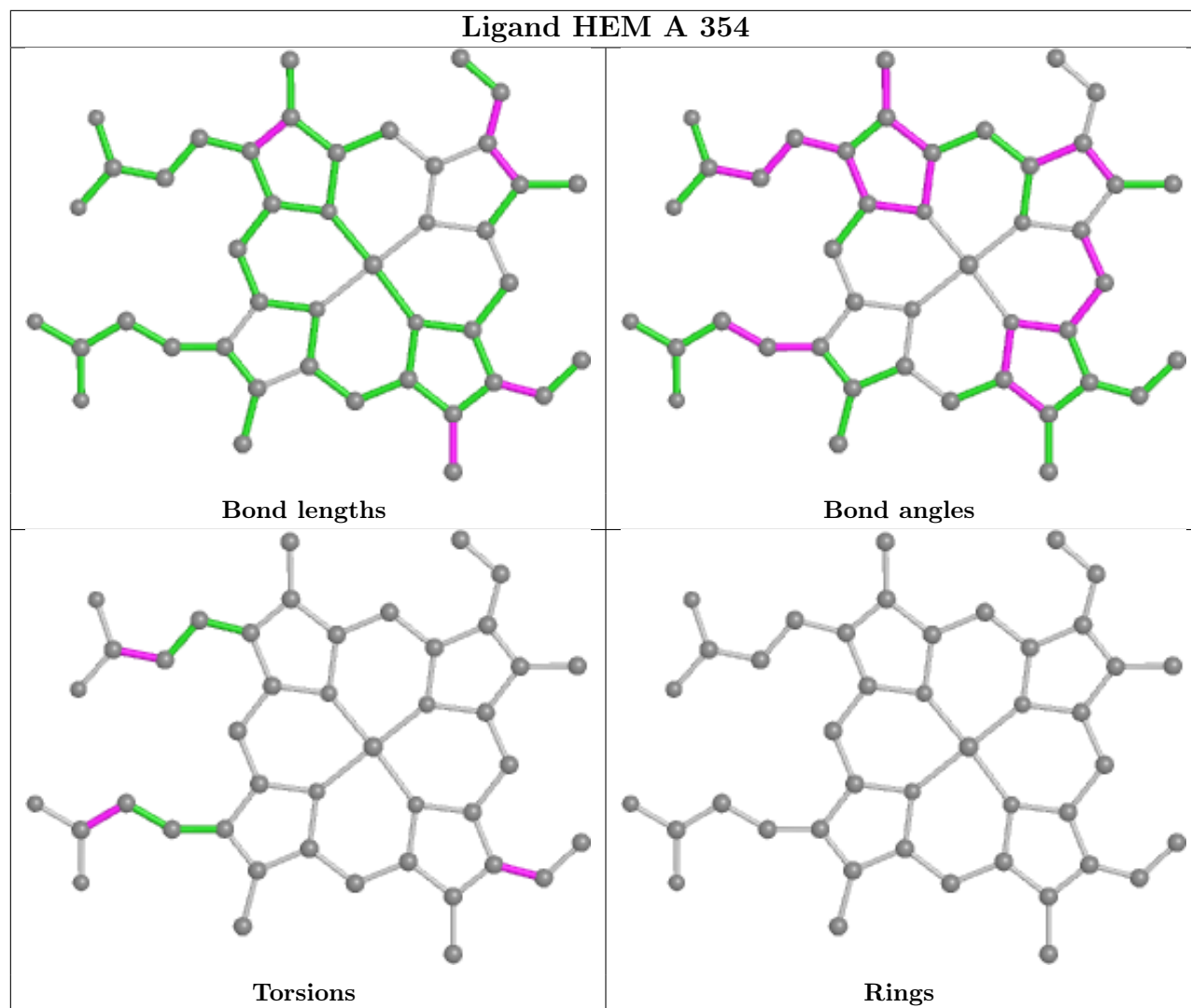

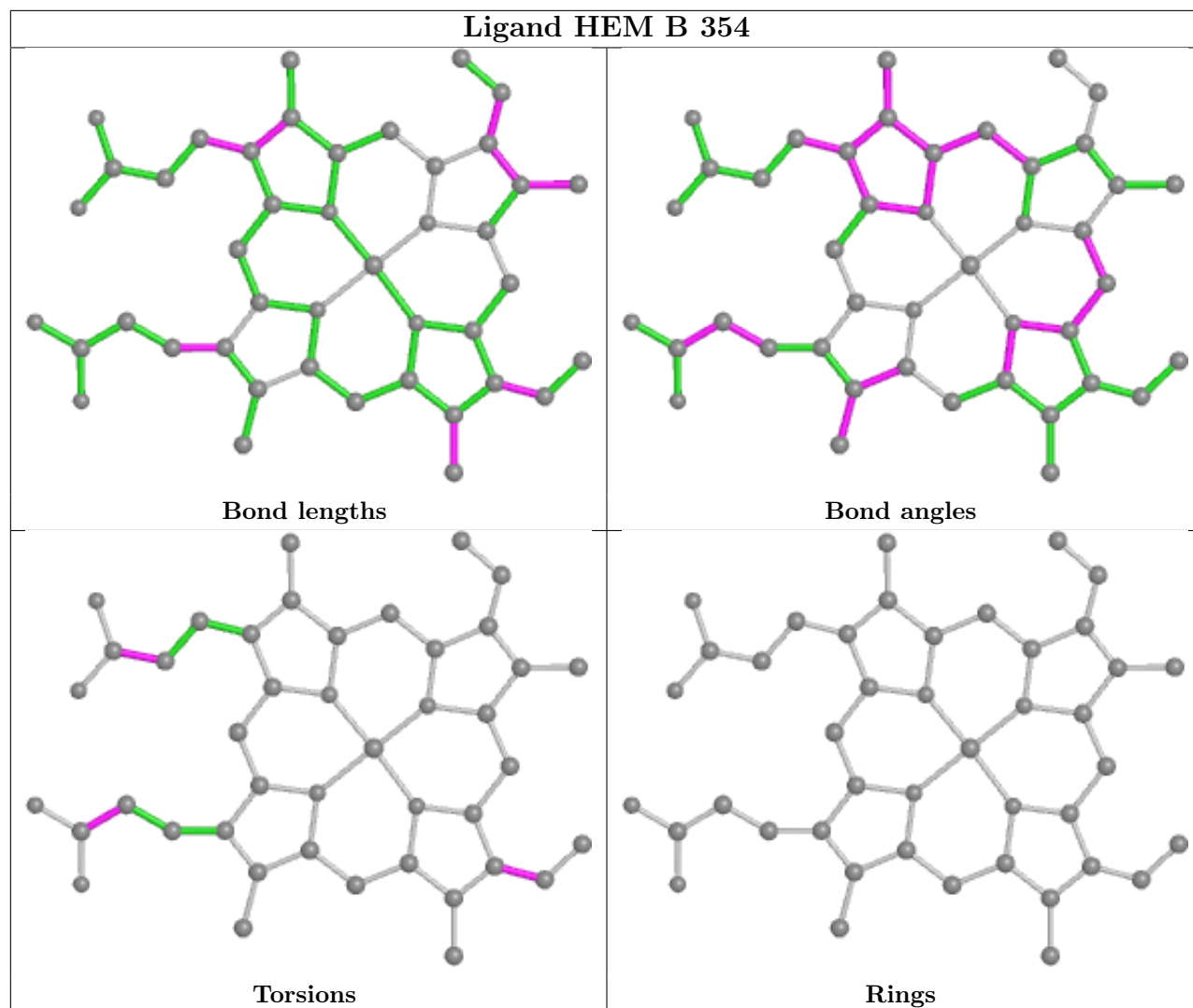

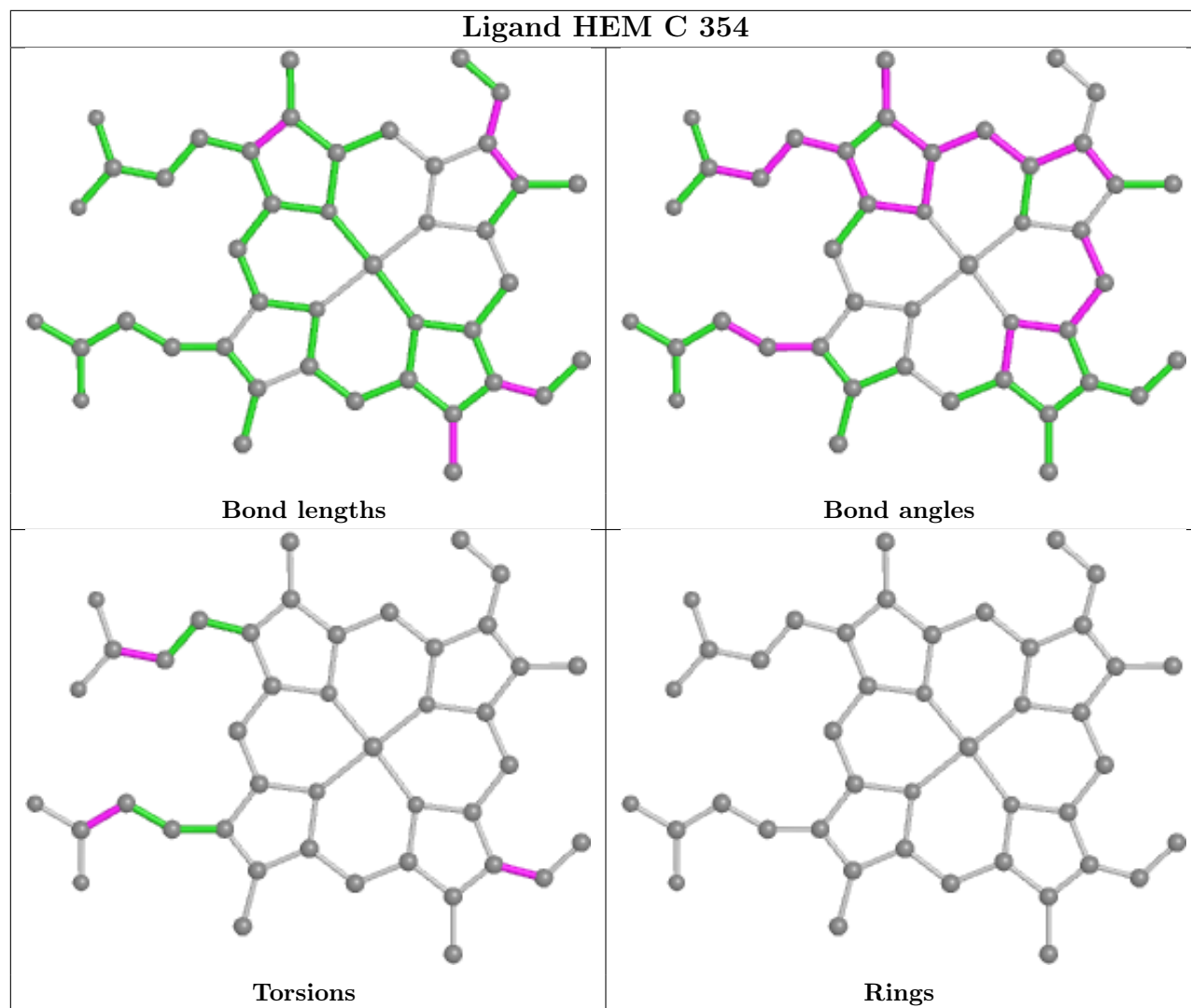

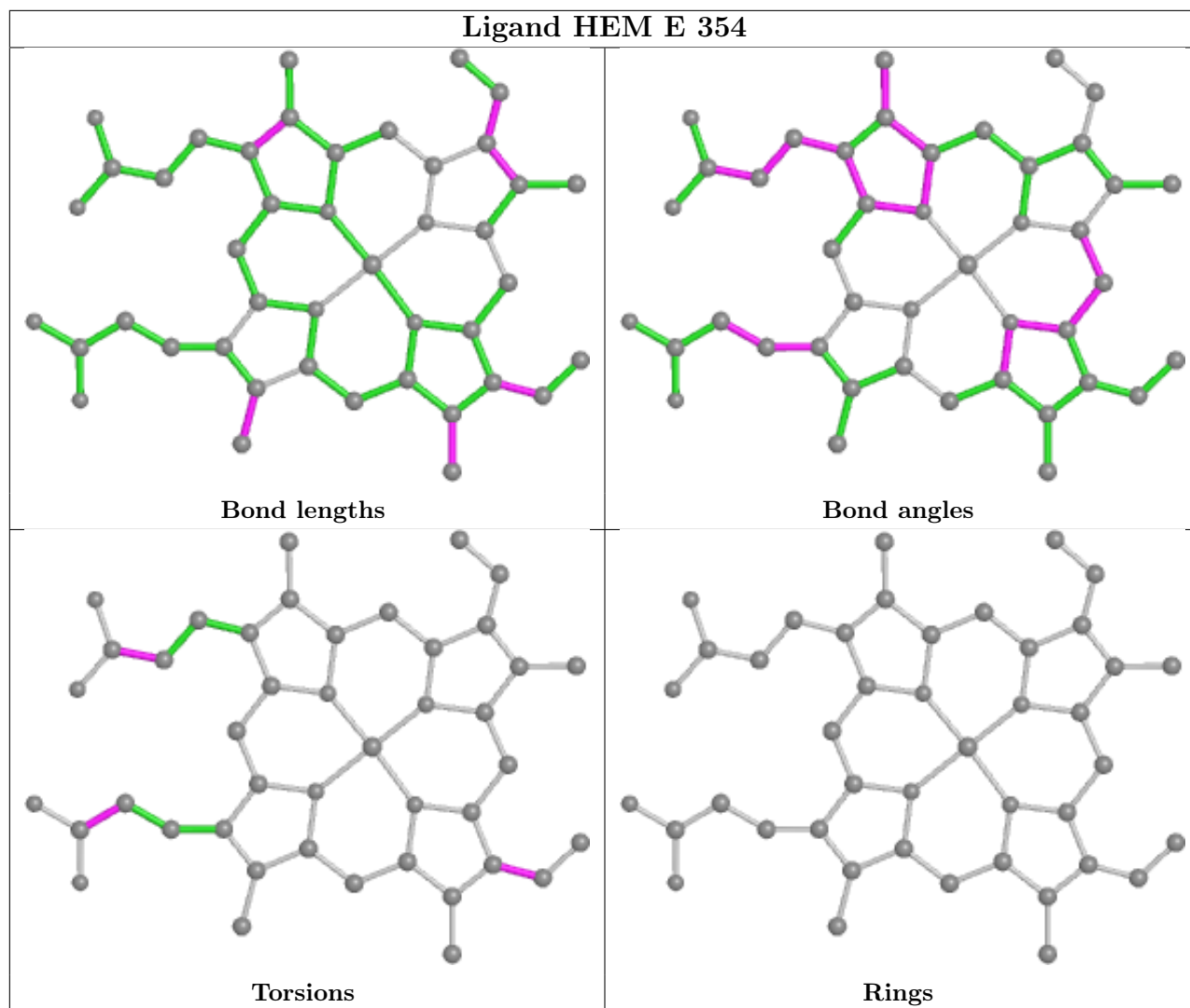

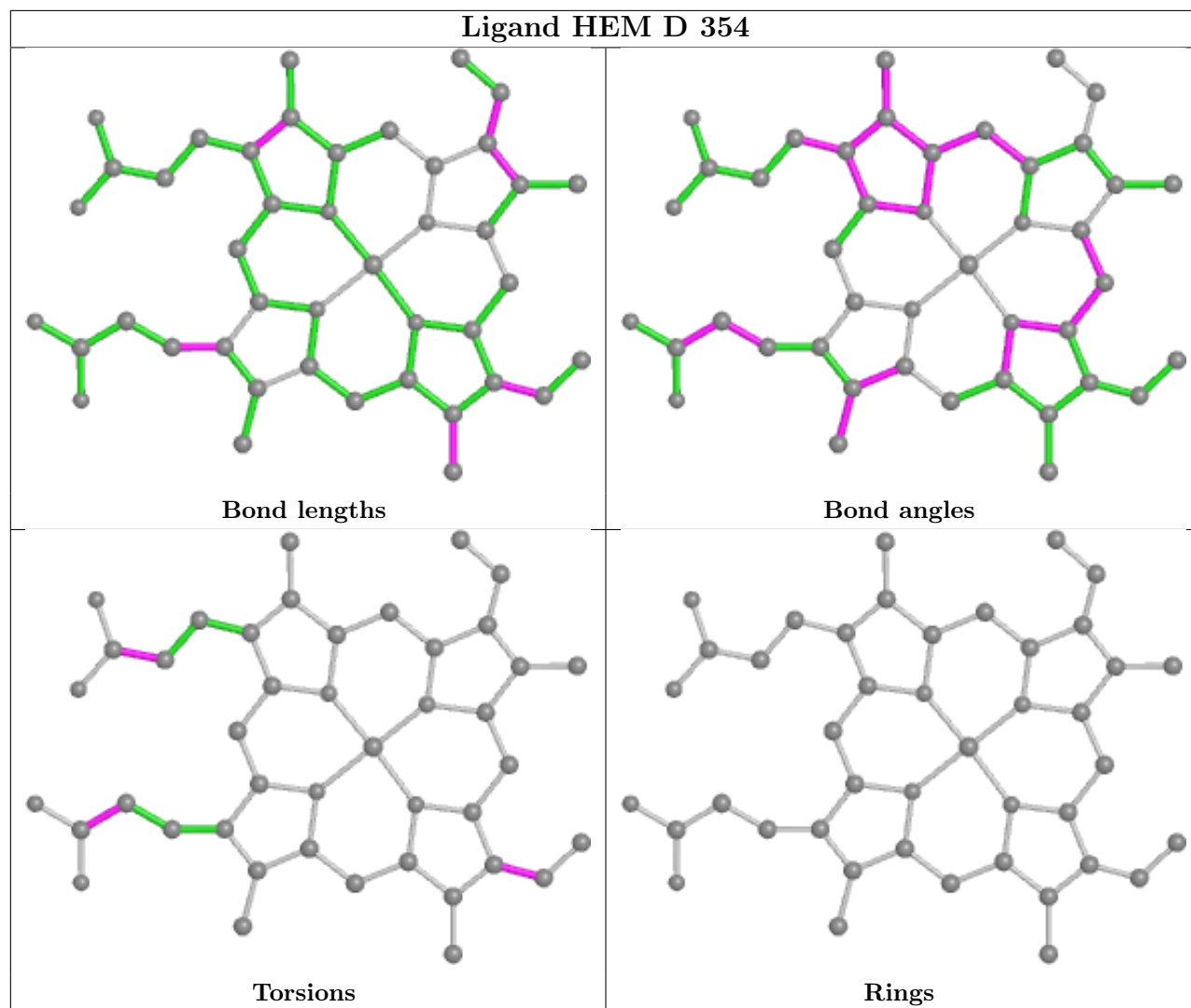

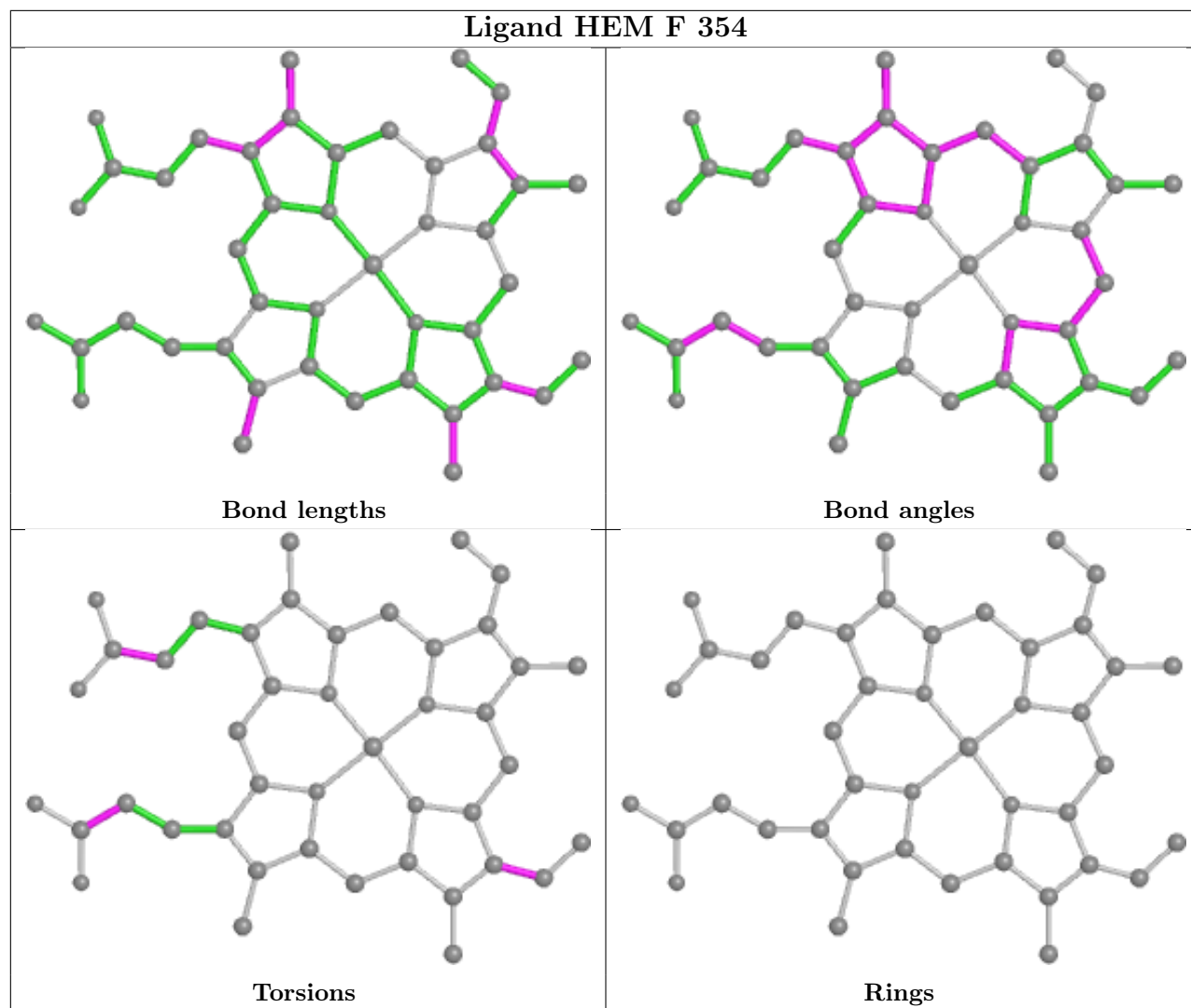

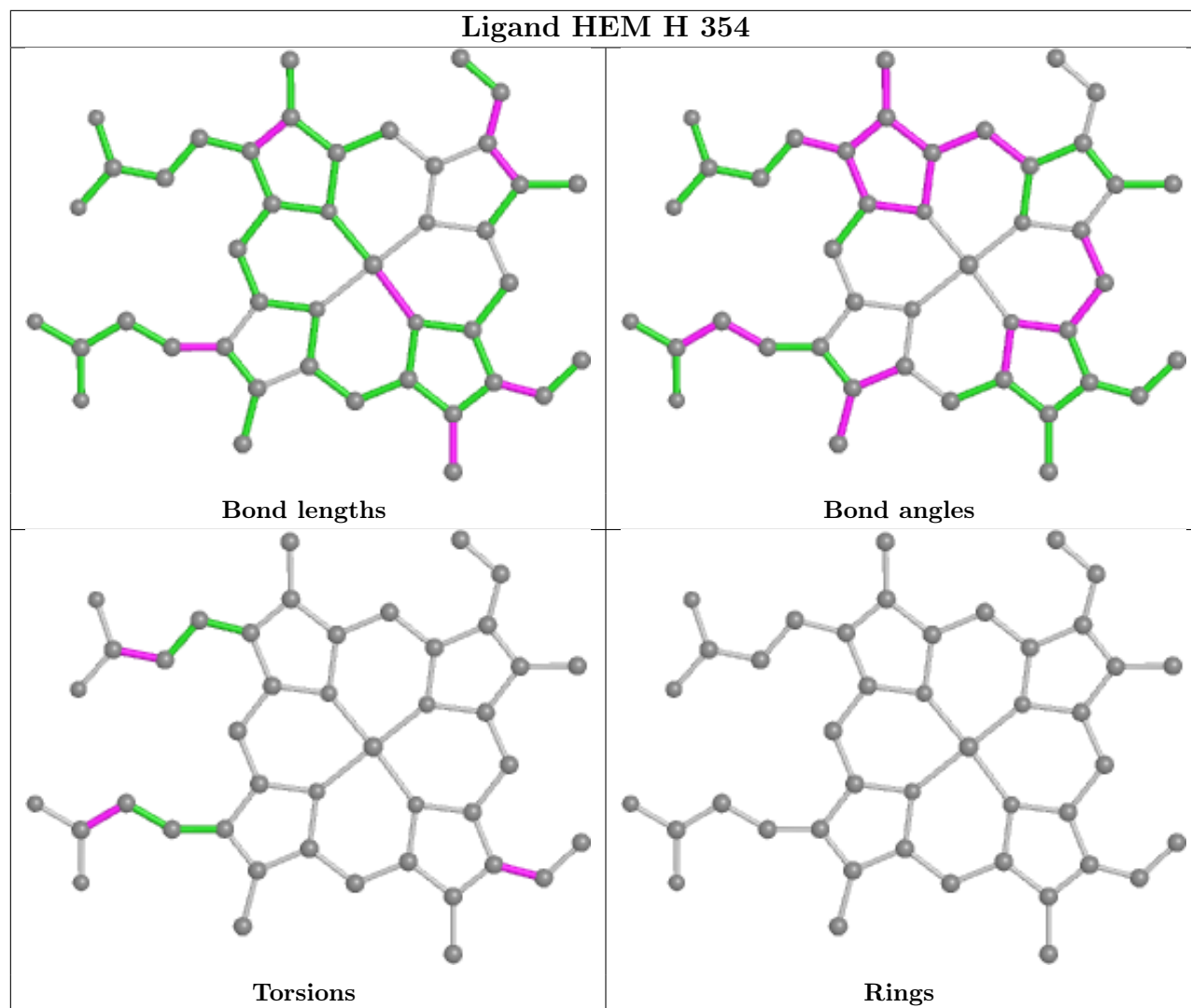

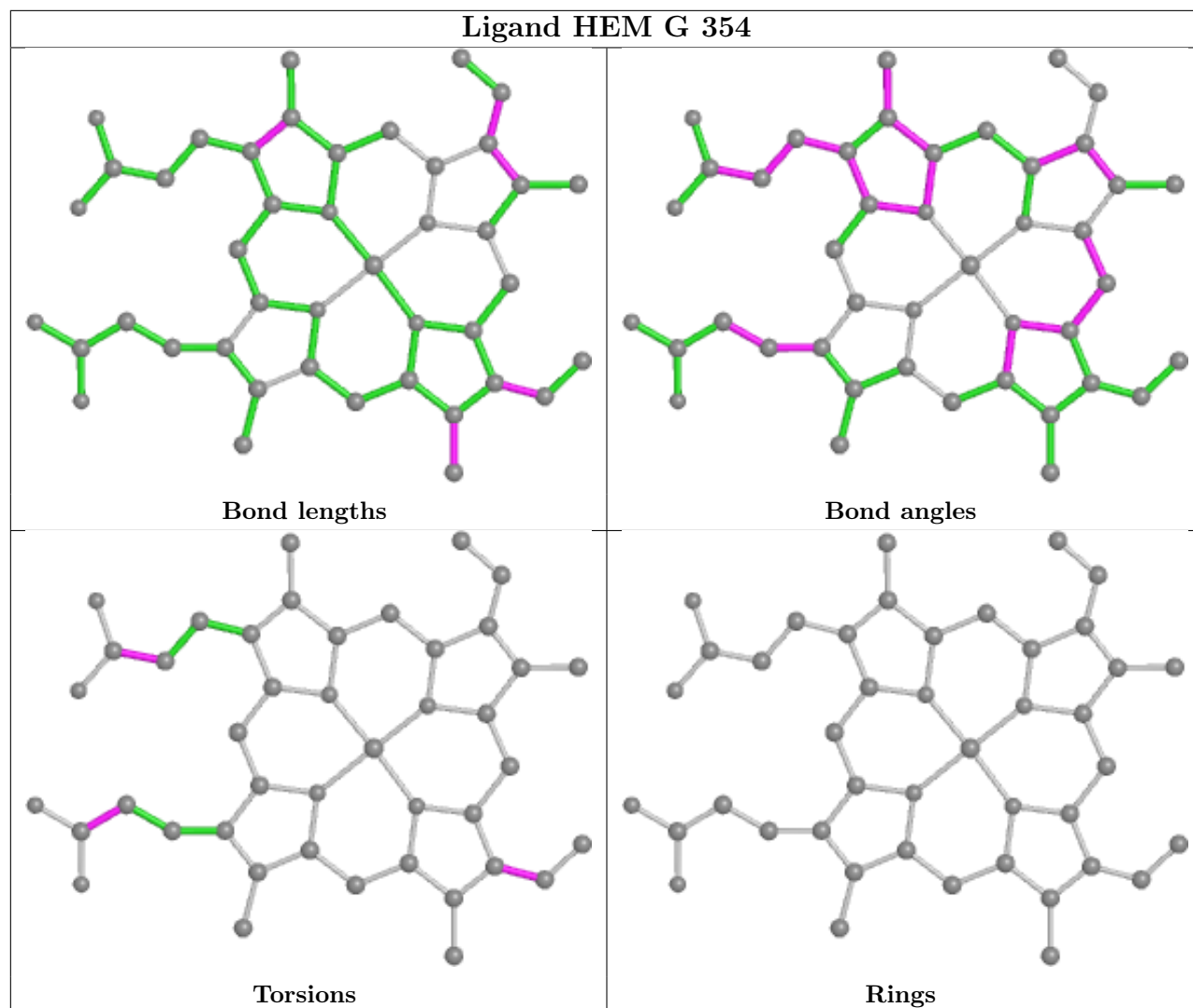

5.7 Other polymers [i](#)

There are no such residues in this entry.

5.8 Polymer linkage issues [i](#)

There are no chain breaks in this entry.

6 Fit of model and data

6.1 Protein, DNA and RNA chains

In the following table, the column labelled ‘#RSRZ > 2’ contains the number (and percentage) of RSRZ outliers, followed by percent RSRZ outliers for the chain as percentile scores relative to all X-ray entries and entries of similar resolution. The OWAB column contains the minimum, median, 95th percentile and maximum values of the occupancy-weighted average B-factor per residue. The column labelled ‘Q < 0.9’ lists the number of (and percentage) of residues with an average occupancy less than 0.9.

Mol	Chain	Analysed	<RSRZ>	#RSRZ>2	OWAB(Å ²)	Q<0.9
1	A	350/373 (93%)	0.35	14 (4%) 38 41	13, 25, 39, 55	0
1	B	359/373 (96%)	0.66	39 (10%) 5 5	15, 31, 57, 67	0
1	C	352/373 (94%)	0.37	23 (6%) 18 19	14, 25, 40, 55	0
1	D	360/373 (96%)	0.63	37 (10%) 6 6	15, 31, 57, 68	0
1	E	351/373 (94%)	0.36	25 (7%) 16 16	14, 25, 40, 55	0
1	F	359/373 (96%)	0.65	42 (11%) 4 4	15, 31, 57, 68	0
1	G	353/373 (94%)	0.38	23 (6%) 18 19	13, 25, 41, 55	0
1	H	359/373 (96%)	0.61	46 (12%) 3 3	15, 31, 57, 68	0
All	All	2843/2984 (95%)	0.50	249 (8%) 10 10	13, 26, 55, 68	0

All (249) RSRZ outliers are listed below:

Mol	Chain	Res	Type	RSRZ
1	G	353	HIS	7.7
1	G	351	ALA	7.0
1	D	350	ILE	6.7
1	F	201	ALA	6.6
1	H	350	ILE	6.6
1	F	350	ILE	6.2
1	B	126	ASP	6.1
1	F	125	SER	6.0
1	C	351	ALA	5.9
1	B	201	ALA	5.9
1	H	75	GLY	5.8
1	E	124	LEU	5.8
1	F	126	ASP	5.7
1	G	121	GLU	5.5
1	E	12	PRO	5.5
1	D	112	THR	5.3

Continued on next page...

Continued from previous page...

Mol	Chain	Res	Type	RSRZ
1	B	350	ILE	5.3
1	A	124	LEU	5.1
1	C	12	PRO	5.0
1	F	127	GLY	4.9
1	G	12	PRO	4.9
1	B	103	SER	4.9
1	F	110	THR	4.9
1	B	125	SER	4.8
1	H	201	ALA	4.7
1	F	121	GLU	4.7
1	B	112	THR	4.7
1	E	125	SER	4.7
1	A	12	PRO	4.6
1	A	125	SER	4.6
1	D	-8	SER	4.5
1	C	311	ALA	4.5
1	E	351	ALA	4.4
1	D	106	HIS	4.4
1	H	202	VAL	4.4
1	H	121	GLU	4.3
1	C	125	SER	4.3
1	C	124	LEU	4.2
1	B	194	ARG	4.2
1	F	122	ASP	4.2
1	D	113	PRO	4.2
1	B	121	GLU	4.1
1	H	106	HIS	3.9
1	B	54	ASP	3.9
1	G	124	LEU	3.8
1	H	126	ASP	3.8
1	H	127	GLY	3.8
1	H	103	SER	3.8
1	H	122	ASP	3.7
1	D	351	ALA	3.7
1	F	74	ASP	3.7
1	A	121	GLU	3.7
1	E	51	ARG	3.6
1	E	21	ASP	3.6
1	D	125	SER	3.6
1	E	121	GLU	3.6
1	F	119	GLU	3.6
1	D	122	ASP	3.6

Continued on next page...

Continued from previous page...

Mol	Chain	Res	Type	RSRZ
1	F	106	HIS	3.5
1	D	150	GLU	3.5
1	F	12	PRO	3.5
1	F	349	THR	3.5
1	D	349	THR	3.5
1	H	125	SER	3.4
1	B	53	GLU	3.4
1	H	194	ARG	3.4
1	G	126	ASP	3.4
1	G	125	SER	3.4
1	F	103	SER	3.4
1	D	201	ALA	3.4
1	B	63	MET	3.4
1	A	112	THR	3.4
1	F	54	ASP	3.4
1	B	73	PRO	3.3
1	E	311	ALA	3.3
1	F	52	ASP	3.3
1	B	122	ASP	3.3
1	H	53	GLU	3.3
1	F	112	THR	3.3
1	A	123	ARG	3.3
1	A	36	ASP	3.2
1	H	349	THR	3.2
1	D	119	GLU	3.2
1	F	-8	SER	3.2
1	D	73	PRO	3.1
1	C	318	LEU	3.1
1	D	121	GLU	3.1
1	F	328	ALA	3.1
1	C	36	ASP	3.1
1	A	311	ALA	3.1
1	H	119	GLU	3.1
1	F	111	SER	3.0
1	E	150	GLU	3.0
1	B	205	ARG	3.0
1	B	12	PRO	3.0
1	D	75	GLY	3.0
1	D	53	GLU	3.0
1	F	73	PRO	3.0
1	D	110	THR	3.0
1	E	126	ASP	2.9

Continued on next page...

Continued from previous page...

Mol	Chain	Res	Type	RSRZ
1	D	72	LEU	2.9
1	D	36	ASP	2.9
1	H	112	THR	2.9
1	B	52	ASP	2.9
1	E	112	THR	2.9
1	H	54	ASP	2.9
1	B	349	THR	2.9
1	B	119	GLU	2.9
1	H	328	ALA	2.8
1	H	52	ASP	2.8
1	B	116	SER	2.8
1	G	1	MET	2.8
1	G	54	ASP	2.8
1	B	72	LEU	2.8
1	H	73	PRO	2.7
1	G	22	THR	2.7
1	F	113	PRO	2.7
1	B	7	GLU	2.7
1	B	269	ILE	2.7
1	C	54	ASP	2.7
1	F	151	ASP	2.7
1	F	196	ILE	2.7
1	F	336	ASN	2.7
1	G	36	ASP	2.7
1	B	202	VAL	2.7
1	H	36	ASP	2.7
1	H	61	GLN	2.7
1	F	53	GLU	2.6
1	E	350	ILE	2.6
1	E	1	MET	2.6
1	A	318	LEU	2.6
1	D	126	ASP	2.6
1	H	110	THR	2.6
1	A	54	ASP	2.6
1	F	51	ARG	2.6
1	E	53	GLU	2.6
1	B	71	ASP	2.6
1	B	128	LEU	2.6
1	F	7	GLU	2.6
1	D	35	ASP	2.6
1	F	35	ASP	2.6
1	F	194	ARG	2.6

Continued on next page...

Continued from previous page...

Mol	Chain	Res	Type	RSRZ
1	G	318	LEU	2.5
1	H	200	PRO	2.5
1	H	151	ASP	2.5
1	H	254	PRO	2.5
1	C	11	CYS	2.5
1	D	339	PRO	2.5
1	B	348	VAL	2.5
1	G	123	ARG	2.5
1	G	116	SER	2.5
1	D	328	ALA	2.5
1	C	122	ASP	2.5
1	D	7	GLU	2.5
1	H	107	ARG	2.5
1	F	347	ALA	2.5
1	H	339	PRO	2.5
1	A	116	SER	2.5
1	C	126	ASP	2.5
1	B	272	ASN	2.5
1	F	118	TRP	2.5
1	D	194	ARG	2.5
1	A	21	ASP	2.5
1	D	54	ASP	2.5
1	B	336	ASN	2.5
1	G	53	GLU	2.5
1	H	118	TRP	2.4
1	C	192	GLU	2.4
1	F	75	GLY	2.4
1	G	311	ALA	2.4
1	F	348	VAL	2.4
1	F	128	LEU	2.4
1	B	36	ASP	2.4
1	C	110	THR	2.4
1	D	14	THR	2.4
1	B	-8	SER	2.4
1	E	122	ASP	2.4
1	E	318	LEU	2.4
1	B	328	ALA	2.4
1	F	0	HIS	2.4
1	D	131	PHE	2.3
1	F	205	ARG	2.3
1	B	190	SER	2.3
1	H	124	LEU	2.3

Continued on next page...

Continued from previous page...

Mol	Chain	Res	Type	RSRZ
1	C	123	ARG	2.3
1	C	121	GLU	2.3
1	B	75	GLY	2.3
1	H	116	SER	2.3
1	C	51	ARG	2.3
1	D	124	LEU	2.3
1	D	151	ASP	2.3
1	H	150	GLU	2.3
1	B	151	ASP	2.3
1	B	127	GLY	2.3
1	E	269	ILE	2.3
1	H	196	ILE	2.3
1	G	21	ASP	2.3
1	F	72	LEU	2.3
1	E	194	ARG	2.2
1	C	1	MET	2.2
1	A	53	GLU	2.2
1	H	199	ASP	2.2
1	G	314	SER	2.2
1	C	57	PRO	2.2
1	D	12	PRO	2.2
1	H	272	ASN	2.2
1	E	36	ASP	2.2
1	H	74	ASP	2.2
1	C	350	ILE	2.2
1	C	53	GLU	2.2
1	D	48	VAL	2.2
1	A	51	ARG	2.2
1	B	117	TRP	2.2
1	D	190	SER	2.2
1	E	11	CYS	2.2
1	H	35	ASP	2.2
1	E	308	ARG	2.2
1	D	202	VAL	2.2
1	H	37	ALA	2.2
1	B	110	THR	2.2
1	C	301	ARG	2.2
1	G	51	ARG	2.2
1	B	118	TRP	2.1
1	H	197	ALA	2.1
1	H	128	LEU	2.1
1	B	47	GLY	2.1

Continued on next page...

Continued from previous page...

Mol	Chain	Res	Type	RSRZ
1	H	7	GLU	2.1
1	H	129	GLY	2.1
1	H	39	GLN	2.1
1	G	122	ASP	2.1
1	D	327	ALA	2.1
1	F	202	VAL	2.1
1	G	151	ASP	2.1
1	F	192	GLU	2.1
1	G	352	GLU	2.1
1	C	71	ASP	2.1
1	H	72	LEU	2.1
1	G	225	ASP	2.1
1	D	118	TRP	2.1
1	E	224	ALA	2.1
1	H	14	THR	2.1
1	F	36	ASP	2.1
1	E	205	ARG	2.1
1	D	39	GLN	2.0
1	E	7	GLU	2.0
1	F	272	ASN	2.0
1	H	88	GLN	2.0
1	C	112	THR	2.0
1	E	192	GLU	2.0

6.2 Non-standard residues in protein, DNA, RNA chains [i](#)

There are no non-standard protein/DNA/RNA residues in this entry.

6.3 Carbohydrates [i](#)

There are no monosaccharides in this entry.

6.4 Ligands [i](#)

In the following table, the Atoms column lists the number of modelled atoms in the group and the number defined in the chemical component dictionary. The B-factors column lists the minimum, median, 95th percentile and maximum values of B factors of atoms in the group. The column labelled 'Q< 0.9' lists the number of atoms with occupancy less than 0.9.

Continued on next page...

Continued from previous page...

Mol	Type	Chain	Res	Atoms	RSCC	RSR	B-factors(Å ²)	Q<0.9
3	BXO	B	355	6/6	0.93	0.21	25,26,27,28	0
3	BXO	F	355	6/6	0.93	0.17	25,26,27,28	0
3	BXO	D	355	6/6	0.94	0.21	25,26,27,28	0
2	HEM	D	354	43/43	0.95	0.16	12,13,17,17	0
3	BXO	G	355	6/6	0.95	0.20	18,20,21,21	0
3	BXO	E	355	6/6	0.96	0.17	18,20,21,21	0
2	HEM	F	354	43/43	0.96	0.15	12,13,17,17	0
2	HEM	H	354	43/43	0.96	0.15	12,13,17,17	0
3	BXO	A	355	6/6	0.97	0.20	18,20,21,21	0
2	HEM	A	354	43/43	0.97	0.14	13,15,18,18	0
3	BXO	C	355	6/6	0.97	0.17	18,20,21,21	0
2	HEM	E	354	43/43	0.97	0.15	13,15,18,18	0
2	HEM	B	354	43/43	0.97	0.14	12,13,17,17	0
2	HEM	G	354	43/43	0.97	0.13	13,15,18,18	0
2	HEM	C	354	43/43	0.97	0.13	13,15,18,18	0
3	BXO	H	355	6/6	0.97	0.16	25,26,27,28	0

The following is a graphical depiction of the model fit to experimental electron density of all instances of the Ligand of Interest. In addition, ligands with molecular weight > 250 and outliers as shown on the geometry validation Tables will also be included. Each fit is shown from different orientation to approximate a three-dimensional view.

Electron density around HEM D 354:

$2mF_o-DF_c$ (at 0.7 rmsd) in gray
 mF_o-DF_c (at 3 rmsd) in purple (negative)
and green (positive)

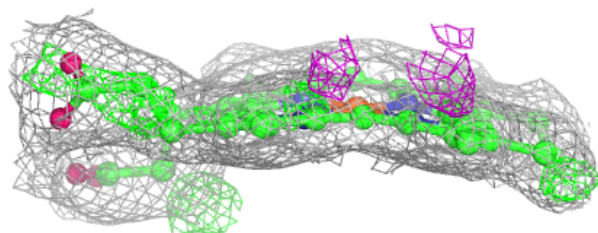
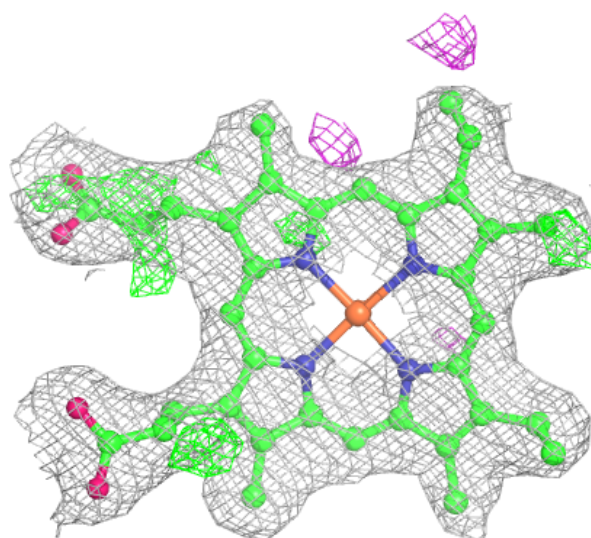

Electron density around HEM F 354:

$2mF_o-DF_c$ (at 0.7 rmsd) in gray
 mF_o-DF_c (at 3 rmsd) in purple (negative)
and green (positive)

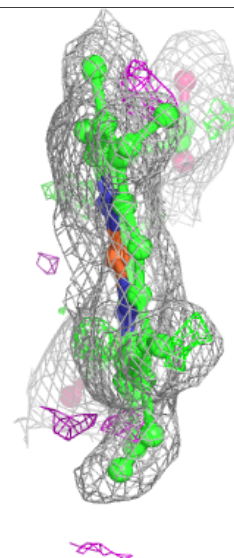
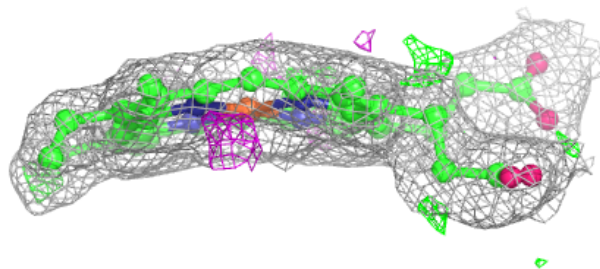
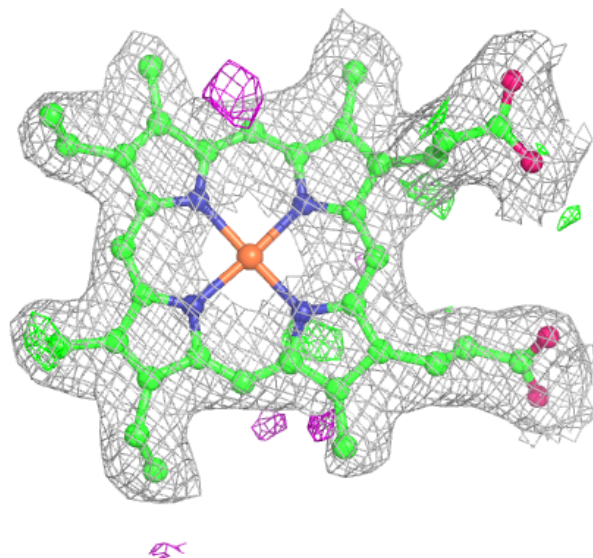

Electron density around HEM H 354:

$2mF_o-DF_c$ (at 0.7 rmsd) in gray
 mF_o-DF_c (at 3 rmsd) in purple (negative)
and green (positive)

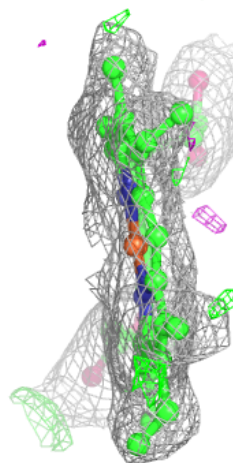
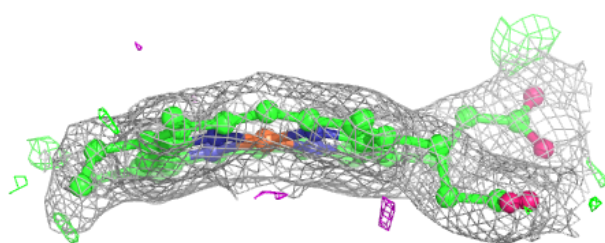
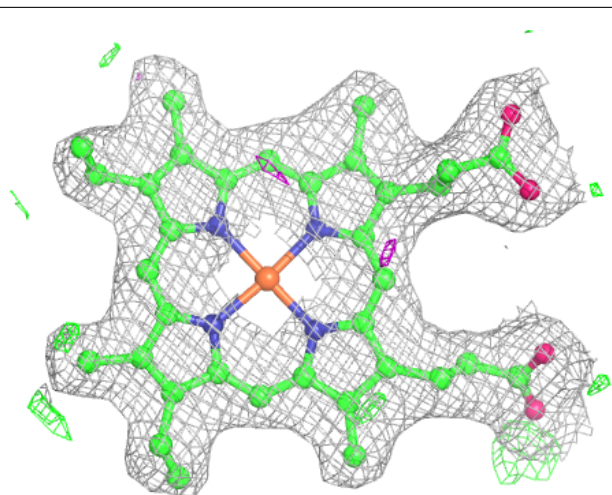

Electron density around HEM A 354:

$2mF_o-DF_c$ (at 0.7 rmsd) in gray
 mF_o-DF_c (at 3 rmsd) in purple (negative)
and green (positive)

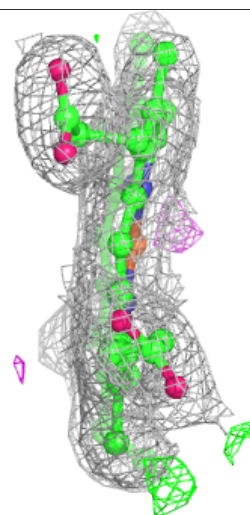
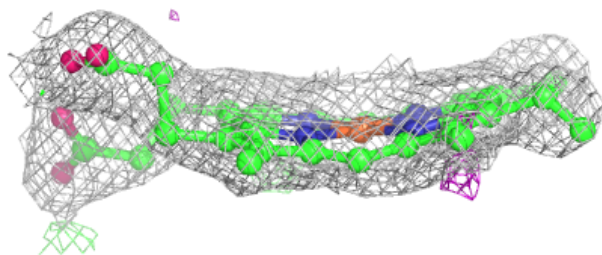
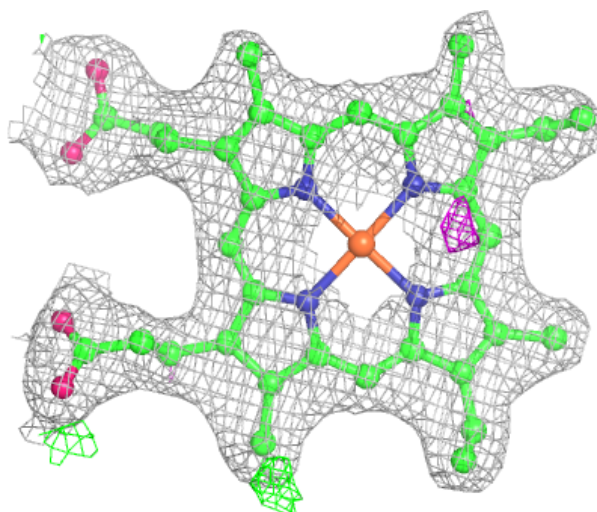

Electron density around HEM E 354:

$2mF_o-DF_c$ (at 0.7 rmsd) in gray
 mF_o-DF_c (at 3 rmsd) in purple (negative)
and green (positive)

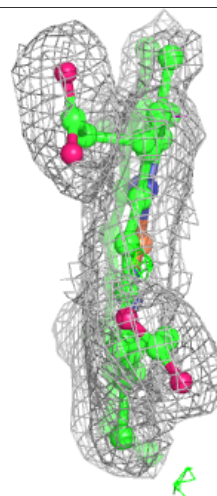
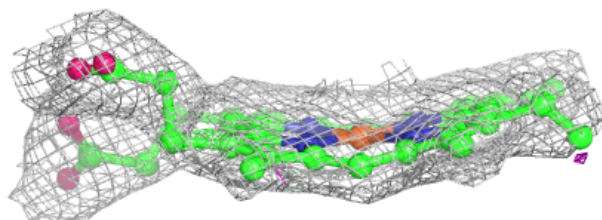
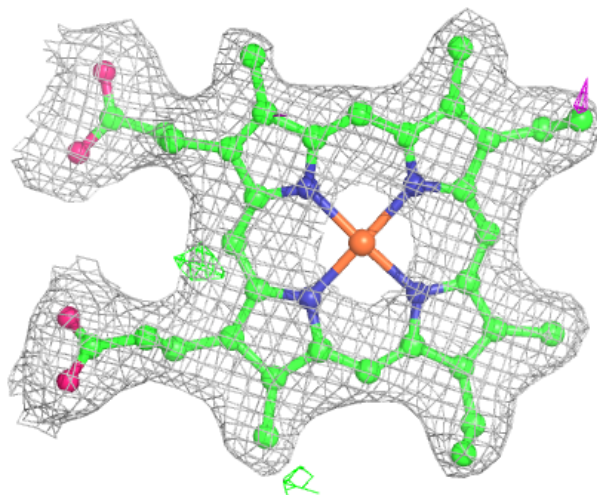

Electron density around HEM B 354:

$2mF_o-DF_c$ (at 0.7 rmsd) in gray
 mF_o-DF_c (at 3 rmsd) in purple (negative)
and green (positive)

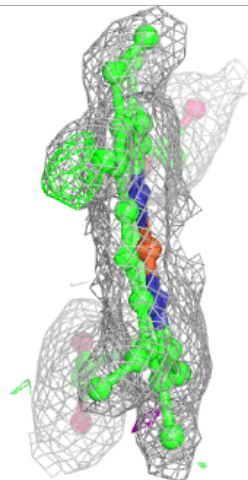
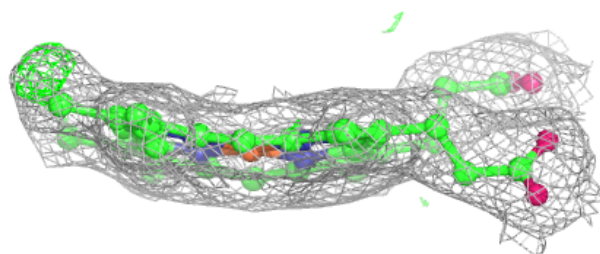
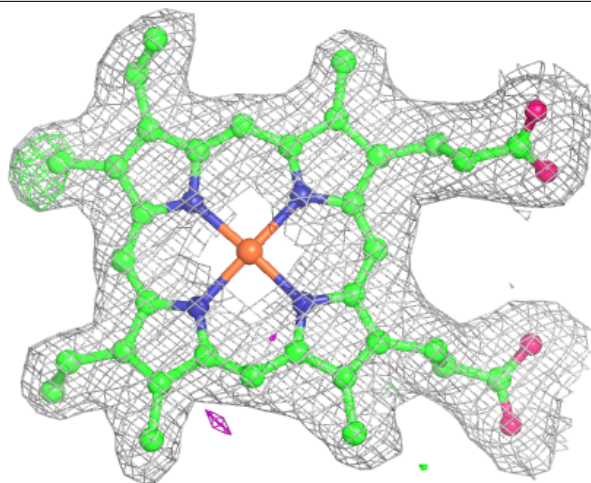

Electron density around HEM G 354:

$2mF_o-DF_c$ (at 0.7 rmsd) in gray
 mF_o-DF_c (at 3 rmsd) in purple (negative)
and green (positive)

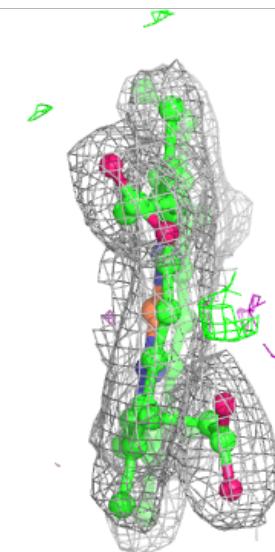
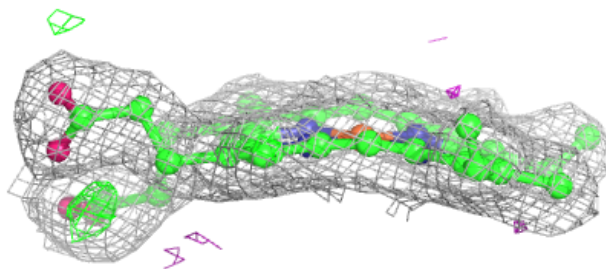
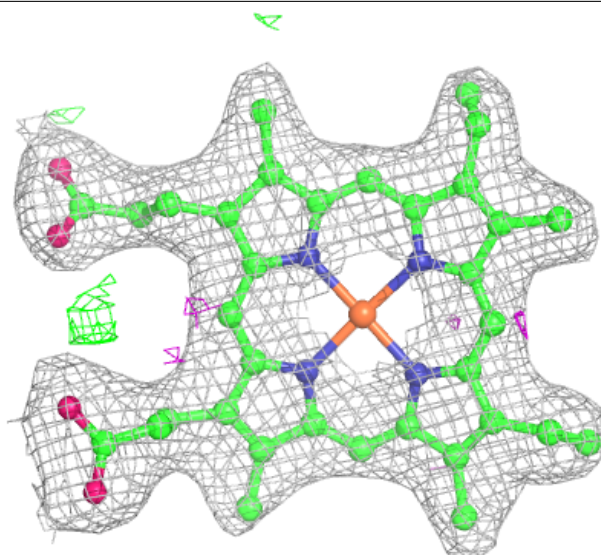

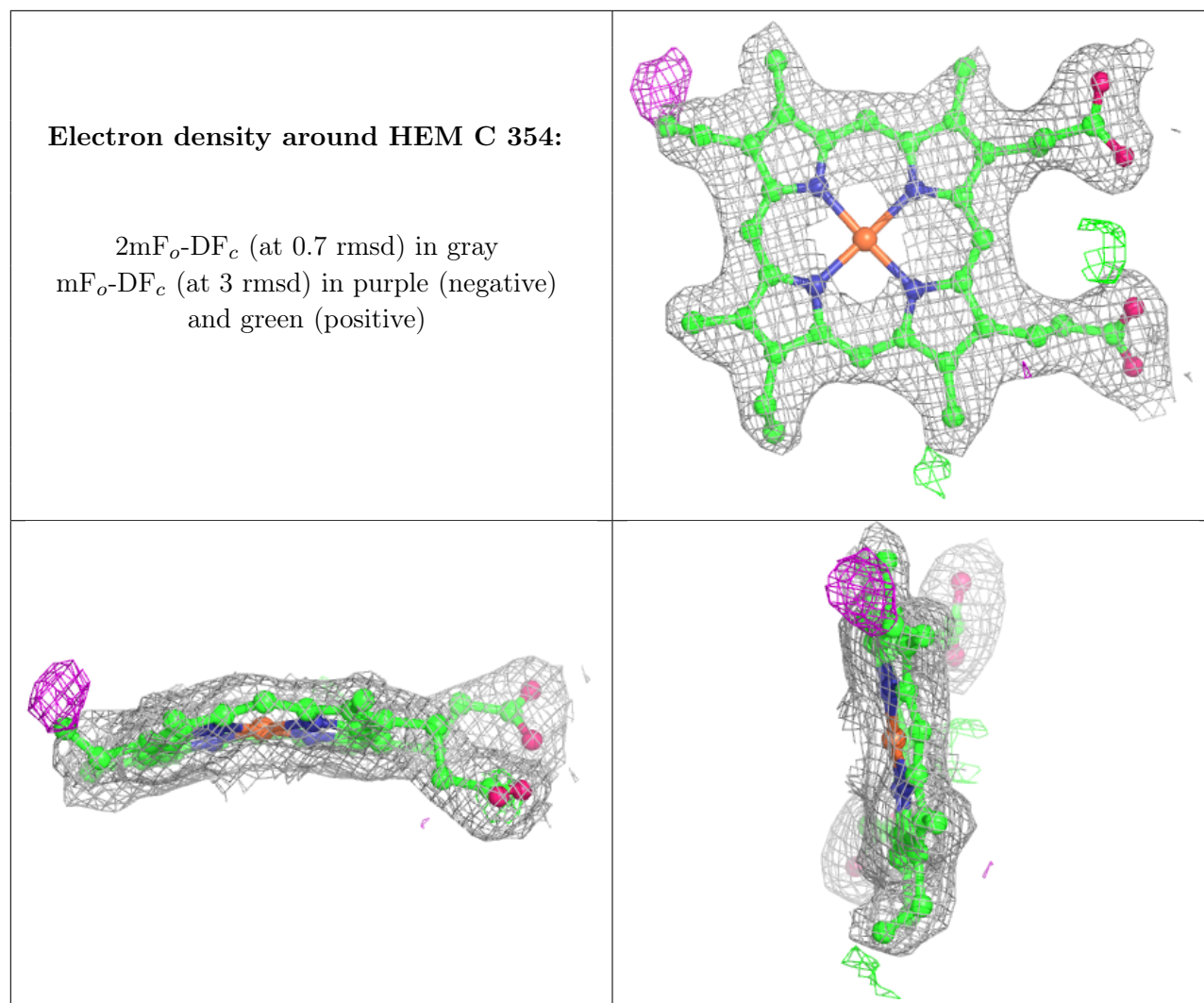

6.5 Other polymers [i](#)

There are no such residues in this entry.