



Full wwPDB X-ray Structure Validation Report ⓘ

Dec 12, 2023 – 07:32 pm GMT

PDB ID : 2XW0
Title : Human serum albumin complexed with dansyl-L-phenylalanine
Authors : Ryan, A.J.; Curry, S.
Deposited on : 2010-10-28
Resolution : 2.40 Å(reported)

This is a Full wwPDB X-ray Structure Validation Report for a publicly released PDB entry.

We welcome your comments at validation@mail.wwpdb.org

A user guide is available at

<https://www.wwpdb.org/validation/2017/XrayValidationReportHelp>

with specific help available everywhere you see the ⓘ symbol.

The types of validation reports are described at

<http://www.wwpdb.org/validation/2017/FAQs#types>.

The following versions of software and data (see [references ⓘ](#)) were used in the production of this report:

MolProbity : 4.02b-467
Mogul : 1.8.4, CSD as541be (2020)
Xtriage (Phenix) : 1.13
EDS : 2.36
buster-report : 1.1.7 (2018)
Percentile statistics : 20191225.v01 (using entries in the PDB archive December 25th 2019)
Refmac : 5.8.0158
CCP4 : 7.0.044 (Gargrove)
Ideal geometry (proteins) : Engh & Huber (2001)
Ideal geometry (DNA, RNA) : Parkinson et al. (1996)
Validation Pipeline (wwPDB-VP) : 2.36

1 Overall quality at a glance

The following experimental techniques were used to determine the structure:

X-RAY DIFFRACTION

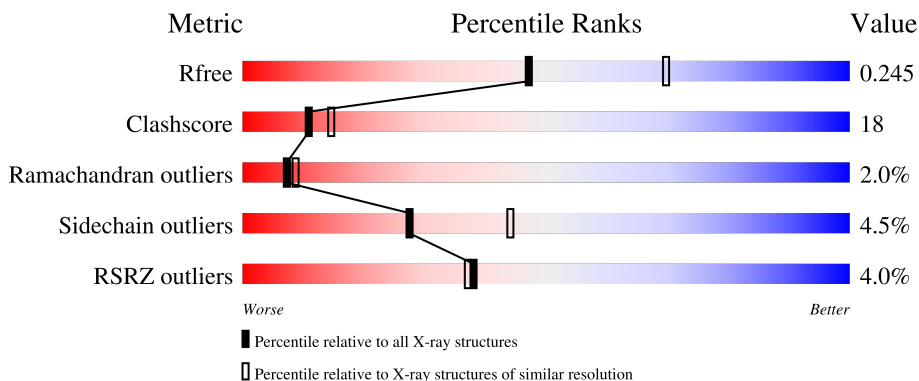

The reported resolution of this entry is 2.40 Å.

Percentile scores (ranging between 0-100) for global validation metrics of the entry are shown in the following graphic. The table shows the number of entries on which the scores are based.

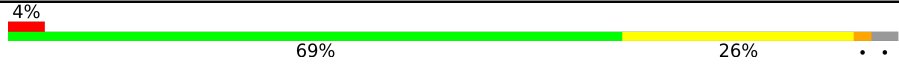

Metric	Whole archive (#Entries)	Similar resolution (#Entries, resolution range(Å))
R_{free}	130704	3907 (2.40-2.40)
Clashscore	141614	4398 (2.40-2.40)
Ramachandran outliers	138981	4318 (2.40-2.40)
Sidechain outliers	138945	4319 (2.40-2.40)
RSRZ outliers	127900	3811 (2.40-2.40)

The table below summarises the geometric issues observed across the polymeric chains and their fit to the electron density. The red, orange, yellow and green segments of the lower bar indicate the fraction of residues that contain outliers for ≥ 3 , 2, 1 and 0 types of geometric quality criteria respectively. A grey segment represents the fraction of residues that are not modelled. The numeric value for each fraction is indicated below the corresponding segment, with a dot representing fractions $\leq 5\%$. The upper red bar (where present) indicates the fraction of residues that have poor fit to the electron density. The numeric value is given above the bar.

Mol	Chain	Length	Quality of chain
1	A	585	
1	B	585	

The following table lists non-polymeric compounds, carbohydrate monomers and non-standard residues in protein, DNA, RNA chains that are outliers for geometric or electron-density-fit criteria:

Mol	Type	Chain	Res	Chirality	Geometry	Clashes	Electron density
2	9NF	A	2002	-	-	X	-
2	9NF	B	2002	-	-	X	-

2 Entry composition [i](#)

There are 3 unique types of molecules in this entry. The entry contains 8451 atoms, of which 0 are hydrogens and 0 are deuteriums.

In the tables below, the ZeroOcc column contains the number of atoms modelled with zero occupancy, the AltConf column contains the number of residues with at least one atom in alternate conformation and the Trace column contains the number of residues modelled with at most 2 atoms.

- Molecule 1 is a protein called SERUM ALBUMIN.

Mol	Chain	Residues	Atoms					ZeroOcc	AltConf	Trace
			Total	C	N	O	S			
1	A	569	Total	C	N	O	S	0	0	0
			4215	2659	706	810	40			
1	B	566	Total	C	N	O	S	0	0	0
			4114	2599	684	792	39			

- Molecule 2 is DANSYL-L-PHENYLALANINE (three-letter code: 9NF) (formula: C₂₁H₂₂N₂O₄S).

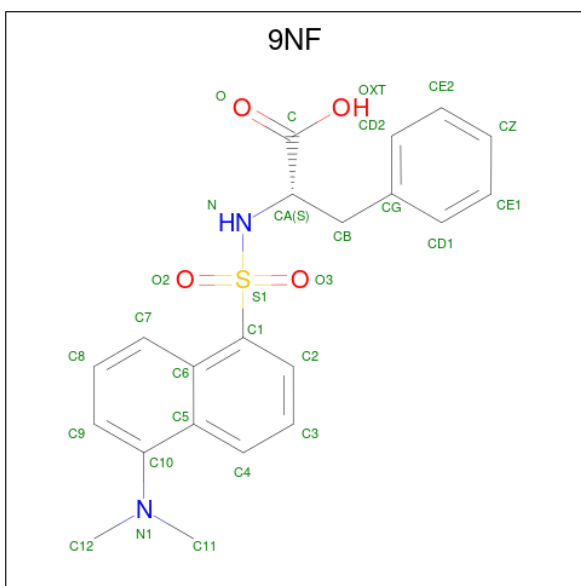

Mol	Chain	Residues	Atoms					ZeroOcc	AltConf
			Total	C	N	O	S		
2	A	1	Total	C	N	O	S	0	0
			26	21	2	2	1		
2	A	1	Total	C	N	O	S	0	0
			26	21	2	2	1		
2	B	1	Total	C	N	O	S	0	0
			26	21	2	2	1		
2	B	1	Total	C	N	O	S	0	0
			26	21	2	2	1		

- Molecule 3 is water.

Mol	Chain	Residues	Atoms	ZeroOcc	AltConf
3	A	12	Total O 12 12	0	0
3	B	6	Total O 6 6	0	0

3 Residue-property plots i

These plots are drawn for all protein, RNA, DNA and oligosaccharide chains in the entry. The first graphic for a chain summarises the proportions of the various outlier classes displayed in the second graphic. The second graphic shows the sequence view annotated by issues in geometry and electron density. Residues are color-coded according to the number of geometric quality criteria for which they contain at least one outlier: green = 0, yellow = 1, orange = 2 and red = 3 or more. A red dot above a residue indicates a poor fit to the electron density ($RSRZ > 2$). Stretches of 2 or more consecutive residues without any outlier are shown as a green connector. Residues present in the sample, but not in the model, are shown in grey.

• Molecule 1: SERUM ALBUMIN

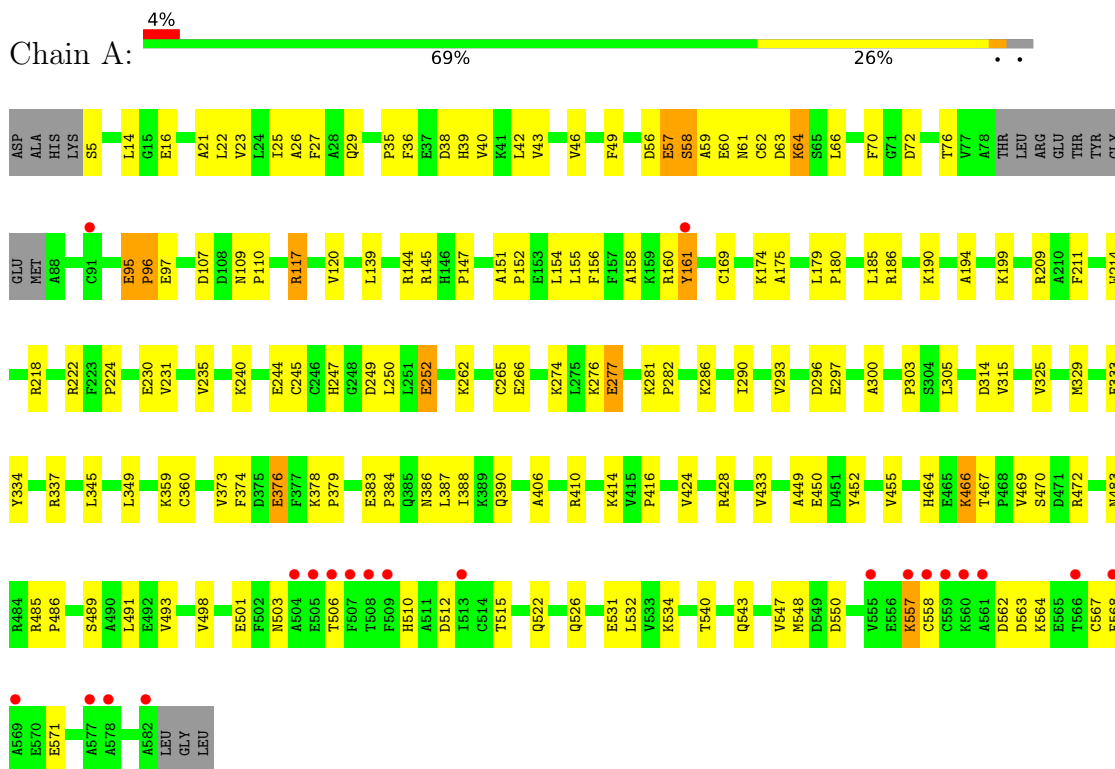

• Molecule 1: SERUM ALBUMIN

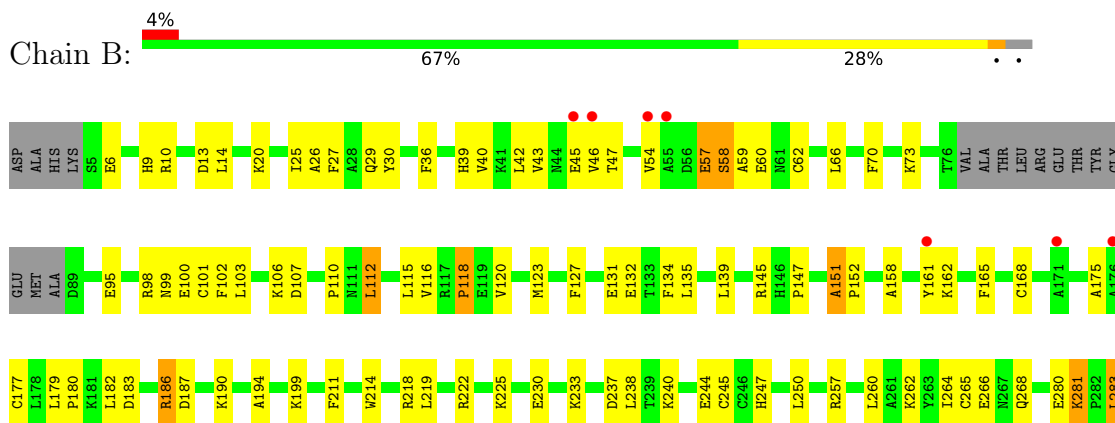

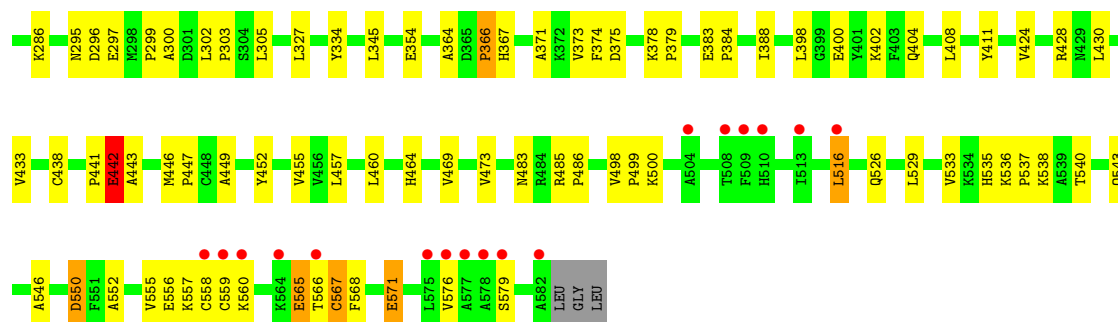

4 Data and refinement statistics

Property	Value	Source
Space group	P 1	Depositor
Cell constants a, b, c, α , β , γ	55.17Å 55.43Å 119.94Å 81.12° 91.04° 64.78°	Depositor
Resolution (Å)	28.91 – 2.40 49.33 – 2.35	Depositor EDS
% Data completeness (in resolution range)	89.4 (28.91-2.40) 88.7 (49.33-2.35)	Depositor EDS
R_{merge}	0.08	Depositor
R_{sym}	(Not available)	Depositor
$\langle I/\sigma(I) \rangle$ ¹	1.74 (at 2.34Å)	Xtrriage
Refinement program	CNS 1.2	Depositor
R, R_{free}	0.225 , 0.254 0.220 , 0.245	Depositor DCC
R_{free} test set	2504 reflections (4.77%)	wwPDB-VP
Wilson B-factor (Å ²)	54.0	Xtrriage
Anisotropy	0.232	Xtrriage
Bulk solvent k_{sol} (e/Å ³), B_{sol} (Å ²)	0.27 , 53.5	EDS
L-test for twinning ²	$\langle L \rangle = 0.49$, $\langle L^2 \rangle = 0.32$	Xtrriage
Estimated twinning fraction	No twinning to report.	Xtrriage
F_o, F_c correlation	0.95	EDS
Total number of atoms	8451	wwPDB-VP
Average B, all atoms (Å ²)	69.0	wwPDB-VP

Xtrriage's analysis on translational NCS is as follows: *The largest off-origin peak in the Patterson function is 6.22% of the height of the origin peak. No significant pseudotranslation is detected.*

¹Intensities estimated from amplitudes.

²Theoretical values of $\langle |L| \rangle$, $\langle L^2 \rangle$ for acentric reflections are 0.5, 0.333 respectively for untwinned datasets, and 0.375, 0.2 for perfectly twinned datasets.

5 Model quality [i](#)

5.1 Standard geometry [i](#)

Bond lengths and bond angles in the following residue types are not validated in this section: 9NF

The Z score for a bond length (or angle) is the number of standard deviations the observed value is removed from the expected value. A bond length (or angle) with $|Z| > 5$ is considered an outlier worth inspection. RMSZ is the root-mean-square of all Z scores of the bond lengths (or angles).

Mol	Chain	Bond lengths		Bond angles	
		RMSZ	# Z >5	RMSZ	# Z >5
1	A	0.41	0/4296	0.58	0/5848
1	B	0.39	0/4189	0.59	0/5715
All	All	0.40	0/8485	0.59	0/11563

Chiral center outliers are detected by calculating the chiral volume of a chiral center and verifying if the center is modelled as a planar moiety or with the opposite hand. A planarity outlier is detected by checking planarity of atoms in a peptide group, atoms in a mainchain group or atoms of a sidechain that are expected to be planar.

Mol	Chain	#Chirality outliers	#Planarity outliers
1	B	0	1

There are no bond length outliers.

There are no bond angle outliers.

There are no chirality outliers.

All (1) planarity outliers are listed below:

Mol	Chain	Res	Type	Group
1	B	411	TYR	Sidechain

5.2 Too-close contacts [i](#)

In the following table, the Non-H and H(model) columns list the number of non-hydrogen atoms and hydrogen atoms in the chain respectively. The H(added) column lists the number of hydrogen atoms added and optimized by MolProbity. The Clashes column lists the number of clashes within the asymmetric unit, whereas Symm-Clashes lists symmetry-related clashes.

Mol	Chain	Non-H	H(model)	H(added)	Clashes	Symm-Clashes
1	A	4215	0	3827	141	0
1	B	4114	0	3673	150	0
2	A	52	0	42	17	0
2	B	52	0	42	14	0
3	A	12	0	0	1	0
3	B	6	0	0	0	0
All	All	8451	0	7584	291	0

The all-atom clashscore is defined as the number of clashes found per 1000 atoms (including hydrogen atoms). The all-atom clashscore for this structure is 18.

All (291) close contacts within the same asymmetric unit are listed below, sorted by their clash magnitude.

Atom-1	Atom-2	Interatomic distance (Å)	Clash overlap (Å)
1:A:199:LYS:CG	2:A:2002:9NF:H113	1.58	1.30
1:A:199:LYS:HG2	2:A:2002:9NF:C11	1.75	1.17
1:B:536:LYS:CD	1:B:536:LYS:CB	2.45	0.95
1:A:199:LYS:HA	2:A:2002:9NF:H111	1.49	0.95
1:B:42:LEU:O	1:B:46:VAL:HG23	1.71	0.89
1:A:557:LYS:HE2	1:A:558:CYS:HB2	1.56	0.88
1:A:274:LYS:HE3	1:A:296:ASP:HA	1.56	0.88
1:A:383:GLU:HB3	1:A:384:PRO:HD3	1.56	0.87
1:B:571:GLU:H	1:B:571:GLU:CD	1.77	0.87
1:B:345:LEU:HD22	1:B:446:MET:HE1	1.58	0.86
1:A:557:LYS:HD3	1:A:558:CYS:H	1.40	0.85
1:B:567:CYS:SG	1:B:571:GLU:OE2	2.35	0.84
1:B:433:VAL:HG22	1:B:452:TYR:HD2	1.41	0.84
1:B:500:LYS:O	1:B:535:HIS:HD2	1.61	0.84
1:B:151:ALA:HB3	1:B:152:PRO:HD3	1.58	0.84
1:A:66:LEU:O	1:A:70:PHE:HD1	1.61	0.84
1:A:61:ASN:HB3	1:A:64:LYS:HD2	1.59	0.82
1:A:199:LYS:CG	2:A:2002:9NF:C11	2.46	0.80
1:B:571:GLU:N	1:B:571:GLU:OE1	2.14	0.80
1:B:120:VAL:HG21	1:B:175:ALA:HA	1.63	0.78
1:B:95:GLU:OE1	1:B:99:ASN:HB2	1.84	0.78
1:A:199:LYS:HA	2:A:2002:9NF:C11	2.14	0.77
1:A:35:PRO:HG2	1:A:38:ASP:OD2	1.85	0.76
1:A:557:LYS:CD	1:A:558:CYS:H	1.99	0.76
1:B:424:VAL:O	1:B:428:ARG:HG3	1.85	0.76
1:B:66:LEU:O	1:B:70:PHE:HD1	1.68	0.76
1:B:433:VAL:HG22	1:B:452:TYR:CD2	2.21	0.75
1:A:199:LYS:HG2	2:A:2002:9NF:H113	0.80	0.75

Continued on next page...

Continued from previous page...

Atom-1	Atom-2	Interatomic distance (Å)	Clash overlap (Å)
1:B:46:VAL:HG22	1:B:73:LYS:CD	2.17	0.75
1:B:199:LYS:HA	2:B:2002:9NF:H111	1.69	0.74
1:A:540:THR:H	1:A:543:GLN:NE2	1.86	0.74
1:B:442:GLU:CD	1:B:442:GLU:H	1.91	0.74
1:B:39:HIS:O	1:B:43:VAL:HG23	1.87	0.73
1:B:516:LEU:HD12	1:B:516:LEU:H	1.53	0.73
1:A:557:LYS:CE	1:A:558:CYS:HB2	2.18	0.73
1:B:240:LYS:O	1:B:244:GLU:HG3	1.89	0.72
1:A:156:PHE:CZ	1:A:160:ARG:HD3	2.24	0.72
1:B:400:GLU:O	1:B:404:GLN:HG3	1.90	0.71
1:B:378:LYS:HB2	1:B:379:PRO:HD3	1.72	0.71
1:B:199:LYS:HA	2:B:2002:9NF:C11	2.21	0.71
1:B:110:PRO:HB2	1:B:112:LEU:CD2	2.21	0.70
1:B:152:PRO:HB2	1:B:257:ARG:HH11	1.55	0.70
1:A:161:TYR:CD1	1:A:185:LEU:HD13	2.27	0.70
1:A:214:TRP:CD2	2:A:2002:9NF:H122	2.26	0.69
1:A:424:VAL:O	1:A:428:ARG:HG3	1.93	0.69
1:B:183:ASP:OD1	1:B:186:ARG:NH2	2.26	0.69
1:A:557:LYS:HE3	1:A:571:GLU:CB	2.22	0.69
1:B:483:ASN:O	1:B:486:PRO:HD2	1.93	0.68
1:B:483:ASN:C	1:B:486:PRO:HD2	2.14	0.68
1:A:117:ARG:CD	1:A:117:ARG:H	2.07	0.68
1:A:386:ASN:O	1:A:390:GLN:HG3	1.93	0.68
1:A:218:ARG:NH2	1:A:222:ARG:HH21	1.92	0.67
1:B:199:LYS:HG2	2:B:2002:9NF:H113	1.76	0.66
1:B:265:CYS:O	1:B:268:GLN:HG3	1.96	0.66
1:B:186:ARG:O	1:B:190:LYS:HG3	1.95	0.66
1:B:567:CYS:HA	1:B:571:GLU:OE2	1.96	0.65
1:A:151:ALA:HB3	1:A:152:PRO:HD3	1.78	0.65
1:B:110:PRO:HB2	1:B:112:LEU:HD22	1.79	0.65
1:A:120:VAL:HG11	1:A:174:LYS:HB2	1.80	0.63
1:A:540:THR:H	1:A:543:GLN:HE21	1.47	0.63
1:A:199:LYS:CA	2:A:2002:9NF:C11	2.77	0.63
1:A:240:LYS:O	1:A:244:GLU:HG3	1.99	0.62
1:A:169:CYS:HA	1:A:174:LYS:HD3	1.82	0.62
1:A:222:ARG:NH1	2:A:2002:9NF:HD2	2.14	0.62
1:B:25:ILE:O	1:B:29:GLN:HG3	2.00	0.62
1:A:510:HIS:HA	1:A:568:PHE:CB	2.30	0.61
1:B:345:LEU:HD22	1:B:446:MET:CE	2.30	0.61
1:B:283:LEU:O	1:B:286:LYS:HB3	2.01	0.61
1:B:364:ALA:O	1:B:366:PRO:HD3	2.00	0.61

Continued on next page...

Continued from previous page...

Atom-1	Atom-2	Interatomic distance (Å)	Clash overlap (Å)
1:B:106:LYS:HD3	1:B:147:PRO:HB2	1.84	0.60
1:B:567:CYS:CA	1:B:571:GLU:OE2	2.49	0.60
1:A:36:PHE:O	1:A:40:VAL:HG23	2.02	0.60
1:A:274:LYS:CE	1:A:296:ASP:HA	2.32	0.60
1:B:66:LEU:O	1:B:70:PHE:CD1	2.54	0.60
1:A:378:LYS:HB3	1:A:379:PRO:HD3	1.84	0.59
1:B:540:THR:HG23	1:B:543:GLN:H	1.67	0.59
1:B:59:ALA:HB3	1:B:62:CYS:SG	2.42	0.59
1:B:373:VAL:HG13	1:B:374:PHE:HD1	1.68	0.59
1:B:127:PHE:O	1:B:131:GLU:HB3	2.02	0.59
1:B:398:LEU:HB3	1:B:402:LYS:HB2	1.84	0.59
1:B:557:LYS:HG3	1:B:558:CYS:N	2.17	0.58
1:A:156:PHE:CE2	1:A:160:ARG:HD3	2.38	0.58
1:A:29:GLN:HG2	1:A:147:PRO:HA	1.84	0.58
1:B:384:PRO:O	1:B:388:ILE:HG12	2.03	0.58
1:A:117:ARG:H	1:A:117:ARG:HD2	1.69	0.58
1:A:557:LYS:HE2	1:A:558:CYS:CB	2.31	0.58
1:A:218:ARG:CZ	1:A:222:ARG:HH21	2.16	0.57
1:A:557:LYS:CG	1:A:558:CYS:N	2.67	0.57
1:B:107:ASP:OD2	1:B:110:PRO:N	2.37	0.57
1:B:222:ARG:HA	1:B:295:ASN:OD1	2.04	0.57
1:B:116:VAL:O	1:B:118:PRO:HD3	2.04	0.57
1:B:438:CYS:SG	2:B:2001:9NF:H121	2.44	0.57
1:B:558:CYS:SG	1:B:571:GLU:OE2	2.63	0.57
1:A:5:SER:HA	1:A:62:CYS:O	2.04	0.57
1:A:483:ASN:C	1:A:486:PRO:HD2	2.25	0.57
1:A:199:LYS:CB	2:A:2002:9NF:H113	2.33	0.57
1:A:557:LYS:CD	1:A:558:CYS:N	2.67	0.57
1:B:214:TRP:CG	2:B:2002:9NF:H122	2.39	0.57
1:B:135:LEU:HD11	1:B:162:LYS:CG	2.35	0.57
1:B:211:PHE:CZ	2:B:2002:9NF:H3	2.40	0.56
1:A:224:PRO:HD2	1:A:296:ASP:HB3	1.87	0.56
1:B:552:ALA:O	1:B:555:VAL:HG12	2.06	0.56
1:A:222:ARG:HH12	2:A:2002:9NF:HD2	1.70	0.56
1:B:98:ARG:O	1:B:101:CYS:HB3	2.05	0.56
1:A:222:ARG:O	1:A:224:PRO:HD3	2.07	0.55
1:A:498:VAL:HG23	1:A:498:VAL:O	2.05	0.55
1:B:247:HIS:O	1:B:247:HIS:ND1	2.39	0.55
1:A:222:ARG:C	1:A:224:PRO:HD3	2.28	0.55
1:A:384:PRO:O	1:A:388:ILE:HG12	2.07	0.55
1:A:107:ASP:O	1:A:110:PRO:HD3	2.06	0.54

Continued on next page...

Continued from previous page...

Atom-1	Atom-2	Interatomic distance (Å)	Clash overlap (Å)
1:B:460:LEU:O	1:B:460:LEU:HD12	2.06	0.54
1:A:120:VAL:HG21	1:A:175:ALA:HA	1.90	0.54
1:B:262:LYS:O	1:B:266:GLU:HG3	2.07	0.54
1:B:499:PRO:HB3	1:B:535:HIS:O	2.07	0.54
1:A:61:ASN:HB3	1:A:64:LYS:CD	2.37	0.54
1:A:186:ARG:O	1:A:190:LYS:HG3	2.08	0.53
1:A:414:LYS:O	1:A:472:ARG:NH1	2.42	0.53
1:B:516:LEU:HD12	1:B:516:LEU:N	2.23	0.53
1:B:430:LEU:O	1:B:433:VAL:HG23	2.09	0.53
1:B:218:ARG:NH2	1:B:222:ARG:HH21	2.07	0.53
1:A:27:PHE:CE1	1:A:70:PHE:HD2	2.27	0.53
1:A:139:LEU:HD21	1:A:158:ALA:HB2	1.91	0.53
1:B:186:ARG:HG2	1:B:187:ASP:N	2.23	0.53
1:A:209:ARG:HD2	1:A:209:ARG:O	2.08	0.52
1:B:199:LYS:CG	2:B:2002:9NF:H113	2.39	0.52
1:B:260:LEU:O	1:B:264:ILE:HG13	2.10	0.52
1:A:179:LEU:HB2	1:A:180:PRO:HD3	1.90	0.52
1:B:110:PRO:HB2	1:B:112:LEU:HD21	1.91	0.52
1:B:540:THR:CG2	1:B:543:GLN:HG2	2.40	0.52
1:A:63:ASP:OD1	1:A:64:LYS:HE3	2.09	0.52
1:A:199:LYS:CA	2:A:2002:9NF:H111	2.30	0.52
1:A:66:LEU:O	1:A:70:PHE:CD1	2.51	0.52
1:A:557:LYS:HG2	1:A:558:CYS:N	2.24	0.52
1:A:503:ASN:ND2	1:A:506:THR:OG1	2.43	0.51
1:A:512:ASP:O	1:A:515:THR:HG22	2.10	0.51
1:B:557:LYS:HG3	1:B:558:CYS:H	1.76	0.51
1:A:96:PRO:HG2	1:A:97:GLU:H	1.75	0.51
1:A:23:VAL:HG13	1:A:70:PHE:HE2	1.76	0.51
1:A:290:ILE:O	1:A:293:VAL:HG22	2.10	0.51
1:A:194:ALA:HB1	1:A:455:VAL:CG1	2.41	0.50
1:B:120:VAL:HG21	1:B:175:ALA:CA	2.36	0.50
1:A:388:ILE:HD12	1:A:449:ALA:CB	2.41	0.50
1:A:383:GLU:HB3	1:A:384:PRO:CD	2.37	0.50
1:B:558:CYS:SG	1:B:571:GLU:HG3	2.51	0.50
1:B:168:CYS:SG	1:B:177:CYS:C	2.90	0.49
1:B:485:ARG:HD2	1:B:485:ARG:O	2.12	0.49
1:A:160:ARG:HH21	1:A:185:LEU:CD2	2.25	0.49
1:B:107:ASP:OD2	1:B:110:PRO:CA	2.60	0.49
1:A:5:SER:HB3	1:A:57:GLU:HG3	1.95	0.49
1:A:281:LYS:HB2	1:A:282:PRO:CD	2.43	0.49
1:B:152:PRO:HB2	1:B:257:ARG:NH1	2.26	0.49

Continued on next page...

Continued from previous page...

Atom-1	Atom-2	Interatomic distance (Å)	Clash overlap (Å)
1:A:72:ASP:O	1:A:76:THR:HG23	2.12	0.49
1:A:325:VAL:O	1:A:329:MET:HG3	2.13	0.48
1:A:345:LEU:O	1:A:349:LEU:HG	2.13	0.48
1:B:57:GLU:O	1:B:58:SER:C	2.51	0.48
1:B:540:THR:HG22	1:B:543:GLN:OE1	2.13	0.48
1:A:281:LYS:HB2	1:A:282:PRO:HD2	1.95	0.48
1:A:414:LYS:HE2	1:A:491:LEU:O	2.12	0.48
1:B:442:GLU:CD	1:B:442:GLU:N	2.64	0.48
1:B:558:CYS:C	1:B:560:LYS:H	2.16	0.48
1:B:558:CYS:O	1:B:560:LYS:N	2.46	0.48
1:B:151:ALA:CB	1:B:152:PRO:HD3	2.39	0.48
1:A:26:ALA:HB2	1:A:250:LEU:HD12	1.94	0.48
1:B:9:HIS:CD2	1:B:13:ASP:OD2	2.66	0.48
1:B:151:ALA:HB3	1:B:152:PRO:CD	2.39	0.48
1:B:529:LEU:O	1:B:533:VAL:HG23	2.14	0.48
1:B:498:VAL:O	1:B:498:VAL:HG23	2.14	0.48
1:A:145:ARG:HG3	1:A:145:ARG:HH11	1.79	0.48
1:B:20:LYS:HE2	1:B:47:THR:HG21	1.95	0.47
1:B:179:LEU:CB	1:B:180:PRO:HD3	2.44	0.47
1:B:225:LYS:HG2	1:B:299:PRO:HG3	1.96	0.47
1:B:558:CYS:C	1:B:560:LYS:N	2.66	0.47
1:A:95:GLU:CB	1:A:96:PRO:CD	2.91	0.47
1:A:286:LYS:O	1:A:290:ILE:HG13	2.13	0.47
1:A:540:THR:N	1:A:543:GLN:NE2	2.59	0.47
1:B:187:ASP:HA	1:B:190:LYS:HE3	1.96	0.47
1:A:61:ASN:HD22	1:A:64:LYS:NZ	2.13	0.47
1:A:39:HIS:O	1:A:43:VAL:HG23	2.15	0.47
1:A:156:PHE:O	1:A:160:ARG:HG3	2.14	0.47
1:A:557:LYS:CE	1:A:571:GLU:CB	2.92	0.47
1:B:557:LYS:CG	1:B:558:CYS:N	2.78	0.47
1:A:117:ARG:H	1:A:117:ARG:HD3	1.79	0.47
1:A:506:THR:CG2	1:A:531:GLU:HG3	2.45	0.47
1:B:367:HIS:O	1:B:371:ALA:HB2	2.15	0.47
1:A:464:HIS:HE1	1:A:470:SER:H	1.61	0.46
1:B:238:LEU:CD2	2:B:2002:9NF:H2	2.46	0.46
1:B:139:LEU:HD21	1:B:158:ALA:HB2	1.96	0.46
1:B:442:GLU:N	1:B:442:GLU:OE1	2.36	0.46
1:A:27:PHE:HE1	1:A:70:PHE:HD2	1.62	0.46
1:A:406:ALA:O	1:A:410:ARG:HG2	2.15	0.46
1:A:564:LYS:HB3	1:A:567:CYS:SG	2.55	0.46
1:B:36:PHE:O	1:B:40:VAL:HG23	2.16	0.46

Continued on next page...

Continued from previous page...

Atom-1	Atom-2	Interatomic distance (Å)	Clash overlap (Å)
1:B:230:GLU:O	1:B:233:LYS:HB3	2.16	0.46
1:A:262:LYS:O	1:A:266:GLU:HG3	2.15	0.46
1:B:388:ILE:HA	2:B:2001:9NF:H9	1.98	0.45
1:B:557:LYS:CD	1:B:571:GLU:HB2	2.45	0.45
1:B:30:TYR:HE1	1:B:103:LEU:HD23	1.81	0.45
1:A:359:LYS:CG	1:A:360:CYS:N	2.80	0.45
1:A:416:PRO:O	1:A:534:LYS:HE2	2.17	0.45
1:B:20:LYS:CE	1:B:47:THR:HG21	2.46	0.45
1:B:565:GLU:O	1:B:566:THR:C	2.53	0.45
1:A:199:LYS:HE2	2:A:2002:9NF:C	2.46	0.45
1:B:161:TYR:CZ	1:B:165:PHE:HE1	2.34	0.45
1:B:464:HIS:CE1	1:B:469:VAL:H	2.33	0.45
1:A:247:HIS:O	1:A:247:HIS:ND1	2.49	0.45
1:B:26:ALA:HB2	1:B:250:LEU:HD12	1.99	0.45
1:A:540:THR:OG1	1:A:543:GLN:HG3	2.16	0.45
1:A:211:PHE:CZ	2:A:2002:9NF:H3	2.51	0.45
1:A:433:VAL:HG12	2:A:2001:9NF:H113	1.99	0.45
1:A:483:ASN:O	1:A:486:PRO:HD2	2.16	0.45
1:A:387:LEU:HD22	1:A:485:ARG:NH1	2.31	0.45
1:A:305:LEU:HD13	1:A:334:TYR:CD2	2.53	0.44
1:A:265:CYS:SG	1:A:286:LYS:HD2	2.57	0.44
1:A:540:THR:N	1:A:543:GLN:HE21	2.12	0.44
1:B:556:GLU:O	1:B:556:GLU:HG2	2.17	0.44
1:A:42:LEU:O	1:A:46:VAL:HG23	2.17	0.44
1:A:296:ASP:OD1	1:A:297:GLU:N	2.50	0.44
1:A:563:ASP:O	1:A:564:LYS:HD3	2.18	0.44
1:B:222:ARG:HH11	2:B:2002:9NF:HE1	1.83	0.44
1:B:540:THR:HG23	1:B:543:GLN:HG2	1.99	0.44
1:A:35:PRO:CG	1:A:38:ASP:OD2	2.62	0.44
1:A:373:VAL:HG13	1:A:374:PHE:HD1	1.83	0.44
1:B:9:HIS:HD2	1:B:13:ASP:OD2	2.01	0.44
1:A:61:ASN:HD22	1:A:64:LYS:HZ3	1.65	0.44
1:A:464:HIS:CE1	1:A:470:SER:H	2.36	0.44
1:A:522:GLN:O	1:A:526:GLN:HG3	2.18	0.44
1:B:500:LYS:O	1:B:535:HIS:CD2	2.53	0.44
1:B:557:LYS:CG	1:B:558:CYS:H	2.31	0.44
1:A:56:ASP:C	1:A:58:SER:H	2.21	0.43
1:A:277:GLU:H	1:A:277:GLU:HG2	1.42	0.43
1:A:303:PRO:O	1:A:337:ARG:NH1	2.50	0.43
1:B:219:LEU:HD21	2:B:2002:9NF:O3	2.17	0.43
1:A:388:ILE:HD13	2:A:2001:9NF:H9	2.00	0.43

Continued on next page...

Continued from previous page...

Atom-1	Atom-2	Interatomic distance (Å)	Clash overlap (Å)
1:B:123:MET:HE1	1:B:182:LEU:HD21	2.00	0.43
1:A:231:VAL:O	1:A:235:VAL:HG23	2.18	0.43
1:A:21:ALA:HB1	1:A:155:LEU:HD21	2.00	0.43
1:A:21:ALA:CB	1:A:155:LEU:HD21	2.48	0.43
1:B:305:LEU:HD13	1:B:334:TYR:CD2	2.54	0.43
1:B:543:GLN:O	1:B:546:ALA:HB3	2.18	0.43
1:B:237:ASP:CB	1:B:260:LEU:HD12	2.49	0.43
1:B:388:ILE:HD12	1:B:449:ALA:CB	2.49	0.43
1:A:276:LYS:HG3	3:A:2003:HOH:O	2.19	0.43
1:A:160:ARG:HH21	1:A:185:LEU:HD23	1.84	0.42
1:B:280:GLU:OE1	1:B:280:GLU:HA	2.18	0.42
1:B:446:MET:HB3	1:B:447:PRO:HD3	2.00	0.42
1:B:99:ASN:HA	1:B:102:PHE:HD2	1.84	0.42
1:B:327:LEU:HD11	1:B:354:GLU:HG3	2.00	0.42
1:B:441:PRO:O	1:B:443:ALA:N	2.52	0.42
1:A:66:LEU:HD12	1:A:252:GLU:OE2	2.19	0.42
1:B:408:LEU:HD11	1:B:526:GLN:HB3	2.02	0.42
1:A:25:ILE:HD13	1:A:154:LEU:HD23	2.02	0.42
1:A:117:ARG:CD	1:A:117:ARG:N	2.76	0.42
1:A:218:ARG:CG	2:A:2002:9NF:O2	2.68	0.42
1:B:566:THR:O	1:B:567:CYS:C	2.58	0.42
1:A:249:ASP:HB3	1:A:252:GLU:CG	2.50	0.42
1:A:464:HIS:CE1	1:A:469:VAL:H	2.37	0.42
1:B:383:GLU:HB3	1:B:384:PRO:CD	2.50	0.42
1:A:485:ARG:HB3	1:A:486:PRO:HD3	2.02	0.41
1:A:14:LEU:HD13	1:A:22:LEU:HD12	2.02	0.41
1:B:186:ARG:HE	1:B:186:ARG:HB3	1.69	0.41
1:B:296:ASP:OD1	1:B:297:GLU:N	2.53	0.41
1:B:302:LEU:HA	1:B:303:PRO:HD3	1.90	0.41
1:B:10:ARG:O	1:B:14:LEU:HD23	2.21	0.41
1:B:161:TYR:CE2	1:B:165:PHE:CE1	3.09	0.41
1:B:281:LYS:H	1:B:281:LYS:HG2	1.65	0.41
1:B:388:ILE:HD13	2:B:2001:9NF:H9	2.02	0.41
1:A:373:VAL:O	1:A:376:GLU:HB2	2.21	0.41
1:B:115:LEU:HD21	1:B:145:ARG:CZ	2.50	0.41
1:B:457:LEU:HA	1:B:457:LEU:HD23	1.87	0.41
1:A:145:ARG:HG3	1:A:145:ARG:NH1	2.35	0.41
1:B:194:ALA:HB1	1:B:455:VAL:CG1	2.50	0.41
1:B:485:ARG:HD2	1:B:485:ARG:C	2.41	0.41
1:B:107:ASP:OD2	1:B:110:PRO:HA	2.21	0.41
1:B:546:ALA:O	1:B:550:ASP:OD1	2.38	0.41

Continued on next page...

Continued from previous page...

Atom-1	Atom-2	Interatomic distance (Å)	Clash overlap (Å)
1:B:540:THR:HG22	1:B:543:GLN:CG	2.51	0.41
1:A:305:LEU:HD21	1:A:333:GLU:HB3	2.03	0.41
1:B:127:PHE:HD1	1:B:134:PHE:CD2	2.39	0.41
1:B:567:CYS:C	1:B:571:GLU:OE2	2.60	0.41
1:B:576:VAL:HA	1:B:579:SER:HB2	2.03	0.41
1:A:498:VAL:O	1:A:498:VAL:CG2	2.67	0.41
1:B:464:HIS:CG	1:B:473:VAL:HG11	2.56	0.41
1:B:537:PRO:HG2	1:B:538:LYS:H	1.86	0.41
1:A:373:VAL:HG13	1:A:374:PHE:CD1	2.56	0.40
1:A:557:LYS:NZ	1:A:558:CYS:HB2	2.35	0.40
1:A:543:GLN:O	1:A:547:VAL:HG23	2.22	0.40
1:B:100:GLU:HG2	1:B:103:LEU:HD12	2.04	0.40
1:A:466:LYS:HE2	1:A:466:LYS:HB3	1.93	0.40
1:B:27:PHE:N	1:B:27:PHE:CD1	2.89	0.40
1:B:199:LYS:HA	2:B:2002:9NF:H113	1.98	0.40
1:B:161:TYR:CE2	1:B:165:PHE:HE1	2.39	0.40
1:B:238:LEU:HD11	2:B:2002:9NF:HB1C	2.04	0.40

There are no symmetry-related clashes.

5.3 Torsion angles [i](#)

5.3.1 Protein backbone [i](#)

In the following table, the Percentiles column shows the percent Ramachandran outliers of the chain as a percentile score with respect to all X-ray entries followed by that with respect to entries of similar resolution.

The Analysed column shows the number of residues for which the backbone conformation was analysed, and the total number of residues.

Mol	Chain	Analysed	Favoured	Allowed	Outliers	Percentiles	
1	A	565/585 (97%)	520 (92%)	36 (6%)	9 (2%)	9	13
1	B	562/585 (96%)	506 (90%)	42 (8%)	14 (2%)	5	6
All	All	1127/1170 (96%)	1026 (91%)	78 (7%)	23 (2%)	7	9

All (23) Ramachandran outliers are listed below:

Mol	Chain	Res	Type
1	A	59	ALA

Continued on next page...

Continued from previous page...

Mol	Chain	Res	Type
1	A	95	GLU
1	B	54	VAL
1	B	57	GLU
1	B	58	SER
1	B	300	ALA
1	B	565	GLU
1	A	60	GLU
1	A	300	ALA
1	B	283	LEU
1	B	442	GLU
1	B	567	CYS
1	B	568	PHE
1	A	562	ASP
1	A	57	GLU
1	A	58	SER
1	A	315	VAL
1	B	60	GLU
1	B	118	PRO
1	B	559	CYS
1	B	151	ALA
1	A	96	PRO
1	B	366	PRO

5.3.2 Protein sidechains [i](#)

In the following table, the Percentiles column shows the percent sidechain outliers of the chain as a percentile score with respect to all X-ray entries followed by that with respect to entries of similar resolution.

The Analysed column shows the number of residues for which the sidechain conformation was analysed, and the total number of residues.

Mol	Chain	Analysed	Rotameric	Outliers	Percentiles	
1	A	412/511 (81%)	388 (94%)	24 (6%)	20	32
1	B	390/511 (76%)	378 (97%)	12 (3%)	40	60
All	All	802/1022 (78%)	766 (96%)	36 (4%)	27	44

All (36) residues with a non-rotameric sidechain are listed below:

Mol	Chain	Res	Type
1	A	16	GLU

Continued on next page...

Continued from previous page...

Mol	Chain	Res	Type
1	A	49	PHE
1	A	64	LYS
1	A	109	ASN
1	A	117	ARG
1	A	144	ARG
1	A	161	TYR
1	A	230	GLU
1	A	245	CYS
1	A	252	GLU
1	A	277	GLU
1	A	314	ASP
1	A	376	GLU
1	A	450	GLU
1	A	452	TYR
1	A	466	LYS
1	A	467	THR
1	A	489	SER
1	A	493	VAL
1	A	501	GLU
1	A	532	LEU
1	A	548	MET
1	A	550	ASP
1	A	557	LYS
1	B	6	GLU
1	B	45	GLU
1	B	112	LEU
1	B	132	GLU
1	B	186	ARG
1	B	245	CYS
1	B	281	LYS
1	B	375	ASP
1	B	442	GLU
1	B	516	LEU
1	B	550	ASP
1	B	571	GLU

Sometimes sidechains can be flipped to improve hydrogen bonding and reduce clashes. All (14) such sidechains are listed below:

Mol	Chain	Res	Type
1	A	29	GLN
1	A	39	HIS
1	A	61	ASN

Continued on next page...

Continued from previous page...

Mol	Chain	Res	Type
1	A	109	ASN
1	A	318	ASN
1	A	464	HIS
1	A	483	ASN
1	A	503	ASN
1	A	543	GLN
1	B	9	HIS
1	B	318	ASN
1	B	464	HIS
1	B	483	ASN
1	B	535	HIS

5.3.3 RNA [i](#)

There are no RNA molecules in this entry.

5.4 Non-standard residues in protein, DNA, RNA chains [i](#)

There are no non-standard protein/DNA/RNA residues in this entry.

5.5 Carbohydrates [i](#)

There are no monosaccharides in this entry.

5.6 Ligand geometry [i](#)

4 ligands are modelled in this entry.

In the following table, the Counts columns list the number of bonds (or angles) for which Mogul statistics could be retrieved, the number of bonds (or angles) that are observed in the model and the number of bonds (or angles) that are defined in the Chemical Component Dictionary. The Link column lists molecule types, if any, to which the group is linked. The Z score for a bond length (or angle) is the number of standard deviations the observed value is removed from the expected value. A bond length (or angle) with $|Z| > 2$ is considered an outlier worth inspection. RMSZ is the root-mean-square of all Z scores of the bond lengths (or angles).

Mol	Type	Chain	Res	Link	Bond lengths			Bond angles		
					Counts	RMSZ	# Z > 2	Counts	RMSZ	# Z > 2
2	9NF	A	2002	-	27,28,30	3.19	11 (40%)	37,40,43	1.59	8 (21%)
2	9NF	B	2002	-	27,28,30	3.09	12 (44%)	37,40,43	1.66	9 (24%)

Mol	Type	Chain	Res	Link	Bond lengths			Bond angles		
					Counts	RMSZ	# Z > 2	Counts	RMSZ	# Z > 2
2	9NF	A	2001	-	27,28,30	2.48	15 (55%)	37,40,43	1.35	4 (10%)
2	9NF	B	2001	-	27,28,30	2.71	13 (48%)	37,40,43	1.19	5 (13%)

In the following table, the Chirals column lists the number of chiral outliers, the number of chiral centers analysed, the number of these observed in the model and the number defined in the Chemical Component Dictionary. Similar counts are reported in the Torsion and Rings columns. '-' means no outliers of that kind were identified.

Mol	Type	Chain	Res	Link	Chirals	Torsions	Rings
2	9NF	A	2002	-	-	2/19/19/23	0/3/3/3
2	9NF	B	2002	-	-	6/19/19/23	0/3/3/3
2	9NF	A	2001	-	-	0/19/19/23	0/3/3/3
2	9NF	B	2001	-	-	0/19/19/23	0/3/3/3

All (51) bond length outliers are listed below:

Mol	Chain	Res	Type	Atoms	Z	Observed(Å)	Ideal(Å)
2	A	2002	9NF	C1-S1	8.95	1.87	1.77
2	B	2002	9NF	C1-S1	8.53	1.86	1.77
2	A	2002	9NF	C1-C6	6.57	1.54	1.43
2	B	2001	9NF	C1-S1	6.46	1.84	1.77
2	B	2002	9NF	C1-C6	6.42	1.53	1.43
2	A	2002	9NF	C6-C5	5.38	1.53	1.43
2	B	2002	9NF	C6-C5	5.21	1.53	1.43
2	B	2001	9NF	C6-C5	5.13	1.52	1.43
2	B	2001	9NF	C9-C10	4.66	1.47	1.38
2	A	2002	9NF	C8-C9	4.48	1.48	1.38
2	A	2001	9NF	C1-C6	4.45	1.50	1.43
2	A	2001	9NF	C9-C10	4.39	1.47	1.38
2	B	2002	9NF	C8-C9	4.32	1.48	1.38
2	B	2002	9NF	C9-C10	4.18	1.46	1.38
2	B	2001	9NF	C1-C6	4.11	1.50	1.43
2	B	2001	9NF	C8-C9	4.00	1.47	1.38
2	A	2001	9NF	C8-C9	3.98	1.47	1.38
2	A	2002	9NF	C9-C10	3.94	1.46	1.38
2	A	2001	9NF	C6-C5	3.57	1.50	1.43
2	A	2002	9NF	C3-C2	3.50	1.46	1.38
2	B	2001	9NF	C3-C2	3.23	1.45	1.38
2	A	2001	9NF	CD2-CG	3.21	1.45	1.38
2	B	2002	9NF	C8-C7	3.17	1.43	1.36
2	A	2002	9NF	C8-C7	3.13	1.43	1.36

Continued on next page...

Continued from previous page...

Mol	Chain	Res	Type	Atoms	Z	Observed(Å)	Ideal(Å)
2	A	2002	9NF	S1-N	3.09	1.67	1.61
2	B	2002	9NF	C2-C1	3.08	1.41	1.37
2	A	2002	9NF	C2-C1	3.03	1.41	1.37
2	B	2002	9NF	C3-C2	3.00	1.45	1.38
2	B	2002	9NF	S1-N	2.99	1.66	1.61
2	A	2001	9NF	C7-C6	2.94	1.48	1.42
2	B	2002	9NF	CD2-CG	2.91	1.45	1.38
2	A	2001	9NF	C8-C7	2.83	1.43	1.36
2	A	2001	9NF	O3-S1	2.82	1.46	1.43
2	B	2001	9NF	C2-C1	2.78	1.40	1.37
2	A	2002	9NF	O3-S1	2.76	1.46	1.43
2	B	2001	9NF	C10-C5	2.73	1.49	1.42
2	B	2001	9NF	CD2-CG	2.71	1.44	1.38
2	B	2002	9NF	C10-C5	2.66	1.49	1.42
2	A	2001	9NF	C10-C5	2.64	1.49	1.42
2	A	2001	9NF	S1-N	2.63	1.66	1.61
2	A	2002	9NF	C10-C5	2.60	1.48	1.42
2	A	2001	9NF	C4-C5	2.40	1.47	1.42
2	B	2001	9NF	C4-C5	2.31	1.47	1.42
2	A	2001	9NF	CE2-CD2	2.20	1.43	1.38
2	B	2001	9NF	CZ-CE1	2.20	1.43	1.38
2	B	2001	9NF	C8-C7	2.16	1.41	1.36
2	B	2001	9NF	S1-N	2.15	1.65	1.61
2	A	2001	9NF	C11-N1	2.13	1.50	1.45
2	B	2002	9NF	O3-S1	2.09	1.45	1.43
2	A	2001	9NF	CD1-CG	2.05	1.43	1.38
2	A	2001	9NF	C1-S1	2.05	1.80	1.77

All (26) bond angle outliers are listed below:

Mol	Chain	Res	Type	Atoms	Z	Observed(°)	Ideal(°)
2	B	2002	9NF	C12-N1-C11	-3.94	103.43	116.12
2	B	2002	9NF	C-CA-CB	-3.88	103.92	111.91
2	A	2001	9NF	CG-CB-CA	3.82	120.22	113.39
2	A	2002	9NF	C-CA-CB	-3.60	104.50	111.91
2	A	2002	9NF	C12-N1-C11	-3.53	104.76	116.12
2	A	2001	9NF	C12-N1-C11	-3.49	104.89	116.12
2	B	2002	9NF	CG-CB-CA	3.31	119.31	113.39
2	B	2002	9NF	CB-CA-N	3.22	114.91	110.24
2	B	2001	9NF	C12-N1-C11	-3.16	105.93	116.12
2	B	2001	9NF	C-CA-CB	-2.96	105.81	111.91
2	A	2002	9NF	C10-C5-C6	2.92	122.48	119.33

Continued on next page...

Continued from previous page...

Mol	Chain	Res	Type	Atoms	Z	Observed(°)	Ideal(°)
2	A	2002	9NF	O3-S1-O2	-2.83	116.07	119.55
2	B	2002	9NF	O3-S1-O2	-2.62	116.33	119.55
2	A	2002	9NF	C6-C1-S1	2.54	124.61	121.58
2	B	2002	9NF	C7-C6-C1	2.53	126.91	123.60
2	A	2001	9NF	O2-S1-C1	2.50	112.49	108.08
2	A	2002	9NF	C4-C5-C10	-2.49	118.45	122.74
2	B	2002	9NF	C10-C5-C6	2.48	122.01	119.33
2	A	2001	9NF	CB-CA-N	-2.48	106.65	110.24
2	A	2002	9NF	CG-CB-CA	2.47	117.81	113.39
2	B	2001	9NF	C9-C10-N1	2.44	125.36	121.68
2	A	2002	9NF	C7-C6-C1	2.31	126.63	123.60
2	B	2002	9NF	C6-C1-S1	2.22	124.23	121.58
2	B	2001	9NF	CG-CB-CA	2.14	117.21	113.39
2	B	2002	9NF	C4-C5-C10	-2.12	119.08	122.74
2	B	2001	9NF	O3-S1-O2	-2.08	117.00	119.55

There are no chirality outliers.

All (8) torsion outliers are listed below:

Mol	Chain	Res	Type	Atoms
2	A	2002	9NF	N-CA-CB-CG
2	B	2002	9NF	N-CA-CB-CG
2	B	2002	9NF	C-CA-CB-CG
2	B	2002	9NF	CA-N-S1-O3
2	B	2002	9NF	CA-N-S1-C1
2	B	2002	9NF	CA-CB-CG-CD1
2	B	2002	9NF	CA-CB-CG-CD2
2	A	2002	9NF	CA-N-S1-O3

There are no ring outliers.

4 monomers are involved in 31 short contacts:

Mol	Chain	Res	Type	Clashes	Symm-Clashes
2	A	2002	9NF	15	0
2	B	2002	9NF	11	0
2	A	2001	9NF	2	0
2	B	2001	9NF	3	0

The following is a two-dimensional graphical depiction of Mogul quality analysis of bond lengths, bond angles, torsion angles, and ring geometry for all instances of the Ligand of Interest. In addition, ligands with molecular weight > 250 and outliers as shown on the validation Tables will

also be included. For torsion angles, if less than 5% of the Mogul distribution of torsion angles is within 10 degrees of the torsion angle in question, then that torsion angle is considered an outlier. Any bond that is central to one or more torsion angles identified as an outlier by Mogul will be highlighted in the graph. For rings, the root-mean-square deviation (RMSD) between the ring in question and similar rings identified by Mogul is calculated over all ring torsion angles. If the average RMSD is greater than 60 degrees and the minimal RMSD between the ring in question and any Mogul-identified rings is also greater than 60 degrees, then that ring is considered an outlier. The outliers are highlighted in purple. The color gray indicates Mogul did not find sufficient equivalents in the CSD to analyse the geometry.

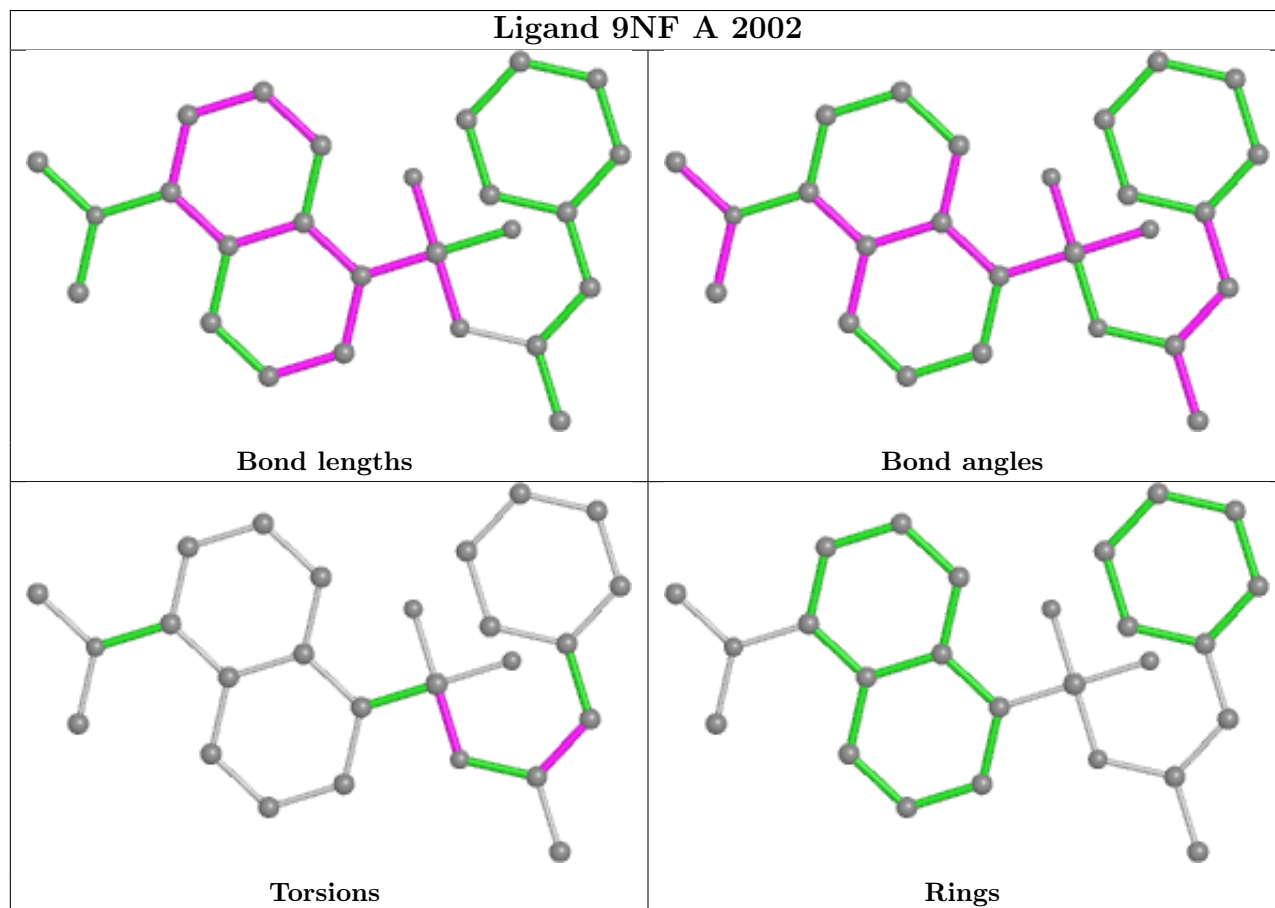

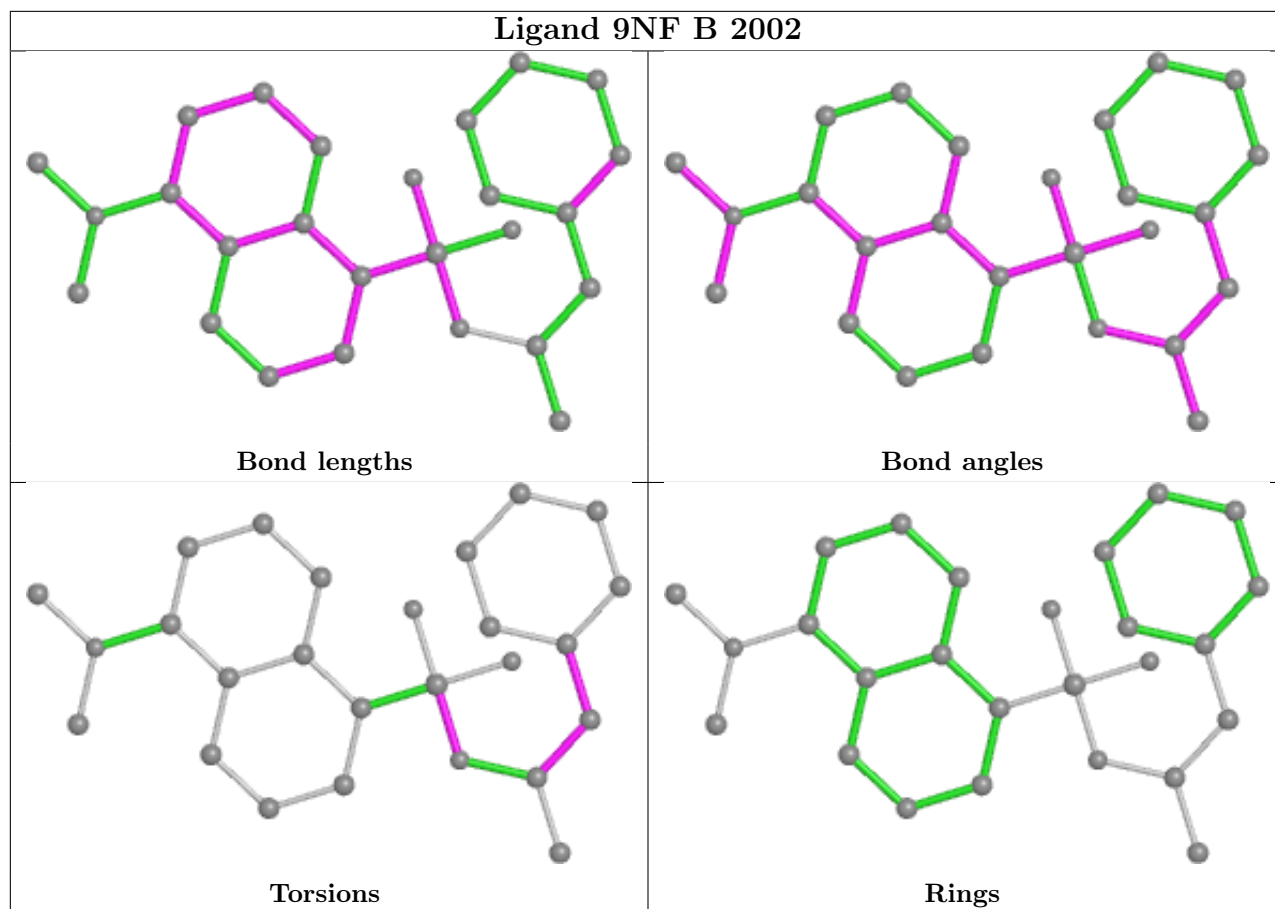

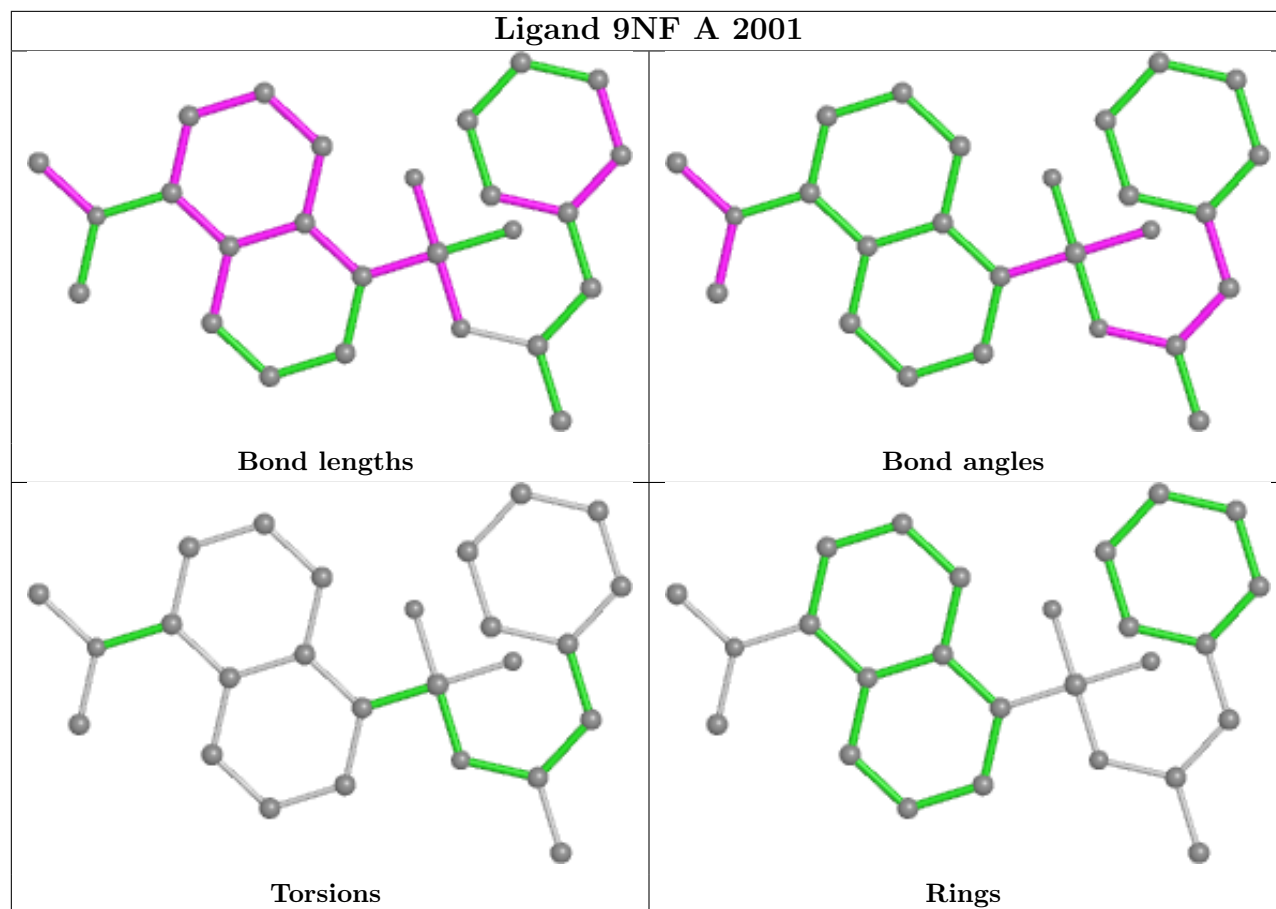

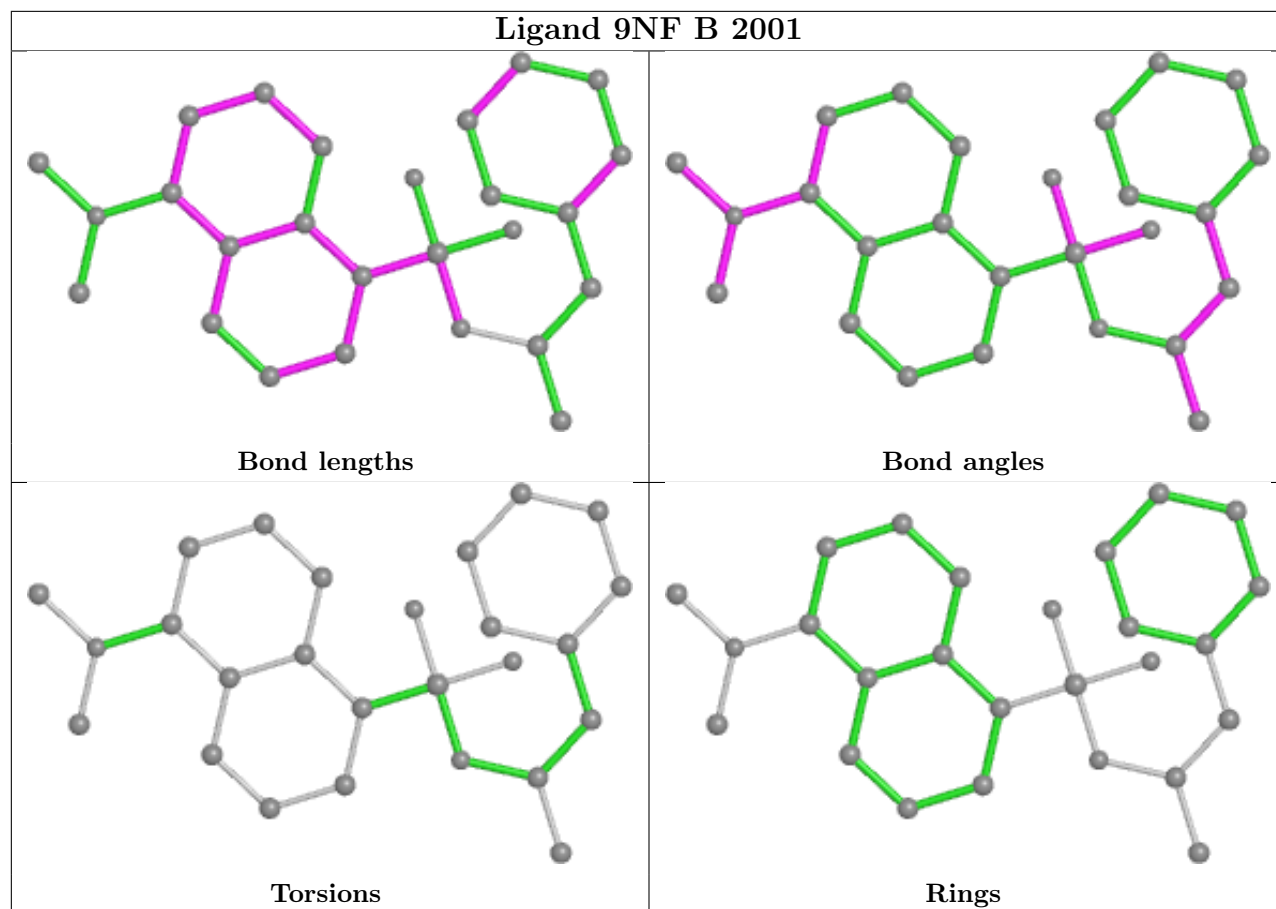

5.7 Other polymers [i](#)

There are no such residues in this entry.

5.8 Polymer linkage issues [i](#)

There are no chain breaks in this entry.

6 Fit of model and data

6.1 Protein, DNA and RNA chains

In the following table, the column labelled ‘#RSRZ > 2’ contains the number (and percentage) of RSRZ outliers, followed by percent RSRZ outliers for the chain as percentile scores relative to all X-ray entries and entries of similar resolution. The OWAB column contains the minimum, median, 95th percentile and maximum values of the occupancy-weighted average B-factor per residue. The column labelled ‘Q < 0.9’ lists the number of (and percentage) of residues with an average occupancy less than 0.9.

Mol	Chain	Analysed	<RSRZ>	#RSRZ>2	OWAB(Å ²)	Q<0.9
1	A	569/585 (97%)	-0.05	21 (3%) 41 41	30, 64, 140, 153	0
1	B	566/585 (96%)	-0.04	24 (4%) 36 35	30, 68, 134, 156	0
All	All	1135/1170 (97%)	-0.05	45 (3%) 38 37	30, 65, 138, 156	0

All (45) RSRZ outliers are listed below:

Mol	Chain	Res	Type	RSRZ
1	A	569	ALA	7.4
1	A	568	PHE	5.6
1	A	509	PHE	5.6
1	B	54	VAL	5.4
1	B	566	THR	5.1
1	B	504	ALA	4.7
1	B	509	PHE	4.5
1	A	506	THR	4.3
1	B	578	ALA	4.2
1	B	577	ALA	4.1
1	A	558	CYS	4.1
1	A	559	CYS	3.9
1	B	560	LYS	3.9
1	A	508	THR	3.9
1	A	582	ALA	3.8
1	B	510	HIS	3.8
1	A	507	PHE	3.7
1	A	504	ALA	3.7
1	B	513	ILE	3.6
1	B	575	LEU	3.4
1	A	578	ALA	3.3
1	B	559	CYS	3.3
1	A	161	TYR	3.2
1	B	558	CYS	3.2

Continued on next page...

Continued from previous page...

Mol	Chain	Res	Type	RSRZ
1	A	91	CYS	3.1
1	B	579	SER	2.9
1	A	505	GLU	2.9
1	A	513	ILE	2.9
1	B	161	TYR	2.6
1	A	560	LYS	2.6
1	B	582	ALA	2.6
1	B	508	THR	2.5
1	B	45	GLU	2.4
1	A	566	THR	2.3
1	B	516	LEU	2.3
1	B	176	ALA	2.3
1	A	577	ALA	2.2
1	A	555	VAL	2.2
1	A	557	LYS	2.2
1	B	46	VAL	2.2
1	B	171	ALA	2.2
1	A	561	ALA	2.1
1	B	576	VAL	2.1
1	B	55	ALA	2.1
1	B	564	LYS	2.0

6.2 Non-standard residues in protein, DNA, RNA chains [i](#)

There are no non-standard protein/DNA/RNA residues in this entry.

6.3 Carbohydrates [i](#)

There are no monosaccharides in this entry.

6.4 Ligands [i](#)

In the following table, the Atoms column lists the number of modelled atoms in the group and the number defined in the chemical component dictionary. The B-factors column lists the minimum, median, 95th percentile and maximum values of B factors of atoms in the group. The column labelled 'Q< 0.9' lists the number of atoms with occupancy less than 0.9.

Mol	Type	Chain	Res	Atoms	RSCC	RSR	B-factors(\AA^2)	Q<0.9
2	9NF	A	2002	26/28	0.89	0.24	68,72,75,77	0
2	9NF	B	2002	26/28	0.92	0.26	66,70,75,79	0

Continued on next page...

Continued from previous page...

Mol	Type	Chain	Res	Atoms	RSCC	RSR	B-factors(\AA^2)	Q<0.9
2	9NF	B	2001	26/28	0.94	0.19	46,49,58,59	0
2	9NF	A	2001	26/28	0.96	0.19	41,46,60,61	0

The following is a graphical depiction of the model fit to experimental electron density of all instances of the Ligand of Interest. In addition, ligands with molecular weight > 250 and outliers as shown on the geometry validation Tables will also be included. Each fit is shown from different orientation to approximate a three-dimensional view.

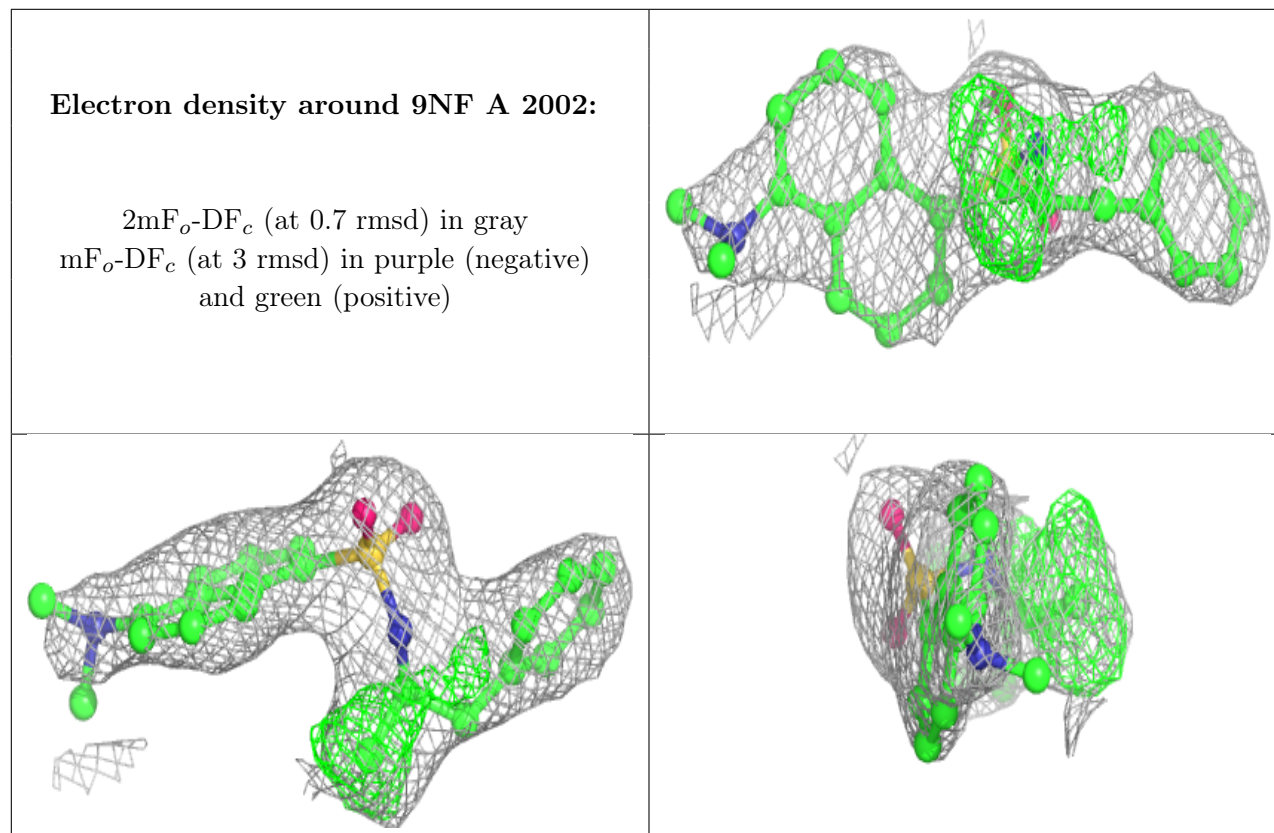

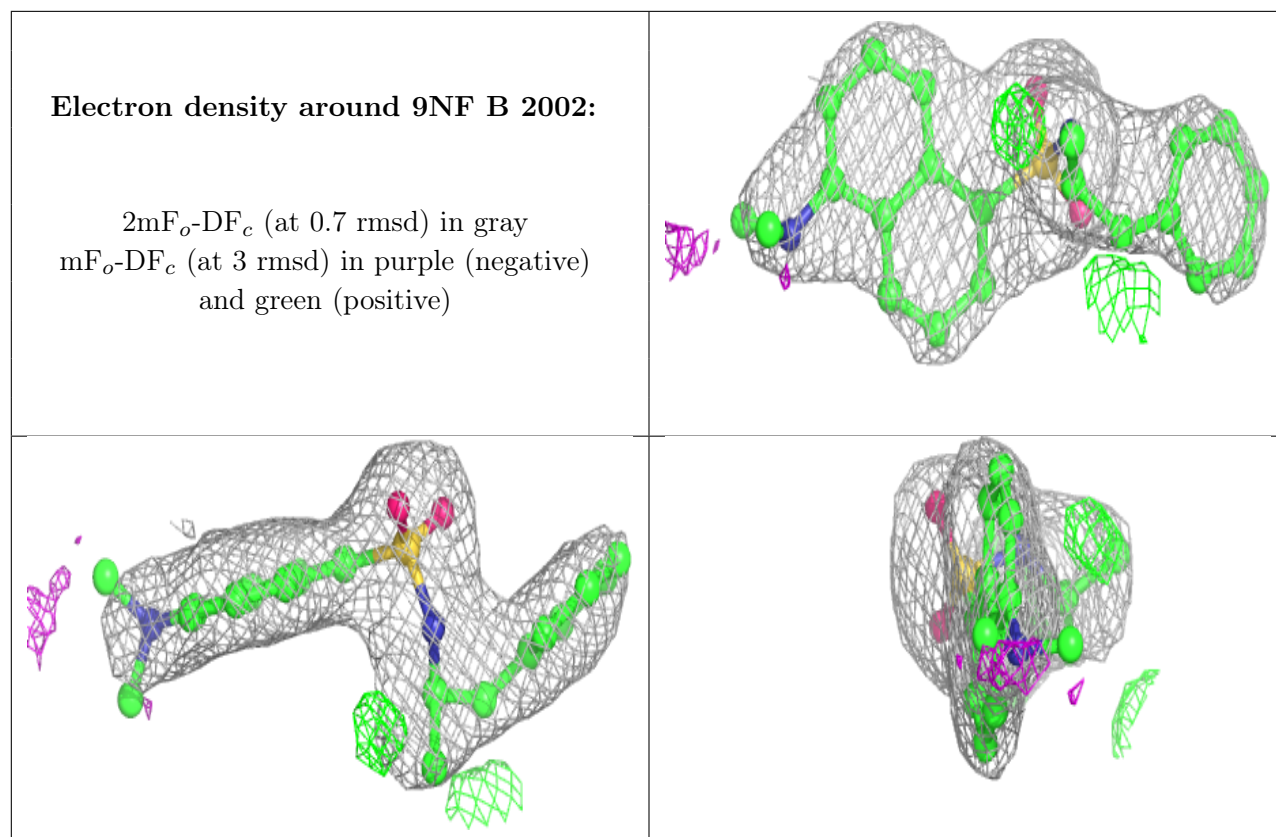

Electron density around 9NF B 2001:

$2mF_o-DF_c$ (at 0.7 rmsd) in gray
 mF_o-DF_c (at 3 rmsd) in purple (negative)
and green (positive)

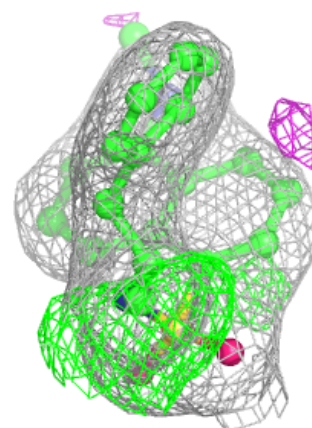
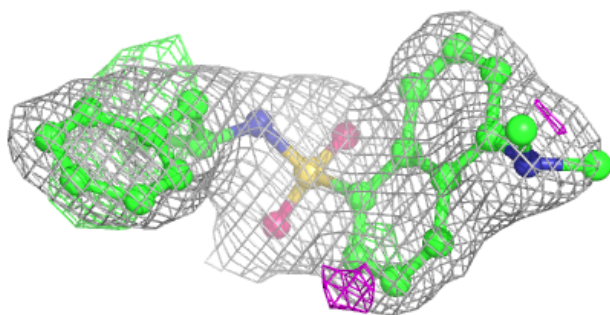
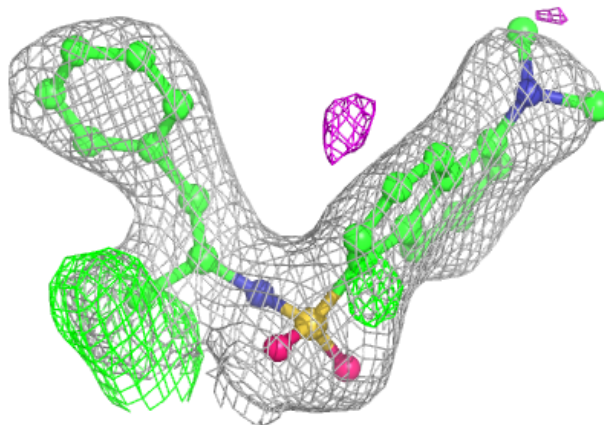

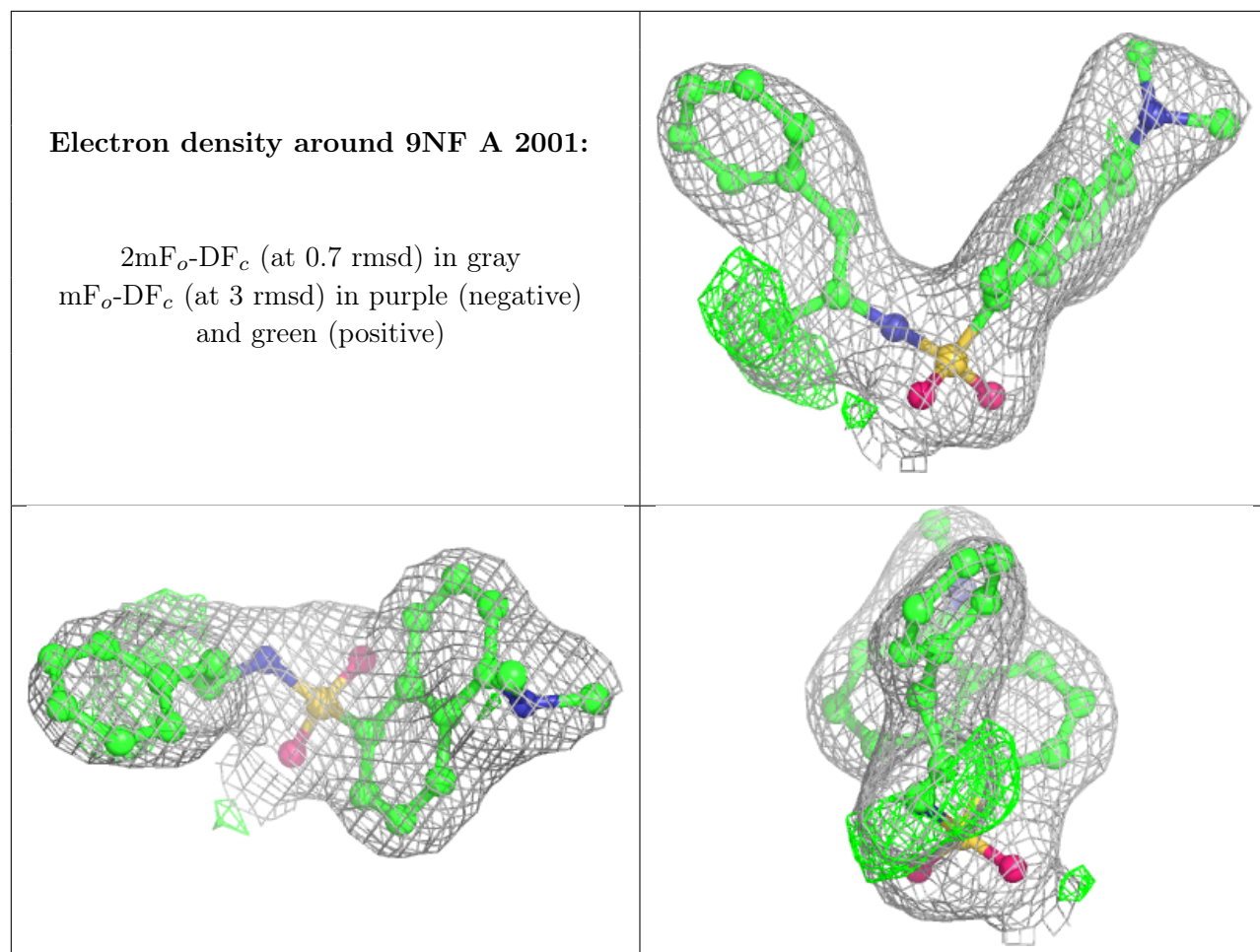

6.5 Other polymers [i](#)

There are no such residues in this entry.