



# Full wwPDB X-ray Structure Validation Report ⓘ

Dec 5, 2023 – 05:41 am GMT

PDB ID : 1QPB  
Title : PYRUVATE DECARBOXYLASE FROM YEAST (FORM B) COMPLEXED WITH PYRUVAMIDE  
Authors : Lu, G.; Dobritzsch, D.; Schneider, G.  
Deposited on : 1999-11-26  
Resolution : 2.40 Å(reported)

This is a Full wwPDB X-ray Structure Validation Report for a publicly released PDB entry.

We welcome your comments at [validation@mail.wwpdb.org](mailto:validation@mail.wwpdb.org)

A user guide is available at

<https://www.wwpdb.org/validation/2017/XrayValidationReportHelp>

with specific help available everywhere you see the ⓘ symbol.

The types of validation reports are described at

<http://www.wwpdb.org/validation/2017/FAQs#types>.

---

The following versions of software and data (see [references ⓘ](#)) were used in the production of this report:

MolProbity : 4.02b-467  
Mogul : 1.8.4, CSD as541be (2020)  
Xtriage (Phenix) : 1.13  
EDS : 2.36  
buster-report : 1.1.7 (2018)  
Percentile statistics : 20191225.v01 (using entries in the PDB archive December 25th 2019)  
Refmac : 5.8.0158  
CCP4 : 7.0.044 (Gargrove)  
Ideal geometry (proteins) : Engh & Huber (2001)  
Ideal geometry (DNA, RNA) : Parkinson et al. (1996)  
Validation Pipeline (wwPDB-VP) : 2.36

# 1 Overall quality at a glance

The following experimental techniques were used to determine the structure:

*X-RAY DIFFRACTION*

The reported resolution of this entry is 2.40 Å.

Percentile scores (ranging between 0-100) for global validation metrics of the entry are shown in the following graphic. The table shows the number of entries on which the scores are based.

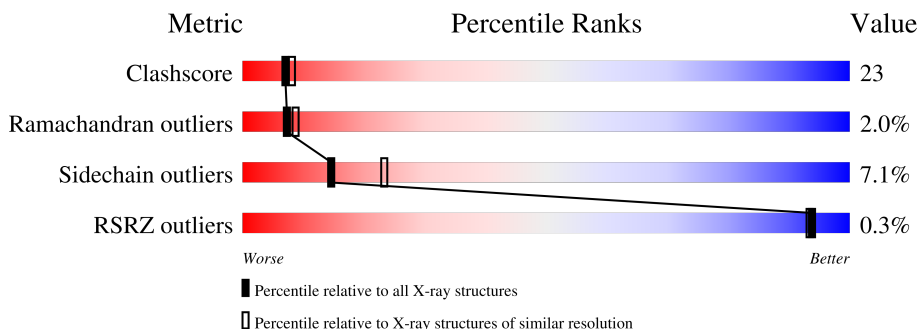

Metric	Whole archive (#Entries)	Similar resolution (#Entries, resolution range(Å))
Clashscore	141614	4398 (2.40-2.40)
Ramachandran outliers	138981	4318 (2.40-2.40)
Sidechain outliers	138945	4319 (2.40-2.40)
RSRZ outliers	127900	3811 (2.40-2.40)

The table below summarises the geometric issues observed across the polymeric chains and their fit to the electron density. The red, orange, yellow and green segments of the lower bar indicate the fraction of residues that contain outliers for  $\geq 3$ , 2, 1 and 0 types of geometric quality criteria respectively. A grey segment represents the fraction of residues that are not modelled. The numeric value for each fraction is indicated below the corresponding segment, with a dot representing fractions  $\leq 5\%$ . The upper red bar (where present) indicates the fraction of residues that have poor fit to the electron density. The numeric value is given above the bar.

Mol	Chain	Length	Quality of chain
1	A	563	 55% 39% . .
1	B	563	 % 59% 35% . .

## 2 Entry composition

There are 5 unique types of molecules in this entry. The entry contains 8757 atoms, of which 0 are hydrogens and 0 are deuteriums.

In the tables below, the ZeroOcc column contains the number of atoms modelled with zero occupancy, the AltConf column contains the number of residues with at least one atom in alternate conformation and the Trace column contains the number of residues modelled with at most 2 atoms.

- Molecule 1 is a protein called PYRUVATE DECARBOXYLASE (FORM B).

Mol	Chain	Residues	Atoms					ZeroOcc	AltConf	Trace
			Total	C	N	O	S			
1	A	555	Total	C	N	O	S	75	0	0
			4275	2734	714	811	16			
1	B	555	Total	C	N	O	S	126	0	0
			4275	2734	714	811	16			

There are 8 discrepancies between the modelled and reference sequences:

Chain	Residue	Modelled	Actual	Comment	Reference
A	206	VAL	ALA	variant	UNP P06169
A	208	ILE	VAL	variant	UNP P06169
A	336	ALA	THR	variant	UNP P06169
A	538	VAL	ILE	variant	UNP P06169
B	206	VAL	ALA	variant	UNP P06169
B	208	ILE	VAL	variant	UNP P06169
B	336	ALA	THR	variant	UNP P06169
B	538	VAL	ILE	variant	UNP P06169

- Molecule 2 is THIAMINE DIPHOSPHATE (three-letter code: TPP) (formula: C<sub>12</sub>H<sub>19</sub>N<sub>4</sub>O<sub>7</sub>P<sub>2</sub>S).



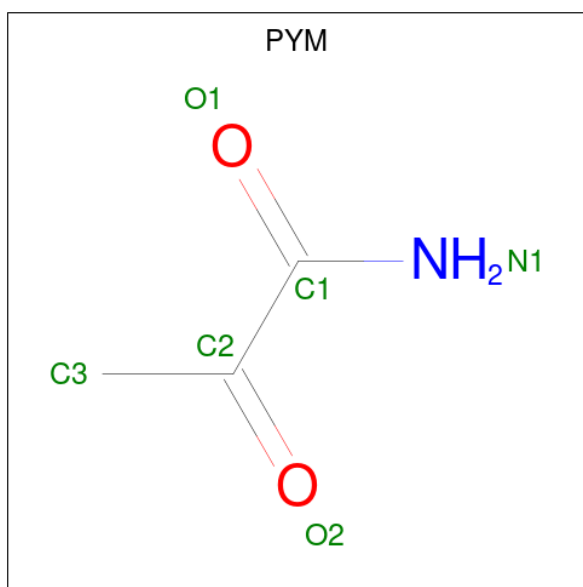

Mol	Chain	Residues	Atoms				ZeroOcc	AltConf
4	A	1	Total	C	N	O	0	0
			6	3	1	2		
4	B	1	Total	C	N	O	0	0
			6	3	1	2		

- Molecule 5 is water.

Mol	Chain	Residues	Atoms		ZeroOcc	AltConf
5	A	85	Total	O	0	0
			85	85		
5	B	56	Total	O	0	0
			56	56		



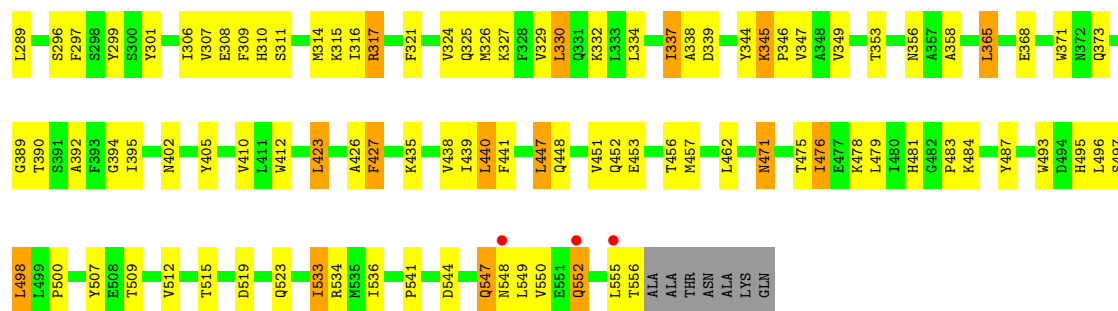

## 4 Data and refinement statistics

Property	Value	Source
Space group	C 1 2 1	Depositor
Cell constants a, b, c, $\alpha$ , $\beta$ , $\gamma$	145.05Å 119.70Å 81.28Å 90.00° 120.21° 90.00°	Depositor
Resolution (Å)	15.00 – 2.40 24.46 – 2.39	Depositor EDS
% Data completeness (in resolution range)	89.0 (15.00-2.40) 89.4 (24.46-2.39)	Depositor EDS
$R_{merge}$	0.11	Depositor
$R_{sym}$	0.09	Depositor
$\langle I/\sigma(I) \rangle$ <sup>1</sup>	1.40 (at 2.39Å)	Xtrriage
Refinement program	CNS 3.8	Depositor
R, $R_{free}$	0.233 , 0.287 0.227 , (Not available)	Depositor DCC
$R_{free}$ test set	No test flags present.	wwPDB-VP
Wilson B-factor (Å <sup>2</sup> )	29.3	Xtrriage
Anisotropy	0.208	Xtrriage
Bulk solvent $k_{sol}$ (e/Å <sup>3</sup> ), $B_{sol}$ (Å <sup>2</sup> )	0.30 , 27.6	EDS
L-test for twinning <sup>2</sup>	$\langle  L  \rangle = 0.45$ , $\langle L^2 \rangle = 0.27$	Xtrriage
Estimated twinning fraction	No twinning to report.	Xtrriage
$F_o, F_c$ correlation	0.92	EDS
Total number of atoms	8757	wwPDB-VP
Average B, all atoms (Å <sup>2</sup> )	35.0	wwPDB-VP

Xtrriage's analysis on translational NCS is as follows: *The largest off-origin peak in the Patterson function is 5.40% of the height of the origin peak. No significant pseudotranslation is detected.*

<sup>1</sup>Intensities estimated from amplitudes.

<sup>2</sup>Theoretical values of  $\langle |L| \rangle$ ,  $\langle L^2 \rangle$  for acentric reflections are 0.5, 0.333 respectively for untwinned datasets, and 0.375, 0.2 for perfectly twinned datasets.



## 5 Model quality [i](#)

### 5.1 Standard geometry [i](#)

Bond lengths and bond angles in the following residue types are not validated in this section: TPP, MG, PYM

The Z score for a bond length (or angle) is the number of standard deviations the observed value is removed from the expected value. A bond length (or angle) with  $|Z| > 5$  is considered an outlier worth inspection. RMSZ is the root-mean-square of all Z scores of the bond lengths (or angles).

Mol	Chain	Bond lengths		Bond angles	
		RMSZ	# Z  >5	RMSZ	# Z  >5
1	A	0.41	0/4366	0.66	0/5937
1	B	0.38	0/4366	0.63	1/5937 (0.0%)
All	All	0.40	0/8732	0.64	1/11874 (0.0%)

There are no bond length outliers.

All (1) bond angle outliers are listed below:

Mol	Chain	Res	Type	Atoms	Z	Observed(°)	Ideal(°)
1	B	423	LEU	CA-CB-CG	5.55	128.07	115.30

There are no chirality outliers.

There are no planarity outliers.

### 5.2 Too-close contacts [i](#)

In the following table, the Non-H and H(model) columns list the number of non-hydrogen atoms and hydrogen atoms in the chain respectively. The H(added) column lists the number of hydrogen atoms added and optimized by MolProbity. The Clashes column lists the number of clashes within the asymmetric unit, whereas Symm-Clashes lists symmetry-related clashes.

Mol	Chain	Non-H	H(model)	H(added)	Clashes	Symm-Clashes
1	A	4275	0	4287	215	0
1	B	4275	0	4287	183	0
2	A	26	0	16	1	0
2	B	26	0	16	2	0
3	A	1	0	0	0	0
3	B	1	0	0	0	0
4	A	6	0	5	0	0
4	B	6	0	5	1	0

*Continued on next page...*

*Continued from previous page...*

Mol	Chain	Non-H	H(model)	H(added)	Clashes	Symm-Clashes
5	A	85	0	0	8	0
5	B	56	0	0	3	0
All	All	8757	0	8616	383	0

The all-atom clashscore is defined as the number of clashes found per 1000 atoms (including hydrogen atoms). The all-atom clashscore for this structure is 23.

All (383) close contacts within the same asymmetric unit are listed below, sorted by their clash magnitude.

Atom-1	Atom-2	Interatomic distance (Å)	Clash overlap (Å)
1:B:533:ILE:HD12	1:B:533:ILE:H	1.22	1.04
1:B:267:LEU:HD21	1:B:552:GLN:HB3	1.37	1.04
1:A:533:ILE:HD12	1:A:533:ILE:H	1.24	1.01
1:B:496:LEU:HD22	1:B:509:THR:HB	1.51	0.92
1:B:224:ARG:HD2	1:B:405:TYR:OH	1.70	0.92
1:A:294:THR:HG22	1:A:296:SER:H	1.37	0.90
1:A:233:LYS:HG2	1:A:334:LEU:HD22	1.52	0.88
1:B:101:VAL:HG13	1:B:102:PRO:HD2	1.56	0.87
1:A:269:LYS:HB2	1:A:272:VAL:HG23	1.58	0.85
1:A:203:THR:O	1:A:207:LEU:HD13	1.74	0.85
1:A:34:LEU:O	1:A:37:ILE:HG22	1.75	0.84
1:A:308:GLU:HB2	1:A:315:LYS:HB3	1.59	0.83
1:B:13:ARG:HG3	1:B:185:ILE:HD11	1.59	0.83
1:A:136:THR:HG22	1:A:164:TYR:HB3	1.58	0.83
1:B:233:LYS:HD3	1:B:334:LEU:HD13	1.59	0.83
1:A:116:THR:HG21	1:A:122:PHE:HE1	1.45	0.81
1:A:373:GLN:HA	1:A:373:GLN:HE21	1.45	0.81
1:A:481:HIS:HB3	1:B:31:LEU:HD23	1.63	0.80
1:A:12:GLU:HG2	1:A:181:LEU:HD13	1.65	0.79
1:B:30:ASN:C	1:B:30:ASN:HD22	1.85	0.79
1:A:462:LEU:O	1:A:533:ILE:HG13	1.83	0.79
1:A:198:LYS:HD3	1:A:199:GLU:N	1.98	0.78
1:B:325:GLN:O	1:B:329:VAL:HG23	1.85	0.77
1:A:324:VAL:HG12	1:A:329:VAL:HG21	1.66	0.76
1:B:109:LYS:HB2	1:B:109:LYS:NZ	2.02	0.74
1:B:197:GLU:OE2	1:B:332:LYS:HG3	1.87	0.74
1:A:541:PRO:HG2	1:A:544:ASP:HB2	1.71	0.72
1:A:142:ILE:HD12	1:A:143:ALA:N	2.04	0.72
1:A:541:PRO:HG2	1:A:544:ASP:CB	2.18	0.72
1:A:411:LEU:HD11	1:B:113:LEU:HD22	1.71	0.72
1:A:15:LYS:HZ1	1:A:42:GLY:HA3	1.55	0.72

*Continued on next page...*

*Continued from previous page...*

Atom-1	Atom-2	Interatomic distance (Å)	Clash overlap (Å)
1:B:330:LEU:O	1:B:334:LEU:HG	1.89	0.72
1:B:198:LYS:HD3	1:B:199:GLU:N	2.06	0.71
1:A:360:PRO:HG2	1:A:363:THR:CG2	2.21	0.70
1:A:141:ASP:OD2	1:A:143:ALA:HB3	1.91	0.70
1:A:145:ALA:N	1:A:146:PRO:HD2	2.07	0.70
1:B:126:HIS:HE1	1:B:136:THR:HB	1.56	0.70
1:A:31:LEU:HD23	1:B:481:HIS:HB3	1.75	0.69
1:A:204:ILE:HG22	1:A:208:ILE:HD11	1.74	0.68
1:B:227:VAL:HG11	1:B:326:MET:CE	2.23	0.68
1:B:552:GLN:HA	1:B:555:LEU:HD21	1.76	0.68
1:B:440:LEU:HD22	1:B:441:PHE:N	2.09	0.67
1:B:495:HIS:O	1:B:498:LEU:HB2	1.95	0.67
1:A:15:LYS:NZ	1:A:42:GLY:HA3	2.10	0.67
1:A:427:PHE:CE1	1:A:462:LEU:HD11	2.30	0.66
1:A:197:GLU:HG3	1:A:329:VAL:HG22	1.76	0.66
1:A:294:THR:CG2	1:A:296:SER:H	2.09	0.65
1:B:365:LEU:HD13	1:B:512:VAL:HG12	1.77	0.65
1:A:201:ILE:O	1:A:205:LEU:HD23	1.96	0.65
1:B:308:GLU:HB2	1:B:315:LYS:HB3	1.78	0.65
1:A:114:HIS:O	1:A:115:HIS:HB2	1.97	0.65
1:B:15:LYS:HZ1	1:B:42:GLY:HA3	1.62	0.64
1:B:27:GLY:H	1:B:30:ASN:HD21	1.46	0.64
1:A:514:THR:OG1	1:A:517:GLU:HG3	1.98	0.64
1:A:171:LEU:HD23	1:A:174:LEU:HD12	1.80	0.64
1:A:440:LEU:HD22	1:A:441:PHE:N	2.12	0.64
1:A:533:ILE:H	1:A:533:ILE:CD1	2.02	0.64
1:B:555:LEU:HD23	1:B:555:LEU:H	1.63	0.63
1:B:13:ARG:CG	1:B:185:ILE:HD11	2.28	0.63
1:A:204:ILE:O	1:A:208:ILE:HG13	1.97	0.63
1:A:281:LEU:HD12	1:A:282:ILE:H	1.63	0.63
1:A:360:PRO:O	1:A:363:THR:HG23	1.98	0.63
1:A:512:VAL:HG11	1:A:518:TRP:HB2	1.80	0.63
1:A:220:ALA:HB2	1:A:247:MET:HB3	1.80	0.62
1:A:223:SER:HB3	1:A:251:SER:HB3	1.81	0.62
1:A:415:ILE:HG13	1:A:449:LEU:HD22	1.81	0.62
1:A:142:ILE:HD12	1:A:143:ALA:H	1.64	0.62
1:B:533:ILE:H	1:B:533:ILE:CD1	1.99	0.62
1:B:267:LEU:HD22	1:B:548:ASN:O	2.00	0.62
1:A:508:GLU:HB3	1:A:534:ARG:HG2	1.82	0.61
1:B:201:ILE:O	1:B:202:ASP:C	2.39	0.61
1:B:145:ALA:N	1:B:146:PRO:HD2	2.16	0.61

*Continued on next page...*

*Continued from previous page...*

Atom-1	Atom-2	Interatomic distance (Å)	Clash overlap (Å)
1:B:20:ASN:HD22	1:B:65:LYS:HZ1	1.49	0.61
1:B:109:LYS:HB2	1:B:109:LYS:HZ2	1.66	0.61
1:A:192:ASN:HD21	1:A:325:GLN:HE21	1.46	0.61
1:B:314:MET:HB2	1:B:321:PHE:HB2	1.83	0.61
1:B:201:ILE:HG22	1:B:202:ASP:N	2.15	0.60
1:A:464:PRO:HD2	1:A:533:ILE:HG23	1.81	0.60
1:B:15:LYS:NZ	1:B:42:GLY:HA3	2.16	0.60
1:B:190:LYS:H	1:B:190:LYS:HD2	1.65	0.60
1:A:11:PHE:HE1	1:A:22:VAL:HG21	1.66	0.60
1:A:365:LEU:CD1	1:A:512:VAL:HG12	2.31	0.60
1:B:471:ASN:ND2	1:B:475:THR:HG21	2.17	0.59
1:A:373:GLN:HA	1:A:373:GLN:NE2	2.14	0.59
1:B:190:LYS:HD2	1:B:190:LYS:N	2.16	0.59
1:B:101:VAL:HG13	1:B:102:PRO:CD	2.32	0.59
1:B:224:ARG:CD	1:B:405:TYR:OH	2.47	0.59
1:B:365:LEU:CD1	1:B:512:VAL:HG12	2.33	0.59
1:A:198:LYS:HE2	1:A:202:ASP:OD2	2.03	0.59
1:A:238:THR:O	1:A:239:GLN:HB2	2.01	0.59
1:B:447:LEU:HD22	1:B:451:VAL:HG23	1.84	0.59
1:A:197:GLU:OE2	1:A:332:LYS:HG3	2.02	0.59
1:A:495:HIS:O	1:A:498:LEU:HB2	2.03	0.59
1:B:238:THR:O	1:B:239:GLN:HB2	2.03	0.59
1:B:462:LEU:O	1:B:533:ILE:HG13	2.03	0.59
1:A:132:ILE:HG22	1:B:117:LEU:HD21	1.85	0.59
1:B:536:ILE:N	1:B:536:ILE:HD12	2.18	0.58
1:A:496:LEU:HD22	1:A:509:THR:HB	1.85	0.58
1:B:541:PRO:HB2	1:B:544:ASP:HB2	1.85	0.58
1:A:281:LEU:HD12	1:A:282:ILE:N	2.18	0.58
1:B:547:GLN:O	1:B:550:VAL:HG22	2.04	0.57
1:A:24:GLY:C	1:A:25:LEU:HD12	2.24	0.57
1:A:444:ASP:OD2	1:A:490:ILE:HD11	2.03	0.57
1:B:247:MET:HB2	1:B:289:LEU:HD11	1.86	0.57
1:B:96:LEU:HD12	1:B:163:VAL:O	2.05	0.57
1:B:371:TRP:CE2	1:B:394:GLY:HA3	2.40	0.57
1:A:499:LEU:N	1:A:500:PRO:HD2	2.20	0.56
1:A:37:ILE:HG23	1:A:38:TYR:N	2.20	0.56
1:B:264:VAL:CG2	1:B:267:LEU:HB2	2.35	0.56
1:B:478:LYS:HB3	1:B:483:PRO:HA	1.86	0.56
1:A:205:LEU:HA	1:A:208:ILE:HD12	1.88	0.56
1:B:259:TYR:CZ	1:B:261:GLY:HA2	2.41	0.56
1:A:228:LYS:HE2	1:A:251:SER:O	2.05	0.56

*Continued on next page...*

*Continued from previous page...*

Atom-1	Atom-2	Interatomic distance (Å)	Clash overlap (Å)
1:A:17:VAL:HG23	1:A:19:VAL:HG23	1.87	0.56
1:B:316:ILE:O	1:B:317:ARG:HB2	2.04	0.56
1:B:36:LYS:O	1:B:39:GLU:HB2	2.06	0.55
1:B:247:MET:CG	1:B:410:VAL:HB	2.35	0.55
1:B:30:ASN:C	1:B:30:ASN:ND2	2.57	0.55
1:A:74:PHE:HE2	1:A:116:THR:HG22	1.70	0.55
1:B:247:MET:SD	1:B:289:LEU:HD21	2.46	0.55
1:B:112:LEU:HD23	1:B:122:PHE:CE1	2.42	0.55
1:A:123:THR:O	1:A:127:ARG:HG3	2.07	0.55
1:B:12:GLU:HG2	1:B:181:LEU:HD13	1.89	0.55
1:B:202:ASP:O	1:B:206:VAL:HG23	2.06	0.55
1:B:126:HIS:HE1	1:B:136:THR:CB	2.20	0.55
1:A:11:PHE:HE2	1:A:33:LEU:HD22	1.72	0.54
1:A:357:ALA:O	1:A:359:VAL:HG13	2.07	0.54
1:A:550:VAL:O	1:A:550:VAL:HG22	2.07	0.54
1:B:337:ILE:HG23	5:B:2032:HOH:O	2.06	0.54
1:A:227:VAL:HG13	1:A:227:VAL:O	2.07	0.54
1:B:20:ASN:HD22	1:B:65:LYS:NZ	2.04	0.54
1:B:3:GLU:HB3	1:B:175:ASN:HB3	1.90	0.54
1:B:53:ASN:HB3	1:B:453:GLU:HG2	1.89	0.54
1:B:254:GLU:HG2	1:B:259:TYR:CE2	2.43	0.54
1:A:168:PRO:HD2	1:A:171:LEU:HD12	1.88	0.54
1:A:36:LYS:CD	1:A:36:LYS:N	2.71	0.53
1:B:211:ALA:HA	1:B:280:ASP:OD2	2.08	0.53
1:B:552:GLN:HA	1:B:555:LEU:CD2	2.38	0.53
1:A:139:ILE:HD12	1:A:167:LEU:HD12	1.90	0.53
1:B:136:THR:HG22	1:B:164:TYR:HB3	1.89	0.53
1:A:36:LYS:N	1:A:36:LYS:HD2	2.24	0.53
1:A:541:PRO:HG2	1:A:544:ASP:HB3	1.91	0.53
1:B:326:MET:O	1:B:330:LEU:HB2	2.08	0.53
1:A:3:GLU:HB3	1:A:175:ASN:HB3	1.90	0.53
1:A:277:GLU:HG2	1:A:302:LYS:HB2	1.90	0.53
1:A:480:ILE:O	1:A:481:HIS:HB2	2.08	0.53
1:A:76:VAL:HG23	1:A:77:GLY:N	2.24	0.53
1:A:373:GLN:HE21	1:A:373:GLN:CA	2.14	0.53
1:A:179:LYS:HD2	1:A:182:GLN:OE1	2.08	0.52
1:A:245:THR:HB	1:A:246:PRO:HD2	1.92	0.52
1:A:411:LEU:CD1	1:B:113:LEU:HD22	2.38	0.52
1:A:451:VAL:HG13	1:A:452:GLN:N	2.25	0.52
1:A:454:ILE:HA	1:A:457:MET:HE2	1.91	0.52
1:B:200:VAL:O	1:B:204:ILE:HG13	2.09	0.52

*Continued on next page...*

*Continued from previous page...*

Atom-1	Atom-2	Interatomic distance (Å)	Clash overlap (Å)
1:A:454:ILE:HA	1:A:457:MET:CE	2.40	0.52
1:A:192:ASN:ND2	1:A:325:GLN:HE21	2.08	0.52
1:A:27:GLY:O	1:A:31:LEU:HD13	2.10	0.52
1:A:294:THR:HG23	1:A:295:GLY:N	2.25	0.52
1:A:293:ASN:ND2	1:B:111:LEU:HD13	2.25	0.52
1:B:101:VAL:CG1	1:B:102:PRO:HD2	2.36	0.52
1:B:171:LEU:HD22	1:B:174:LEU:HD12	1.92	0.51
1:B:264:VAL:HG23	1:B:267:LEU:HB2	1.90	0.51
1:A:290:SER:O	1:A:291:ASP:C	2.48	0.51
1:A:333:LEU:HD11	1:A:337:ILE:HD12	1.92	0.51
1:A:12:GLU:CG	1:A:181:LEU:HD13	2.36	0.51
1:A:208:ILE:HD13	1:A:337:ILE:HD11	1.91	0.51
1:B:154:ARG:NH2	1:B:190:LYS:HE2	2.25	0.51
1:A:17:VAL:HG11	1:A:187:MET:HE2	1.92	0.51
1:A:315:LYS:HG3	5:A:2050:HOH:O	2.11	0.51
1:A:145:ALA:N	1:A:146:PRO:CD	2.72	0.51
1:B:33:LEU:O	1:B:33:LEU:HD22	2.10	0.51
1:B:484:LYS:HA	5:B:2047:HOH:O	2.11	0.50
1:B:549:LEU:O	1:B:549:LEU:HD12	2.12	0.50
1:A:35:ASP:OD2	1:B:481:HIS:HE1	1.94	0.50
1:B:36:LYS:HD2	1:B:36:LYS:N	2.27	0.50
1:A:139:ILE:HD12	1:A:167:LEU:CD1	2.41	0.50
1:A:198:LYS:HD3	1:A:198:LYS:C	2.32	0.50
1:A:205:LEU:N	1:A:205:LEU:HD22	2.26	0.50
1:A:269:LYS:HB2	1:A:272:VAL:CG2	2.35	0.50
1:A:305:ASN:OD1	1:A:317:ARG:HD2	2.12	0.50
1:B:247:MET:HG2	1:B:410:VAL:HB	1.92	0.50
1:B:368:GLU:OE2	1:B:547:GLN:HB3	2.12	0.50
1:A:316:ILE:HD12	1:A:321:PHE:CE1	2.47	0.50
1:A:345:LYS:HD2	5:A:2032:HOH:O	2.11	0.50
1:A:374:LEU:O	1:A:376:ASN:N	2.45	0.50
1:B:4:ILE:HD11	1:B:8:LYS:HD3	1.94	0.50
1:B:27:GLY:N	1:B:30:ASN:HD21	2.09	0.50
1:A:76:VAL:HG23	1:A:77:GLY:H	1.77	0.49
1:A:101:VAL:HG13	1:A:102:PRO:HD2	1.93	0.49
1:A:154:ARG:NH1	1:A:158:VAL:HG21	2.28	0.49
1:B:201:ILE:HG23	1:B:205:LEU:CD2	2.42	0.49
1:A:219:ASP:HB3	1:A:286:GLY:O	2.11	0.49
1:A:365:LEU:HD13	1:A:512:VAL:HG12	1.93	0.49
1:B:338:ALA:HA	5:B:2032:HOH:O	2.11	0.49
1:A:439:ILE:HD12	1:A:439:ILE:N	2.28	0.49

*Continued on next page...*

*Continued from previous page...*

Atom-1	Atom-2	Interatomic distance (Å)	Clash overlap (Å)
1:B:78:GLU:O	1:B:82:LEU:HD13	2.13	0.49
1:B:224:ARG:HD2	1:B:405:TYR:HH	1.74	0.49
1:B:262:VAL:HG12	1:B:264:VAL:HG13	1.94	0.49
1:B:273:LYS:O	1:B:277:GLU:HG3	2.13	0.49
1:B:324:VAL:HG12	1:B:329:VAL:HG21	1.94	0.49
1:A:427:PHE:CD1	1:A:462:LEU:HD11	2.48	0.49
1:A:13:ARG:HG3	1:A:185:ILE:HD11	1.95	0.49
1:A:454:ILE:O	1:A:457:MET:HB2	2.13	0.49
1:A:476:ILE:HD13	1:A:476:ILE:O	2.13	0.49
1:A:139:ILE:HA	5:A:2023:HOH:O	2.12	0.49
1:A:201:ILE:HG22	1:A:202:ASP:N	2.28	0.49
1:B:225:HIS:HD2	1:B:311:SER:HB3	1.78	0.48
1:A:358:ALA:N	5:A:2059:HOH:O	2.41	0.48
1:B:356:ASN:HD22	1:B:373:GLN:HE21	1.59	0.48
1:A:324:VAL:CG1	1:A:329:VAL:HG21	2.41	0.48
1:A:497:SER:O	1:A:500:PRO:HG2	2.12	0.48
1:B:254:GLU:HG2	1:B:259:TYR:CZ	2.49	0.48
1:A:380:GLU:HG2	1:A:402:ASN:O	2.13	0.48
1:B:214:PRO:O	1:B:241:PRO:HD2	2.14	0.48
1:B:389:GLY:HA2	1:B:476:ILE:HG13	1.96	0.48
1:A:92:HIS:O	1:A:224:ARG:NH2	2.46	0.48
1:B:99:VAL:HG11	1:B:164:TYR:OH	2.13	0.48
1:B:37:ILE:HD11	1:B:44:ARG:C	2.34	0.48
1:B:227:VAL:HG11	1:B:326:MET:HE3	1.93	0.48
1:A:294:THR:CG2	1:A:295:GLY:N	2.77	0.48
1:B:246:PRO:HD3	1:B:264:VAL:HG12	1.94	0.48
1:B:426:ALA:HA	1:B:438:VAL:HG21	1.96	0.48
1:A:200:VAL:O	1:A:204:ILE:HG13	2.15	0.47
1:A:471:ASN:N	1:A:471:ASN:OD1	2.46	0.47
1:B:273:LYS:HE2	1:B:277:GLU:OE1	2.14	0.47
1:A:13:ARG:HD3	1:A:181:LEU:CD2	2.44	0.47
1:A:375:GLY:HA3	5:A:2060:HOH:O	2.13	0.47
1:A:486:GLN:HB3	1:B:38:TYR:OH	2.14	0.47
1:B:222:CYS:O	1:B:228:LYS:HE3	2.14	0.47
1:B:109:LYS:HB2	1:B:109:LYS:HZ3	1.76	0.47
1:B:203:THR:O	1:B:207:LEU:HD13	2.14	0.47
1:A:158:VAL:HG13	1:A:189:LEU:CD2	2.45	0.47
1:A:309:PHE:CE1	1:A:330:LEU:HD13	2.50	0.47
1:A:384:VAL:O	1:A:406:GLY:HA2	2.14	0.47
1:B:390:THR:HG23	2:B:600:TPP:O2B	2.14	0.47
1:B:316:ILE:HG22	1:B:317:ARG:HD3	1.96	0.47

*Continued on next page...*

*Continued from previous page...*

Atom-1	Atom-2	Interatomic distance (Å)	Clash overlap (Å)
1:B:423:LEU:HD23	1:B:457:MET:HG3	1.97	0.47
1:B:71:ILE:HA	1:B:98:VAL:O	2.15	0.47
1:B:471:ASN:OD1	1:B:471:ASN:N	2.47	0.47
1:B:20:ASN:ND2	1:B:65:LYS:HZ1	2.13	0.47
1:A:27:GLY:HA3	1:A:73:THR:HB	1.97	0.46
1:A:427:PHE:O	1:A:431:GLU:HG3	2.15	0.46
1:A:36:LYS:CD	1:A:36:LYS:H	2.28	0.46
1:A:443:GLY:HA3	5:A:2077:HOH:O	2.15	0.46
1:B:345:LYS:O	1:B:345:LYS:HD3	2.15	0.46
1:A:117:LEU:HG	1:B:89:TYR:CD2	2.50	0.46
1:A:201:ILE:HG23	1:A:205:LEU:CD2	2.46	0.46
1:B:534:ARG:HG3	1:B:534:ARG:HH11	1.80	0.46
1:A:28:ASP:OD2	1:A:115:HIS:HE1	1.99	0.46
1:A:360:PRO:HG2	1:A:363:THR:HG23	1.94	0.46
1:B:344:TYR:OH	1:B:347:VAL:HG23	2.16	0.46
1:A:115:HIS:HD2	1:B:412:TRP:O	1.99	0.46
1:B:238:THR:HB	1:B:240:PHE:CE2	2.50	0.46
1:A:5:THR:HA	1:A:174:LEU:O	2.16	0.46
1:B:124:VAL:HG13	1:B:125:PHE:N	2.30	0.46
1:B:205:LEU:H	1:B:205:LEU:HD22	1.81	0.46
1:A:462:LEU:O	1:A:533:ILE:CG1	2.60	0.46
1:A:114:HIS:O	1:A:115:HIS:CB	2.64	0.46
1:A:29:PHE:CE1	1:A:102:PRO:HB3	2.51	0.46
1:A:454:ILE:HG12	1:A:457:MET:HE3	1.98	0.46
1:A:463:LYS:HD3	1:A:531:SER:O	2.16	0.45
1:B:498:LEU:HD12	1:B:498:LEU:HA	1.84	0.45
1:A:154:ARG:NH1	1:A:186:ASP:O	2.48	0.45
1:A:355:ALA:O	1:A:356:ASN:O	2.34	0.45
1:A:201:ILE:O	1:A:202:ASP:C	2.54	0.45
1:A:408:SER:O	1:A:410:VAL:N	2.45	0.45
1:A:413:GLY:O	1:B:115:HIS:HE1	2.00	0.45
1:A:325:GLN:HE21	1:A:325:GLN:HB2	1.64	0.45
1:A:192:ASN:HD21	1:A:325:GLN:HB2	1.82	0.45
1:A:197:GLU:O	1:A:200:VAL:HB	2.16	0.45
1:A:443:GLY:CA	5:A:2077:HOH:O	2.64	0.45
1:B:112:LEU:HD23	1:B:122:PHE:CD1	2.51	0.45
1:B:315:LYS:HE2	1:B:317:ARG:O	2.15	0.45
1:A:453:GLU:OE1	1:A:453:GLU:HA	2.17	0.45
1:A:344:TYR:O	1:A:346:PRO:HD3	2.17	0.45
1:A:116:THR:HG21	1:A:122:PHE:CE1	2.37	0.44
1:B:51:GLU:HB2	1:B:80:SER:HB2	1.99	0.44

*Continued on next page...*



*Continued from previous page...*

Atom-1	Atom-2	Interatomic distance (Å)	Clash overlap (Å)
1:B:205:LEU:HD22	1:B:205:LEU:N	2.32	0.44
1:B:476:ILE:HG12	1:B:549:LEU:HD21	1.99	0.44
1:A:533:ILE:HD12	1:A:533:ILE:N	2.09	0.44
1:A:475:THR:CG2	1:A:542:VAL:O	2.66	0.44
1:A:243:PHE:CE2	1:A:260:GLY:HA3	2.53	0.44
1:A:412:TRP:NE1	1:B:76:VAL:HG12	2.32	0.44
1:B:11:PHE:HE2	1:B:33:LEU:HD22	1.82	0.44
1:B:104:ILE:HG22	1:B:170:ASN:OD1	2.18	0.44
1:A:238:THR:HB	1:A:240:PHE:CE1	2.53	0.44
1:B:7:GLY:C	1:B:36:LYS:HG2	2.37	0.44
1:B:41:GLU:N	1:B:41:GLU:OE1	2.51	0.44
1:B:556:THR:HG22	1:B:556:THR:O	2.18	0.44
1:A:136:THR:CG2	1:A:164:TYR:HB3	2.40	0.44
1:A:547:GLN:O	1:A:550:VAL:HG12	2.18	0.44
1:B:9:TYR:CD2	1:B:181:LEU:HD21	2.53	0.44
1:A:314:MET:HB2	1:A:321:PHE:HB2	2.00	0.43
1:B:169:ALA:O	1:B:172:VAL:HG22	2.17	0.43
1:A:256:HIS:HE1	1:A:258:ARG:HG2	1.83	0.43
1:B:476:ILE:HB	2:B:600:TPP:O2B	2.18	0.43
1:A:15:LYS:HE2	1:A:41:GLU:O	2.18	0.43
1:A:37:ILE:CG2	1:A:38:TYR:N	2.81	0.43
1:B:269:LYS:HB2	1:B:272:VAL:HG23	1.99	0.43
1:B:269:LYS:HE2	1:B:353:THR:OG1	2.19	0.43
1:B:14:LEU:O	1:B:17:VAL:HG22	2.18	0.43
1:B:392:ALA:O	1:B:395:ILE:HG22	2.19	0.43
1:A:499:LEU:HD13	1:A:507:TYR:HB2	2.00	0.43
1:B:219:ASP:O	1:B:222:CYS:SG	2.71	0.43
1:A:357:ALA:O	1:A:358:ALA:C	2.57	0.43
1:B:223:SER:HA	1:B:228:LYS:NZ	2.34	0.43
1:A:211:ALA:CB	1:A:214:PRO:HG3	2.49	0.43
1:A:309:PHE:CD1	1:A:330:LEU:HD13	2.54	0.43
1:A:536:ILE:N	1:A:536:ILE:HD12	2.34	0.43
1:B:307:VAL:HG13	1:B:316:ILE:HG12	2.00	0.43
1:A:11:PHE:CE1	1:A:22:VAL:HG21	2.52	0.43
1:A:213:ASN:N	1:A:214:PRO:HD3	2.33	0.43
1:B:13:ARG:HG3	1:B:185:ILE:CD1	2.41	0.43
1:B:11:PHE:CE1	1:B:37:ILE:HB	2.54	0.42
1:B:145:ALA:N	1:B:146:PRO:CD	2.82	0.42
1:B:253:ASP:OD1	1:B:402:ASN:ND2	2.51	0.42
1:A:14:LEU:HD12	1:A:14:LEU:HA	1.88	0.42
1:A:95:VAL:O	1:A:162:PRO:HA	2.20	0.42

*Continued on next page...*

*Continued from previous page...*

Atom-1	Atom-2	Interatomic distance (Å)	Clash overlap (Å)
1:A:481:HIS:HE1	1:B:35:ASP:OD2	2.01	0.42
1:A:415:ILE:HG13	1:A:415:ILE:O	2.19	0.42
1:B:113:LEU:O	1:B:116:THR:HG23	2.19	0.42
1:B:115:HIS:NE2	4:B:602:PYM:H32	2.35	0.42
1:A:496:LEU:C	1:A:498:LEU:H	2.22	0.42
1:B:101:VAL:CG1	1:B:102:PRO:CD	2.96	0.42
1:B:260:GLY:HA2	1:B:349:VAL:HG13	2.02	0.42
1:B:282:ILE:O	1:B:306:ILE:HG23	2.20	0.42
1:B:500:PRO:HD3	1:B:507:TYR:CE2	2.54	0.42
1:A:55:ALA:HB2	1:A:81:ALA:HB1	2.01	0.42
1:A:506:ASP:OD1	1:A:532:LYS:HD3	2.19	0.42
1:B:309:PHE:CD2	1:B:330:LEU:HD13	2.55	0.42
1:B:448:GLN:NE2	1:B:493:TRP:CE2	2.87	0.42
1:A:15:LYS:HZ3	1:A:42:GLY:C	2.23	0.42
1:A:101:VAL:O	1:A:168:PRO:HA	2.20	0.42
1:A:223:SER:HA	1:A:228:LYS:HE3	2.01	0.42
1:B:427:PHE:HD1	1:B:427:PHE:HA	1.78	0.42
1:A:192:ASN:ND2	1:A:325:GLN:NE2	2.68	0.42
1:A:293:ASN:HD21	1:B:111:LEU:HD13	1.84	0.42
1:B:252:ILE:HD13	1:B:252:ILE:HA	1.82	0.42
1:A:79:LEU:HD23	1:A:82:LEU:CD2	2.50	0.41
1:B:439:ILE:N	1:B:439:ILE:HD12	2.35	0.41
1:A:395:ILE:O	1:A:395:ILE:HG13	2.20	0.41
1:A:476:ILE:HB	2:A:600:TPP:O2B	2.20	0.41
1:B:227:VAL:HG22	1:B:230:GLU:HB2	2.01	0.41
1:A:241:PRO:HB3	1:A:349:VAL:HG23	2.01	0.41
1:B:306:ILE:HG22	1:B:307:VAL:N	2.33	0.41
1:B:519:ASP:O	1:B:523:GLN:HB2	2.20	0.41
1:A:333:LEU:CD1	1:A:337:ILE:HD12	2.50	0.41
1:A:353:THR:HA	1:A:354:PRO:HD3	1.92	0.41
1:A:124:VAL:HG13	1:A:125:PHE:N	2.35	0.41
1:A:205:LEU:N	1:A:205:LEU:CD2	2.84	0.41
1:B:29:PHE:CD1	1:B:29:PHE:N	2.88	0.41
1:A:192:ASN:HD21	1:A:325:GLN:NE2	2.17	0.41
1:A:211:ALA:HB1	1:A:214:PRO:HG3	2.03	0.41
1:A:419:THR:HB	1:A:450:THR:OG1	2.21	0.41
1:B:17:VAL:HG23	1:B:19:VAL:HG23	2.03	0.41
1:B:52:LEU:HD22	1:B:56:TYR:CE2	2.55	0.41
1:B:309:PHE:HB3	1:B:326:MET:HB2	2.01	0.41
1:B:310:HIS:H	1:B:314:MET:HE1	1.84	0.41
1:A:138:MET:SD	1:A:166:GLY:HA3	2.61	0.41

*Continued on next page...*

Continued from previous page...

Atom-1	Atom-2	Interatomic distance (Å)	Clash overlap (Å)
1:A:256:HIS:HA	1:A:257:PRO:HD3	1.88	0.41
1:A:269:LYS:O	1:A:270:PRO:C	2.57	0.41
1:A:294:THR:HG22	1:A:296:SER:N	2.19	0.41
1:A:324:VAL:HG12	1:A:329:VAL:CG2	2.42	0.41
1:A:487:TYR:O	1:B:26:PRO:HG3	2.21	0.41
1:B:264:VAL:HG23	1:B:267:LEU:C	2.42	0.41
1:B:282:ILE:HB	1:B:306:ILE:HG23	2.03	0.41
1:B:435:LYS:HA	1:B:435:LYS:HD3	1.74	0.41
1:A:45:TRP:O	1:A:46:ALA:C	2.59	0.40
1:A:476:ILE:CG2	1:A:477:GLU:N	2.84	0.40
1:B:263:TYR:HD1	1:B:268:SER:HG	1.69	0.40
1:B:310:HIS:O	1:B:326:MET:HB3	2.21	0.40
1:B:534:ARG:HG3	1:B:534:ARG:NH1	2.37	0.40
1:A:87:GLY:HA3	5:A:2014:HOH:O	2.22	0.40
1:A:101:VAL:CG1	1:A:102:PRO:HD2	2.51	0.40
1:A:134:GLU:HB2	1:A:161:ARG:HB2	2.02	0.40
1:A:515:THR:CG2	1:A:516:GLY:N	2.84	0.40
1:B:447:LEU:O	1:B:451:VAL:HB	2.22	0.40
1:A:4:ILE:HG13	1:A:8:LYS:HD3	2.04	0.40
1:A:56:TYR:O	1:A:59:ASP:HB3	2.22	0.40
1:A:482:GLY:N	1:A:483:PRO:HD3	2.36	0.40
1:B:344:TYR:O	1:B:346:PRO:HD3	2.21	0.40
1:A:254:GLU:HG3	1:A:400:PHE:HB2	2.02	0.40
1:B:227:VAL:O	1:B:227:VAL:HG13	2.22	0.40

There are no symmetry-related clashes.

## 5.3 Torsion angles [i](#)

### 5.3.1 Protein backbone [i](#)

In the following table, the Percentiles column shows the percent Ramachandran outliers of the chain as a percentile score with respect to all X-ray entries followed by that with respect to entries of similar resolution.

The Analysed column shows the number of residues for which the backbone conformation was analysed, and the total number of residues.

Mol	Chain	Analysed	Favoured	Allowed	Outliers	Percentiles
1	A	553/563 (98%)	493 (89%)	46 (8%)	14 (2%)	<b>5</b> <b>6</b>

Continued on next page...

*Continued from previous page...*

Mol	Chain	Analysed	Favoured	Allowed	Outliers	Percentiles	
1	B	553/563 (98%)	489 (88%)	56 (10%)	8 (1%)	11	15
All	All	1106/1126 (98%)	982 (89%)	102 (9%)	22 (2%)	7	9

All (22) Ramachandran outliers are listed below:

Mol	Chain	Res	Type
1	A	356	ASN
1	B	358	ALA
1	A	75	GLY
1	A	103	SER
1	A	346	PRO
1	A	375	GLY
1	B	288	LEU
1	B	296	SER
1	B	299	TYR
1	B	301	TYR
1	A	114	HIS
1	A	358	ALA
1	B	220	ALA
1	A	74	PHE
1	A	115	HIS
1	A	291	ASP
1	A	194	ALA
1	A	229	ALA
1	A	317	ARG
1	B	327	LYS
1	A	361	ALA
1	B	497	SER

### 5.3.2 Protein sidechains [i](#)

In the following table, the Percentiles column shows the percent sidechain outliers of the chain as a percentile score with respect to all X-ray entries followed by that with respect to entries of similar resolution.

The Analysed column shows the number of residues for which the sidechain conformation was analysed, and the total number of residues.

Mol	Chain	Analysed	Rotameric	Outliers	Percentiles	
1	A	462/467 (99%)	434 (94%)	28 (6%)	18	30
1	B	462/467 (99%)	424 (92%)	38 (8%)	11	17

*Continued on next page...*

*Continued from previous page...*

Mol	Chain	Analysed	Rotameric	Outliers	Percentiles	
All	All	924/934 (99%)	858 (93%)	66 (7%)	14	23

All (66) residues with a non-rotameric sidechain are listed below:

Mol	Chain	Res	Type
1	A	14	LEU
1	A	31	LEU
1	A	33	LEU
1	A	34	LEU
1	A	52	LEU
1	A	82	LEU
1	A	126	HIS
1	A	224	ARG
1	A	227	VAL
1	A	232	LYS
1	A	271	GLU
1	A	274	GLU
1	A	294	THR
1	A	317	ARG
1	A	330	LEU
1	A	339	ASP
1	A	345	LYS
1	A	349	VAL
1	A	365	LEU
1	A	373	GLN
1	A	427	PHE
1	A	440	LEU
1	A	447	LEU
1	A	476	ILE
1	A	479	LEU
1	A	533	ILE
1	A	551	GLU
1	A	555	LEU
1	B	13	ARG
1	B	14	LEU
1	B	18	ASN
1	B	30	ASN
1	B	33	LEU
1	B	37	ILE
1	B	52	LEU
1	B	70	ILE
1	B	99	VAL

*Continued on next page...*

*Continued from previous page...*

<b>Mol</b>	<b>Chain</b>	<b>Res</b>	<b>Type</b>
1	B	109	LYS
1	B	110	GLN
1	B	113	LEU
1	B	188	SER
1	B	224	ARG
1	B	232	LYS
1	B	271	GLU
1	B	274	GLU
1	B	297	PHE
1	B	317	ARG
1	B	330	LEU
1	B	337	ILE
1	B	339	ASP
1	B	345	LYS
1	B	365	LEU
1	B	427	PHE
1	B	440	LEU
1	B	447	LEU
1	B	452	GLN
1	B	456	THR
1	B	471	ASN
1	B	476	ILE
1	B	479	LEU
1	B	487	TYR
1	B	498	LEU
1	B	515	THR
1	B	533	ILE
1	B	547	GLN
1	B	552	GLN

Sometimes sidechains can be flipped to improve hydrogen bonding and reduce clashes. All (32) such sidechains are listed below:

<b>Mol</b>	<b>Chain</b>	<b>Res</b>	<b>Type</b>
1	A	83	ASN
1	A	115	HIS
1	A	192	ASN
1	A	293	ASN
1	A	325	GLN
1	A	331	GLN
1	A	356	ASN
1	A	373	GLN
1	A	379	GLN

*Continued on next page...*

*Continued from previous page...*

Mol	Chain	Res	Type
1	A	402	ASN
1	A	481	HIS
1	A	486	GLN
1	A	548	ASN
1	B	18	ASN
1	B	20	ASN
1	B	30	ASN
1	B	83	ASN
1	B	114	HIS
1	B	126	HIS
1	B	131	ASN
1	B	182	GLN
1	B	192	ASN
1	B	305	ASN
1	B	325	GLN
1	B	331	GLN
1	B	372	ASN
1	B	373	GLN
1	B	379	GLN
1	B	481	HIS
1	B	486	GLN
1	B	547	GLN
1	B	552	GLN

### 5.3.3 RNA [i](#)

There are no RNA molecules in this entry.

### 5.4 Non-standard residues in protein, DNA, RNA chains [i](#)

There are no non-standard protein/DNA/RNA residues in this entry.

### 5.5 Carbohydrates [i](#)

There are no monosaccharides in this entry.

### 5.6 Ligand geometry [i](#)

Of 6 ligands modelled in this entry, 2 are monoatomic - leaving 4 for Mogul analysis.

In the following table, the Counts columns list the number of bonds (or angles) for which Mogul statistics could be retrieved, the number of bonds (or angles) that are observed in the model and the number of bonds (or angles) that are defined in the Chemical Component Dictionary. The Link column lists molecule types, if any, to which the group is linked. The Z score for a bond length (or angle) is the number of standard deviations the observed value is removed from the expected value. A bond length (or angle) with  $|Z| > 2$  is considered an outlier worth inspection. RMSZ is the root-mean-square of all Z scores of the bond lengths (or angles).

Mol	Type	Chain	Res	Link	Bond lengths			Bond angles		
					Counts	RMSZ	# Z  > 2	Counts	RMSZ	# Z  > 2
2	TPP	B	600	3	22,27,27	3.09	8 (36%)	29,40,40	1.73	9 (31%)
4	PYM	B	602	-	4,5,5	4.20	2 (50%)	4,6,6	6.73	3 (75%)
4	PYM	A	602	-	4,5,5	3.97	2 (50%)	4,6,6	6.71	3 (75%)
2	TPP	A	600	3	22,27,27	2.07	9 (40%)	29,40,40	1.53	5 (17%)

In the following table, the Chirals column lists the number of chiral outliers, the number of chiral centers analysed, the number of these observed in the model and the number defined in the Chemical Component Dictionary. Similar counts are reported in the Torsion and Rings columns. '-' means no outliers of that kind were identified.

Mol	Type	Chain	Res	Link	Chirals	Torsions	Rings
2	TPP	B	600	3	-	2/16/17/17	0/2/2/2
4	PYM	B	602	-	-	0/1/4/4	-
4	PYM	A	602	-	-	0/1/4/4	-
2	TPP	A	600	3	-	1/16/17/17	0/2/2/2

All (21) bond length outliers are listed below:

Mol	Chain	Res	Type	Atoms	Z	Observed(Å)	Ideal(Å)
2	B	600	TPP	C6-C5	-11.98	1.45	1.50
4	B	602	PYM	C3-C2	-7.96	1.34	1.50
4	A	602	PYM	C3-C2	-7.59	1.35	1.50
2	A	600	TPP	C4-N3	-4.91	1.35	1.39
2	A	600	TPP	C6-C5	-4.18	1.49	1.50
2	B	600	TPP	C7'-N3	3.28	1.54	1.48
2	A	600	TPP	C5'-C4'	2.94	1.48	1.42
2	B	600	TPP	C4'-N3'	2.83	1.39	1.35
2	A	600	TPP	C7'-N3	2.81	1.53	1.48
2	B	600	TPP	C6'-N1'	2.77	1.40	1.34
2	A	600	TPP	C4'-N3'	2.66	1.38	1.35
2	B	600	TPP	C6-C7	2.55	1.59	1.50
2	A	600	TPP	C2-N3	-2.48	1.30	1.36
2	A	600	TPP	PB-O3B	-2.35	1.45	1.54

*Continued on next page...*



Continued from previous page...

Mol	Chain	Res	Type	Atoms	Z	Observed(Å)	Ideal(Å)
2	B	600	TPP	C2'-N3'	-2.24	1.30	1.34
2	B	600	TPP	C5'-C4'	2.23	1.46	1.42
2	B	600	TPP	CM4-C4	2.20	1.54	1.49
4	A	602	PYM	O1-C1	2.15	1.29	1.24
2	A	600	TPP	CM4-C4	2.07	1.54	1.49
2	A	600	TPP	C2'-N1'	2.05	1.37	1.34
4	B	602	PYM	O1-C1	2.03	1.29	1.24

All (20) bond angle outliers are listed below:

Mol	Chain	Res	Type	Atoms	Z	Observed(°)	Ideal(°)
4	B	602	PYM	C3-C2-C1	8.83	131.70	117.95
4	A	602	PYM	C3-C2-C1	8.22	130.74	117.95
4	B	602	PYM	O2-C2-C3	-7.93	102.16	119.73
4	A	602	PYM	O2-C2-C3	-7.89	102.25	119.73
4	A	602	PYM	O2-C2-C1	7.01	127.00	118.99
4	B	602	PYM	O2-C2-C1	6.27	126.14	118.99
2	B	600	TPP	O7-PA-O1A	-3.15	96.76	109.07
2	B	600	TPP	C6-C5-C4	2.98	129.83	127.43
2	B	600	TPP	N1'-C2'-N3'	-2.90	120.54	125.54
2	B	600	TPP	O2A-PA-O7	2.82	120.84	107.75
2	A	600	TPP	N1'-C2'-N3'	-2.81	120.70	125.54
2	A	600	TPP	C6'-N1'-C2'	2.80	120.73	115.96
2	B	600	TPP	C6'-N1'-C2'	2.66	120.50	115.96
2	A	600	TPP	PA-O3A-PB	2.61	141.78	132.83
2	A	600	TPP	C7'-N3-C2	-2.45	120.92	125.35
2	A	600	TPP	C5'-C7'-N3	2.39	117.25	113.28
2	B	600	TPP	C5'-C7'-N3	2.31	117.12	113.28
2	B	600	TPP	C7'-N3-C2	-2.17	121.43	125.35
2	B	600	TPP	CM2-C2'-N1'	2.17	119.52	117.14
2	B	600	TPP	N4'-C4'-N3'	-2.06	114.12	117.03

There are no chirality outliers.

All (3) torsion outliers are listed below:

Mol	Chain	Res	Type	Atoms
2	B	600	TPP	C4-C5-C6-C7
2	B	600	TPP	C5-C6-C7-O7
2	A	600	TPP	C4-C5-C6-C7

There are no ring outliers.

3 monomers are involved in 4 short contacts:

Mol	Chain	Res	Type	Clashes	Symm-Clashes
2	B	600	TPP	2	0
4	B	602	PYM	1	0
2	A	600	TPP	1	0

The following is a two-dimensional graphical depiction of Mogul quality analysis of bond lengths, bond angles, torsion angles, and ring geometry for all instances of the Ligand of Interest. In addition, ligands with molecular weight > 250 and outliers as shown on the validation Tables will also be included. For torsion angles, if less than 5% of the Mogul distribution of torsion angles is within 10 degrees of the torsion angle in question, then that torsion angle is considered an outlier. Any bond that is central to one or more torsion angles identified as an outlier by Mogul will be highlighted in the graph. For rings, the root-mean-square deviation (RMSD) between the ring in question and similar rings identified by Mogul is calculated over all ring torsion angles. If the average RMSD is greater than 60 degrees and the minimal RMSD between the ring in question and any Mogul-identified rings is also greater than 60 degrees, then that ring is considered an outlier. The outliers are highlighted in purple. The color gray indicates Mogul did not find sufficient equivalents in the CSD to analyse the geometry.

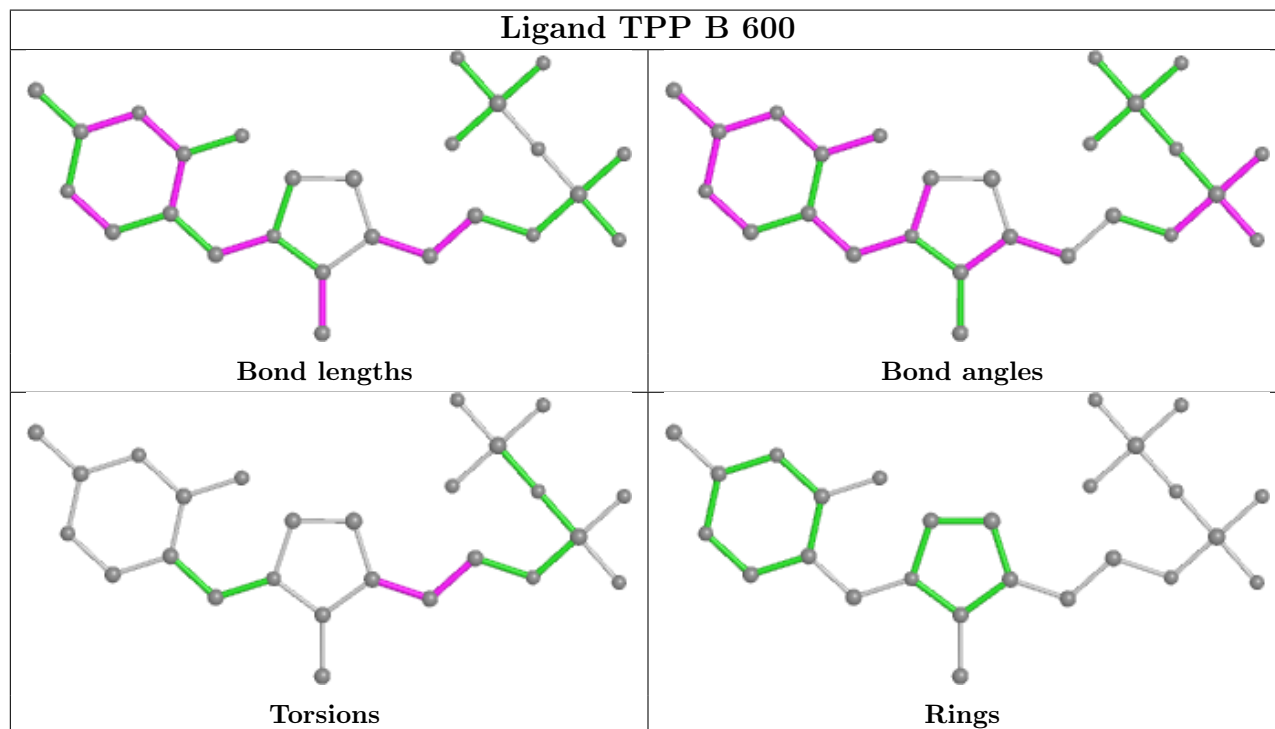

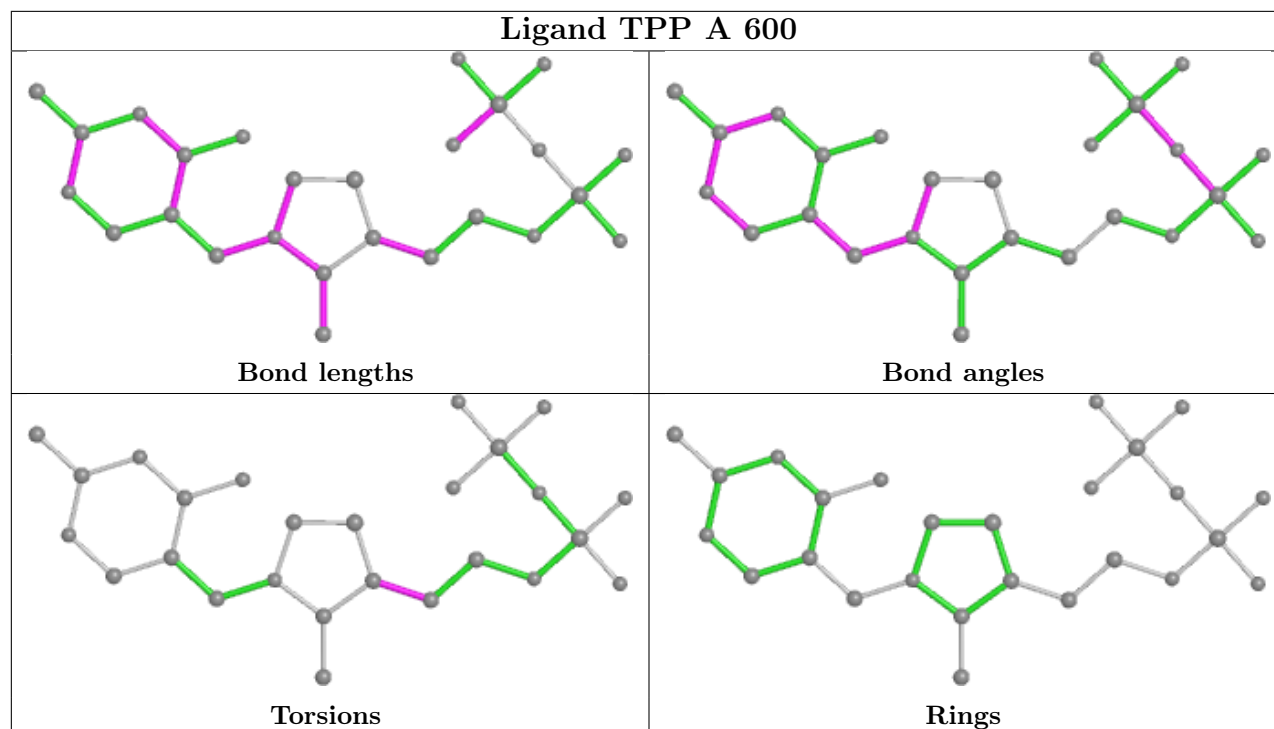

## 5.7 Other polymers [i](#)

There are no such residues in this entry.

## 5.8 Polymer linkage issues [i](#)

There are no chain breaks in this entry.

## 6 Fit of model and data [i](#)

### 6.1 Protein, DNA and RNA chains [i](#)

In the following table, the column labelled '#RSRZ > 2' contains the number (and percentage) of RSRZ outliers, followed by percent RSRZ outliers for the chain as percentile scores relative to all X-ray entries and entries of similar resolution. The OWAB column contains the minimum, median, 95<sup>th</sup> percentile and maximum values of the occupancy-weighted average B-factor per residue. The column labelled 'Q < 0.9' lists the number of (and percentage) of residues with an average occupancy less than 0.9.

Mol	Chain	Analysed	<RSRZ>	#RSRZ>2	OWAB(Å <sup>2</sup> )	Q<0.9
1	A	545/563 (96%)	-0.86	0 <b>100</b>   <b>100</b>	10, 31, 53, 68	0
1	B	540/563 (95%)	-0.77	3 (0%) <b>89</b>   <b>88</b>	10, 34, 64, 98	1 (0%)
All	All	1085/1126 (96%)	-0.81	3 (0%) <b>94</b>   <b>93</b>	10, 32, 60, 98	1 (0%)

All (3) RSRZ outliers are listed below:

Mol	Chain	Res	Type	RSRZ
1	B	555	LEU	3.7
1	B	552	GLN	2.8
1	B	548	ASN	2.1

### 6.2 Non-standard residues in protein, DNA, RNA chains [i](#)

There are no non-standard protein/DNA/RNA residues in this entry.

### 6.3 Carbohydrates [i](#)

There are no monosaccharides in this entry.

### 6.4 Ligands [i](#)

In the following table, the Atoms column lists the number of modelled atoms in the group and the number defined in the chemical component dictionary. The B-factors column lists the minimum, median, 95<sup>th</sup> percentile and maximum values of B factors of atoms in the group. The column labelled 'Q < 0.9' lists the number of atoms with occupancy less than 0.9.

Mol	Type	Chain	Res	Atoms	RSCC	RSR	B-factors(Å <sup>2</sup> )	Q<0.9
3	MG	B	601	1/1	0.74	0.20	71,71,71,71	0
3	MG	A	601	1/1	0.91	0.14	26,26,26,26	0

*Continued on next page...*

Continued from previous page...

Mol	Type	Chain	Res	Atoms	RSCC	RSR	B-factors( $\text{\AA}^2$ )	Q<0.9
4	PYM	A	602	6/6	0.92	0.18	50,52,54,54	0
4	PYM	B	602	6/6	0.95	0.11	44,46,46,46	0
2	TPP	A	600	26/26	0.98	0.08	18,24,27,28	0
2	TPP	B	600	26/26	0.99	0.08	11,18,22,23	0

The following is a graphical depiction of the model fit to experimental electron density of all instances of the Ligand of Interest. In addition, ligands with molecular weight > 250 and outliers as shown on the geometry validation Tables will also be included. Each fit is shown from different orientation to approximate a three-dimensional view.

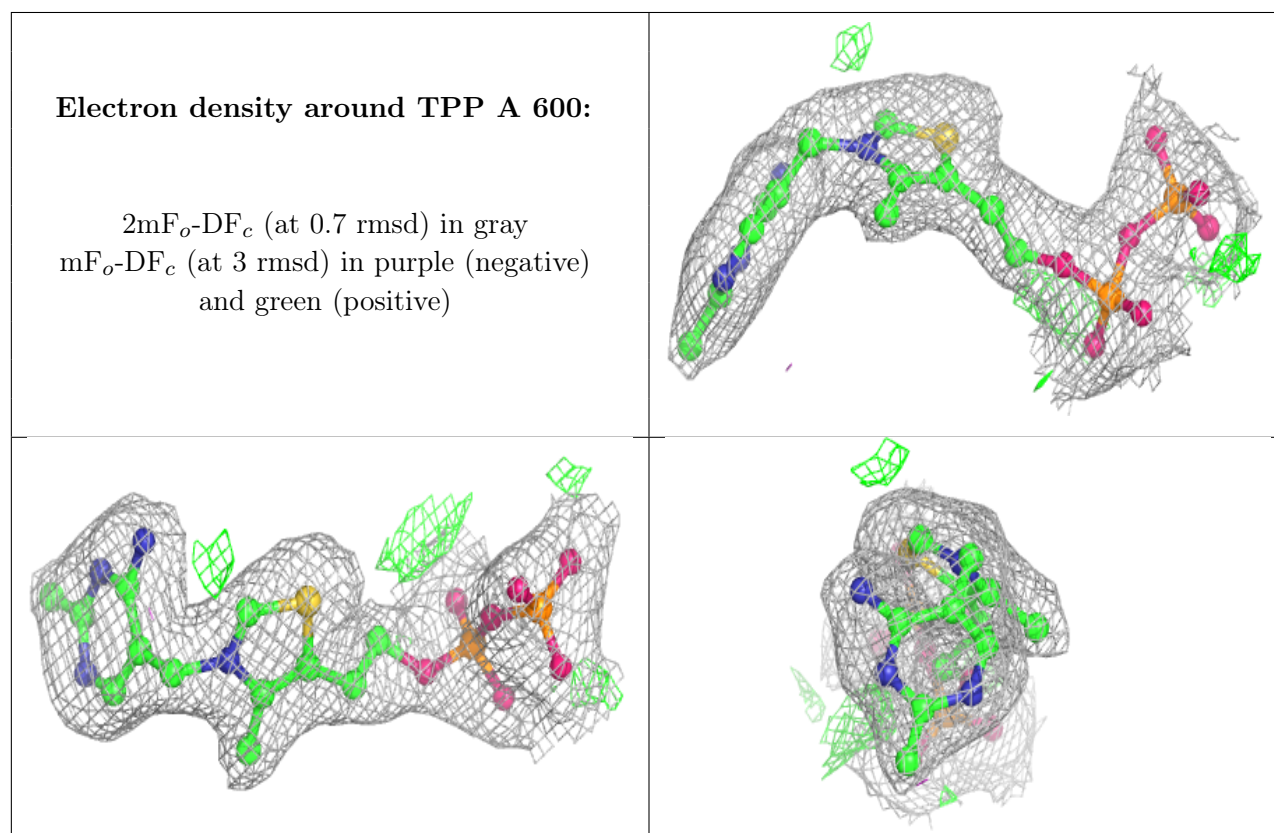

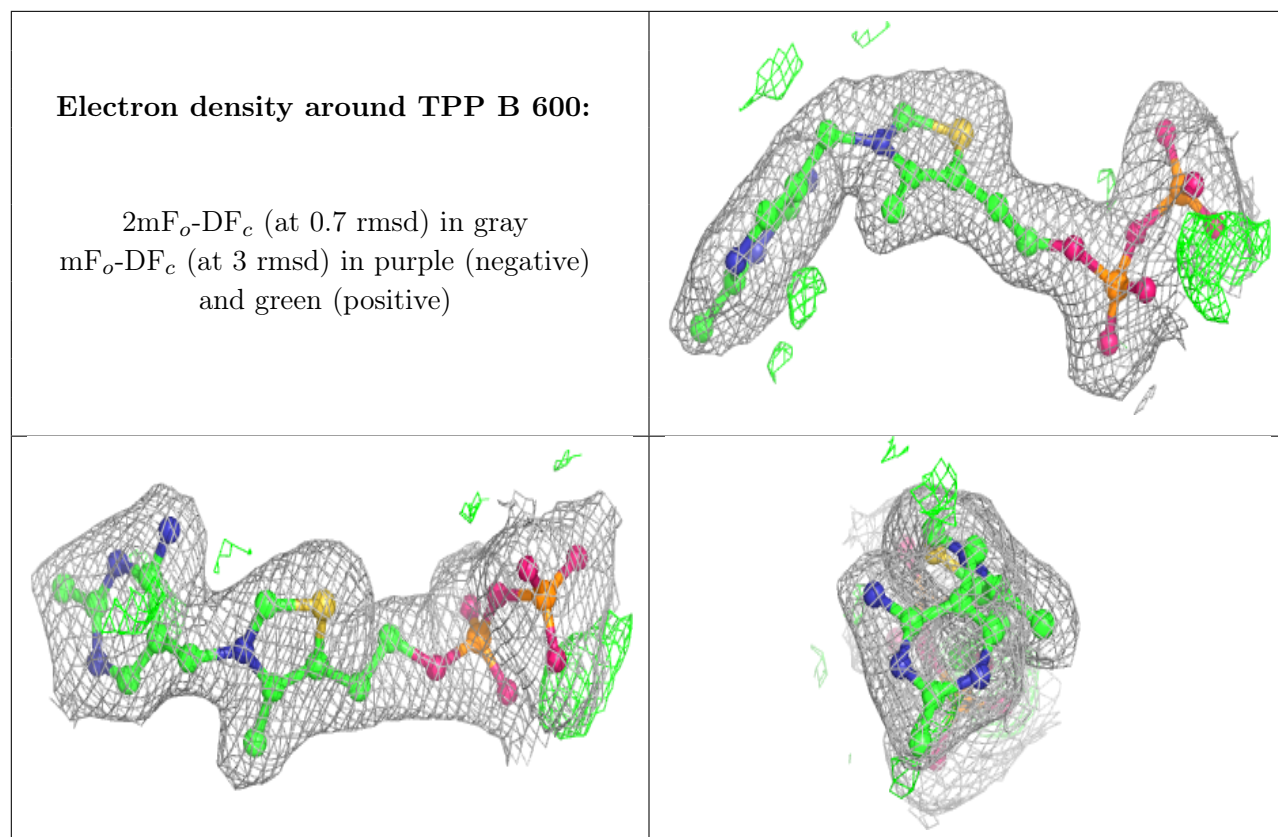

## 6.5 Other polymers [i](#)

There are no such residues in this entry.