



Full wwPDB X-ray Structure Validation Report ⓘ

Mar 20, 2024 – 06:49 PM JST

PDB ID : 8JJC
Title : Tubulin-Y62
Authors : Yang, J.
Deposited on : 2023-05-30
Resolution : 2.76 Å(reported)

This is a Full wwPDB X-ray Structure Validation Report for a publicly released PDB entry.

We welcome your comments at validation@mail.wwpdb.org

A user guide is available at

<https://www.wwpdb.org/validation/2017/XrayValidationReportHelp>

with specific help available everywhere you see the ⓘ symbol.

The types of validation reports are described at

<http://www.wwpdb.org/validation/2017/FAQs#types>.

The following versions of software and data (see [references ⓘ](#)) were used in the production of this report:

MolProbity : 4.02b-467
Mogul : 1.8.5 (274361), CSD as541be (2020)
Xtriage (Phenix) : 1.13
EDS : 2.36
buster-report : 1.1.7 (2018)
Percentile statistics : 20191225.v01 (using entries in the PDB archive December 25th 2019)
Refmac : 5.8.0158
CCP4 : 7.0.044 (Gargrove)
Ideal geometry (proteins) : Engh & Huber (2001)
Ideal geometry (DNA, RNA) : Parkinson et al. (1996)
Validation Pipeline (wwPDB-VP) : 2.36

1 Overall quality at a glance

The following experimental techniques were used to determine the structure:

X-RAY DIFFRACTION

The reported resolution of this entry is 2.76 Å.

Percentile scores (ranging between 0-100) for global validation metrics of the entry are shown in the following graphic. The table shows the number of entries on which the scores are based.

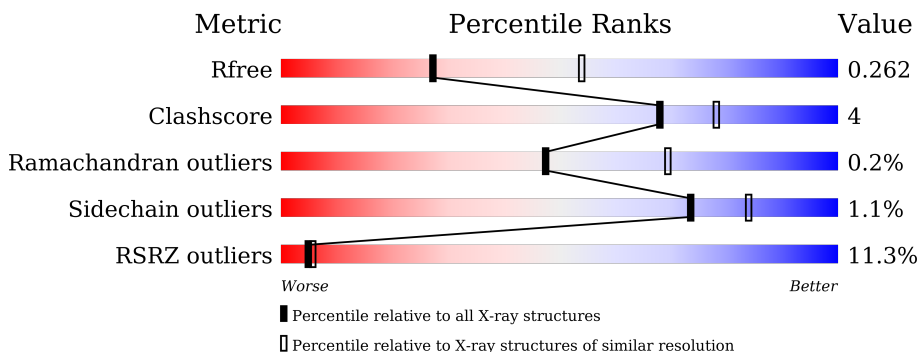

Metric	Whole archive (#Entries)	Similar resolution (#Entries, resolution range(Å))
R_{free}	130704	1235 (2.78-2.74)
Clashscore	141614	1277 (2.78-2.74)
Ramachandran outliers	138981	1257 (2.78-2.74)
Sidechain outliers	138945	1257 (2.78-2.74)
RSRZ outliers	127900	1207 (2.78-2.74)

The table below summarises the geometric issues observed across the polymeric chains and their fit to the electron density. The red, orange, yellow and green segments of the lower bar indicate the fraction of residues that contain outliers for ≥ 3 , 2, 1 and 0 types of geometric quality criteria respectively. A grey segment represents the fraction of residues that are not modelled. The numeric value for each fraction is indicated below the corresponding segment, with a dot representing fractions $\leq 5\%$. The upper red bar (where present) indicates the fraction of residues that have poor fit to the electron density. The numeric value is given above the bar.

Mol	Chain	Length	Quality of chain
1	A	451	 7% 89% 8%
1	C	451	 % 89% 8%
2	B	431	 7% 89% 10%
2	D	431	 15% 86% 12%
3	E	189	 6% 60% 5% 35%
4	F	380	 27% 81% 9% 8%

2 Entry composition [i](#)

There are 13 unique types of molecules in this entry. The entry contains 33734 atoms, of which 16410 are hydrogens and 0 are deuteriums.

In the tables below, the ZeroOcc column contains the number of atoms modelled with zero occupancy, the AltConf column contains the number of residues with at least one atom in alternate conformation and the Trace column contains the number of residues modelled with at most 2 atoms.

- Molecule 1 is a protein called Tubulin alpha-1B chain.

Mol	Chain	Residues	Atoms						ZeroOcc	AltConf	Trace
			Total	C	H	N	O	S			
1	A	438	Total	C	H	N	O	S	0	2	0
			6653	2146	3260	576	648	23			
1	C	440	Total	C	H	N	O	S	0	5	0
			6779	2183	3331	584	658	23			

- Molecule 2 is a protein called Tubulin beta chain.

Mol	Chain	Residues	Atoms						ZeroOcc	AltConf	Trace
			Total	C	H	N	O	S			
2	B	425	Total	C	H	N	O	S	0	1	0
			6414	2078	3111	562	638	25			
2	D	423	Total	C	H	N	O	S	0	0	0
			6361	2059	3090	556	632	24			

- Molecule 3 is a protein called Stathmin-4.

Mol	Chain	Residues	Atoms						ZeroOcc	AltConf	Trace
			Total	C	H	N	O	S			
3	E	123	Total	C	H	N	O	S	0	2	0
			1988	614	995	183	191	5			

- Molecule 4 is a protein called TTL.

Mol	Chain	Residues	Atoms						ZeroOcc	AltConf	Trace
			Total	C	H	N	O	S			
4	F	349	Total	C	H	N	O	S	0	0	0
			5225	1726	2533	462	490	14			

- Molecule 5 is GUANOSINE-5'-TRIPHOSPHATE (three-letter code: GTP) (formula: C₁₀H₁₆N₅O₁₄P₃).



Mol	Chain	Residues	Atoms					ZeroOcc	AltConf	
			Total	C	H	N	O			P
5	A	1	Total	C	H	N	O	P	42	0
			42	10	10	5	14	3		
5	C	1	Total	C	H	N	O	P	42	0
			42	10	10	5	14	3		
5	D	1	Total	C	H	N	O	P	42	0
			42	10	10	5	14	3		

- Molecule 6 is MAGNESIUM ION (three-letter code: MG) (formula: Mg).

Mol	Chain	Residues	Atoms		ZeroOcc	AltConf
			Total	Mg		
6	A	1	Total	Mg	1	0
			1	1		
6	B	1	Total	Mg	1	0
			1	1		
6	C	1	Total	Mg	1	0
			1	1		
6	D	1	Total	Mg	1	0
			1	1		
6	F	1	Total	Mg	1	0
			1	1		

- Molecule 7 is CALCIUM ION (three-letter code: CA) (formula: Ca).

Mol	Chain	Residues	Atoms		ZeroOcc	AltConf
			Total	Ca		
7	A	2	Total	Ca	2	0
			2	2		

Continued on next page...

Continued from previous page...

Mol	Chain	Residues	Atoms		ZeroOcc	AltConf
7	B	2	Total	Ca	2	0
			2	2		
7	C	1	Total	Ca	1	0
			1	1		
7	D	1	Total	Ca	1	0
			1	1		

- Molecule 8 is 2-(N-MORPHOLINO)-ETHANESULFONIC ACID (three-letter code: MES) (formula: C₆H₁₃NO₄S).

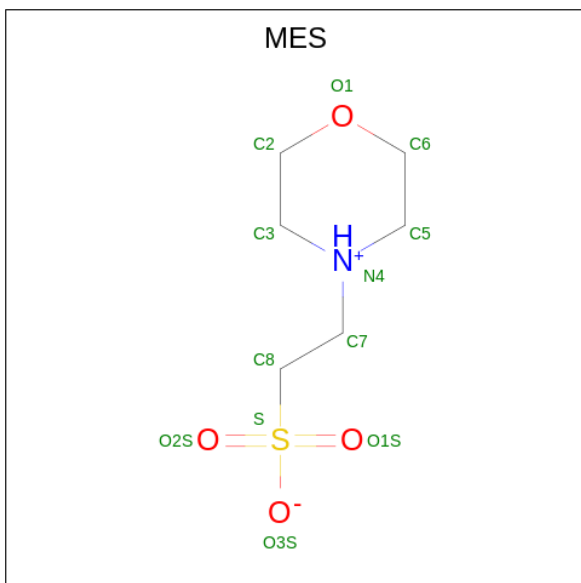

Mol	Chain	Residues	Atoms					ZeroOcc	AltConf	
			Total	C	H	N	O			S
8	B	1	24	6	12	1	4	1	24	0

- Molecule 9 is 4-(6,7-dimethoxy-3,4-dihydro-1 {H}-isoquinolin-2-yl)-6-(3-methoxyphenyl)pyrimidin-2-amine (three-letter code: UPO) (formula: C₂₂H₂₄N₄O₃) (labeled as "Ligand of Interest" by depositor).

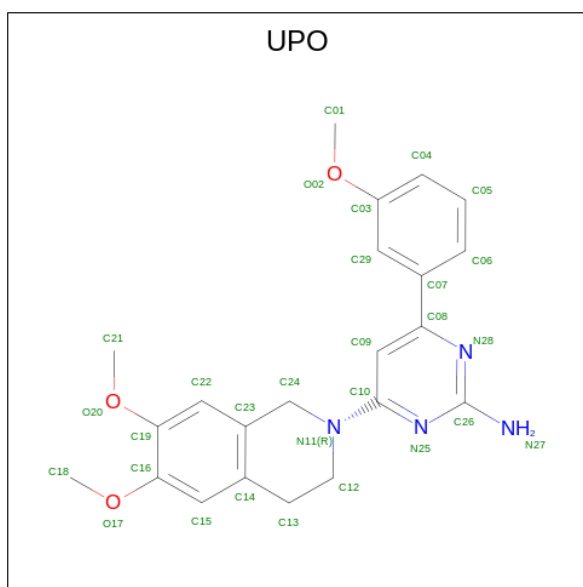

Mol	Chain	Residues	Atoms					ZeroOcc	AltConf
			Total	C	H	N	O		
9	B	1	53	22	24	4	3	0	0

- Molecule 10 is GUANOSINE-5'-DIPHOSPHATE (three-letter code: GDP) (formula: $C_{10}H_{15}N_5O_{11}P_2$).

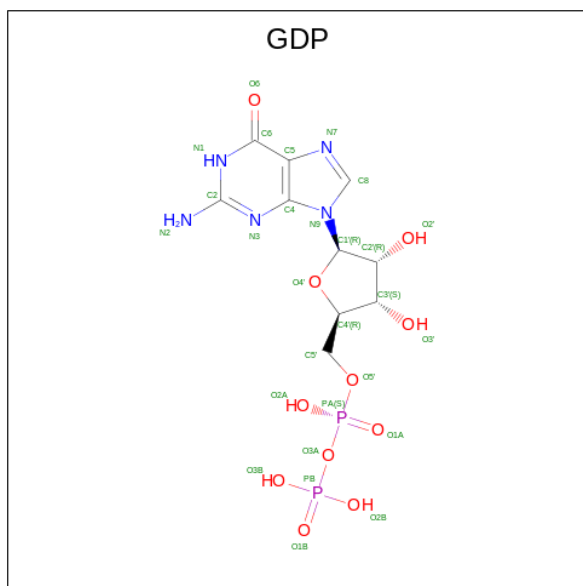

Mol	Chain	Residues	Atoms					ZeroOcc	AltConf	
			Total	C	H	N	O			P
10	B	1	38	10	10	5	11	2	38	0

- Molecule 11 is CHLORIDE ION (three-letter code: CL) (formula: Cl).

Mol	Chain	Residues	Atoms	ZeroOcc	AltConf
11	D	1	Total Cl 1 1	1	0

- Molecule 12 is PHOSPHOMETHYLPHOSPHONIC ACID ADENYLATE ESTER (three-letter code: ACP) (formula: C₁₁H₁₈N₅O₁₂P₃).

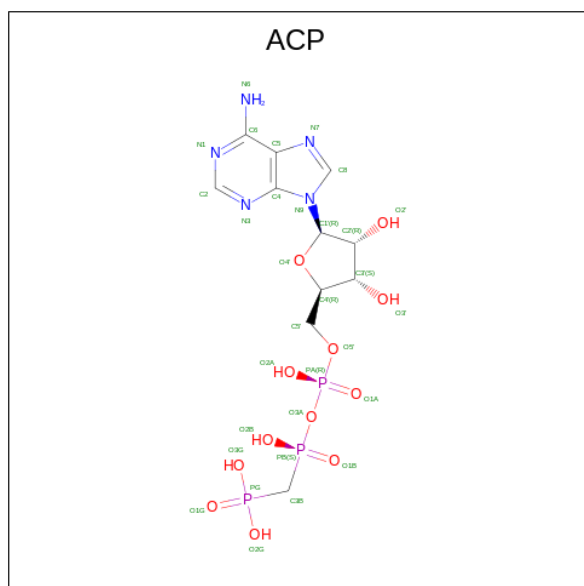

Mol	Chain	Residues	Atoms					ZeroOcc	AltConf	
			Total	C	H	N	O			P
12	F	1	Total 45	11	14	5	12	3	45	0

- Molecule 13 is water.

Mol	Chain	Residues	Atoms	ZeroOcc	AltConf
13	A	1	Total O 1 1	0	0
13	B	2	Total O 2 2	0	0
13	C	9	Total O 9 9	0	0
13	D	1	Total O 1 1	0	0
13	F	3	Total O 3 3	0	0

3 Residue-property plots [i](#)

These plots are drawn for all protein, RNA, DNA and oligosaccharide chains in the entry. The first graphic for a chain summarises the proportions of the various outlier classes displayed in the second graphic. The second graphic shows the sequence view annotated by issues in geometry and electron density. Residues are color-coded according to the number of geometric quality criteria for which they contain at least one outlier: green = 0, yellow = 1, orange = 2 and red = 3 or more. A red dot above a residue indicates a poor fit to the electron density ($RSRZ > 2$). Stretches of 2 or more consecutive residues without any outlier are shown as a green connector. Residues present in the sample, but not in the model, are shown in grey.

- Molecule 1: Tubulin alpha-1B chain

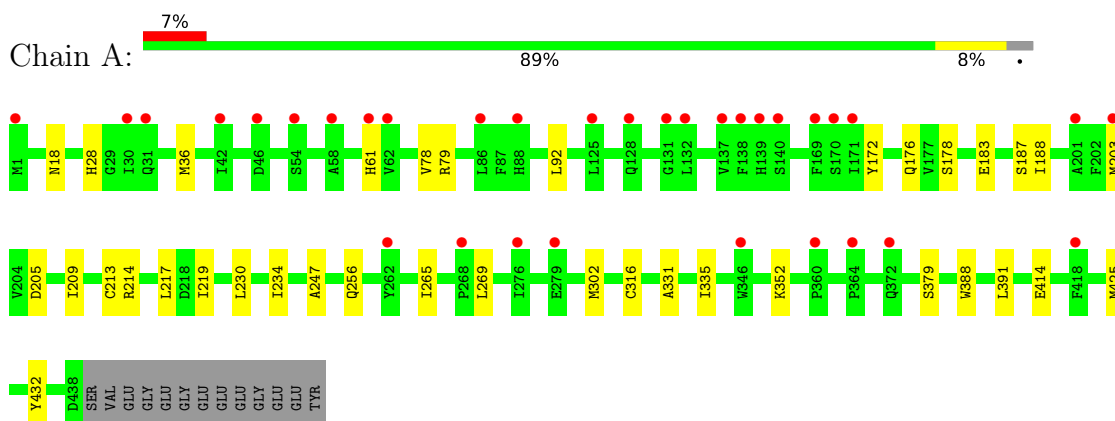

- Molecule 1: Tubulin alpha-1B chain

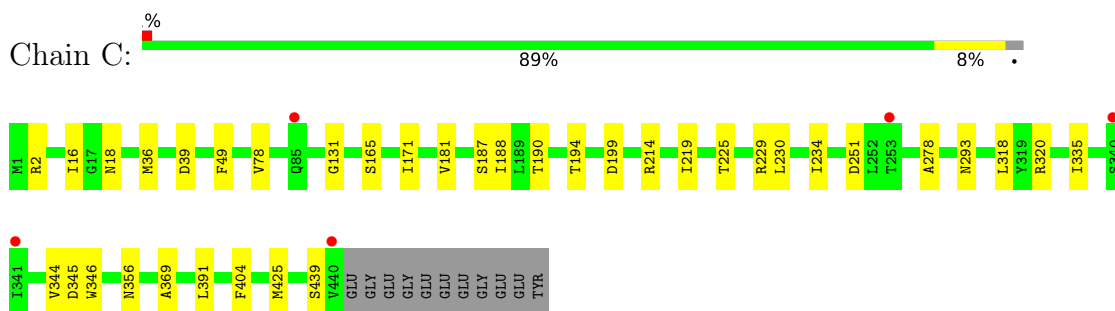

- Molecule 2: Tubulin beta chain

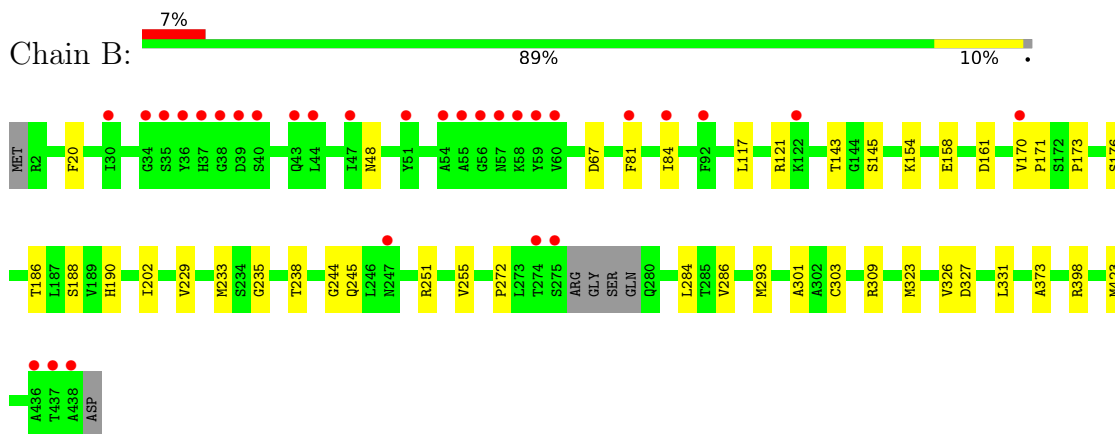

- Molecule 2: Tubulin beta chain

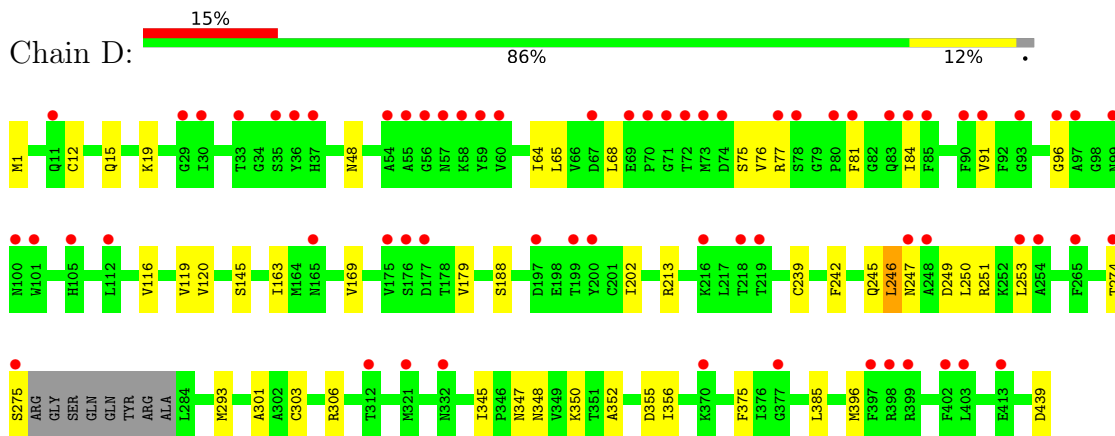

- Molecule 3: Stathmin-4

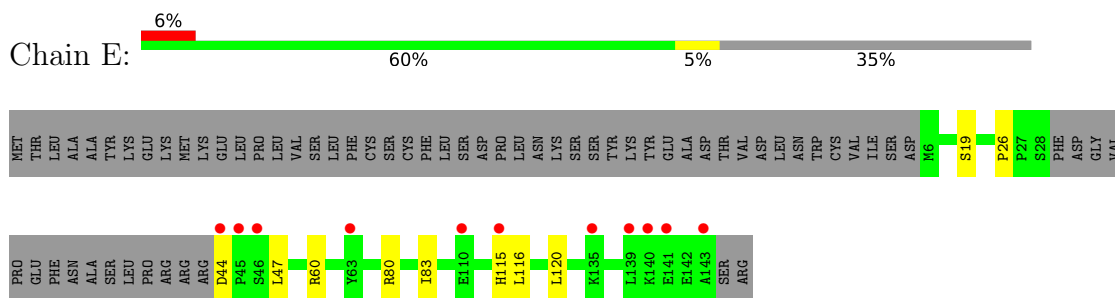

- Molecule 4: TTL

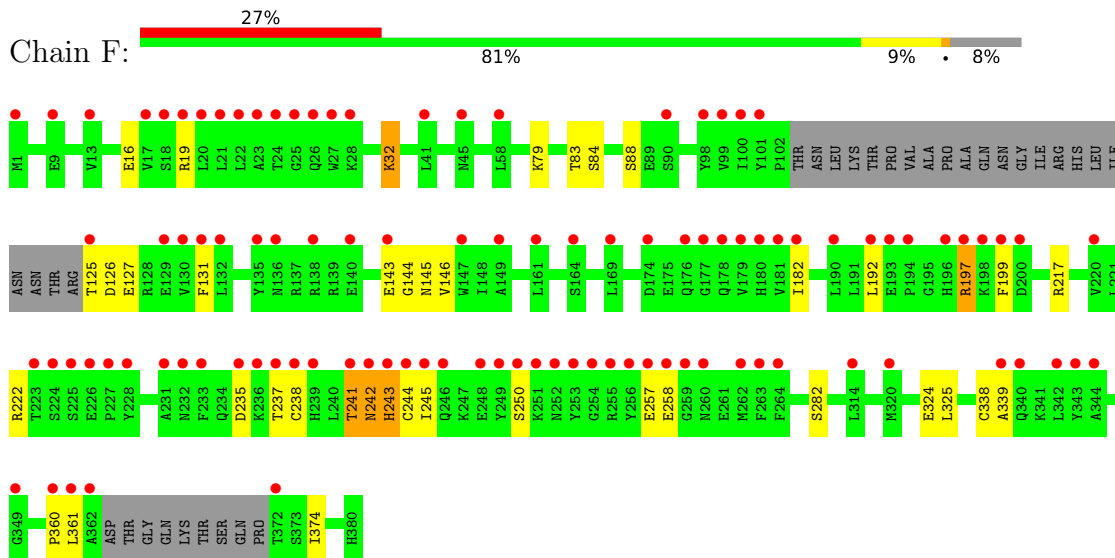

4 Data and refinement statistics

Property	Value	Source
Space group	P 21 21 21	Depositor
Cell constants a, b, c, α , β , γ	104.49Å 157.00Å 180.40Å 90.00° 90.00° 90.00°	Depositor
Resolution (Å)	47.74 – 2.76 47.80 – 2.76	Depositor EDS
% Data completeness (in resolution range)	99.3 (47.74-2.76) 99.3 (47.80-2.76)	Depositor EDS
R_{merge}	(Not available)	Depositor
R_{sym}	(Not available)	Depositor
$\langle I/\sigma(I) \rangle$ ¹	1.24 (at 2.77Å)	Xtrriage
Refinement program	PHENIX 1.18.2_3874	Depositor
R, R_{free}	0.235 , 0.264 0.236 , 0.262	Depositor DCC
R_{free} test set	1143 reflections (1.50%)	wwPDB-VP
Wilson B-factor (Å ²)	70.6	Xtrriage
Anisotropy	0.107	Xtrriage
Bulk solvent k_{sol} (e/Å ³), B_{sol} (Å ²)	0.39 , 43.6	EDS
L-test for twinning ²	$\langle L \rangle = 0.50$, $\langle L^2 \rangle = 0.33$	Xtrriage
Estimated twinning fraction	No twinning to report.	Xtrriage
F_o, F_c correlation	0.92	EDS
Total number of atoms	33734	wwPDB-VP
Average B, all atoms (Å ²)	75.0	wwPDB-VP

Xtrriage's analysis on translational NCS is as follows: *The largest off-origin peak in the Patterson function is 2.75% of the height of the origin peak. No significant pseudotranslation is detected.*

¹Intensities estimated from amplitudes.

²Theoretical values of $\langle |L| \rangle$, $\langle L^2 \rangle$ for acentric reflections are 0.5, 0.333 respectively for untwinned datasets, and 0.375, 0.2 for perfectly twinned datasets.

5 Model quality

5.1 Standard geometry

Bond lengths and bond angles in the following residue types are not validated in this section: ACP, UPO, MES, MG, GTP, CA, GDP, CL

The Z score for a bond length (or angle) is the number of standard deviations the observed value is removed from the expected value. A bond length (or angle) with $|Z| > 5$ is considered an outlier worth inspection. RMSZ is the root-mean-square of all Z scores of the bond lengths (or angles).

Mol	Chain	Bond lengths		Bond angles	
		RMSZ	# Z >5	RMSZ	# Z >5
1	A	0.28	0/3473	0.49	0/4723
1	C	0.30	0/3539	0.48	0/4810
2	B	0.28	0/3380	0.49	0/4588
2	D	0.28	0/3343	0.47	0/4537
3	E	0.28	0/1004	0.41	0/1336
4	F	0.27	0/2754	0.44	0/3741
All	All	0.28	0/17493	0.47	0/23735

There are no bond length outliers.

There are no bond angle outliers.

There are no chirality outliers.

There are no planarity outliers.

5.2 Too-close contacts

In the following table, the Non-H and H(model) columns list the number of non-hydrogen atoms and hydrogen atoms in the chain respectively. The H(added) column lists the number of hydrogen atoms added and optimized by MolProbity. The Clashes column lists the number of clashes within the asymmetric unit, whereas Symm-Clashes lists symmetry-related clashes.

Mol	Chain	Non-H	H(model)	H(added)	Clashes	Symm-Clashes
1	A	3393	3260	3271	22	0
1	C	3448	3331	3344	24	0
2	B	3303	3111	3141	25	0
2	D	3271	3090	3130	30	1
3	E	993	995	998	5	0
4	F	2692	2533	2545	25	1
5	A	32	10	12	0	0

Continued on next page...

Continued from previous page...

Mol	Chain	Non-H	H(model)	H(added)	Clashes	Symm-Clashes
5	C	32	10	12	0	0
5	D	32	10	12	0	0
6	A	1	0	0	0	0
6	B	1	0	0	0	0
6	C	1	0	0	0	0
6	D	1	0	0	0	0
6	F	1	0	0	0	0
7	A	2	0	0	0	0
7	B	2	0	0	0	0
7	C	1	0	0	0	0
7	D	1	0	0	0	0
8	B	12	12	12	0	0
9	B	29	24	0	0	0
10	B	28	10	12	0	0
11	D	1	0	0	0	0
12	F	31	14	14	0	0
13	A	1	0	0	0	0
13	B	2	0	0	0	0
13	C	9	0	0	0	0
13	D	1	0	0	1	0
13	F	3	0	0	0	0
All	All	17324	16410	16503	128	1

The all-atom clashscore is defined as the number of clashes found per 1000 atoms (including hydrogen atoms). The all-atom clashscore for this structure is 4.

All (128) close contacts within the same asymmetric unit are listed below, sorted by their clash magnitude.

Atom-1	Atom-2	Interatomic distance (Å)	Clash overlap (Å)
3:E:116:LEU:O	3:E:120:LEU:HD12	1.88	0.72
2:D:145:SER:OG	2:D:188:SER:OG	2.07	0.67
2:B:235:GLY:O	2:B:238:THR:HG22	1.94	0.66
1:A:178:SER:OG	1:A:183:GLU:OE2	2.17	0.63
1:A:187:SER:CB	1:A:391:LEU:HD21	2.31	0.60
2:D:91:VAL:HG11	2:D:116:VAL:HG22	1.83	0.60
2:B:145:SER:OG	2:B:188:SER:OG	2.19	0.60
4:F:241:THR:O	4:F:241:THR:OG1	2.19	0.60
1:C:278:ALA:HA	1:C:369:ALA:HB2	1.84	0.59
2:B:81:PHE:O	2:B:84:ILE:HG22	2.02	0.59
1:A:187:SER:HB3	1:A:391:LEU:HD21	1.84	0.59
2:B:293:MET:CE	2:B:373:ALA:HB1	2.32	0.59

Continued on next page...

Continued from previous page...

Atom-1	Atom-2	Interatomic distance (Å)	Clash overlap (Å)
2:B:186:THR:HG23	2:B:423:MET:HE2	1.84	0.58
4:F:237:THR:OG1	4:F:250:SER:OG	2.19	0.58
4:F:217:ARG:NH2	4:F:374:ILE:HG22	2.18	0.58
4:F:79:LYS:O	4:F:83:THR:OG1	2.13	0.58
2:B:398:ARG:NH1	1:C:439:SER:OG	2.37	0.57
2:B:117:LEU:HD21	2:B:154:LYS:HB3	1.86	0.56
2:D:246:LEU:HD22	2:D:352:ALA:HB2	1.87	0.56
2:B:161:ASP:O	2:B:251:ARG:NH2	2.39	0.56
2:D:347:ASN:O	2:D:350:LYS:NZ	2.39	0.56
1:A:188:ILE:HG23	1:A:425:MET:HG3	1.87	0.55
2:D:48:ASN:N	2:D:48:ASN:OD1	2.40	0.54
4:F:243:HIS:C	4:F:243:HIS:HD1	2.11	0.54
1:C:344:VAL:HG21	1:C:346:TRP:CE2	2.43	0.53
1:C:2:ARG:HA	1:C:131:GLY:O	2.08	0.53
1:C:293:ASN:OD1	1:C:335:ILE:HD11	2.09	0.53
1:C:187:SER:CB	1:C:391:LEU:HD21	2.40	0.52
4:F:192:LEU:HD11	4:F:199:PHE:CD2	2.44	0.52
1:A:188:ILE:HD12	1:A:425:MET:HG3	1.92	0.51
2:D:91:VAL:HG11	2:D:116:VAL:CG2	2.40	0.51
4:F:143:GLU:O	4:F:145:ASN:N	2.43	0.51
2:B:202:ILE:HD13	2:B:229:VAL:HG13	1.92	0.51
2:D:247:ASN:HB3	2:D:253:LEU:HB2	1.93	0.51
1:A:414:GLU:OE2	3:E:60:ARG:NH1	2.44	0.51
2:B:272:PRO:HB3	2:B:284:LEU:HD22	1.91	0.51
1:C:36:MET:HE3	1:C:49:PHE:CZ	2.45	0.51
2:B:293:MET:HE3	2:B:373:ALA:HB1	1.92	0.50
4:F:237:THR:HG1	4:F:250:SER:HG	1.52	0.50
1:C:18:ASN:HD21	1:C:78:VAL:HG22	1.76	0.50
2:D:301:ALA:O	2:D:303:CYS:N	2.45	0.50
2:D:163:ILE:HD11	2:D:251:ARG:HB2	1.93	0.49
1:C:230:LEU:O	1:C:234:ILE:HD12	2.13	0.49
2:D:81:PHE:O	2:D:84:ILE:HG22	2.11	0.49
4:F:131:PHE:CE1	4:F:182:ILE:HG21	2.48	0.49
1:C:225:THR:O	1:C:229:ARG:HG3	2.12	0.49
2:D:274:THR:O	2:D:275:SER:CB	2.60	0.49
1:A:230:LEU:O	1:A:234:ILE:HD12	2.13	0.49
2:B:323:MET:O	2:B:326:VAL:HG22	2.12	0.49
2:D:239:CYS:HB3	2:D:247:ASN:O	2.12	0.49
2:B:121:ARG:NH1	2:B:158:GLU:OE1	2.45	0.49
1:C:190:THR:O	1:C:194:THR:HG23	2.12	0.48
2:D:439:ASP:OD1	13:D:601:HOH:O	2.20	0.48

Continued on next page...

Continued from previous page...

Atom-1	Atom-2	Interatomic distance (Å)	Clash overlap (Å)
4:F:242:ASN:N	4:F:242:ASN:OD1	2.44	0.48
2:D:65:LEU:HD12	2:D:65:LEU:N	2.29	0.48
2:D:116:VAL:O	2:D:119:VAL:HG12	2.14	0.48
1:A:18:ASN:HD21	1:A:78:VAL:HG22	1.77	0.48
1:C:16:ILE:CD1	1:C:171:ILE:HD11	2.43	0.48
1:A:209:ILE:HD11	1:A:302:MET:HE3	1.94	0.48
3:E:80:ARG:HA	3:E:83:ILE:HG22	1.96	0.47
1:A:36:MET:HB3	1:A:61:HIS:CE1	2.49	0.47
1:C:187:SER:HB3	1:C:391:LEU:HD21	1.97	0.47
1:C:318:LEU:HD12	1:C:318:LEU:N	2.29	0.47
1:A:203:MET:HE1	1:A:388:TRP:CH2	2.50	0.47
1:A:265:ILE:HG23	1:A:432:TYR:CZ	2.51	0.46
1:C:36:MET:HE2	1:C:39:ASP:HB2	1.98	0.46
4:F:197:ARG:NH2	4:F:257:GLU:OE2	2.49	0.46
2:D:249:ASP:OD1	2:D:250:LEU:N	2.49	0.46
2:D:345:ILE:HG22	2:D:348:ASN:HB3	1.98	0.46
2:D:15:GLN:O	2:D:19:LYS:HG2	2.15	0.46
2:B:20:PHE:HB2	2:B:233:MET:HE3	1.98	0.46
2:B:327:ASP:O	2:B:331:LEU:HG	2.16	0.46
1:C:181[A]:VAL:HG21	1:C:404:PHE:CZ	2.51	0.46
1:C:214:ARG:HG2	1:C:219:ILE:O	2.16	0.45
1:C:188:ILE:HG23	1:C:425:MET:HG3	1.98	0.45
4:F:192:LEU:H	4:F:192:LEU:HD12	1.80	0.45
2:B:67:ASP:HA	2:B:143:THR:HG21	1.99	0.45
2:D:65:LEU:CD2	2:D:76:VAL:HG11	2.47	0.45
4:F:126:ASP:OD1	4:F:127:GLU:N	2.50	0.45
2:B:301:ALA:O	2:B:303:CYS:N	2.46	0.45
4:F:282:SER:HB2	4:F:325:LEU:HD13	1.99	0.45
1:A:79:ARG:HG2	1:A:92:LEU:HD12	1.98	0.44
2:D:242:PHE:CD1	2:D:356:ILE:CD1	3.00	0.44
1:A:316:CYS:HA	1:A:352:LYS:O	2.18	0.44
2:D:12:CYS:SG	2:D:169:VAL:HG21	2.58	0.44
2:D:68:LEU:O	2:D:96:GLY:N	2.51	0.44
2:D:179:VAL:O	2:D:396:MET:HE1	2.18	0.44
4:F:32:LYS:HD2	4:F:32:LYS:H	1.83	0.44
4:F:244:CYS:SG	4:F:245:ILE:N	2.91	0.43
2:B:293:MET:HE1	2:B:373:ALA:HB1	2.00	0.43
1:C:165:SER:HA	1:C:199:ASP:OD2	2.19	0.43
2:D:246:LEU:HD11	2:D:350:LYS:HB3	2.00	0.43
1:A:247:ALA:HB3	3:E:19:SER:OG	2.19	0.43
2:B:286:VAL:HG13	2:B:326:VAL:HG12	2.01	0.43

Continued on next page...

Continued from previous page...

Atom-1	Atom-2	Interatomic distance (Å)	Clash overlap (Å)
2:D:64:ILE:HD13	2:D:120:VAL:HG22	2.01	0.43
1:A:172:TYR:HB3	1:A:205:ASP:HA	2.01	0.43
1:A:214:ARG:HB3	1:A:219:ILE:O	2.18	0.43
3:E:47:LEU:C	3:E:47:LEU:HD23	2.39	0.43
2:D:245:GLN:O	2:D:246:LEU:O	2.36	0.43
4:F:125:THR:OG1	4:F:126:ASP:N	2.52	0.43
4:F:192:LEU:HD12	4:F:192:LEU:N	2.35	0.42
1:C:345:ASP:OD2	1:C:439:SER:N	2.49	0.42
2:D:385:LEU:C	2:D:385:LEU:HD23	2.39	0.42
4:F:243:HIS:C	4:F:243:HIS:ND1	2.71	0.42
1:A:213:CYS:O	1:A:217:LEU:HB2	2.20	0.42
4:F:338:CYS:SG	4:F:339:ALA:N	2.93	0.42
4:F:131:PHE:CZ	4:F:182:ILE:HG21	2.54	0.42
1:C:320:ARG:HA	1:C:356:ASN:O	2.20	0.42
2:D:169:VAL:HA	2:D:202:ILE:O	2.20	0.42
2:B:173:PRO:HA	2:B:176:SER:HB2	2.02	0.41
2:B:229:VAL:HG12	2:B:233:MET:HE2	2.02	0.41
4:F:360:PRO:C	4:F:361:LEU:HD12	2.40	0.41
2:D:1:MET:N	2:D:48:ASN:ND2	2.68	0.41
2:D:293:MET:CG	2:D:375:PHE:HB2	2.51	0.41
2:B:170:VAL:HG13	2:B:171:PRO:HD2	2.02	0.41
2:B:251:ARG:O	2:B:255:VAL:HG23	2.21	0.41
2:B:48:ASN:OD1	2:B:48:ASN:N	2.53	0.41
1:A:331:ALA:O	1:A:335:ILE:HG12	2.21	0.41
4:F:84:SER:O	4:F:88:SER:N	2.51	0.41
1:A:28:HIS:HB3	1:A:36:MET:HE3	2.03	0.41
1:A:234:ILE:HD12	1:A:234:ILE:H	1.86	0.41
4:F:238:CYS:O	4:F:238:CYS:SG	2.79	0.41
2:B:244:GLY:O	2:B:245:GLN:C	2.59	0.41
1:C:181[B]:VAL:HG21	1:C:404:PHE:CZ	2.56	0.40
1:A:269:LEU:N	1:A:379:SER:O	2.36	0.40
1:C:16:ILE:HD13	1:C:171:ILE:HD11	2.03	0.40
1:C:36:MET:CE	1:C:39:ASP:HB2	2.52	0.40
4:F:16:GLU:OE2	4:F:19:ARG:NH2	2.55	0.40

All (1) symmetry-related close contacts are listed below. The label for Atom-2 includes the symmetry operator and encoded unit-cell translations to be applied.

Atom-1	Atom-2	Interatomic distance (Å)	Clash overlap (Å)
2:D:213:ARG:HH22	4:F:324:GLU:OE1[3_545]	1.56	0.04

5.3 Torsion angles [i](#)

5.3.1 Protein backbone [i](#)

In the following table, the Percentiles column shows the percent Ramachandran outliers of the chain as a percentile score with respect to all X-ray entries followed by that with respect to entries of similar resolution.

The Analysed column shows the number of residues for which the backbone conformation was analysed, and the total number of residues.

Mol	Chain	Analysed	Favoured	Allowed	Outliers	Percentiles	
1	A	438/451 (97%)	429 (98%)	9 (2%)	0	100	100
1	C	443/451 (98%)	432 (98%)	11 (2%)	0	100	100
2	B	422/431 (98%)	409 (97%)	13 (3%)	0	100	100
2	D	419/431 (97%)	405 (97%)	13 (3%)	1 (0%)	47	69
3	E	121/189 (64%)	120 (99%)	1 (1%)	0	100	100
4	F	343/380 (90%)	326 (95%)	14 (4%)	3 (1%)	17	31
All	All	2186/2333 (94%)	2121 (97%)	61 (3%)	4 (0%)	47	69

All (4) Ramachandran outliers are listed below:

Mol	Chain	Res	Type
2	D	246	LEU
4	F	144	GLY
4	F	243	HIS
4	F	258	GLU

5.3.2 Protein sidechains [i](#)

In the following table, the Percentiles column shows the percent sidechain outliers of the chain as a percentile score with respect to all X-ray entries followed by that with respect to entries of similar resolution.

The Analysed column shows the number of residues for which the sidechain conformation was analysed, and the total number of residues.

Mol	Chain	Analysed	Rotameric	Outliers	Percentiles	
1	A	362/379 (96%)	360 (99%)	2 (1%)	86	90
1	C	372/379 (98%)	371 (100%)	1 (0%)	92	95
2	B	355/370 (96%)	353 (99%)	2 (1%)	86	90

Continued on next page...

Continued from previous page...

Mol	Chain	Analysed	Rotameric	Outliers	Percentiles	
2	D	353/370 (95%)	349 (99%)	4 (1%)	73	84
3	E	104/171 (61%)	101 (97%)	3 (3%)	42	62
4	F	273/338 (81%)	266 (97%)	7 (3%)	46	66
All	All	1819/2007 (91%)	1800 (99%)	19 (1%)	73	85

All (19) residues with a non-rotameric sidechain are listed below:

Mol	Chain	Res	Type
1	A	176	GLN
1	A	256	GLN
2	B	190	HIS
2	B	309	ARG
1	C	251	ASP
2	D	75	SER
2	D	77	ARG
2	D	306	ARG
2	D	355	ASP
3	E	26	PRO
3	E	44	ASP
3	E	115	HIS
4	F	32	LYS
4	F	146	VAL
4	F	197	ARG
4	F	222	ARG
4	F	235	ASP
4	F	241	THR
4	F	242	ASN

Sometimes sidechains can be flipped to improve hydrogen bonding and reduce clashes. There are no such sidechains identified.

5.3.3 RNA [i](#)

There are no RNA molecules in this entry.

5.4 Non-standard residues in protein, DNA, RNA chains [i](#)

There are no non-standard protein/DNA/RNA residues in this entry.

5.5 Carbohydrates [i](#)

There are no monosaccharides in this entry.

5.6 Ligand geometry [i](#)

Of 19 ligands modelled in this entry, 12 are monoatomic - leaving 7 for Mogul analysis.

In the following table, the Counts columns list the number of bonds (or angles) for which Mogul statistics could be retrieved, the number of bonds (or angles) that are observed in the model and the number of bonds (or angles) that are defined in the Chemical Component Dictionary. The Link column lists molecule types, if any, to which the group is linked. The Z score for a bond length (or angle) is the number of standard deviations the observed value is removed from the expected value. A bond length (or angle) with $|Z| > 2$ is considered an outlier worth inspection. RMSZ is the root-mean-square of all Z scores of the bond lengths (or angles).

Mol	Type	Chain	Res	Link	Bond lengths			Bond angles		
					Counts	RMSZ	# Z > 2	Counts	RMSZ	# Z > 2
5	GTP	A	501	6	26,34,34	1.12	2 (7%)	32,54,54	1.54	7 (21%)
9	UPO	B	505	-	32,32,32	1.72	7 (21%)	45,45,45	1.90	9 (20%)
5	GTP	D	503	6	26,34,34	1.13	2 (7%)	32,54,54	1.55	6 (18%)
8	MES	B	502	-	12,12,12	2.25	1 (8%)	14,16,16	1.75	5 (35%)
12	ACP	F	402	6	27,33,33	1.35	5 (18%)	32,52,52	1.50	4 (12%)
5	GTP	C	501	6	26,34,34	1.11	2 (7%)	32,54,54	1.57	7 (21%)
10	GDP	B	506	6	24,30,30	0.92	1 (4%)	30,47,47	1.28	5 (16%)

In the following table, the Chirals column lists the number of chiral outliers, the number of chiral centers analysed, the number of these observed in the model and the number defined in the Chemical Component Dictionary. Similar counts are reported in the Torsion and Rings columns. '-' means no outliers of that kind were identified.

Mol	Type	Chain	Res	Link	Chirals	Torsions	Rings
5	GTP	A	501	6	-	4/18/38/38	0/3/3/3
9	UPO	B	505	-	-	4/14/23/23	0/4/4/4
5	GTP	D	503	6	-	4/18/38/38	0/3/3/3
8	MES	B	502	-	-	1/6/14/14	0/1/1/1
12	ACP	F	402	6	-	6/15/38/38	0/3/3/3
5	GTP	C	501	6	-	7/18/38/38	0/3/3/3
10	GDP	B	506	6	-	0/12/32/32	0/3/3/3

All (20) bond length outliers are listed below:

Mol	Chain	Res	Type	Atoms	Z	Observed(Å)	Ideal(Å)
8	B	502	MES	C8-S	-7.54	1.66	1.77
9	B	505	UPO	C10-N11	5.91	1.49	1.37
5	A	501	GTP	C5-C6	-4.07	1.39	1.47
5	D	503	GTP	C5-C6	-4.01	1.39	1.47
5	C	501	GTP	C5-C6	-3.95	1.39	1.47
9	B	505	UPO	C12-N11	3.76	1.52	1.46
9	B	505	UPO	C26-N25	2.95	1.40	1.35
12	F	402	ACP	PG-O3G	2.87	1.61	1.54
12	F	402	ACP	PG-O2G	2.85	1.61	1.54
9	B	505	UPO	C12-C13	2.49	1.56	1.51
12	F	402	ACP	PB-O3A	2.46	1.61	1.58
12	F	402	ACP	C5-C4	2.44	1.47	1.40
10	B	506	GDP	C6-N1	-2.33	1.34	1.37
9	B	505	UPO	C10-N25	2.26	1.37	1.34
5	A	501	GTP	C2-N3	2.23	1.38	1.33
5	C	501	GTP	C2-N3	2.19	1.38	1.33
5	D	503	GTP	C2-N3	2.16	1.38	1.33
9	B	505	UPO	C26-N28	2.07	1.39	1.35
12	F	402	ACP	PB-O2B	2.06	1.61	1.56
9	B	505	UPO	C26-N27	2.02	1.38	1.33

All (43) bond angle outliers are listed below:

Mol	Chain	Res	Type	Atoms	Z	Observed(°)	Ideal(°)
9	B	505	UPO	N25-C10-N11	5.75	123.00	116.55
9	B	505	UPO	C09-C10-N11	-4.94	116.42	122.29
9	B	505	UPO	C08-C09-C10	4.82	120.19	117.03
5	A	501	GTP	PB-O3B-PG	-4.19	118.44	132.83
8	B	502	MES	C5-N4-C3	4.18	118.23	108.83
12	F	402	ACP	PB-O3A-PA	-4.10	119.55	132.56
5	C	501	GTP	PB-O3B-PG	-3.84	119.65	132.83
12	F	402	ACP	N3-C2-N1	-3.64	122.99	128.68
12	F	402	ACP	C3'-C2'-C1'	3.51	106.26	100.98
9	B	505	UPO	C12-C13-C14	3.49	117.56	111.35
9	B	505	UPO	C08-N28-C26	-3.39	114.40	116.34
5	D	503	GTP	PA-O3A-PB	-3.30	121.49	132.83
5	D	503	GTP	PB-O3B-PG	-3.29	121.55	132.83
5	C	501	GTP	C5-C6-N1	3.26	119.70	113.95
5	A	501	GTP	C5-C6-N1	3.16	119.53	113.95
5	D	503	GTP	C5-C6-N1	3.12	119.45	113.95
5	D	503	GTP	C8-N7-C5	3.06	108.81	102.99
9	B	505	UPO	C21-O20-C19	-3.01	112.98	117.53
5	C	501	GTP	C8-N7-C5	3.01	108.72	102.99

Continued on next page...

Continued from previous page...

Mol	Chain	Res	Type	Atoms	Z	Observed(°)	Ideal(°)
10	B	506	GDP	PA-O3A-PB	-2.99	122.57	132.83
9	B	505	UPO	O20-C19-C16	2.96	119.54	115.41
5	D	503	GTP	C2-N1-C6	-2.92	119.72	125.10
5	A	501	GTP	C8-N7-C5	2.92	108.55	102.99
5	C	501	GTP	C2-N1-C6	-2.90	119.75	125.10
5	A	501	GTP	PA-O3A-PB	-2.90	122.89	132.83
5	A	501	GTP	C2-N1-C6	-2.84	119.87	125.10
10	B	506	GDP	C3'-C2'-C1'	2.82	105.22	100.98
5	C	501	GTP	PA-O3A-PB	-2.75	123.38	132.83
5	C	501	GTP	C3'-C2'-C1'	2.58	104.86	100.98
12	F	402	ACP	C4-C5-N7	-2.53	106.76	109.40
9	B	505	UPO	C26-N25-C10	-2.49	114.97	116.73
8	B	502	MES	O3S-S-C8	2.36	109.58	105.77
10	B	506	GDP	C8-N7-C5	2.35	107.47	102.99
10	B	506	GDP	C5-C6-N1	2.24	117.91	113.95
5	A	501	GTP	C3'-C2'-C1'	2.20	104.29	100.98
8	B	502	MES	O1S-S-C8	2.18	109.54	106.92
5	A	501	GTP	O6-C6-C5	-2.15	120.18	124.37
5	D	503	GTP	O6-C6-C5	-2.14	120.19	124.37
5	C	501	GTP	O6-C6-C5	-2.14	120.20	124.37
8	B	502	MES	C7-N4-C5	2.08	116.55	111.23
8	B	502	MES	O2S-S-C8	2.08	109.41	106.92
10	B	506	GDP	C2'-C3'-C4'	2.07	106.66	102.64
9	B	505	UPO	N27-C26-N28	-2.06	114.05	117.25

There are no chirality outliers.

All (26) torsion outliers are listed below:

Mol	Chain	Res	Type	Atoms
5	A	501	GTP	C5'-O5'-PA-O3A
5	C	501	GTP	C5'-O5'-PA-O3A
5	C	501	GTP	C5'-O5'-PA-O2A
12	F	402	ACP	PG-C3B-PB-O1B
12	F	402	ACP	PG-C3B-PB-O3A
12	F	402	ACP	C5'-O5'-PA-O1A
12	F	402	ACP	C5'-O5'-PA-O2A
9	B	505	UPO	C04-C03-O02-C01
9	B	505	UPO	C29-C03-O02-C01
9	B	505	UPO	C22-C19-O20-C21
9	B	505	UPO	C16-C19-O20-C21
5	D	503	GTP	PA-O3A-PB-O3B
5	C	501	GTP	PB-O3B-PG-O1G

Continued on next page...

Continued from previous page...

Mol	Chain	Res	Type	Atoms
5	D	503	GTP	C4'-C5'-O5'-PA
5	A	501	GTP	PB-O3A-PA-O2A
5	C	501	GTP	PB-O3A-PA-O2A
5	A	501	GTP	C4'-C5'-O5'-PA
5	C	501	GTP	C4'-C5'-O5'-PA
5	A	501	GTP	C5'-O5'-PA-O2A
12	F	402	ACP	PG-C3B-PB-O2B
8	B	502	MES	C8-C7-N4-C3
5	C	501	GTP	PB-O3B-PG-O2G
5	C	501	GTP	PB-O3B-PG-O3G
5	D	503	GTP	C5'-O5'-PA-O3A
12	F	402	ACP	C5'-O5'-PA-O3A
5	D	503	GTP	PA-O3A-PB-O1B

There are no ring outliers.

No monomer is involved in short contacts.

The following is a two-dimensional graphical depiction of Mogul quality analysis of bond lengths, bond angles, torsion angles, and ring geometry for all instances of the Ligand of Interest. In addition, ligands with molecular weight > 250 and outliers as shown on the validation Tables will also be included. For torsion angles, if less than 5% of the Mogul distribution of torsion angles is within 10 degrees of the torsion angle in question, then that torsion angle is considered an outlier. Any bond that is central to one or more torsion angles identified as an outlier by Mogul will be highlighted in the graph. For rings, the root-mean-square deviation (RMSD) between the ring in question and similar rings identified by Mogul is calculated over all ring torsion angles. If the average RMSD is greater than 60 degrees and the minimal RMSD between the ring in question and any Mogul-identified rings is also greater than 60 degrees, then that ring is considered an outlier. The outliers are highlighted in purple. The color gray indicates Mogul did not find sufficient equivalents in the CSD to analyse the geometry.

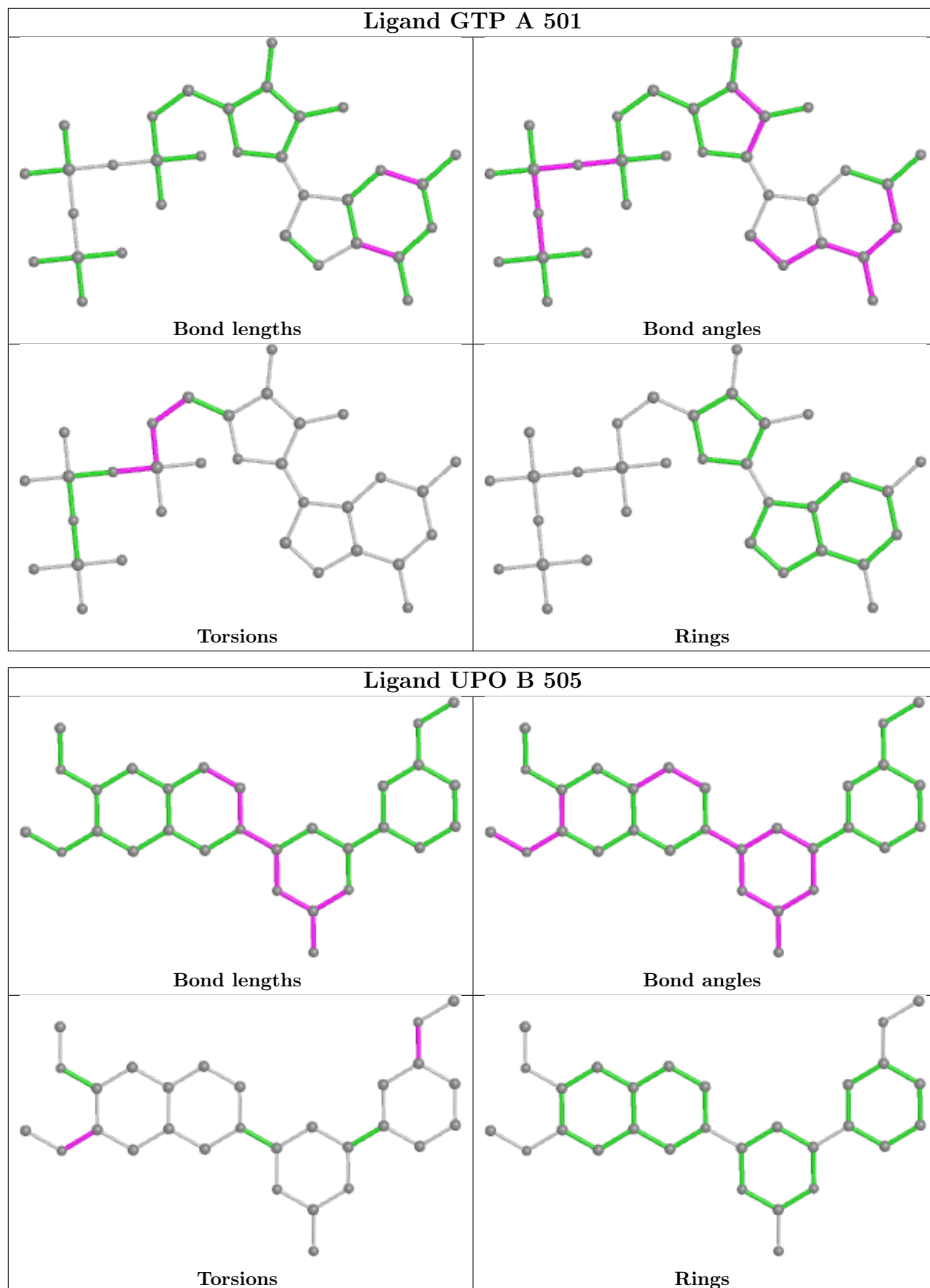

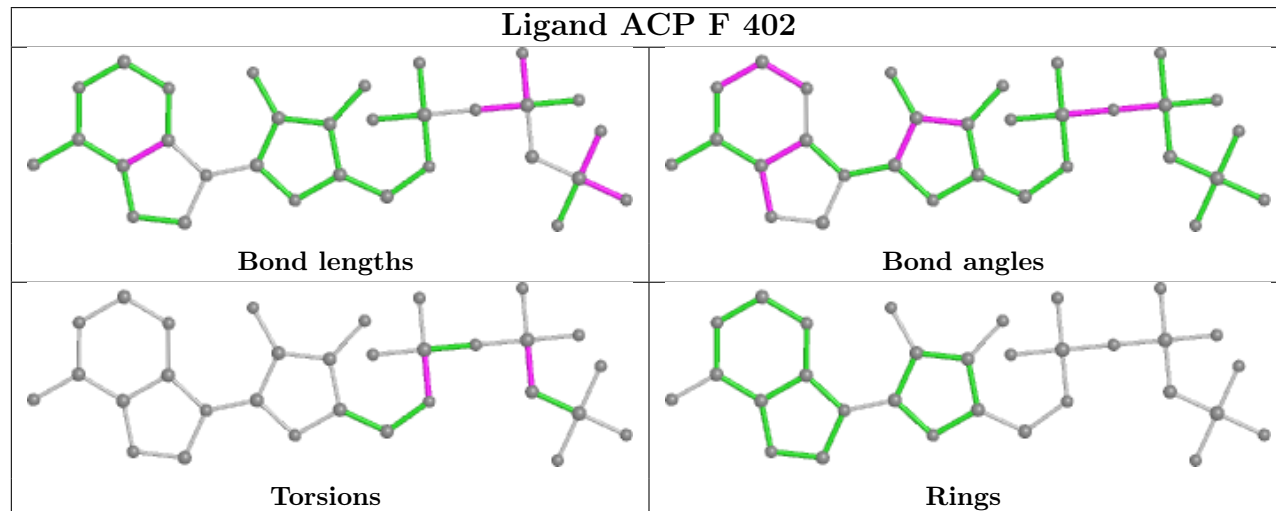
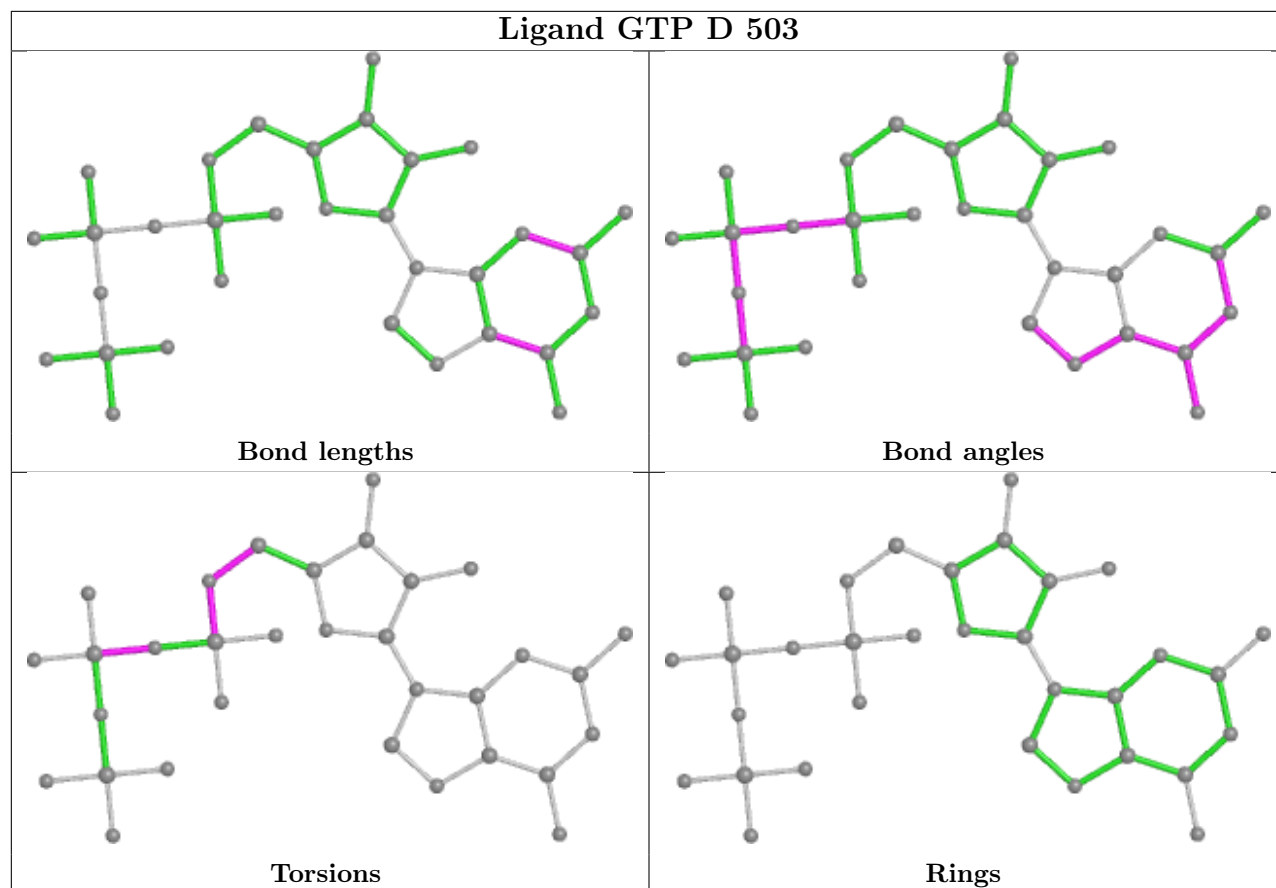

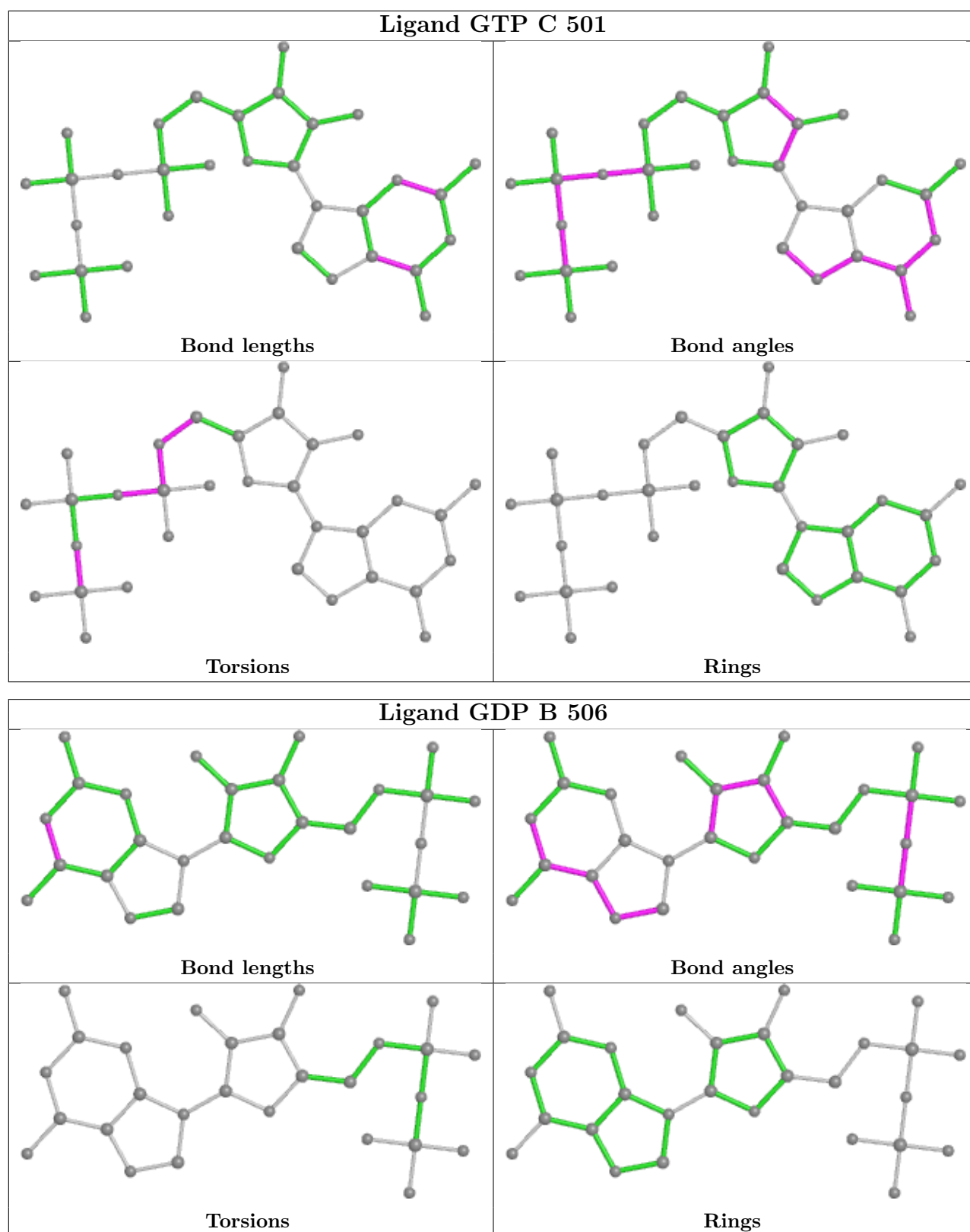

5.7 Other polymers [i](#)

There are no such residues in this entry.

5.8 Polymer linkage issues

There are no chain breaks in this entry.

6 Fit of model and data

6.1 Protein, DNA and RNA chains

In the following table, the column labelled ‘#RSRZ > 2’ contains the number (and percentage) of RSRZ outliers, followed by percent RSRZ outliers for the chain as percentile scores relative to all X-ray entries and entries of similar resolution. The OWAB column contains the minimum, median, 95th percentile and maximum values of the occupancy-weighted average B-factor per residue. The column labelled ‘Q < 0.9’ lists the number of (and percentage) of residues with an average occupancy less than 0.9.

Mol	Chain	Analysed	<RSRZ>	#RSRZ>2	OWAB(Å ²)	Q<0.9
1	A	438/451 (97%)	0.76	33 (7%) 14 17	48, 63, 81, 97	0
1	C	440/451 (97%)	0.45	5 (1%) 80 86	40, 54, 68, 83	0
2	B	425/431 (98%)	0.72	30 (7%) 16 19	42, 63, 90, 106	0
2	D	423/431 (98%)	1.00	66 (15%) 2 2	53, 75, 93, 104	0
3	E	123/189 (65%)	0.72	11 (8%) 9 11	57, 73, 104, 115	0
4	F	349/380 (91%)	1.56	104 (29%) 0 0	59, 85, 131, 142	0
All	All	2198/2333 (94%)	0.86	249 (11%) 5 6	40, 67, 104, 142	0

All (249) RSRZ outliers are listed below:

Mol	Chain	Res	Type	RSRZ
4	F	253	TYR	8.8
4	F	250	SER	8.4
4	F	254	GLY	8.2
4	F	256	TYR	6.7
4	F	178	GLN	6.0
4	F	99	VAL	5.9
4	F	100	ILE	5.9
4	F	361	LEU	5.9
4	F	182	ILE	5.7
4	F	177	GLY	5.4
4	F	225	SER	5.3
4	F	249	TYR	5.3
4	F	251	LYS	5.1
4	F	179	VAL	5.1
4	F	362	ALA	5.1
4	F	169	LEU	4.9
4	F	17	VAL	4.9
4	F	136	ASN	4.9
4	F	231	ALA	4.9

Continued on next page...

Continued from previous page...

Mol	Chain	Res	Type	RSRZ
4	F	226	GLU	4.9
2	B	36	TYR	4.8
4	F	233	PHE	4.8
4	F	255	ARG	4.8
4	F	130	VAL	4.8
4	F	228	TYR	4.6
4	F	20	LEU	4.6
4	F	176	GLN	4.4
4	F	132	LEU	4.4
4	F	125	THR	4.4
2	B	60	VAL	4.4
4	F	197	ARG	4.3
4	F	239	HIS	4.3
4	F	196	HIS	4.2
4	F	241	THR	4.2
4	F	339	ALA	4.2
2	D	403	LEU	4.1
3	E	46	SER	4.1
2	D	275	SER	4.1
4	F	25	GLY	4.1
4	F	192	LEU	4.0
2	B	37	HIS	4.0
3	E	135	LYS	4.0
2	B	43	GLN	3.9
1	A	62	VAL	3.9
1	A	262	TYR	3.9
2	D	37	HIS	3.8
4	F	21	LEU	3.8
4	F	223	THR	3.8
4	F	131	PHE	3.8
2	B	59	TYR	3.7
4	F	22	LEU	3.7
1	A	1	MET	3.7
4	F	27	TRP	3.7
2	D	175	VAL	3.7
1	A	54	SER	3.7
4	F	224	SER	3.7
2	B	437	THR	3.7
2	B	436	ALA	3.7
2	D	73	MET	3.6
4	F	360	PRO	3.6
4	F	344	ALA	3.6

Continued on next page...

Continued from previous page...

Mol	Chain	Res	Type	RSRZ
2	D	57	ASN	3.6
4	F	26	GLN	3.6
2	D	59	TYR	3.6
4	F	138	ARG	3.5
2	D	218	THR	3.5
4	F	101	TYR	3.5
4	F	13	VAL	3.5
4	F	199	PHE	3.5
2	D	219	THR	3.5
4	F	246	GLN	3.5
4	F	262	MET	3.5
4	F	340	GLN	3.4
1	C	340	SER	3.4
2	D	398	ARG	3.4
4	F	190	LEU	3.4
2	D	58	LYS	3.4
1	A	131	GLY	3.4
4	F	259	GLY	3.4
2	B	81	PHE	3.4
4	F	320	MET	3.4
4	F	180	HIS	3.3
4	F	237	THR	3.3
3	E	45	PRO	3.3
2	D	69	GLU	3.3
4	F	252	ASN	3.3
2	D	55	ALA	3.3
4	F	24	THR	3.2
2	D	100	ASN	3.2
4	F	264	PHE	3.2
1	A	46	ASP	3.2
4	F	227	PRO	3.2
2	D	35	SER	3.2
4	F	257	GLU	3.2
2	B	55	ALA	3.2
1	A	86	LEU	3.2
4	F	258	GLU	3.1
4	F	236	LYS	3.1
2	D	177	ASP	3.1
2	B	38	GLY	3.1
4	F	232	ASN	3.1
2	D	399	ARG	3.1
2	D	56	GLY	3.1

Continued on next page...

Continued from previous page...

Mol	Chain	Res	Type	RSRZ
2	D	413	GLU	3.1
2	B	438	ALA	3.0
4	F	147	TRP	3.0
4	F	90	SER	3.0
4	F	23	ALA	3.0
2	D	30	ILE	3.0
4	F	263	PHE	3.0
1	A	61	HIS	2.9
3	E	143	ALA	2.9
2	D	274	THR	2.9
2	B	274	THR	2.9
4	F	260	ASN	2.9
4	F	238	CYS	2.9
1	A	201	ALA	2.9
2	D	74	ASP	2.9
2	D	91	VAL	2.9
2	D	253	LEU	2.8
2	D	77	ARG	2.8
4	F	1	MET	2.8
2	B	57	ASN	2.8
4	F	143	GLU	2.8
2	B	35	SER	2.8
4	F	98	TYR	2.8
4	F	161	LEU	2.8
2	B	275	SER	2.7
4	F	28	LYS	2.7
2	D	36	TYR	2.7
3	E	115	HIS	2.7
3	E	141	GLU	2.7
4	F	235	ASP	2.7
1	A	125	LEU	2.7
2	D	402	PHE	2.7
1	C	341	ILE	2.7
1	A	364	PRO	2.6
4	F	194	PRO	2.6
2	D	165	ASN	2.6
1	C	85	GLN	2.6
2	B	30	ILE	2.6
4	F	164	SER	2.6
4	F	243	HIS	2.6
4	F	129	GLU	2.6
1	A	42	ILE	2.6

Continued on next page...

Continued from previous page...

Mol	Chain	Res	Type	RSRZ
2	D	33	THR	2.6
2	B	247	ASN	2.6
4	F	245	ILE	2.6
2	D	216	LYS	2.5
2	D	72	THR	2.5
4	F	149	ALA	2.5
1	A	170	SER	2.5
4	F	181	VAL	2.5
1	A	346	TRP	2.5
2	D	200	TYR	2.5
2	D	83	GLN	2.5
1	A	276	ILE	2.5
1	A	137	VAL	2.5
1	A	88	HIS	2.4
2	D	54	ALA	2.4
4	F	198	LYS	2.4
1	A	58	ALA	2.4
2	D	78	SER	2.4
2	D	247	ASN	2.4
2	B	92	PHE	2.4
2	D	197	ASP	2.4
1	C	253	THR	2.4
2	D	254	ALA	2.4
2	D	11	GLN	2.4
2	D	332	ASN	2.4
4	F	19	ARG	2.4
1	A	132	LEU	2.4
4	F	244	CYS	2.4
2	D	84	ILE	2.4
4	F	248	GLU	2.4
2	D	93	GLY	2.4
1	A	279	GLU	2.4
1	A	372	GLN	2.3
1	A	30	ILE	2.3
3	E	110	GLU	2.3
2	D	101	TRP	2.3
1	A	203	MET	2.3
4	F	45	ASN	2.3
2	B	84	ILE	2.3
1	C	440	VAL	2.3
2	D	90	PHE	2.3
3	E	44	ASP	2.3

Continued on next page...

Continued from previous page...

Mol	Chain	Res	Type	RSRZ
1	A	31	GLN	2.3
4	F	342	LEU	2.3
2	B	170	VAL	2.3
2	D	67	ASP	2.3
2	D	105	HIS	2.3
2	D	248	ALA	2.3
2	B	47	ILE	2.3
2	B	39	ASP	2.3
1	A	139	HIS	2.3
2	B	58	LYS	2.3
2	B	122	LYS	2.3
2	D	370	LYS	2.3
4	F	220	VAL	2.3
4	F	174	ASP	2.3
1	A	268	PRO	2.3
4	F	9	GLU	2.3
4	F	140	GLU	2.3
2	D	81	PHE	2.3
2	B	34	GLY	2.2
4	F	200	ASP	2.2
1	A	360	PRO	2.2
2	D	70	PRO	2.2
1	A	138	PHE	2.2
2	D	99	ASN	2.2
4	F	372	THR	2.2
2	D	85	PHE	2.2
2	D	97	ALA	2.2
3	E	140	LYS	2.2
1	A	140	SER	2.2
1	A	171	ILE	2.2
2	D	60	VAL	2.2
2	B	44	LEU	2.2
4	F	242	ASN	2.1
2	D	80	PRO	2.1
2	D	29	GLY	2.1
2	D	377	GLY	2.1
4	F	349	GLY	2.1
2	D	199	THR	2.1
3	E	139	LEU	2.1
4	F	193	GLU	2.1
1	A	169	PHE	2.1
4	F	135	TYR	2.1

Continued on next page...

Continued from previous page...

Mol	Chain	Res	Type	RSRZ
4	F	18	SER	2.1
2	D	112	LEU	2.1
3	E	63	TYR	2.1
4	F	343	TYR	2.1
2	D	397	PHE	2.1
1	A	128	GLN	2.1
2	B	54	ALA	2.1
2	D	176	SER	2.1
2	D	312	THR	2.1
2	D	321	MET	2.1
4	F	58	LEU	2.0
4	F	314	LEU	2.0
1	A	418	PHE	2.0
2	D	265	PHE	2.0
4	F	41	LEU	2.0
2	B	51	TYR	2.0
2	B	40	SER	2.0
2	B	56	GLY	2.0
2	D	71	GLY	2.0
2	D	96	GLY	2.0

6.2 Non-standard residues in protein, DNA, RNA chains [i](#)

There are no non-standard protein/DNA/RNA residues in this entry.

6.3 Carbohydrates [i](#)

There are no monosaccharides in this entry.

6.4 Ligands [i](#)

LIGAND-RSR INFOmissingINFO

6.5 Other polymers [i](#)

There are no such residues in this entry.