



Full wwPDB EM Validation Report ⓘ

Nov 13, 2022 – 12:42 AM EST

PDB ID : 6U23
EMDB ID : EMD-20616
Title : EM structure of MPEG-1(w.t.) soluble pre-pore
Authors : Pang, S.S.; Bayly-Jones, C.
Deposited on : 2019-08-19
Resolution : 3.49 Å(reported)

This is a Full wwPDB EM Validation Report for a publicly released PDB entry.

We welcome your comments at validation@mail.wwpdb.org

A user guide is available at

<https://www.wwpdb.org/validation/2017/EMValidationReportHelp>

with specific help available everywhere you see the ⓘ symbol.

The types of validation reports are described at

<http://www.wwpdb.org/validation/2017/FAQs#types>.

The following versions of software and data (see [references ⓘ](#)) were used in the production of this report:

EMDB validation analysis : 0.0.1.dev43
Mogul : 1.8.5 (274361), CSD as541be (2020)
MolProbity : 4.02b-467
Percentile statistics : 20191225.v01 (using entries in the PDB archive December 25th 2019)
MapQ : 1.9.9
Ideal geometry (proteins) : Engh & Huber (2001)
Ideal geometry (DNA, RNA) : Parkinson et al. (1996)
Validation Pipeline (wwPDB-VP) : 2.31.2

1 Overall quality at a glance

The following experimental techniques were used to determine the structure:

ELECTRON MICROSCOPY

The reported resolution of this entry is 3.49 Å.

Percentile scores (ranging between 0-100) for global validation metrics of the entry are shown in the following graphic. The table shows the number of entries on which the scores are based.

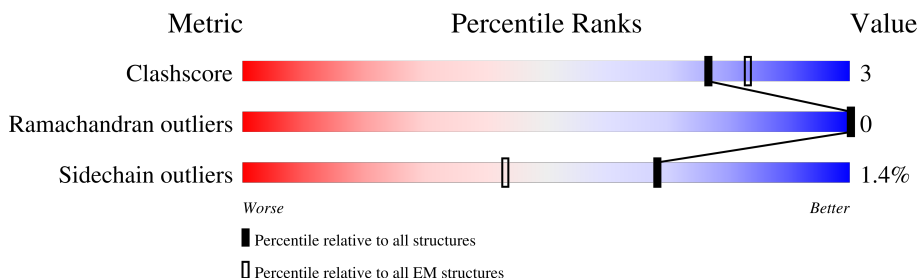

Metric	Whole archive (#Entries)	EM structures (#Entries)
Clashscore	158937	4297
Ramachandran outliers	154571	4023
Sidechain outliers	154315	3826

The table below summarises the geometric issues observed across the polymeric chains and their fit to the map. The red, orange, yellow and green segments of the bar indicate the fraction of residues that contain outliers for ≥ 3 , 2, 1 and 0 types of geometric quality criteria respectively. A grey segment represents the fraction of residues that are not modelled. The numeric value for each fraction is indicated below the corresponding segment, with a dot representing fractions $\leq 5\%$. The upper red bar (where present) indicates the fraction of residues that have poor fit to the EM map (all-atom inclusion $< 40\%$). The numeric value is given above the bar.

Mol	Chain	Length	Quality of chain
1	A	642	
1	B	642	
1	C	642	
1	D	642	
1	E	642	
1	F	642	
1	G	642	
1	H	642	

Continued on next page...

Continued from previous page...

Mol	Chain	Length	Quality of chain
1	I	642	
1	J	642	
1	K	642	
1	L	642	
1	M	642	
1	N	642	
1	O	642	
1	P	642	
2	Q	2	
2	R	2	
2	S	2	
2	T	2	
2	U	2	
2	V	2	
2	W	2	
2	X	2	
2	Y	2	
2	Z	2	
2	a	2	
2	b	2	
2	c	2	
2	d	2	
2	e	2	
2	f	2	
2	g	2	

Continued on next page...

Continued from previous page...

Mol	Chain	Length	Quality of chain
2	h	2	 50% 100%
2	i	2	 50% 100%
2	j	2	 50% 100%
2	k	2	 50% 100%
2	l	2	 50% 100%
2	m	2	 50% 100%
2	n	2	 50% 100%
2	o	2	 50% 100%
2	p	2	 50% 100%
2	q	2	 50% 100%
2	r	2	 50% 100%
2	s	2	 50% 100%
2	t	2	 50% 100%
2	u	2	 50% 100%
2	v	2	 50% 100%

2 Entry composition [i](#)

There are 2 unique types of molecules in this entry. The entry contains 73472 atoms, of which 0 are hydrogens and 0 are deuteriums.

In the tables below, the AltConf column contains the number of residues with at least one atom in alternate conformation and the Trace column contains the number of residues modelled with at most 2 atoms.

- Molecule 1 is a protein called Macrophage-expressed gene 1 protein.

Mol	Chain	Residues	Atoms					AltConf	Trace
			Total	C	N	O	S		
1	A	583	4536	2867	777	867	25	0	0
1	B	583	4536	2867	777	867	25	0	0
1	C	583	4536	2867	777	867	25	0	0
1	D	583	4536	2867	777	867	25	0	0
1	E	583	4536	2867	777	867	25	0	0
1	F	583	4536	2867	777	867	25	0	0
1	G	583	4536	2867	777	867	25	0	0
1	H	583	4536	2867	777	867	25	0	0
1	I	583	4536	2867	777	867	25	0	0
1	J	583	4536	2867	777	867	25	0	0
1	K	583	4536	2867	777	867	25	0	0
1	L	583	4536	2867	777	867	25	0	0
1	M	583	4536	2867	777	867	25	0	0
1	N	583	4536	2867	777	867	25	0	0
1	O	583	4536	2867	777	867	25	0	0
1	P	583	4536	2867	777	867	25	0	0

There are 96 discrepancies between the modelled and reference sequences:

Chain	Residue	Modelled	Actual	Comment	Reference
A	637	HIS	-	expression tag	UNP Q2M385
A	638	HIS	-	expression tag	UNP Q2M385
A	639	HIS	-	expression tag	UNP Q2M385
A	640	HIS	-	expression tag	UNP Q2M385
A	641	HIS	-	expression tag	UNP Q2M385
A	642	HIS	-	expression tag	UNP Q2M385
B	637	HIS	-	expression tag	UNP Q2M385
B	638	HIS	-	expression tag	UNP Q2M385
B	639	HIS	-	expression tag	UNP Q2M385
B	640	HIS	-	expression tag	UNP Q2M385
B	641	HIS	-	expression tag	UNP Q2M385
B	642	HIS	-	expression tag	UNP Q2M385
C	637	HIS	-	expression tag	UNP Q2M385
C	638	HIS	-	expression tag	UNP Q2M385
C	639	HIS	-	expression tag	UNP Q2M385
C	640	HIS	-	expression tag	UNP Q2M385
C	641	HIS	-	expression tag	UNP Q2M385
C	642	HIS	-	expression tag	UNP Q2M385
D	637	HIS	-	expression tag	UNP Q2M385
D	638	HIS	-	expression tag	UNP Q2M385
D	639	HIS	-	expression tag	UNP Q2M385
D	640	HIS	-	expression tag	UNP Q2M385
D	641	HIS	-	expression tag	UNP Q2M385
D	642	HIS	-	expression tag	UNP Q2M385
E	637	HIS	-	expression tag	UNP Q2M385
E	638	HIS	-	expression tag	UNP Q2M385
E	639	HIS	-	expression tag	UNP Q2M385
E	640	HIS	-	expression tag	UNP Q2M385
E	641	HIS	-	expression tag	UNP Q2M385
E	642	HIS	-	expression tag	UNP Q2M385
F	637	HIS	-	expression tag	UNP Q2M385
F	638	HIS	-	expression tag	UNP Q2M385
F	639	HIS	-	expression tag	UNP Q2M385
F	640	HIS	-	expression tag	UNP Q2M385
F	641	HIS	-	expression tag	UNP Q2M385
F	642	HIS	-	expression tag	UNP Q2M385
G	637	HIS	-	expression tag	UNP Q2M385
G	638	HIS	-	expression tag	UNP Q2M385
G	639	HIS	-	expression tag	UNP Q2M385
G	640	HIS	-	expression tag	UNP Q2M385
G	641	HIS	-	expression tag	UNP Q2M385
G	642	HIS	-	expression tag	UNP Q2M385
H	637	HIS	-	expression tag	UNP Q2M385

Continued on next page...

Continued from previous page...

Chain	Residue	Modelled	Actual	Comment	Reference
H	638	HIS	-	expression tag	UNP Q2M385
H	639	HIS	-	expression tag	UNP Q2M385
H	640	HIS	-	expression tag	UNP Q2M385
H	641	HIS	-	expression tag	UNP Q2M385
H	642	HIS	-	expression tag	UNP Q2M385
I	637	HIS	-	expression tag	UNP Q2M385
I	638	HIS	-	expression tag	UNP Q2M385
I	639	HIS	-	expression tag	UNP Q2M385
I	640	HIS	-	expression tag	UNP Q2M385
I	641	HIS	-	expression tag	UNP Q2M385
I	642	HIS	-	expression tag	UNP Q2M385
J	637	HIS	-	expression tag	UNP Q2M385
J	638	HIS	-	expression tag	UNP Q2M385
J	639	HIS	-	expression tag	UNP Q2M385
J	640	HIS	-	expression tag	UNP Q2M385
J	641	HIS	-	expression tag	UNP Q2M385
J	642	HIS	-	expression tag	UNP Q2M385
K	637	HIS	-	expression tag	UNP Q2M385
K	638	HIS	-	expression tag	UNP Q2M385
K	639	HIS	-	expression tag	UNP Q2M385
K	640	HIS	-	expression tag	UNP Q2M385
K	641	HIS	-	expression tag	UNP Q2M385
K	642	HIS	-	expression tag	UNP Q2M385
L	637	HIS	-	expression tag	UNP Q2M385
L	638	HIS	-	expression tag	UNP Q2M385
L	639	HIS	-	expression tag	UNP Q2M385
L	640	HIS	-	expression tag	UNP Q2M385
L	641	HIS	-	expression tag	UNP Q2M385
L	642	HIS	-	expression tag	UNP Q2M385
M	637	HIS	-	expression tag	UNP Q2M385
M	638	HIS	-	expression tag	UNP Q2M385
M	639	HIS	-	expression tag	UNP Q2M385
M	640	HIS	-	expression tag	UNP Q2M385
M	641	HIS	-	expression tag	UNP Q2M385
M	642	HIS	-	expression tag	UNP Q2M385
N	637	HIS	-	expression tag	UNP Q2M385
N	638	HIS	-	expression tag	UNP Q2M385
N	639	HIS	-	expression tag	UNP Q2M385
N	640	HIS	-	expression tag	UNP Q2M385
N	641	HIS	-	expression tag	UNP Q2M385
N	642	HIS	-	expression tag	UNP Q2M385
O	637	HIS	-	expression tag	UNP Q2M385

Continued on next page...

Continued from previous page...

Chain	Residue	Modelled	Actual	Comment	Reference
O	638	HIS	-	expression tag	UNP Q2M385
O	639	HIS	-	expression tag	UNP Q2M385
O	640	HIS	-	expression tag	UNP Q2M385
O	641	HIS	-	expression tag	UNP Q2M385
O	642	HIS	-	expression tag	UNP Q2M385
P	637	HIS	-	expression tag	UNP Q2M385
P	638	HIS	-	expression tag	UNP Q2M385
P	639	HIS	-	expression tag	UNP Q2M385
P	640	HIS	-	expression tag	UNP Q2M385
P	641	HIS	-	expression tag	UNP Q2M385
P	642	HIS	-	expression tag	UNP Q2M385

- Molecule 2 is an oligosaccharide called 2-acetamido-2-deoxy-beta-D-glucopyranose-(1-4)-2-acetamido-2-deoxy-beta-D-glucopyranose.



Mol	Chain	Residues	Atoms				AltConf	Trace
			Total	C	N	O		
2	Q	2	28	16	2	10	0	0
2	R	2	28	16	2	10	0	0
2	S	2	28	16	2	10	0	0
2	T	2	28	16	2	10	0	0
2	U	2	28	16	2	10	0	0
2	V	2	28	16	2	10	0	0
2	W	2	28	16	2	10	0	0
2	X	2	28	16	2	10	0	0
2	Y	2	28	16	2	10	0	0
2	Z	2	28	16	2	10	0	0
2	a	2	28	16	2	10	0	0

Continued on next page...

Continued from previous page...

Mol	Chain	Residues	Atoms				AltConf	Trace
			Total	C	N	O		
2	b	2	28	16	2	10	0	0
2	c	2	28	16	2	10	0	0
2	d	2	28	16	2	10	0	0
2	e	2	28	16	2	10	0	0
2	f	2	28	16	2	10	0	0
2	g	2	28	16	2	10	0	0
2	h	2	28	16	2	10	0	0
2	i	2	28	16	2	10	0	0
2	j	2	28	16	2	10	0	0
2	k	2	28	16	2	10	0	0
2	l	2	28	16	2	10	0	0
2	m	2	28	16	2	10	0	0
2	n	2	28	16	2	10	0	0
2	o	2	28	16	2	10	0	0
2	p	2	28	16	2	10	0	0
2	q	2	28	16	2	10	0	0
2	r	2	28	16	2	10	0	0
2	s	2	28	16	2	10	0	0
2	t	2	28	16	2	10	0	0
2	u	2	28	16	2	10	0	0
2	v	2	28	16	2	10	0	0



• Molecule 1: Macrophage-expressed gene 1 protein

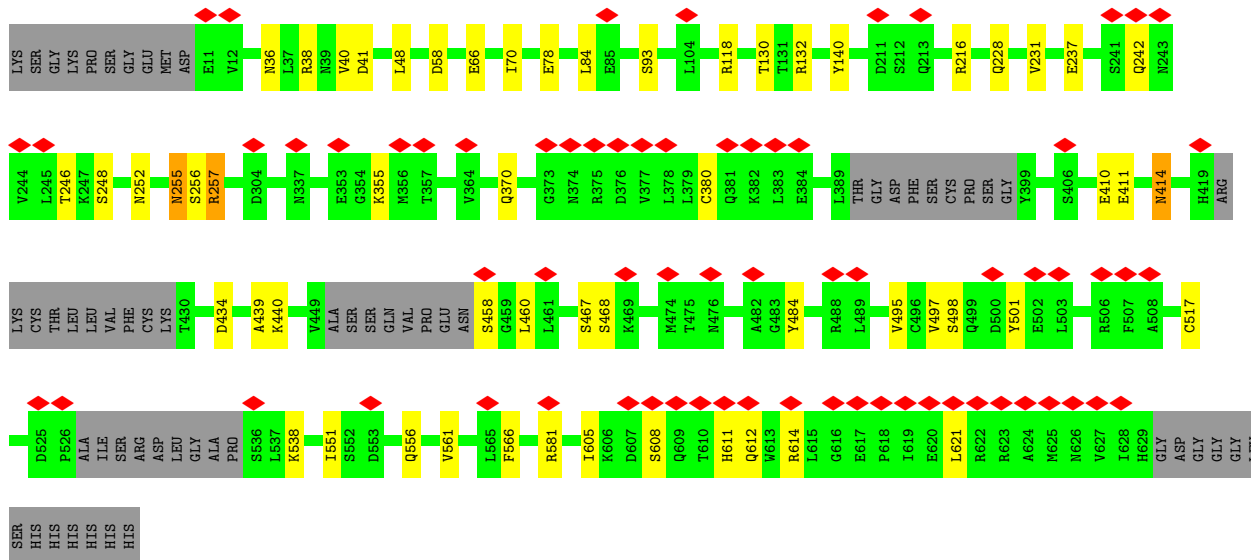
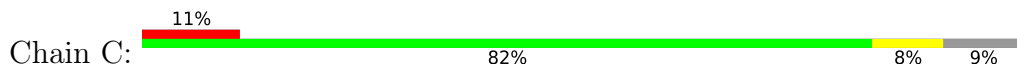

• Molecule 1: Macrophage-expressed gene 1 protein

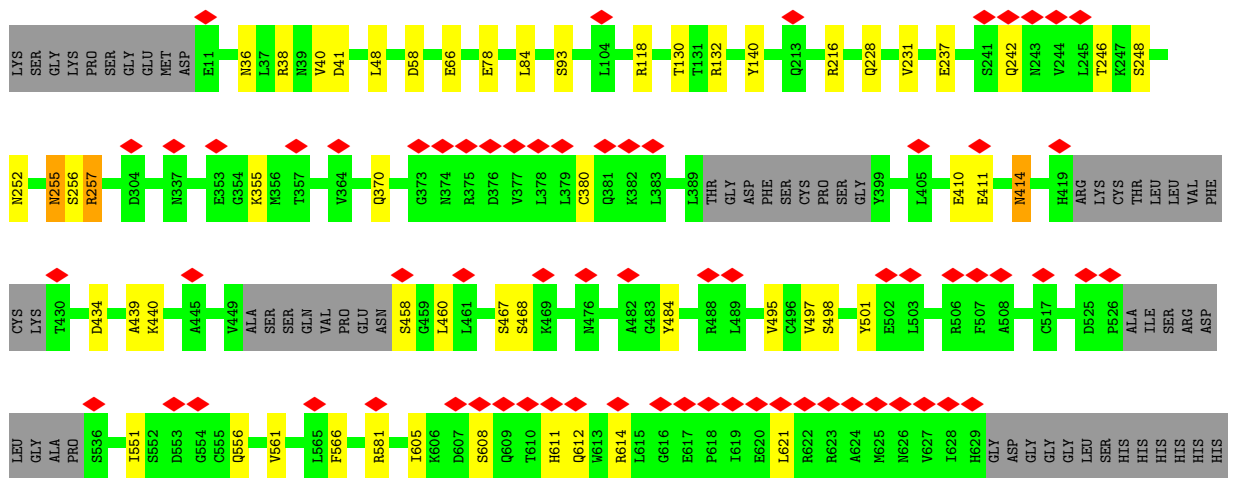
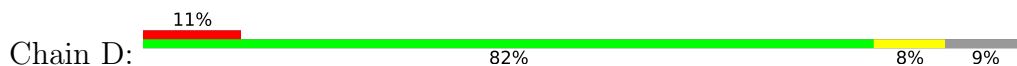

• Molecule 1: Macrophage-expressed gene 1 protein

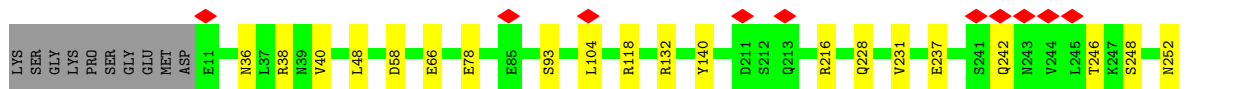
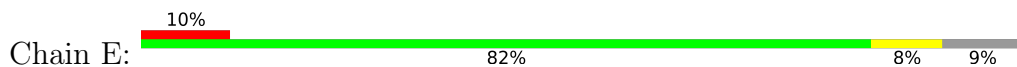

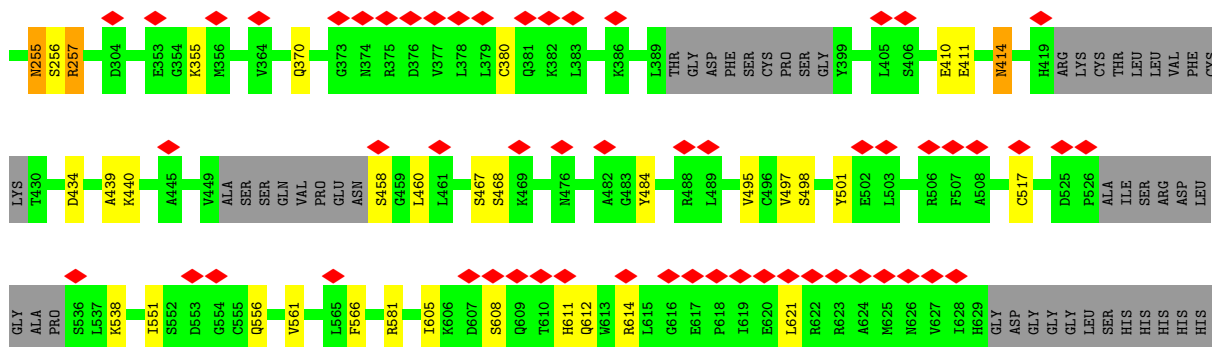

• Molecule 1: Macrophage-expressed gene 1 protein

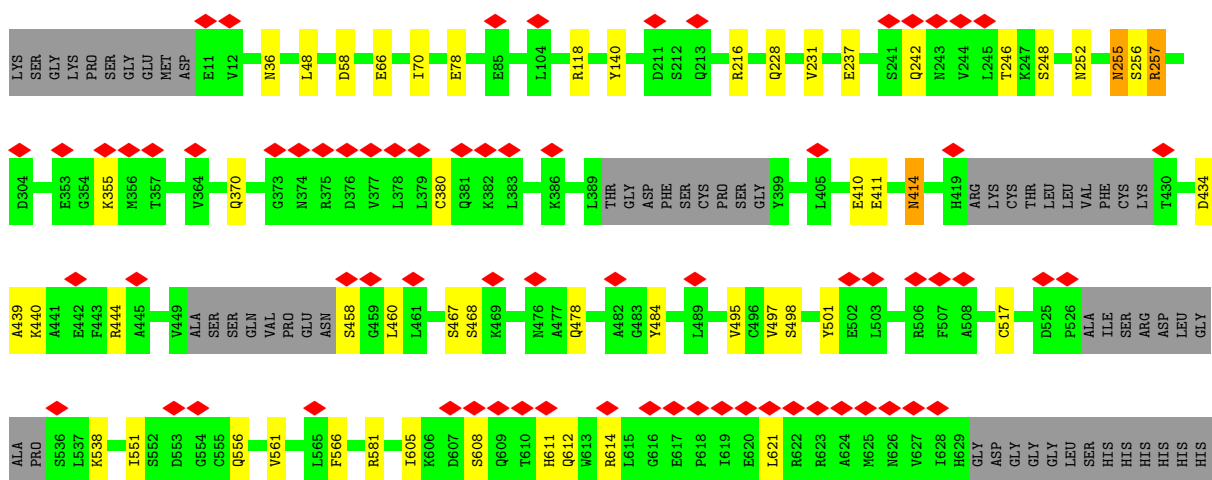
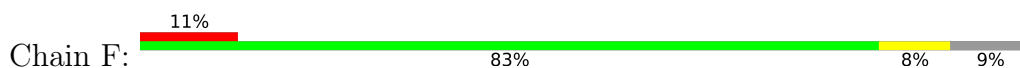

• Molecule 1: Macrophage-expressed gene 1 protein

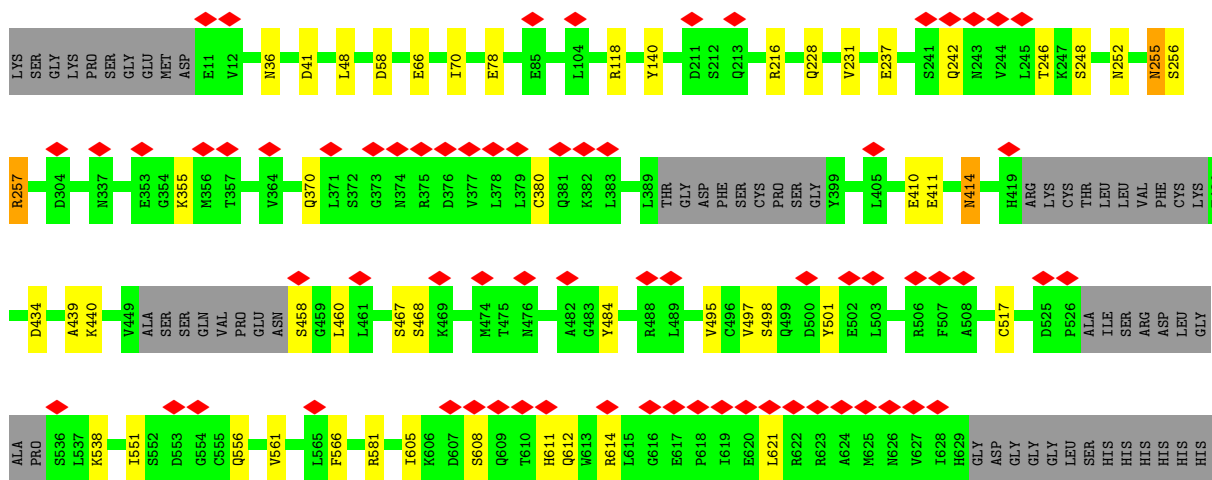
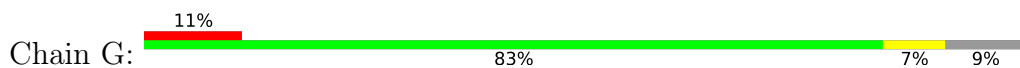

• Molecule 1: Macrophage-expressed gene 1 protein

HIS
HIS
HIS

• Molecule 1: Macrophage-expressed gene 1 protein

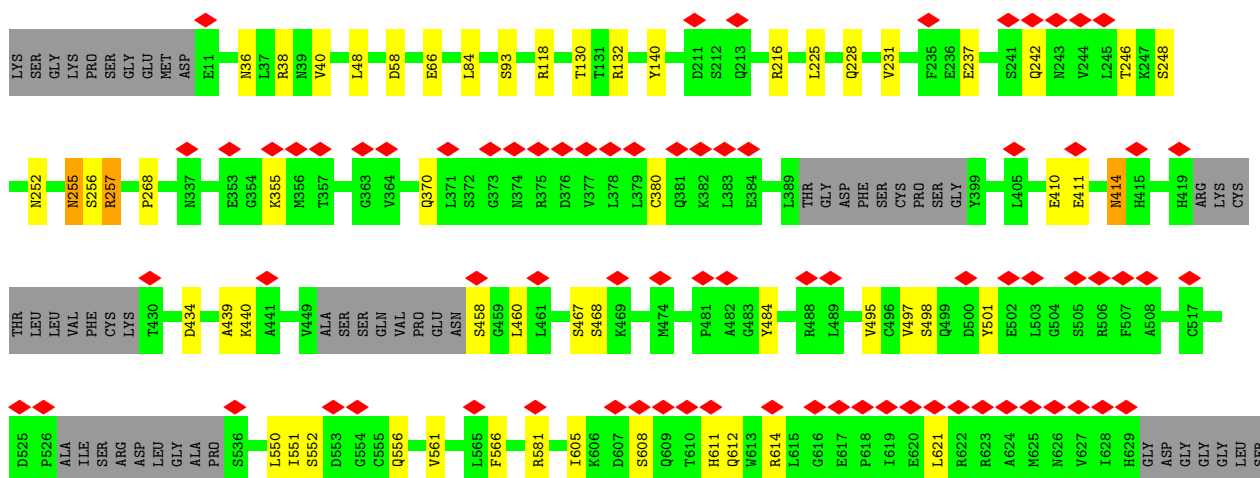
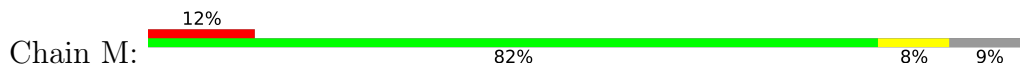

HIS
HIS
HIS
HIS
HIS
HIS

• Molecule 1: Macrophage-expressed gene 1 protein

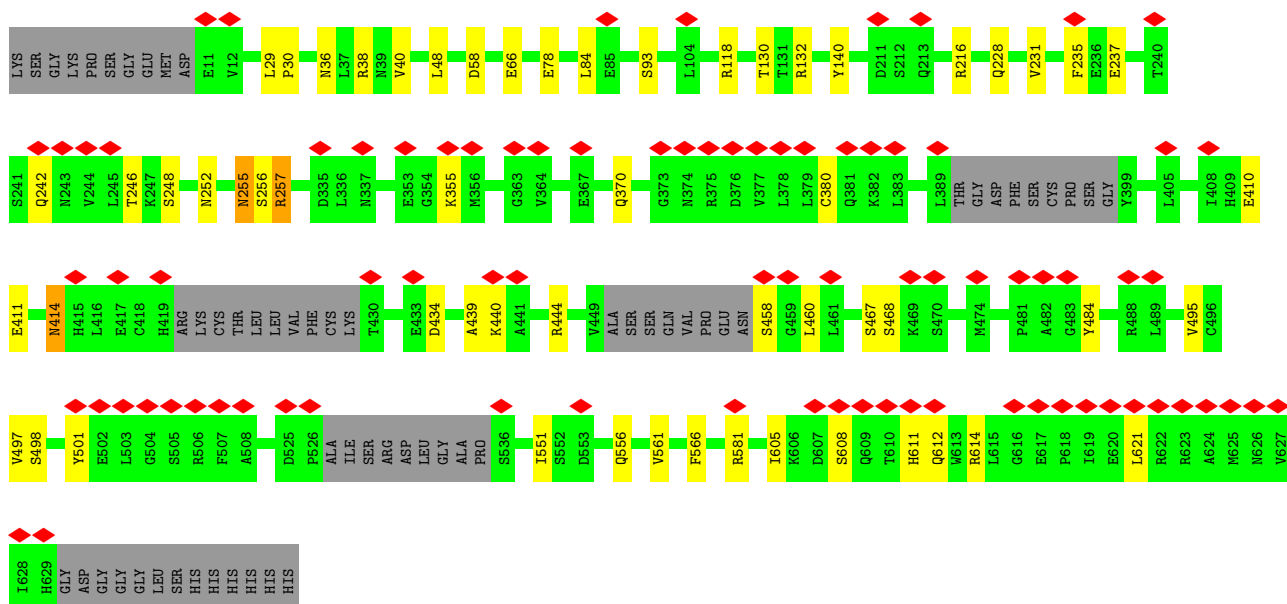
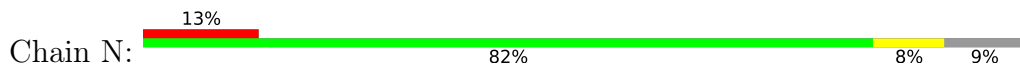

• Molecule 1: Macrophage-expressed gene 1 protein

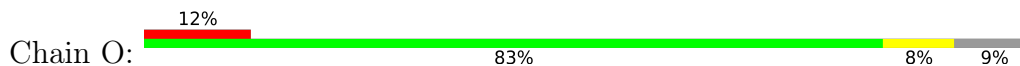

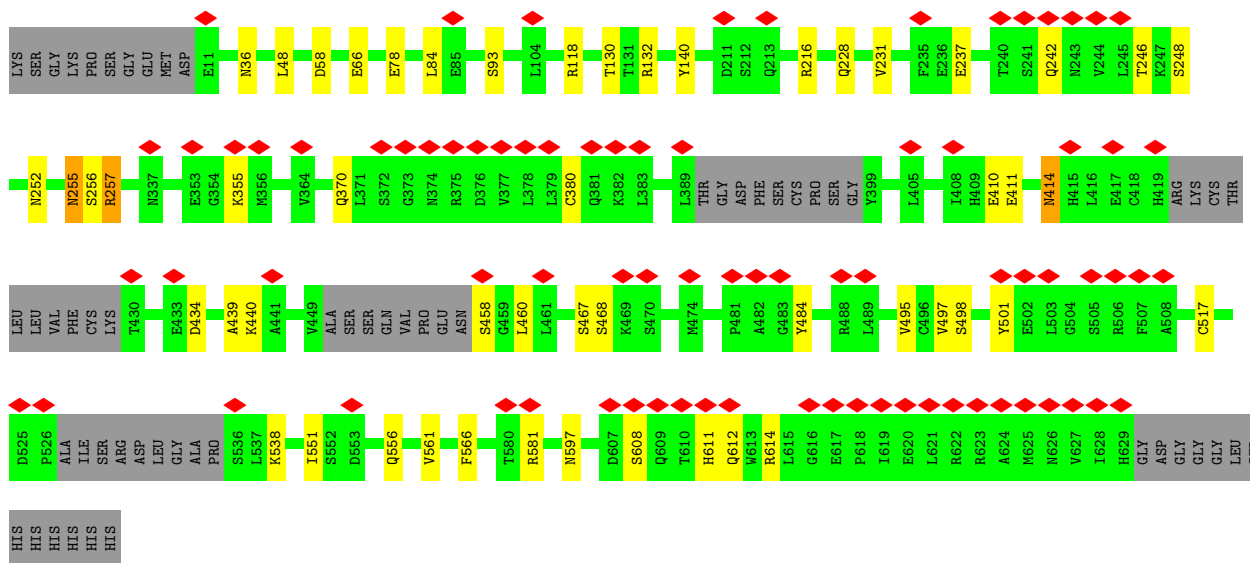

• Molecule 1: Macrophage-expressed gene 1 protein

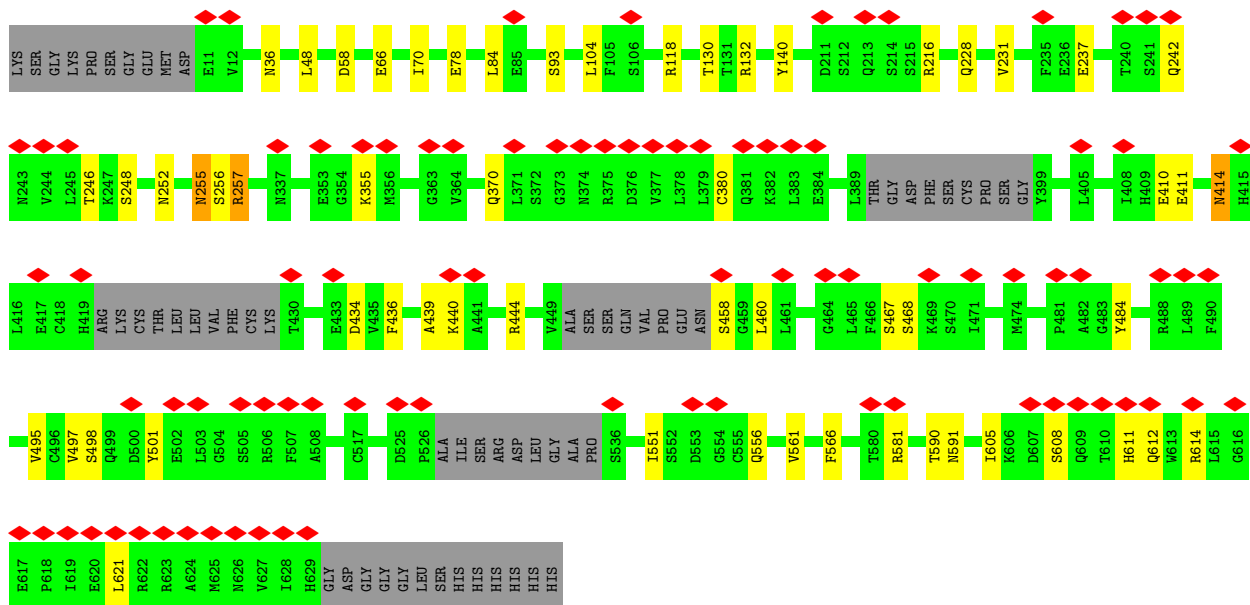
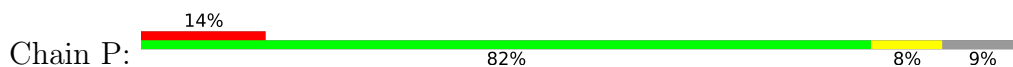

• Molecule 2: 2-acetamido-2-deoxy-beta-D-glucopyranose-(1-4)-2-acetamido-2-deoxy-beta-D-glucopyranose



• Molecule 2: 2-acetamido-2-deoxy-beta-D-glucopyranose-(1-4)-2-acetamido-2-deoxy-beta-D-glucopyranose



- Molecule 2: 2-acetamido-2-deoxy-beta-D-glucopyranose-(1-4)-2-acetamido-2-deoxy-beta-D-glucopyranose



- Molecule 2: 2-acetamido-2-deoxy-beta-D-glucopyranose-(1-4)-2-acetamido-2-deoxy-beta-D-glucopyranose



- Molecule 2: 2-acetamido-2-deoxy-beta-D-glucopyranose-(1-4)-2-acetamido-2-deoxy-beta-D-glucopyranose



- Molecule 2: 2-acetamido-2-deoxy-beta-D-glucopyranose-(1-4)-2-acetamido-2-deoxy-beta-D-glucopyranose



- Molecule 2: 2-acetamido-2-deoxy-beta-D-glucopyranose-(1-4)-2-acetamido-2-deoxy-beta-D-glucopyranose



- Molecule 2: 2-acetamido-2-deoxy-beta-D-glucopyranose-(1-4)-2-acetamido-2-deoxy-beta-D-glucopyranose



- Molecule 2: 2-acetamido-2-deoxy-beta-D-glucopyranose-(1-4)-2-acetamido-2-deoxy-beta-D-glucopyranose



- Molecule 2: 2-acetamido-2-deoxy-beta-D-glucopyranose-(1-4)-2-acetamido-2-deoxy-beta-D-glucopyranose



- Molecule 2: 2-acetamido-2-deoxy-beta-D-glucopyranose-(1-4)-2-acetamido-2-deoxy-beta-D-glucopyranose



- Molecule 2: 2-acetamido-2-deoxy-beta-D-glucopyranose-(1-4)-2-acetamido-2-deoxy-beta-D-glucopyranose



- Molecule 2: 2-acetamido-2-deoxy-beta-D-glucopyranose-(1-4)-2-acetamido-2-deoxy-beta-D-glucopyranose





- Molecule 2: 2-acetamido-2-deoxy-beta-D-glucopyranose-(1-4)-2-acetamido-2-deoxy-beta-D-glucopyranose



- Molecule 2: 2-acetamido-2-deoxy-beta-D-glucopyranose-(1-4)-2-acetamido-2-deoxy-beta-D-glucopyranose



- Molecule 2: 2-acetamido-2-deoxy-beta-D-glucopyranose-(1-4)-2-acetamido-2-deoxy-beta-D-glucopyranose



- Molecule 2: 2-acetamido-2-deoxy-beta-D-glucopyranose-(1-4)-2-acetamido-2-deoxy-beta-D-glucopyranose



- Molecule 2: 2-acetamido-2-deoxy-beta-D-glucopyranose-(1-4)-2-acetamido-2-deoxy-beta-D-glucopyranose



- Molecule 2: 2-acetamido-2-deoxy-beta-D-glucopyranose-(1-4)-2-acetamido-2-deoxy-beta-D-glucopyranose



- Molecule 2: 2-acetamido-2-deoxy-beta-D-glucopyranose-(1-4)-2-acetamido-2-deoxy-beta-D-glucopyranose



- Molecule 2: 2-acetamido-2-deoxy-beta-D-glucopyranose-(1-4)-2-acetamido-2-deoxy-beta-D-glucopyranose



- Molecule 2: 2-acetamido-2-deoxy-beta-D-glucopyranose-(1-4)-2-acetamido-2-deoxy-beta-D-glucopyranose



- Molecule 2: 2-acetamido-2-deoxy-beta-D-glucopyranose-(1-4)-2-acetamido-2-deoxy-beta-D-glucopyranose



- Molecule 2: 2-acetamido-2-deoxy-beta-D-glucopyranose-(1-4)-2-acetamido-2-deoxy-beta-D-glucopyranose



- Molecule 2: 2-acetamido-2-deoxy-beta-D-glucopyranose-(1-4)-2-acetamido-2-deoxy-beta-D-glucopyranose



- Molecule 2: 2-acetamido-2-deoxy-beta-D-glucopyranose-(1-4)-2-acetamido-2-deoxy-beta-D-glucopyranose



- Molecule 2: 2-acetamido-2-deoxy-beta-D-glucopyranose-(1-4)-2-acetamido-2-deoxy-beta-D-glucopyranose



- Molecule 2: 2-acetamido-2-deoxy-beta-D-glucopyranose-(1-4)-2-acetamido-2-deoxy-beta-D-glucopyranose



- Molecule 2: 2-acetamido-2-deoxy-beta-D-glucopyranose-(1-4)-2-acetamido-2-deoxy-beta-D-glucopyranose



- Molecule 2: 2-acetamido-2-deoxy-beta-D-glucopyranose-(1-4)-2-acetamido-2-deoxy-beta-D-glucopyranose





- Molecule 2: 2-acetamido-2-deoxy-beta-D-glucopyranose-(1-4)-2-acetamido-2-deoxy-beta-D-glucopyranose



- Molecule 2: 2-acetamido-2-deoxy-beta-D-glucopyranose-(1-4)-2-acetamido-2-deoxy-beta-D-glucopyranose



4 Experimental information

Property	Value	Source
EM reconstruction method	SINGLE PARTICLE	Depositor
Imposed symmetry	POINT, C16	Depositor
Number of particles used	25359	Depositor
Resolution determination method	FSC 0.143 CUT-OFF	Depositor
CTF correction method	PHASE FLIPPING AND AMPLITUDE CORRECTION	Depositor
Microscope	FEI TITAN KRIOS	Depositor
Voltage (kV)	300	Depositor
Electron dose ($e^-/\text{\AA}^2$)	45.0	Depositor
Minimum defocus (nm)	Not provided	
Maximum defocus (nm)	Not provided	
Magnification	Not provided	
Image detector	FEI FALCON II (4k x 4k)	Depositor
Maximum map value	6.978	Depositor
Minimum map value	-3.658	Depositor
Average map value	-0.001	Depositor
Map value standard deviation	0.186	Depositor
Recommended contour level	1.0	Depositor
Map size (Å)	440.0, 440.0, 440.0	wwPDB
Map dimensions	400, 400, 400	wwPDB
Map angles (°)	90.0, 90.0, 90.0	wwPDB
Pixel spacing (Å)	1.1, 1.1, 1.1	Depositor

5 Model quality

5.1 Standard geometry

Bond lengths and bond angles in the following residue types are not validated in this section: NAG

The Z score for a bond length (or angle) is the number of standard deviations the observed value is removed from the expected value. A bond length (or angle) with $|Z| > 5$ is considered an outlier worth inspection. RMSZ is the root-mean-square of all Z scores of the bond lengths (or angles).

Mol	Chain	Bond lengths		Bond angles	
		RMSZ	# Z >5	RMSZ	# Z >5
1	A	0.37	0/4634	0.57	0/6291
1	B	0.37	0/4634	0.57	0/6291
1	C	0.37	0/4634	0.57	0/6291
1	D	0.37	0/4634	0.57	0/6291
1	E	0.37	0/4634	0.57	0/6291
1	F	0.37	0/4634	0.57	0/6291
1	G	0.37	0/4634	0.57	0/6291
1	H	0.37	0/4634	0.57	0/6291
1	I	0.37	0/4634	0.57	0/6291
1	J	0.37	0/4634	0.57	0/6291
1	K	0.37	0/4634	0.57	0/6291
1	L	0.37	0/4634	0.57	0/6291
1	M	0.37	0/4634	0.57	0/6291
1	N	0.37	0/4634	0.57	0/6291
1	O	0.37	0/4634	0.57	0/6291
1	P	0.37	0/4634	0.57	0/6291
All	All	0.37	0/74144	0.57	0/100656

There are no bond length outliers.

There are no bond angle outliers.

There are no chirality outliers.

There are no planarity outliers.

5.2 Too-close contacts

In the following table, the Non-H and H(model) columns list the number of non-hydrogen atoms and hydrogen atoms in the chain respectively. The H(added) column lists the number of hydrogen atoms added and optimized by MolProbity. The Clashes column lists the number of clashes within the asymmetric unit, whereas Symm-Clashes lists symmetry-related clashes.

Mol	Chain	Non-H	H(model)	H(added)	Clashes	Symm-Clashes
1	A	4536	0	4416	34	0
1	B	4536	0	4416	29	0
1	C	4536	0	4416	31	0
1	D	4536	0	4416	29	0
1	E	4536	0	4416	29	0
1	F	4536	0	4416	28	0
1	G	4536	0	4416	28	0
1	H	4536	0	4416	27	0
1	I	4536	0	4416	27	0
1	J	4536	0	4416	28	0
1	K	4536	0	4416	30	0
1	L	4536	0	4416	29	0
1	M	4536	0	4416	29	0
1	N	4536	0	4416	29	0
1	O	4536	0	4416	28	0
1	P	4536	0	4416	32	0
2	Q	28	0	25	0	0
2	R	28	0	25	0	0
2	S	28	0	25	0	0
2	T	28	0	25	0	0
2	U	28	0	25	0	0
2	V	28	0	25	0	0
2	W	28	0	25	0	0
2	X	28	0	25	0	0
2	Y	28	0	25	0	0
2	Z	28	0	25	0	0
2	a	28	0	25	0	0
2	b	28	0	25	0	0
2	c	28	0	25	0	0
2	d	28	0	25	0	0
2	e	28	0	25	0	0
2	f	28	0	25	0	0
2	g	28	0	25	0	0
2	h	28	0	25	0	0
2	i	28	0	25	0	0
2	j	28	0	25	0	0
2	k	28	0	25	0	0
2	l	28	0	25	0	0
2	m	28	0	25	0	0
2	n	28	0	25	0	0
2	o	28	0	25	0	0
2	p	28	0	25	0	0
2	q	28	0	25	0	0

Continued on next page...

Continued from previous page...

Mol	Chain	Non-H	H(model)	H(added)	Clashes	Symm-Clashes
2	r	28	0	25	0	0
2	s	28	0	25	0	0
2	t	28	0	25	0	0
2	u	28	0	25	0	0
2	v	28	0	25	0	0
All	All	73472	0	71456	438	0

The all-atom clashscore is defined as the number of clashes found per 1000 atoms (including hydrogen atoms). The all-atom clashscore for this structure is 3.

All (438) close contacts within the same asymmetric unit are listed below, sorted by their clash magnitude.

Atom-1	Atom-2	Interatomic distance (Å)	Clash overlap (Å)
1:F:458:SER:N	1:F:501:TYR:HH	1.70	0.90
1:D:458:SER:N	1:D:501:TYR:HH	1.71	0.89
1:J:458:SER:N	1:J:501:TYR:HH	1.71	0.89
1:P:458:SER:N	1:P:501:TYR:HH	1.71	0.89
1:H:458:SER:N	1:H:501:TYR:HH	1.71	0.89
1:N:458:SER:N	1:N:501:TYR:HH	1.71	0.88
1:K:458:SER:N	1:K:501:TYR:HH	1.72	0.88
1:E:458:SER:N	1:E:501:TYR:HH	1.72	0.88
1:A:458:SER:N	1:A:501:TYR:HH	1.72	0.88
1:B:458:SER:N	1:B:501:TYR:HH	1.73	0.87
1:M:458:SER:N	1:M:501:TYR:HH	1.72	0.87
1:C:458:SER:N	1:C:501:TYR:HH	1.73	0.86
1:G:458:SER:N	1:G:501:TYR:HH	1.73	0.86
1:I:458:SER:N	1:I:501:TYR:HH	1.75	0.85
1:L:458:SER:N	1:L:501:TYR:HH	1.76	0.84
1:O:458:SER:N	1:O:501:TYR:HH	1.75	0.83
1:O:58:ASP:OD2	1:O:140:TYR:OH	2.11	0.68
1:H:58:ASP:OD2	1:H:140:TYR:OH	2.11	0.68
1:P:58:ASP:OD2	1:P:140:TYR:OH	2.11	0.68
1:A:58:ASP:OD2	1:A:140:TYR:OH	2.11	0.68
1:A:432:CYS:N	1:P:591:ASN:O	2.26	0.67
1:B:58:ASP:OD2	1:B:140:TYR:OH	2.11	0.67
1:I:58:ASP:OD2	1:I:140:TYR:OH	2.11	0.67
1:C:58:ASP:OD2	1:C:140:TYR:OH	2.11	0.66
1:J:58:ASP:OD2	1:J:140:TYR:OH	2.11	0.66
1:D:58:ASP:OD2	1:D:140:TYR:OH	2.11	0.65
1:K:58:ASP:OD2	1:K:140:TYR:OH	2.11	0.65
1:A:432:CYS:SG	1:P:590:THR:HB	2.36	0.65

Continued on next page...

Continued from previous page...

Atom-1	Atom-2	Interatomic distance (Å)	Clash overlap (Å)
1:L:58:ASP:OD2	1:L:140:TYR:OH	2.11	0.65
1:E:58:ASP:OD2	1:E:140:TYR:OH	2.11	0.64
1:A:78:GLU:OE2	1:B:255:ASN:ND2	2.30	0.64
1:G:58:ASP:OD2	1:G:140:TYR:OH	2.11	0.64
1:M:58:ASP:OD2	1:M:140:TYR:OH	2.11	0.63
1:F:58:ASP:OD2	1:F:140:TYR:OH	2.11	0.63
1:E:78:GLU:OE2	1:F:255:ASN:ND2	2.30	0.62
1:N:58:ASP:OD2	1:N:140:TYR:OH	2.11	0.62
1:P:612:GLN:HE22	1:P:614:ARG:HB3	1.64	0.62
1:A:612:GLN:HE22	1:A:614:ARG:HB3	1.64	0.62
1:N:612:GLN:HE22	1:N:614:ARG:HB3	1.64	0.62
1:L:612:GLN:HE22	1:L:614:ARG:HB3	1.64	0.62
1:O:612:GLN:HE22	1:O:614:ARG:HB3	1.64	0.62
1:A:478:GLN:NE2	1:P:104:LEU:O	2.33	0.61
1:F:612:GLN:HE22	1:F:614:ARG:HB3	1.64	0.61
1:C:612:GLN:HE22	1:C:614:ARG:HB3	1.64	0.61
1:H:612:GLN:HE22	1:H:614:ARG:HB3	1.64	0.61
1:D:78:GLU:OE2	1:E:255:ASN:ND2	2.33	0.61
1:J:612:GLN:HE22	1:J:614:ARG:HB3	1.64	0.61
1:K:612:GLN:HE22	1:K:614:ARG:HB3	1.64	0.61
1:M:612:GLN:HE22	1:M:614:ARG:HB3	1.64	0.61
1:E:612:GLN:HE22	1:E:614:ARG:HB3	1.64	0.61
1:G:612:GLN:HE22	1:G:614:ARG:HB3	1.64	0.61
1:B:612:GLN:HE22	1:B:614:ARG:HB3	1.64	0.60
1:P:414:ASN:HD21	1:P:434:ASP:HB2	1.67	0.60
1:A:414:ASN:HD21	1:A:434:ASP:HB2	1.67	0.60
1:N:414:ASN:HD21	1:N:434:ASP:HB2	1.67	0.60
1:O:414:ASN:HD21	1:O:434:ASP:HB2	1.67	0.60
1:B:414:ASN:HD21	1:B:434:ASP:HB2	1.67	0.60
1:I:414:ASN:HD21	1:I:434:ASP:HB2	1.67	0.60
1:H:414:ASN:HD21	1:H:434:ASP:HB2	1.67	0.60
1:M:414:ASN:HD21	1:M:434:ASP:HB2	1.67	0.60
1:C:414:ASN:HD21	1:C:434:ASP:HB2	1.67	0.60
1:F:78:GLU:OE2	1:G:255:ASN:ND2	2.33	0.60
1:I:612:GLN:HE22	1:I:614:ARG:HB3	1.64	0.60
1:L:414:ASN:HD21	1:L:434:ASP:HB2	1.67	0.60
1:D:414:ASN:HD21	1:D:434:ASP:HB2	1.67	0.60
1:D:612:GLN:HE22	1:D:614:ARG:HB3	1.64	0.60
1:J:414:ASN:HD21	1:J:434:ASP:HB2	1.67	0.59
1:B:78:GLU:OE2	1:C:255:ASN:ND2	2.33	0.59
1:E:414:ASN:HD21	1:E:434:ASP:HB2	1.66	0.59

Continued on next page...

Continued from previous page...

Atom-1	Atom-2	Interatomic distance (Å)	Clash overlap (Å)
1:J:78:GLU:OE2	1:K:255:ASN:ND2	2.34	0.59
1:G:414:ASN:HD21	1:G:434:ASP:HB2	1.67	0.59
1:K:414:ASN:HD21	1:K:434:ASP:HB2	1.67	0.59
1:F:414:ASN:HD21	1:F:434:ASP:HB2	1.67	0.58
1:G:78:GLU:OE2	1:H:255:ASN:ND2	2.36	0.58
1:C:78:GLU:OE2	1:D:255:ASN:ND2	2.36	0.57
1:A:255:ASN:ND2	1:P:78:GLU:OE2	2.37	0.57
1:I:78:GLU:OE2	1:J:255:ASN:ND2	2.37	0.56
1:O:78:GLU:OE2	1:P:255:ASN:ND2	2.38	0.55
1:B:70:ILE:HD13	1:C:41:ASP:OD1	2.08	0.54
1:K:78:GLU:OE2	1:L:255:ASN:ND2	2.38	0.54
1:F:70:ILE:HD13	1:G:41:ASP:OD1	2.07	0.53
1:H:608:SER:O	1:H:611:HIS:ND1	2.42	0.53
1:I:608:SER:O	1:I:611:HIS:ND1	2.42	0.53
1:J:608:SER:O	1:J:611:HIS:ND1	2.42	0.53
1:K:608:SER:O	1:K:611:HIS:ND1	2.42	0.53
1:G:608:SER:O	1:G:611:HIS:ND1	2.42	0.53
1:L:608:SER:O	1:L:611:HIS:ND1	2.42	0.52
1:F:608:SER:O	1:F:611:HIS:ND1	2.42	0.52
1:M:608:SER:O	1:M:611:HIS:ND1	2.42	0.52
1:B:608:SER:O	1:B:611:HIS:ND1	2.42	0.52
1:N:608:SER:O	1:N:611:HIS:ND1	2.42	0.52
1:E:608:SER:O	1:E:611:HIS:ND1	2.42	0.52
1:O:608:SER:O	1:O:611:HIS:ND1	2.42	0.51
1:D:608:SER:O	1:D:611:HIS:ND1	2.42	0.51
1:C:608:SER:O	1:C:611:HIS:ND1	2.42	0.51
1:P:608:SER:O	1:P:611:HIS:ND1	2.42	0.51
1:A:608:SER:O	1:A:611:HIS:ND1	2.42	0.51
1:O:411:GLU:O	1:O:439:ALA:N	2.43	0.51
1:P:411:GLU:O	1:P:439:ALA:N	2.43	0.51
1:N:411:GLU:O	1:N:439:ALA:N	2.43	0.50
1:J:370:GLN:HB2	1:J:380:CYS:HB2	1.94	0.50
1:M:411:GLU:O	1:M:439:ALA:N	2.43	0.50
1:O:370:GLN:HB2	1:O:380:CYS:HB2	1.94	0.50
1:K:370:GLN:HB2	1:K:380:CYS:HB2	1.94	0.50
1:L:411:GLU:O	1:L:439:ALA:N	2.43	0.50
1:N:370:GLN:HB2	1:N:380:CYS:HB2	1.94	0.50
1:C:370:GLN:HB2	1:C:380:CYS:HB2	1.94	0.50
1:P:370:GLN:HB2	1:P:380:CYS:HB2	1.94	0.50
1:B:370:GLN:HB2	1:B:380:CYS:HB2	1.94	0.50
1:D:370:GLN:HB2	1:D:380:CYS:HB2	1.94	0.50

Continued on next page...

Continued from previous page...

Atom-1	Atom-2	Interatomic distance (Å)	Clash overlap (Å)
1:L:370:GLN:HB2	1:L:380:CYS:HB2	1.94	0.50
1:A:370:GLN:HB2	1:A:380:CYS:HB2	1.94	0.50
1:G:370:GLN:HB2	1:G:380:CYS:HB2	1.94	0.50
1:H:370:GLN:HB2	1:H:380:CYS:HB2	1.94	0.50
1:I:370:GLN:HB2	1:I:380:CYS:HB2	1.94	0.50
1:M:370:GLN:HB2	1:M:380:CYS:HB2	1.94	0.50
1:E:370:GLN:HB2	1:E:380:CYS:HB2	1.94	0.49
1:F:370:GLN:HB2	1:F:380:CYS:HB2	1.94	0.49
1:C:248:SER:OG	1:C:252:ASN:OD1	2.30	0.49
1:E:248:SER:OG	1:E:252:ASN:OD1	2.30	0.49
1:N:248:SER:OG	1:N:252:ASN:OD1	2.30	0.49
1:G:248:SER:OG	1:G:252:ASN:OD1	2.30	0.49
1:K:411:GLU:O	1:K:439:ALA:N	2.43	0.49
1:E:561:VAL:HG21	1:E:566:PHE:HD2	1.78	0.49
1:L:248:SER:OG	1:L:252:ASN:OD1	2.30	0.49
1:P:248:SER:OG	1:P:252:ASN:OD1	2.30	0.49
1:F:561:VAL:HG21	1:F:566:PHE:HD2	1.78	0.49
1:D:248:SER:OG	1:D:252:ASN:OD1	2.30	0.49
1:J:561:VAL:HG21	1:J:566:PHE:HD2	1.78	0.49
1:M:248:SER:OG	1:M:252:ASN:OD1	2.30	0.49
1:H:561:VAL:HG21	1:H:566:PHE:HD2	1.78	0.49
1:I:561:VAL:HG21	1:I:566:PHE:HD2	1.78	0.49
1:J:248:SER:OG	1:J:252:ASN:OD1	2.30	0.49
1:D:561:VAL:HG21	1:D:566:PHE:HD2	1.78	0.48
1:B:561:VAL:HG21	1:B:566:PHE:HD2	1.78	0.48
1:H:248:SER:OG	1:H:252:ASN:OD1	2.30	0.48
1:I:248:SER:OG	1:I:252:ASN:OD1	2.30	0.48
1:J:411:GLU:O	1:J:439:ALA:N	2.43	0.48
1:F:248:SER:OG	1:F:252:ASN:OD1	2.30	0.48
1:G:561:VAL:HG21	1:G:566:PHE:HD2	1.78	0.48
1:A:411:GLU:O	1:A:439:ALA:N	2.43	0.48
1:K:561:VAL:HG21	1:K:566:PHE:HD2	1.78	0.48
1:A:561:VAL:HG21	1:A:566:PHE:HD2	1.78	0.48
1:P:561:VAL:HG21	1:P:566:PHE:HD2	1.78	0.48
1:B:411:GLU:O	1:B:439:ALA:N	2.43	0.48
1:N:561:VAL:HG21	1:N:566:PHE:HD2	1.78	0.48
1:E:48:LEU:HA	1:E:66:GLU:OE2	2.14	0.48
1:N:78:GLU:OE2	1:O:255:ASN:ND2	2.46	0.48
1:I:48:LEU:HA	1:I:66:GLU:OE2	2.14	0.47
1:A:48:LEU:HA	1:A:66:GLU:OE2	2.14	0.47
1:B:48:LEU:HA	1:B:66:GLU:OE2	2.14	0.47

Continued on next page...

Continued from previous page...

Atom-1	Atom-2	Interatomic distance (Å)	Clash overlap (Å)
1:C:561:VAL:HG21	1:C:566:PHE:HD2	1.78	0.47
1:H:48:LEU:HA	1:H:66:GLU:OE2	2.14	0.47
1:K:248:SER:OG	1:K:252:ASN:OD1	2.30	0.47
1:M:561:VAL:HG21	1:M:566:PHE:HD2	1.78	0.47
1:I:411:GLU:O	1:I:439:ALA:N	2.43	0.47
1:I:434:ASP:OD1	1:I:434:ASP:N	2.46	0.47
1:D:48:LEU:HA	1:D:66:GLU:OE2	2.14	0.47
1:F:48:LEU:HA	1:F:66:GLU:OE2	2.14	0.47
1:L:561:VAL:HG21	1:L:566:PHE:HD2	1.78	0.47
1:C:434:ASP:OD1	1:C:434:ASP:N	2.46	0.47
1:J:434:ASP:N	1:J:434:ASP:OD1	2.46	0.47
1:B:434:ASP:N	1:B:434:ASP:OD1	2.46	0.47
1:D:434:ASP:OD1	1:D:434:ASP:N	2.46	0.47
1:G:48:LEU:HA	1:G:66:GLU:OE2	2.14	0.47
1:K:434:ASP:OD1	1:K:434:ASP:N	2.46	0.47
1:L:434:ASP:N	1:L:434:ASP:OD1	2.46	0.47
1:P:434:ASP:OD1	1:P:434:ASP:N	2.46	0.47
1:A:434:ASP:OD1	1:A:434:ASP:N	2.46	0.47
1:E:434:ASP:N	1:E:434:ASP:OD1	2.46	0.47
1:O:561:VAL:HG21	1:O:566:PHE:HD2	1.78	0.47
1:M:48:LEU:HA	1:M:66:GLU:OE2	2.14	0.47
1:N:48:LEU:HA	1:N:66:GLU:OE2	2.14	0.47
1:C:48:LEU:HA	1:C:66:GLU:OE2	2.14	0.47
1:F:434:ASP:OD1	1:F:434:ASP:N	2.46	0.47
1:H:411:GLU:O	1:H:439:ALA:N	2.43	0.47
1:J:48:LEU:HA	1:J:66:GLU:OE2	2.14	0.47
1:K:48:LEU:HA	1:K:66:GLU:OE2	2.14	0.47
1:L:48:LEU:HA	1:L:66:GLU:OE2	2.14	0.47
1:O:434:ASP:OD1	1:O:434:ASP:N	2.46	0.47
1:C:237:GLU:OE2	1:C:242:GLN:NE2	2.49	0.46
1:K:517:CYS:O	1:K:538:LYS:NZ	2.46	0.46
1:N:434:ASP:OD1	1:N:434:ASP:N	2.46	0.46
1:P:48:LEU:HA	1:P:66:GLU:OE2	2.15	0.46
1:D:237:GLU:OE2	1:D:242:GLN:NE2	2.49	0.46
1:B:237:GLU:OE2	1:B:242:GLN:NE2	2.49	0.46
1:A:237:GLU:OE2	1:A:242:GLN:NE2	2.49	0.46
1:E:237:GLU:OE2	1:E:242:GLN:NE2	2.49	0.46
1:G:434:ASP:N	1:G:434:ASP:OD1	2.46	0.46
1:I:410:GLU:HG3	1:I:440:LYS:HG2	1.97	0.46
1:J:410:GLU:HG3	1:J:440:LYS:HG2	1.97	0.46
1:M:434:ASP:OD1	1:M:434:ASP:N	2.46	0.46

Continued on next page...

Continued from previous page...

Atom-1	Atom-2	Interatomic distance (Å)	Clash overlap (Å)
1:O:248:SER:OG	1:O:252:ASN:OD1	2.30	0.46
1:P:237:GLU:OE2	1:P:242:GLN:NE2	2.49	0.46
1:I:237:GLU:OE2	1:I:242:GLN:NE2	2.49	0.46
1:O:237:GLU:OE2	1:O:242:GLN:NE2	2.49	0.46
1:B:410:GLU:HG3	1:B:440:LYS:HG2	1.97	0.46
1:H:237:GLU:OE2	1:H:242:GLN:NE2	2.49	0.46
1:M:225:LEU:HD12	1:N:235:PHE:HZ	1.80	0.46
1:O:48:LEU:HA	1:O:66:GLU:OE2	2.14	0.46
1:H:434:ASP:OD1	1:H:434:ASP:N	2.46	0.46
1:J:70:ILE:HD13	1:K:41:ASP:OD1	2.16	0.46
1:J:237:GLU:OE2	1:J:242:GLN:NE2	2.49	0.46
1:K:410:GLU:HG3	1:K:440:LYS:HG2	1.97	0.46
1:N:237:GLU:OE2	1:N:242:GLN:NE2	2.49	0.46
1:A:517:CYS:O	1:A:538:LYS:NZ	2.46	0.46
1:H:410:GLU:HG3	1:H:440:LYS:HG2	1.97	0.46
1:K:104:LEU:O	1:L:478:GLN:NE2	2.49	0.46
1:P:410:GLU:HG3	1:P:440:LYS:HG2	1.97	0.46
1:D:411:GLU:O	1:D:439:ALA:N	2.43	0.46
1:G:411:GLU:O	1:G:439:ALA:N	2.43	0.46
1:M:237:GLU:OE2	1:M:242:GLN:NE2	2.49	0.46
1:F:237:GLU:OE2	1:F:242:GLN:NE2	2.49	0.45
1:G:410:GLU:HG3	1:G:440:LYS:HG2	1.97	0.45
1:J:517:CYS:O	1:J:538:LYS:NZ	2.46	0.45
1:L:410:GLU:HG3	1:L:440:LYS:HG2	1.97	0.45
1:O:410:GLU:HG3	1:O:440:LYS:HG2	1.97	0.45
1:G:237:GLU:OE2	1:G:242:GLN:NE2	2.49	0.45
1:K:255:ASN:HD22	1:K:256:SER:H	1.65	0.45
1:E:411:GLU:O	1:E:439:ALA:N	2.43	0.45
1:F:410:GLU:HG3	1:F:440:LYS:HG2	1.97	0.45
1:K:237:GLU:OE2	1:K:242:GLN:NE2	2.49	0.45
1:L:237:GLU:OE2	1:L:242:GLN:NE2	2.49	0.45
1:O:517:CYS:O	1:O:538:LYS:NZ	2.46	0.45
1:D:410:GLU:HG3	1:D:440:LYS:HG2	1.97	0.45
1:J:255:ASN:HD22	1:J:256:SER:H	1.65	0.45
1:L:255:ASN:HD22	1:L:256:SER:H	1.65	0.45
1:M:410:GLU:HG3	1:M:440:LYS:HG2	1.97	0.45
1:N:228:GLN:HA	1:N:231:VAL:HG12	1.98	0.45
1:C:517:CYS:O	1:C:538:LYS:NZ	2.46	0.45
1:F:228:GLN:HA	1:F:231:VAL:HG12	1.98	0.45
1:A:248:SER:OG	1:A:252:ASN:OD1	2.30	0.45
1:E:228:GLN:HA	1:E:231:VAL:HG12	1.98	0.45

Continued on next page...

Continued from previous page...

Atom-1	Atom-2	Interatomic distance (Å)	Clash overlap (Å)
1:E:551:ILE:HG12	1:E:556:GLN:HB3	1.99	0.45
1:J:551:ILE:HG12	1:J:556:GLN:HB3	1.99	0.45
1:I:255:ASN:HD22	1:I:256:SER:H	1.65	0.45
1:I:551:ILE:HG12	1:I:556:GLN:HB3	1.99	0.45
1:K:228:GLN:HA	1:K:231:VAL:HG12	1.98	0.45
1:L:228:GLN:HA	1:L:231:VAL:HG12	1.98	0.45
1:M:255:ASN:HD22	1:M:256:SER:H	1.65	0.45
1:M:484:TYR:HA	1:M:498:SER:HB2	1.99	0.45
1:O:228:GLN:HA	1:O:231:VAL:HG12	1.99	0.45
1:A:410:GLU:HG3	1:A:440:LYS:HG2	1.97	0.45
1:B:551:ILE:HG12	1:B:556:GLN:HB3	1.99	0.45
1:C:411:GLU:O	1:C:439:ALA:N	2.43	0.45
1:C:484:TYR:HA	1:C:498:SER:HB2	1.99	0.45
1:E:410:GLU:HG3	1:E:440:LYS:HG2	1.97	0.45
1:P:484:TYR:HA	1:P:498:SER:HB2	1.99	0.45
1:A:551:ILE:HG12	1:A:556:GLN:HB3	1.99	0.45
1:B:248:SER:OG	1:B:252:ASN:OD1	2.30	0.45
1:F:411:GLU:O	1:F:439:ALA:N	2.43	0.45
1:F:551:ILE:HG12	1:F:556:GLN:HB3	1.99	0.45
1:G:228:GLN:HA	1:G:231:VAL:HG12	1.98	0.45
1:M:551:ILE:HG12	1:M:556:GLN:HB3	1.99	0.45
1:N:551:ILE:HG12	1:N:556:GLN:HB3	1.99	0.45
1:C:410:GLU:HG3	1:C:440:LYS:HG2	1.97	0.44
1:D:551:ILE:HG12	1:D:556:GLN:HB3	1.99	0.44
1:K:551:ILE:HG12	1:K:556:GLN:HB3	1.99	0.44
1:N:255:ASN:HD22	1:N:256:SER:H	1.65	0.44
1:A:228:GLN:HA	1:A:231:VAL:HG12	1.98	0.44
1:A:484:TYR:HA	1:A:498:SER:HB2	1.99	0.44
1:D:228:GLN:HA	1:D:231:VAL:HG12	1.98	0.44
1:I:517:CYS:O	1:I:538:LYS:NZ	2.46	0.44
1:K:484:TYR:HA	1:K:498:SER:HB2	1.99	0.44
1:N:410:GLU:HG3	1:N:440:LYS:HG2	1.97	0.44
1:N:484:TYR:HA	1:N:498:SER:HB2	1.99	0.44
1:F:484:TYR:HA	1:F:498:SER:HB2	1.99	0.44
1:O:495:VAL:HG12	1:O:497:VAL:HG23	2.00	0.44
1:D:484:TYR:HA	1:D:498:SER:HB2	1.99	0.44
1:E:495:VAL:HG12	1:E:497:VAL:HG23	2.00	0.44
1:G:255:ASN:HD22	1:G:256:SER:H	1.65	0.44
1:H:484:TYR:HA	1:H:498:SER:HB2	1.99	0.44
1:H:495:VAL:HG12	1:H:497:VAL:HG23	2.00	0.44
1:H:517:CYS:O	1:H:538:LYS:NZ	2.46	0.44

Continued on next page...

Continued from previous page...

Atom-1	Atom-2	Interatomic distance (Å)	Clash overlap (Å)
1:J:484:TYR:HA	1:J:498:SER:HB2	1.99	0.44
1:H:255:ASN:HD22	1:H:256:SER:H	1.65	0.44
1:I:228:GLN:HA	1:I:231:VAL:HG12	1.98	0.44
1:M:228:GLN:HA	1:M:231:VAL:HG12	1.98	0.44
1:O:255:ASN:HD22	1:O:256:SER:H	1.65	0.44
1:P:255:ASN:HD22	1:P:256:SER:H	1.65	0.44
1:B:495:VAL:HG12	1:B:497:VAL:HG23	2.00	0.44
1:H:228:GLN:HA	1:H:231:VAL:HG12	1.98	0.44
1:H:551:ILE:HG12	1:H:556:GLN:HB3	1.99	0.44
1:O:484:TYR:HA	1:O:498:SER:HB2	1.99	0.44
1:O:551:ILE:HG12	1:O:556:GLN:HB3	1.99	0.44
1:C:551:ILE:HG12	1:C:556:GLN:HB3	1.99	0.44
1:E:484:TYR:HA	1:E:498:SER:HB2	1.99	0.44
1:E:517:CYS:O	1:E:538:LYS:NZ	2.46	0.44
1:J:495:VAL:HG12	1:J:497:VAL:HG23	2.00	0.44
1:M:495:VAL:HG12	1:M:497:VAL:HG23	2.00	0.44
1:B:228:GLN:HA	1:B:231:VAL:HG12	1.98	0.44
1:C:228:GLN:HA	1:C:231:VAL:HG12	1.99	0.44
1:G:517:CYS:O	1:G:538:LYS:NZ	2.46	0.44
1:G:551:ILE:HG12	1:G:556:GLN:HB3	1.99	0.44
1:L:484:TYR:HA	1:L:498:SER:HB2	1.99	0.44
1:L:551:ILE:HG12	1:L:556:GLN:HB3	1.99	0.44
1:P:551:ILE:HG12	1:P:556:GLN:HB3	1.99	0.44
1:F:255:ASN:HD22	1:F:256:SER:H	1.65	0.43
1:F:495:VAL:HG12	1:F:497:VAL:HG23	2.00	0.43
1:H:78:GLU:OE2	1:I:255:ASN:ND2	2.51	0.43
1:B:484:TYR:HA	1:B:498:SER:HB2	1.99	0.43
1:C:255:ASN:HD22	1:C:256:SER:H	1.65	0.43
1:E:255:ASN:HD22	1:E:256:SER:H	1.65	0.43
1:J:228:GLN:HA	1:J:231:VAL:HG12	1.98	0.43
1:L:495:VAL:HG12	1:L:497:VAL:HG23	2.00	0.43
1:P:228:GLN:HA	1:P:231:VAL:HG12	1.98	0.43
1:A:255:ASN:HD22	1:A:256:SER:H	1.65	0.43
1:B:255:ASN:HD22	1:B:256:SER:H	1.65	0.43
1:D:255:ASN:HD22	1:D:256:SER:H	1.65	0.43
1:G:495:VAL:HG12	1:G:497:VAL:HG23	2.00	0.43
1:P:495:VAL:HG12	1:P:497:VAL:HG23	2.00	0.43
1:A:41:ASP:OD1	1:P:70:ILE:HD13	2.18	0.43
1:A:495:VAL:HG12	1:A:497:VAL:HG23	2.00	0.43
1:C:495:VAL:HG12	1:C:497:VAL:HG23	2.00	0.43
1:F:517:CYS:O	1:F:538:LYS:NZ	2.46	0.43

Continued on next page...

Continued from previous page...

Atom-1	Atom-2	Interatomic distance (Å)	Clash overlap (Å)
1:I:484:TYR:HA	1:I:498:SER:HB2	1.99	0.43
1:K:495:VAL:HG12	1:K:497:VAL:HG23	2.00	0.43
1:D:495:VAL:HG12	1:D:497:VAL:HG23	2.00	0.43
1:E:104:LEU:O	1:F:478:GLN:NE2	2.52	0.43
1:I:495:VAL:HG12	1:I:497:VAL:HG23	2.00	0.43
1:N:495:VAL:HG12	1:N:497:VAL:HG23	2.00	0.43
1:A:104:LEU:O	1:B:478:GLN:NE2	2.52	0.43
1:A:467:SER:OG	1:A:468:SER:N	2.52	0.42
1:B:467:SER:OG	1:B:468:SER:N	2.52	0.42
1:G:484:TYR:HA	1:G:498:SER:HB2	1.99	0.42
1:O:597:ASN:HA	1:P:436:PHE:H	1.84	0.42
1:I:467:SER:OG	1:I:468:SER:N	2.53	0.42
1:P:467:SER:OG	1:P:468:SER:N	2.53	0.42
1:C:467:SER:OG	1:C:468:SER:N	2.52	0.42
1:H:467:SER:OG	1:H:468:SER:N	2.53	0.42
1:J:467:SER:OG	1:J:468:SER:N	2.53	0.42
1:H:460:LEU:HD13	1:H:497:VAL:HG11	2.02	0.42
1:J:460:LEU:HD13	1:J:497:VAL:HG11	2.01	0.42
1:O:467:SER:OG	1:O:468:SER:N	2.53	0.42
1:G:460:LEU:HD13	1:G:497:VAL:HG11	2.02	0.42
1:I:118:ARG:HH11	1:I:257:ARG:HH12	1.68	0.42
1:J:118:ARG:HH11	1:J:257:ARG:HH12	1.68	0.42
1:K:118:ARG:HH11	1:K:257:ARG:HH12	1.68	0.42
1:G:467:SER:OG	1:G:468:SER:N	2.52	0.42
1:I:460:LEU:HD13	1:I:497:VAL:HG11	2.02	0.42
1:K:467:SER:OG	1:K:468:SER:N	2.52	0.42
1:L:118:ARG:HH11	1:L:257:ARG:HH12	1.68	0.42
1:E:460:LEU:HD13	1:E:497:VAL:HG11	2.02	0.42
1:F:460:LEU:HD13	1:F:497:VAL:HG11	2.02	0.42
1:N:467:SER:OG	1:N:468:SER:N	2.52	0.42
1:F:605:ILE:HD11	1:F:621:LEU:HB3	2.02	0.42
1:H:605:ILE:HD11	1:H:621:LEU:HB3	2.02	0.42
1:L:77:LEU:HD21	1:M:268:PRO:HG3	2.02	0.42
1:D:467:SER:OG	1:D:468:SER:N	2.53	0.42
1:I:605:ILE:HD11	1:I:621:LEU:HB3	2.02	0.42
1:E:605:ILE:HD11	1:E:621:LEU:HB3	2.02	0.41
1:G:70:ILE:HD13	1:H:41:ASP:OD1	2.20	0.41
1:G:605:ILE:HD11	1:G:621:LEU:HB3	2.02	0.41
1:H:118:ARG:HH11	1:H:257:ARG:HH12	1.68	0.41
1:K:460:LEU:HD13	1:K:497:VAL:HG11	2.01	0.41
1:L:467:SER:OG	1:L:468:SER:N	2.52	0.41

Continued on next page...

Continued from previous page...

Atom-1	Atom-2	Interatomic distance (Å)	Clash overlap (Å)
1:M:84:LEU:HG	1:M:130:THR:HG23	2.02	0.41
1:M:467:SER:OG	1:M:468:SER:N	2.52	0.41
1:O:460:LEU:HD13	1:O:497:VAL:HG11	2.01	0.41
1:J:605:ILE:HD11	1:J:621:LEU:HB3	2.02	0.41
1:M:118:ARG:HH11	1:M:257:ARG:HH12	1.68	0.41
1:A:84:LEU:HG	1:A:130:THR:HG23	2.02	0.41
1:F:467:SER:OG	1:F:468:SER:N	2.53	0.41
1:L:84:LEU:HG	1:L:130:THR:HG23	2.03	0.41
1:P:84:LEU:HG	1:P:130:THR:HG23	2.03	0.41
1:C:605:ILE:HD11	1:C:621:LEU:HB3	2.02	0.41
1:D:460:LEU:HD13	1:D:497:VAL:HG11	2.02	0.41
1:K:605:ILE:HD11	1:K:621:LEU:HB3	2.02	0.41
1:F:118:ARG:HH11	1:F:257:ARG:HH12	1.68	0.41
1:G:118:ARG:HH11	1:G:257:ARG:HH12	1.68	0.41
1:K:84:LEU:HG	1:K:130:THR:HG23	2.03	0.41
1:N:84:LEU:HG	1:N:130:THR:HG23	2.02	0.41
1:N:118:ARG:HH11	1:N:257:ARG:HH12	1.68	0.41
1:N:460:LEU:HD13	1:N:497:VAL:HG11	2.01	0.41
1:O:84:LEU:HG	1:O:130:THR:HG23	2.03	0.41
1:D:605:ILE:HD11	1:D:621:LEU:HB3	2.02	0.41
1:E:118:ARG:HH11	1:E:257:ARG:HH12	1.68	0.41
1:A:89:ASN:OD1	1:A:89:ASN:N	2.53	0.41
1:C:460:LEU:HD13	1:C:497:VAL:HG11	2.02	0.41
1:E:467:SER:OG	1:E:468:SER:N	2.53	0.41
1:L:460:LEU:HD13	1:L:497:VAL:HG11	2.02	0.41
1:P:460:LEU:HD13	1:P:497:VAL:HG11	2.02	0.41
1:B:605:ILE:HD11	1:B:621:LEU:HB3	2.02	0.41
1:D:118:ARG:HH11	1:D:257:ARG:HH12	1.68	0.41
1:J:84:LEU:HG	1:J:130:THR:HG23	2.03	0.41
1:O:118:ARG:HH11	1:O:257:ARG:HH12	1.68	0.41
1:A:118:ARG:HH11	1:A:257:ARG:HH12	1.68	0.41
1:B:84:LEU:HG	1:B:130:THR:HG23	2.03	0.41
1:B:460:LEU:HD13	1:B:497:VAL:HG11	2.02	0.41
1:C:84:LEU:HG	1:C:130:THR:HG23	2.02	0.41
1:C:118:ARG:HH11	1:C:257:ARG:HH12	1.68	0.41
1:L:605:ILE:HD11	1:L:621:LEU:HB3	2.02	0.41
1:M:460:LEU:HD13	1:M:497:VAL:HG11	2.02	0.41
1:P:118:ARG:HH11	1:P:257:ARG:HH12	1.68	0.41
1:A:93:SER:HB3	1:A:132:ARG:NH1	2.36	0.41
1:A:242:GLN:HA	1:A:246:THR:HB	2.03	0.41
1:B:242:GLN:HA	1:B:246:THR:HB	2.03	0.41

Continued on next page...

Continued from previous page...

Atom-1	Atom-2	Interatomic distance (Å)	Clash overlap (Å)
1:C:93:SER:HB3	1:C:132:ARG:NH1	2.36	0.41
1:M:605:ILE:HD11	1:M:621:LEU:HB3	2.02	0.41
1:P:93:SER:HB3	1:P:132:ARG:NH1	2.36	0.41
1:A:605:ILE:HD11	1:A:621:LEU:HB3	2.02	0.40
1:B:93:SER:HB3	1:B:132:ARG:NH1	2.36	0.40
1:B:118:ARG:HH11	1:B:257:ARG:HH12	1.68	0.40
1:L:93:SER:HB3	1:L:132:ARG:NH1	2.36	0.40
1:L:242:GLN:HA	1:L:246:THR:HB	2.03	0.40
1:M:242:GLN:HA	1:M:246:THR:HB	2.03	0.40
1:O:242:GLN:HA	1:O:246:THR:HB	2.03	0.40
1:C:70:ILE:HD13	1:D:41:ASP:OD1	2.20	0.40
1:I:84:LEU:HG	1:I:130:THR:HG23	2.03	0.40
1:K:242:GLN:HA	1:K:246:THR:HB	2.03	0.40
1:M:93:SER:HB3	1:M:132:ARG:NH1	2.36	0.40
1:N:93:SER:HB3	1:N:132:ARG:NH1	2.36	0.40
1:P:242:GLN:HA	1:P:246:THR:HB	2.04	0.40
1:C:242:GLN:HA	1:C:246:THR:HB	2.04	0.40
1:D:38:ARG:O	1:D:40:VAL:N	2.54	0.40
1:D:84:LEU:HG	1:D:130:THR:HG23	2.02	0.40
1:D:242:GLN:HA	1:D:246:THR:HB	2.03	0.40
1:I:93:SER:HB3	1:I:132:ARG:NH1	2.36	0.40
1:N:605:ILE:HD11	1:N:621:LEU:HB3	2.02	0.40
1:P:605:ILE:HD11	1:P:621:LEU:HB3	2.02	0.40
1:C:38:ARG:O	1:C:40:VAL:N	2.54	0.40
1:F:242:GLN:HA	1:F:246:THR:HB	2.03	0.40
1:H:84:LEU:HG	1:H:130:THR:HG23	2.02	0.40
1:K:93:SER:HB3	1:K:132:ARG:NH1	2.36	0.40
1:M:550:LEU:HD13	1:M:552:SER:HB3	2.04	0.40
1:N:29:LEU:HA	1:N:30:PRO:HD3	1.97	0.40
1:N:38:ARG:O	1:N:40:VAL:N	2.54	0.40
1:O:93:SER:HB3	1:O:132:ARG:NH1	2.36	0.40
1:A:460:LEU:HD13	1:A:497:VAL:HG11	2.02	0.40
1:D:93:SER:HB3	1:D:132:ARG:NH1	2.36	0.40
1:E:38:ARG:O	1:E:40:VAL:N	2.54	0.40
1:E:93:SER:HB3	1:E:132:ARG:NH1	2.36	0.40
1:E:242:GLN:HA	1:E:246:THR:HB	2.03	0.40
1:G:242:GLN:HA	1:G:246:THR:HB	2.03	0.40
1:J:242:GLN:HA	1:J:246:THR:HB	2.03	0.40
1:L:550:LEU:HD13	1:L:552:SER:HB3	2.04	0.40
1:M:38:ARG:O	1:M:40:VAL:N	2.54	0.40
1:N:242:GLN:HA	1:N:246:THR:HB	2.03	0.40

There are no symmetry-related clashes.

5.3 Torsion angles [i](#)

5.3.1 Protein backbone [i](#)

In the following table, the Percentiles column shows the percent Ramachandran outliers of the chain as a percentile score with respect to all PDB entries followed by that with respect to all EM entries.

The Analysed column shows the number of residues for which the backbone conformation was analysed, and the total number of residues.

Mol	Chain	Analysed	Favoured	Allowed	Outliers	Percentiles	
1	A	573/642 (89%)	531 (93%)	42 (7%)	0	100	100
1	B	573/642 (89%)	531 (93%)	42 (7%)	0	100	100
1	C	573/642 (89%)	531 (93%)	42 (7%)	0	100	100
1	D	573/642 (89%)	531 (93%)	42 (7%)	0	100	100
1	E	573/642 (89%)	531 (93%)	42 (7%)	0	100	100
1	F	573/642 (89%)	531 (93%)	42 (7%)	0	100	100
1	G	573/642 (89%)	531 (93%)	42 (7%)	0	100	100
1	H	573/642 (89%)	531 (93%)	42 (7%)	0	100	100
1	I	573/642 (89%)	531 (93%)	42 (7%)	0	100	100
1	J	573/642 (89%)	531 (93%)	42 (7%)	0	100	100
1	K	573/642 (89%)	531 (93%)	42 (7%)	0	100	100
1	L	573/642 (89%)	531 (93%)	42 (7%)	0	100	100
1	M	573/642 (89%)	531 (93%)	42 (7%)	0	100	100
1	N	573/642 (89%)	531 (93%)	42 (7%)	0	100	100
1	O	573/642 (89%)	531 (93%)	42 (7%)	0	100	100
1	P	573/642 (89%)	531 (93%)	42 (7%)	0	100	100
All	All	9168/10272 (89%)	8496 (93%)	672 (7%)	0	100	100

There are no Ramachandran outliers to report.

5.3.2 Protein sidechains [i](#)

In the following table, the Percentiles column shows the percent sidechain outliers of the chain as a percentile score with respect to all PDB entries followed by that with respect to all EM entries.

The Analysed column shows the number of residues for which the sidechain conformation was analysed, and the total number of residues.

Mol	Chain	Analysed	Rotameric	Outliers	Percentiles	
1	A	508/562 (90%)	501 (99%)	7 (1%)	67	85
1	B	508/562 (90%)	501 (99%)	7 (1%)	67	85
1	C	508/562 (90%)	501 (99%)	7 (1%)	67	85
1	D	508/562 (90%)	501 (99%)	7 (1%)	67	85
1	E	508/562 (90%)	501 (99%)	7 (1%)	67	85
1	F	508/562 (90%)	500 (98%)	8 (2%)	62	83
1	G	508/562 (90%)	501 (99%)	7 (1%)	67	85
1	H	508/562 (90%)	501 (99%)	7 (1%)	67	85
1	I	508/562 (90%)	501 (99%)	7 (1%)	67	85
1	J	508/562 (90%)	501 (99%)	7 (1%)	67	85
1	K	508/562 (90%)	500 (98%)	8 (2%)	62	83
1	L	508/562 (90%)	501 (99%)	7 (1%)	67	85
1	M	508/562 (90%)	501 (99%)	7 (1%)	67	85
1	N	508/562 (90%)	500 (98%)	8 (2%)	62	83
1	O	508/562 (90%)	501 (99%)	7 (1%)	67	85
1	P	508/562 (90%)	500 (98%)	8 (2%)	62	83
All	All	8128/8992 (90%)	8012 (99%)	116 (1%)	68	85

All (116) residues with a non-rotameric sidechain are listed below:

Mol	Chain	Res	Type
1	A	36	ASN
1	A	216	ARG
1	A	255	ASN
1	A	257	ARG
1	A	355	LYS
1	A	414	ASN
1	A	581	ARG
1	B	36	ASN
1	B	216	ARG
1	B	255	ASN
1	B	257	ARG
1	B	355	LYS
1	B	414	ASN
1	B	581	ARG

Continued on next page...

Continued from previous page...

Mol	Chain	Res	Type
1	C	36	ASN
1	C	216	ARG
1	C	255	ASN
1	C	257	ARG
1	C	355	LYS
1	C	414	ASN
1	C	581	ARG
1	D	36	ASN
1	D	216	ARG
1	D	255	ASN
1	D	257	ARG
1	D	355	LYS
1	D	414	ASN
1	D	581	ARG
1	E	36	ASN
1	E	216	ARG
1	E	255	ASN
1	E	257	ARG
1	E	355	LYS
1	E	414	ASN
1	E	581	ARG
1	F	36	ASN
1	F	216	ARG
1	F	255	ASN
1	F	257	ARG
1	F	355	LYS
1	F	414	ASN
1	F	444	ARG
1	F	581	ARG
1	G	36	ASN
1	G	216	ARG
1	G	255	ASN
1	G	257	ARG
1	G	355	LYS
1	G	414	ASN
1	G	581	ARG
1	H	36	ASN
1	H	216	ARG
1	H	255	ASN
1	H	257	ARG
1	H	355	LYS
1	H	414	ASN

Continued on next page...

Continued from previous page...

Mol	Chain	Res	Type
1	H	581	ARG
1	I	36	ASN
1	I	216	ARG
1	I	255	ASN
1	I	257	ARG
1	I	355	LYS
1	I	414	ASN
1	I	581	ARG
1	J	36	ASN
1	J	216	ARG
1	J	255	ASN
1	J	257	ARG
1	J	355	LYS
1	J	414	ASN
1	J	581	ARG
1	K	36	ASN
1	K	216	ARG
1	K	255	ASN
1	K	257	ARG
1	K	355	LYS
1	K	414	ASN
1	K	444	ARG
1	K	581	ARG
1	L	36	ASN
1	L	216	ARG
1	L	255	ASN
1	L	257	ARG
1	L	355	LYS
1	L	414	ASN
1	L	581	ARG
1	M	36	ASN
1	M	216	ARG
1	M	255	ASN
1	M	257	ARG
1	M	355	LYS
1	M	414	ASN
1	M	581	ARG
1	N	36	ASN
1	N	216	ARG
1	N	255	ASN
1	N	257	ARG
1	N	355	LYS

Continued on next page...

Continued from previous page...

Mol	Chain	Res	Type
1	N	414	ASN
1	N	444	ARG
1	N	581	ARG
1	O	36	ASN
1	O	216	ARG
1	O	255	ASN
1	O	257	ARG
1	O	355	LYS
1	O	414	ASN
1	O	581	ARG
1	P	36	ASN
1	P	216	ARG
1	P	255	ASN
1	P	257	ARG
1	P	355	LYS
1	P	414	ASN
1	P	444	ARG
1	P	581	ARG

Sometimes sidechains can be flipped to improve hydrogen bonding and reduce clashes. All (91) such sidechains are listed below:

Mol	Chain	Res	Type
1	A	36	ASN
1	A	255	ASN
1	A	281	ASN
1	A	370	GLN
1	A	414	ASN
1	A	612	GLN
1	B	36	ASN
1	B	255	ASN
1	B	281	ASN
1	B	370	GLN
1	B	414	ASN
1	B	612	GLN
1	C	36	ASN
1	C	255	ASN
1	C	281	ASN
1	C	370	GLN
1	C	414	ASN
1	C	612	GLN
1	D	36	ASN
1	D	255	ASN

Continued on next page...

Continued from previous page...

Mol	Chain	Res	Type
1	D	281	ASN
1	D	370	GLN
1	D	414	ASN
1	D	612	GLN
1	E	36	ASN
1	E	255	ASN
1	E	281	ASN
1	E	370	GLN
1	E	414	ASN
1	E	612	GLN
1	F	36	ASN
1	F	255	ASN
1	F	370	GLN
1	F	414	ASN
1	F	612	GLN
1	G	36	ASN
1	G	255	ASN
1	G	370	GLN
1	G	414	ASN
1	G	612	GLN
1	H	36	ASN
1	H	255	ASN
1	H	281	ASN
1	H	370	GLN
1	H	414	ASN
1	H	612	GLN
1	I	36	ASN
1	I	255	ASN
1	I	281	ASN
1	I	370	GLN
1	I	414	ASN
1	I	612	GLN
1	J	36	ASN
1	J	255	ASN
1	J	281	ASN
1	J	370	GLN
1	J	414	ASN
1	J	612	GLN
1	K	36	ASN
1	K	255	ASN
1	K	281	ASN
1	K	370	GLN

Continued on next page...

Continued from previous page...

Mol	Chain	Res	Type
1	K	414	ASN
1	K	612	GLN
1	L	36	ASN
1	L	255	ASN
1	L	281	ASN
1	L	370	GLN
1	L	414	ASN
1	L	612	GLN
1	M	36	ASN
1	M	255	ASN
1	M	281	ASN
1	M	370	GLN
1	M	414	ASN
1	M	612	GLN
1	N	36	ASN
1	N	255	ASN
1	N	370	GLN
1	N	414	ASN
1	N	612	GLN
1	O	36	ASN
1	O	255	ASN
1	O	370	GLN
1	O	414	ASN
1	O	612	GLN
1	P	36	ASN
1	P	281	ASN
1	P	370	GLN
1	P	414	ASN
1	P	612	GLN

5.3.3 RNA [i](#)

There are no RNA molecules in this entry.

5.4 Non-standard residues in protein, DNA, RNA chains [i](#)

There are no non-standard protein/DNA/RNA residues in this entry.

5.5 Carbohydrates [i](#)

64 monosaccharides are modelled in this entry.

In the following table, the Counts columns list the number of bonds (or angles) for which Mogul statistics could be retrieved, the number of bonds (or angles) that are observed in the model and the number of bonds (or angles) that are defined in the Chemical Component Dictionary. The Link column lists molecule types, if any, to which the group is linked. The Z score for a bond length (or angle) is the number of standard deviations the observed value is removed from the expected value. A bond length (or angle) with $|Z| > 2$ is considered an outlier worth inspection. RMSZ is the root-mean-square of all Z scores of the bond lengths (or angles).

Mol	Type	Chain	Res	Link	Bond lengths			Bond angles		
					Counts	RMSZ	$\# Z > 2$	Counts	RMSZ	$\# Z > 2$
2	NAG	Q	1	2,1	14,14,15	0.26	0	17,19,21	0.49	0
2	NAG	Q	2	2	14,14,15	0.36	0	17,19,21	0.54	0
2	NAG	R	1	2,1	14,14,15	0.43	0	17,19,21	0.69	1 (5%)
2	NAG	R	2	2	14,14,15	0.43	0	17,19,21	0.96	1 (5%)
2	NAG	S	1	2,1	14,14,15	0.26	0	17,19,21	0.49	0
2	NAG	S	2	2	14,14,15	0.35	0	17,19,21	0.54	0
2	NAG	T	1	2,1	14,14,15	0.44	0	17,19,21	0.69	1 (5%)
2	NAG	T	2	2	14,14,15	0.44	0	17,19,21	0.97	1 (5%)
2	NAG	U	1	2,1	14,14,15	0.27	0	17,19,21	0.49	0
2	NAG	U	2	2	14,14,15	0.34	0	17,19,21	0.55	0
2	NAG	V	1	2,1	14,14,15	0.45	0	17,19,21	0.70	1 (5%)
2	NAG	V	2	2	14,14,15	0.44	0	17,19,21	0.97	1 (5%)
2	NAG	W	1	2,1	14,14,15	0.25	0	17,19,21	0.50	0
2	NAG	W	2	2	14,14,15	0.35	0	17,19,21	0.54	0
2	NAG	X	1	2,1	14,14,15	0.44	0	17,19,21	0.70	1 (5%)
2	NAG	X	2	2	14,14,15	0.44	0	17,19,21	0.97	1 (5%)
2	NAG	Y	1	2,1	14,14,15	0.25	0	17,19,21	0.49	0
2	NAG	Y	2	2	14,14,15	0.36	0	17,19,21	0.54	0
2	NAG	Z	1	2,1	14,14,15	0.45	0	17,19,21	0.69	1 (5%)
2	NAG	Z	2	2	14,14,15	0.44	0	17,19,21	0.97	1 (5%)
2	NAG	a	1	2,1	14,14,15	0.26	0	17,19,21	0.49	0
2	NAG	a	2	2	14,14,15	0.36	0	17,19,21	0.54	0
2	NAG	b	1	2,1	14,14,15	0.44	0	17,19,21	0.70	1 (5%)
2	NAG	b	2	2	14,14,15	0.45	0	17,19,21	0.97	1 (5%)
2	NAG	c	1	2,1	14,14,15	0.26	0	17,19,21	0.49	0
2	NAG	c	2	2	14,14,15	0.35	0	17,19,21	0.55	0
2	NAG	d	1	2,1	14,14,15	0.44	0	17,19,21	0.68	1 (5%)
2	NAG	d	2	2	14,14,15	0.44	0	17,19,21	0.97	1 (5%)
2	NAG	e	1	2,1	14,14,15	0.27	0	17,19,21	0.49	0
2	NAG	e	2	2	14,14,15	0.36	0	17,19,21	0.54	0
2	NAG	f	1	2,1	14,14,15	0.44	0	17,19,21	0.69	1 (5%)
2	NAG	f	2	2	14,14,15	0.43	0	17,19,21	0.97	1 (5%)

Mol	Type	Chain	Res	Link	Bond lengths			Bond angles		
					Counts	RMSZ	# Z > 2	Counts	RMSZ	# Z > 2
2	NAG	g	1	2,1	14,14,15	0.25	0	17,19,21	0.49	0
2	NAG	g	2	2	14,14,15	0.36	0	17,19,21	0.54	0
2	NAG	h	1	2,1	14,14,15	0.44	0	17,19,21	0.69	1 (5%)
2	NAG	h	2	2	14,14,15	0.44	0	17,19,21	0.97	1 (5%)
2	NAG	i	1	2,1	14,14,15	0.26	0	17,19,21	0.50	0
2	NAG	i	2	2	14,14,15	0.35	0	17,19,21	0.54	0
2	NAG	j	1	2,1	14,14,15	0.44	0	17,19,21	0.69	1 (5%)
2	NAG	j	2	2	14,14,15	0.43	0	17,19,21	0.96	1 (5%)
2	NAG	k	1	2,1	14,14,15	0.27	0	17,19,21	0.48	0
2	NAG	k	2	2	14,14,15	0.36	0	17,19,21	0.54	0
2	NAG	l	1	2,1	14,14,15	0.43	0	17,19,21	0.70	1 (5%)
2	NAG	l	2	2	14,14,15	0.44	0	17,19,21	0.97	1 (5%)
2	NAG	m	1	2,1	14,14,15	0.25	0	17,19,21	0.49	0
2	NAG	m	2	2	14,14,15	0.36	0	17,19,21	0.54	0
2	NAG	n	1	2,1	14,14,15	0.44	0	17,19,21	0.70	1 (5%)
2	NAG	n	2	2	14,14,15	0.44	0	17,19,21	0.97	1 (5%)
2	NAG	o	1	2,1	14,14,15	0.26	0	17,19,21	0.50	0
2	NAG	o	2	2	14,14,15	0.36	0	17,19,21	0.55	0
2	NAG	p	1	2,1	14,14,15	0.44	0	17,19,21	0.70	1 (5%)
2	NAG	p	2	2	14,14,15	0.43	0	17,19,21	0.96	1 (5%)
2	NAG	q	1	2,1	14,14,15	0.27	0	17,19,21	0.50	0
2	NAG	q	2	2	14,14,15	0.35	0	17,19,21	0.54	0
2	NAG	r	1	2,1	14,14,15	0.44	0	17,19,21	0.70	1 (5%)
2	NAG	r	2	2	14,14,15	0.43	0	17,19,21	0.97	1 (5%)
2	NAG	s	1	2,1	14,14,15	0.27	0	17,19,21	0.50	0
2	NAG	s	2	2	14,14,15	0.34	0	17,19,21	0.54	0
2	NAG	t	1	2,1	14,14,15	0.42	0	17,19,21	0.69	1 (5%)
2	NAG	t	2	2	14,14,15	0.43	0	17,19,21	0.97	1 (5%)
2	NAG	u	1	2,1	14,14,15	0.25	0	17,19,21	0.50	0
2	NAG	u	2	2	14,14,15	0.35	0	17,19,21	0.54	0
2	NAG	v	1	2,1	14,14,15	0.43	0	17,19,21	0.70	1 (5%)
2	NAG	v	2	2	14,14,15	0.43	0	17,19,21	0.97	1 (5%)

In the following table, the Chirals column lists the number of chiral outliers, the number of chiral centers analysed, the number of these observed in the model and the number defined in the Chemical Component Dictionary. Similar counts are reported in the Torsion and Rings columns. '-' means no outliers of that kind were identified.

Mol	Type	Chain	Res	Link	Chirals	Torsions	Rings
2	NAG	Q	1	2,1	-	2/6/23/26	0/1/1/1
2	NAG	Q	2	2	-	2/6/23/26	0/1/1/1
2	NAG	R	1	2,1	-	2/6/23/26	0/1/1/1
2	NAG	R	2	2	-	3/6/23/26	0/1/1/1
2	NAG	S	1	2,1	-	2/6/23/26	0/1/1/1
2	NAG	S	2	2	-	2/6/23/26	0/1/1/1
2	NAG	T	1	2,1	-	2/6/23/26	0/1/1/1
2	NAG	T	2	2	-	3/6/23/26	0/1/1/1
2	NAG	U	1	2,1	-	2/6/23/26	0/1/1/1
2	NAG	U	2	2	-	2/6/23/26	0/1/1/1
2	NAG	V	1	2,1	-	2/6/23/26	0/1/1/1
2	NAG	V	2	2	-	3/6/23/26	0/1/1/1
2	NAG	W	1	2,1	-	2/6/23/26	0/1/1/1
2	NAG	W	2	2	-	2/6/23/26	0/1/1/1
2	NAG	X	1	2,1	-	2/6/23/26	0/1/1/1
2	NAG	X	2	2	-	3/6/23/26	0/1/1/1
2	NAG	Y	1	2,1	-	2/6/23/26	0/1/1/1
2	NAG	Y	2	2	-	2/6/23/26	0/1/1/1
2	NAG	Z	1	2,1	-	2/6/23/26	0/1/1/1
2	NAG	Z	2	2	-	3/6/23/26	0/1/1/1
2	NAG	a	1	2,1	-	2/6/23/26	0/1/1/1
2	NAG	a	2	2	-	2/6/23/26	0/1/1/1
2	NAG	b	1	2,1	-	2/6/23/26	0/1/1/1
2	NAG	b	2	2	-	3/6/23/26	0/1/1/1
2	NAG	c	1	2,1	-	2/6/23/26	0/1/1/1
2	NAG	c	2	2	-	2/6/23/26	0/1/1/1
2	NAG	d	1	2,1	-	2/6/23/26	0/1/1/1
2	NAG	d	2	2	-	3/6/23/26	0/1/1/1
2	NAG	e	1	2,1	-	2/6/23/26	0/1/1/1
2	NAG	e	2	2	-	2/6/23/26	0/1/1/1
2	NAG	f	1	2,1	-	2/6/23/26	0/1/1/1
2	NAG	f	2	2	-	3/6/23/26	0/1/1/1
2	NAG	g	1	2,1	-	2/6/23/26	0/1/1/1
2	NAG	g	2	2	-	2/6/23/26	0/1/1/1
2	NAG	h	1	2,1	-	2/6/23/26	0/1/1/1

Continued on next page...

Continued from previous page...

Mol	Type	Chain	Res	Link	Chirals	Torsions	Rings
2	NAG	h	2	2	-	3/6/23/26	0/1/1/1
2	NAG	i	1	2,1	-	2/6/23/26	0/1/1/1
2	NAG	i	2	2	-	2/6/23/26	0/1/1/1
2	NAG	j	1	2,1	-	2/6/23/26	0/1/1/1
2	NAG	j	2	2	-	3/6/23/26	0/1/1/1
2	NAG	k	1	2,1	-	2/6/23/26	0/1/1/1
2	NAG	k	2	2	-	2/6/23/26	0/1/1/1
2	NAG	l	1	2,1	-	2/6/23/26	0/1/1/1
2	NAG	l	2	2	-	3/6/23/26	0/1/1/1
2	NAG	m	1	2,1	-	2/6/23/26	0/1/1/1
2	NAG	m	2	2	-	2/6/23/26	0/1/1/1
2	NAG	n	1	2,1	-	2/6/23/26	0/1/1/1
2	NAG	n	2	2	-	3/6/23/26	0/1/1/1
2	NAG	o	1	2,1	-	2/6/23/26	0/1/1/1
2	NAG	o	2	2	-	2/6/23/26	0/1/1/1
2	NAG	p	1	2,1	-	2/6/23/26	0/1/1/1
2	NAG	p	2	2	-	3/6/23/26	0/1/1/1
2	NAG	q	1	2,1	-	2/6/23/26	0/1/1/1
2	NAG	q	2	2	-	2/6/23/26	0/1/1/1
2	NAG	r	1	2,1	-	2/6/23/26	0/1/1/1
2	NAG	r	2	2	-	3/6/23/26	0/1/1/1
2	NAG	s	1	2,1	-	2/6/23/26	0/1/1/1
2	NAG	s	2	2	-	2/6/23/26	0/1/1/1
2	NAG	t	1	2,1	-	2/6/23/26	0/1/1/1
2	NAG	t	2	2	-	3/6/23/26	0/1/1/1
2	NAG	u	1	2,1	-	2/6/23/26	0/1/1/1
2	NAG	u	2	2	-	2/6/23/26	0/1/1/1
2	NAG	v	1	2,1	-	2/6/23/26	0/1/1/1
2	NAG	v	2	2	-	3/6/23/26	0/1/1/1

There are no bond length outliers.

All (32) bond angle outliers are listed below:

Mol	Chain	Res	Type	Atoms	Z	Observed(°)	Ideal(°)
2	b	2	NAG	C2-N2-C7	3.08	127.29	122.90

Continued on next page...

Continued from previous page...

Mol	Chain	Res	Type	Atoms	Z	Observed(°)	Ideal(°)
2	v	2	NAG	C2-N2-C7	3.08	127.28	122.90
2	l	2	NAG	C2-N2-C7	3.07	127.28	122.90
2	X	2	NAG	C2-N2-C7	3.06	127.26	122.90
2	h	2	NAG	C2-N2-C7	3.06	127.26	122.90
2	t	2	NAG	C2-N2-C7	3.05	127.25	122.90
2	R	2	NAG	C2-N2-C7	3.05	127.25	122.90
2	Z	2	NAG	C2-N2-C7	3.05	127.25	122.90
2	n	2	NAG	C2-N2-C7	3.05	127.25	122.90
2	T	2	NAG	C2-N2-C7	3.04	127.24	122.90
2	d	2	NAG	C2-N2-C7	3.04	127.23	122.90
2	r	2	NAG	C2-N2-C7	3.04	127.22	122.90
2	f	2	NAG	C2-N2-C7	3.03	127.21	122.90
2	j	2	NAG	C2-N2-C7	3.02	127.21	122.90
2	p	2	NAG	C2-N2-C7	3.02	127.21	122.90
2	V	2	NAG	C2-N2-C7	3.02	127.20	122.90
2	l	1	NAG	C1-O5-C5	2.51	115.59	112.19
2	n	1	NAG	C1-O5-C5	2.50	115.59	112.19
2	b	1	NAG	C1-O5-C5	2.50	115.58	112.19
2	r	1	NAG	C1-O5-C5	2.50	115.58	112.19
2	p	1	NAG	C1-O5-C5	2.49	115.57	112.19
2	v	1	NAG	C1-O5-C5	2.49	115.56	112.19
2	X	1	NAG	C1-O5-C5	2.48	115.56	112.19
2	V	1	NAG	C1-O5-C5	2.48	115.55	112.19
2	T	1	NAG	C1-O5-C5	2.48	115.55	112.19
2	Z	1	NAG	C1-O5-C5	2.47	115.54	112.19
2	j	1	NAG	C1-O5-C5	2.47	115.54	112.19
2	R	1	NAG	C1-O5-C5	2.47	115.53	112.19
2	f	1	NAG	C1-O5-C5	2.46	115.53	112.19
2	h	1	NAG	C1-O5-C5	2.46	115.53	112.19
2	t	1	NAG	C1-O5-C5	2.45	115.52	112.19
2	d	1	NAG	C1-O5-C5	2.44	115.50	112.19

There are no chirality outliers.

All (144) torsion outliers are listed below:

Mol	Chain	Res	Type	Atoms
2	R	2	NAG	O5-C5-C6-O6
2	T	2	NAG	O5-C5-C6-O6
2	V	2	NAG	O5-C5-C6-O6
2	X	2	NAG	O5-C5-C6-O6
2	Z	2	NAG	O5-C5-C6-O6
2	b	2	NAG	O5-C5-C6-O6

Continued on next page...

Continued from previous page...

Mol	Chain	Res	Type	Atoms
2	d	2	NAG	O5-C5-C6-O6
2	h	2	NAG	O5-C5-C6-O6
2	l	2	NAG	O5-C5-C6-O6
2	n	2	NAG	O5-C5-C6-O6
2	p	2	NAG	O5-C5-C6-O6
2	r	2	NAG	O5-C5-C6-O6
2	v	2	NAG	O5-C5-C6-O6
2	f	2	NAG	O5-C5-C6-O6
2	j	2	NAG	O5-C5-C6-O6
2	t	2	NAG	O5-C5-C6-O6
2	Q	2	NAG	C4-C5-C6-O6
2	S	2	NAG	C4-C5-C6-O6
2	U	2	NAG	C4-C5-C6-O6
2	W	2	NAG	C4-C5-C6-O6
2	Y	2	NAG	C4-C5-C6-O6
2	a	2	NAG	C4-C5-C6-O6
2	c	2	NAG	C4-C5-C6-O6
2	e	2	NAG	C4-C5-C6-O6
2	g	2	NAG	C4-C5-C6-O6
2	i	2	NAG	C4-C5-C6-O6
2	k	2	NAG	C4-C5-C6-O6
2	m	2	NAG	C4-C5-C6-O6
2	o	2	NAG	C4-C5-C6-O6
2	q	2	NAG	C4-C5-C6-O6
2	s	2	NAG	C4-C5-C6-O6
2	u	2	NAG	C4-C5-C6-O6
2	R	2	NAG	C4-C5-C6-O6
2	T	2	NAG	C4-C5-C6-O6
2	V	2	NAG	C4-C5-C6-O6
2	X	2	NAG	C4-C5-C6-O6
2	Z	2	NAG	C4-C5-C6-O6
2	b	2	NAG	C4-C5-C6-O6
2	d	2	NAG	C4-C5-C6-O6
2	f	2	NAG	C4-C5-C6-O6
2	h	2	NAG	C4-C5-C6-O6
2	j	2	NAG	C4-C5-C6-O6
2	l	2	NAG	C4-C5-C6-O6
2	n	2	NAG	C4-C5-C6-O6
2	p	2	NAG	C4-C5-C6-O6
2	r	2	NAG	C4-C5-C6-O6
2	t	2	NAG	C4-C5-C6-O6
2	v	2	NAG	C4-C5-C6-O6

Continued on next page...

Continued from previous page...

Mol	Chain	Res	Type	Atoms
2	R	1	NAG	C4-C5-C6-O6
2	X	1	NAG	C4-C5-C6-O6
2	Z	1	NAG	C4-C5-C6-O6
2	f	1	NAG	C4-C5-C6-O6
2	h	1	NAG	C4-C5-C6-O6
2	v	1	NAG	C4-C5-C6-O6
2	T	1	NAG	C4-C5-C6-O6
2	V	1	NAG	C4-C5-C6-O6
2	b	1	NAG	C4-C5-C6-O6
2	d	1	NAG	C4-C5-C6-O6
2	j	1	NAG	C4-C5-C6-O6
2	l	1	NAG	C4-C5-C6-O6
2	n	1	NAG	C4-C5-C6-O6
2	p	1	NAG	C4-C5-C6-O6
2	r	1	NAG	C4-C5-C6-O6
2	t	1	NAG	C4-C5-C6-O6
2	Q	2	NAG	O5-C5-C6-O6
2	S	2	NAG	O5-C5-C6-O6
2	U	2	NAG	O5-C5-C6-O6
2	W	2	NAG	O5-C5-C6-O6
2	Y	2	NAG	O5-C5-C6-O6
2	a	2	NAG	O5-C5-C6-O6
2	c	2	NAG	O5-C5-C6-O6
2	e	2	NAG	O5-C5-C6-O6
2	g	2	NAG	O5-C5-C6-O6
2	i	2	NAG	O5-C5-C6-O6
2	k	2	NAG	O5-C5-C6-O6
2	m	2	NAG	O5-C5-C6-O6
2	o	2	NAG	O5-C5-C6-O6
2	q	2	NAG	O5-C5-C6-O6
2	s	2	NAG	O5-C5-C6-O6
2	u	2	NAG	O5-C5-C6-O6
2	R	1	NAG	O5-C5-C6-O6
2	T	1	NAG	O5-C5-C6-O6
2	V	1	NAG	O5-C5-C6-O6
2	X	1	NAG	O5-C5-C6-O6
2	Z	1	NAG	O5-C5-C6-O6
2	b	1	NAG	O5-C5-C6-O6
2	d	1	NAG	O5-C5-C6-O6
2	f	1	NAG	O5-C5-C6-O6
2	h	1	NAG	O5-C5-C6-O6
2	j	1	NAG	O5-C5-C6-O6

Continued on next page...

Continued from previous page...

Mol	Chain	Res	Type	Atoms
2	l	1	NAG	O5-C5-C6-O6
2	n	1	NAG	O5-C5-C6-O6
2	p	1	NAG	O5-C5-C6-O6
2	r	1	NAG	O5-C5-C6-O6
2	t	1	NAG	O5-C5-C6-O6
2	v	1	NAG	O5-C5-C6-O6
2	Q	1	NAG	C4-C5-C6-O6
2	S	1	NAG	C4-C5-C6-O6
2	U	1	NAG	C4-C5-C6-O6
2	W	1	NAG	C4-C5-C6-O6
2	Y	1	NAG	C4-C5-C6-O6
2	a	1	NAG	C4-C5-C6-O6
2	c	1	NAG	C4-C5-C6-O6
2	e	1	NAG	C4-C5-C6-O6
2	g	1	NAG	C4-C5-C6-O6
2	i	1	NAG	C4-C5-C6-O6
2	k	1	NAG	C4-C5-C6-O6
2	m	1	NAG	C4-C5-C6-O6
2	o	1	NAG	C4-C5-C6-O6
2	q	1	NAG	C4-C5-C6-O6
2	s	1	NAG	C4-C5-C6-O6
2	u	1	NAG	C4-C5-C6-O6
2	Q	1	NAG	O5-C5-C6-O6
2	c	1	NAG	O5-C5-C6-O6
2	m	1	NAG	O5-C5-C6-O6
2	s	1	NAG	O5-C5-C6-O6
2	S	1	NAG	O5-C5-C6-O6
2	U	1	NAG	O5-C5-C6-O6
2	W	1	NAG	O5-C5-C6-O6
2	Y	1	NAG	O5-C5-C6-O6
2	a	1	NAG	O5-C5-C6-O6
2	e	1	NAG	O5-C5-C6-O6
2	g	1	NAG	O5-C5-C6-O6
2	i	1	NAG	O5-C5-C6-O6
2	k	1	NAG	O5-C5-C6-O6
2	o	1	NAG	O5-C5-C6-O6
2	q	1	NAG	O5-C5-C6-O6
2	u	1	NAG	O5-C5-C6-O6
2	R	2	NAG	C3-C2-N2-C7
2	T	2	NAG	C3-C2-N2-C7
2	V	2	NAG	C3-C2-N2-C7
2	X	2	NAG	C3-C2-N2-C7

Continued on next page...

Continued from previous page...

Mol	Chain	Res	Type	Atoms
2	Z	2	NAG	C3-C2-N2-C7
2	b	2	NAG	C3-C2-N2-C7
2	d	2	NAG	C3-C2-N2-C7
2	f	2	NAG	C3-C2-N2-C7
2	h	2	NAG	C3-C2-N2-C7
2	j	2	NAG	C3-C2-N2-C7
2	l	2	NAG	C3-C2-N2-C7
2	n	2	NAG	C3-C2-N2-C7
2	p	2	NAG	C3-C2-N2-C7
2	r	2	NAG	C3-C2-N2-C7
2	t	2	NAG	C3-C2-N2-C7
2	v	2	NAG	C3-C2-N2-C7

There are no ring outliers.

No monomer is involved in short contacts.

The following is a two-dimensional graphical depiction of Mogul quality analysis of bond lengths, bond angles, torsion angles, and ring geometry for oligosaccharide.

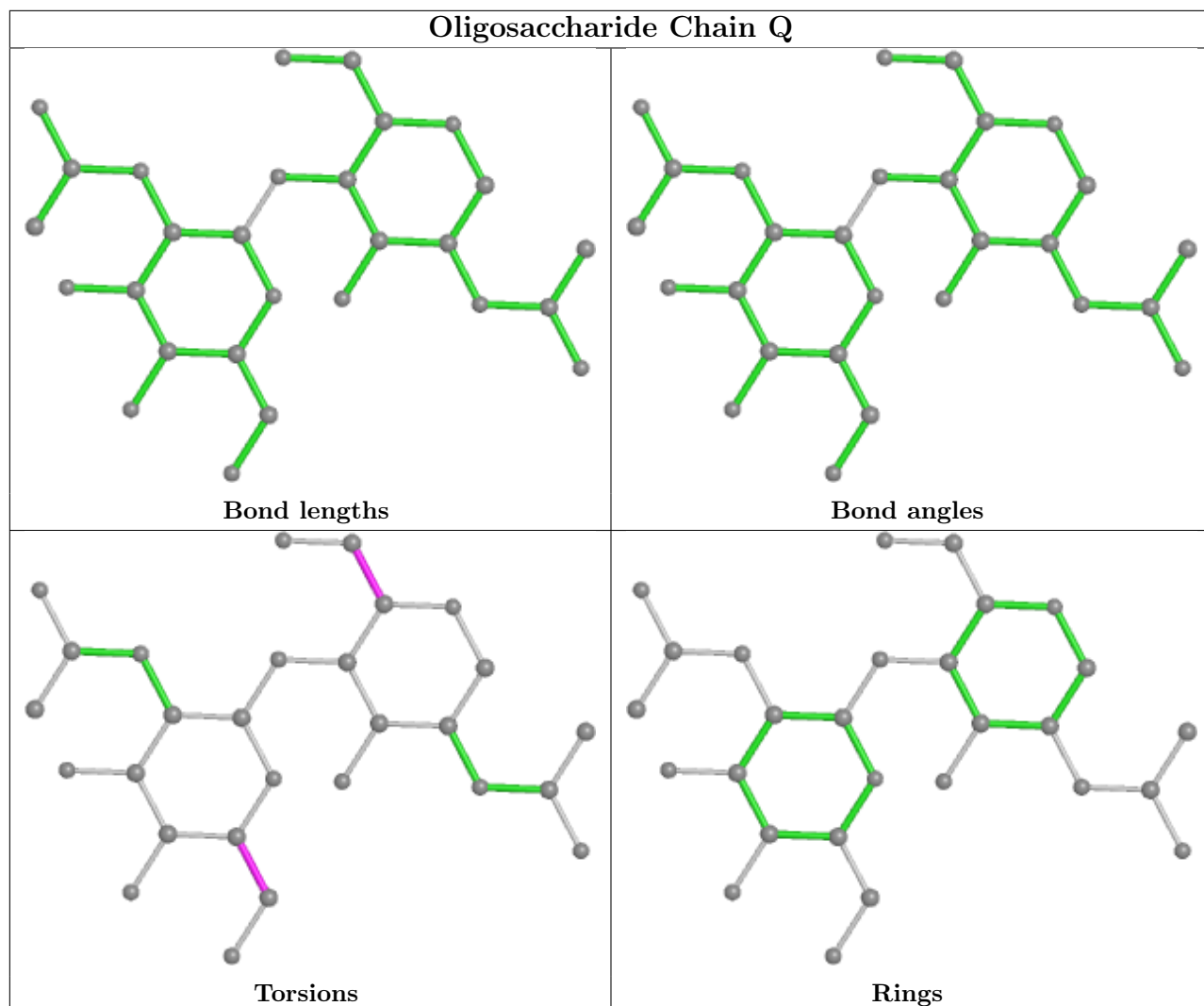

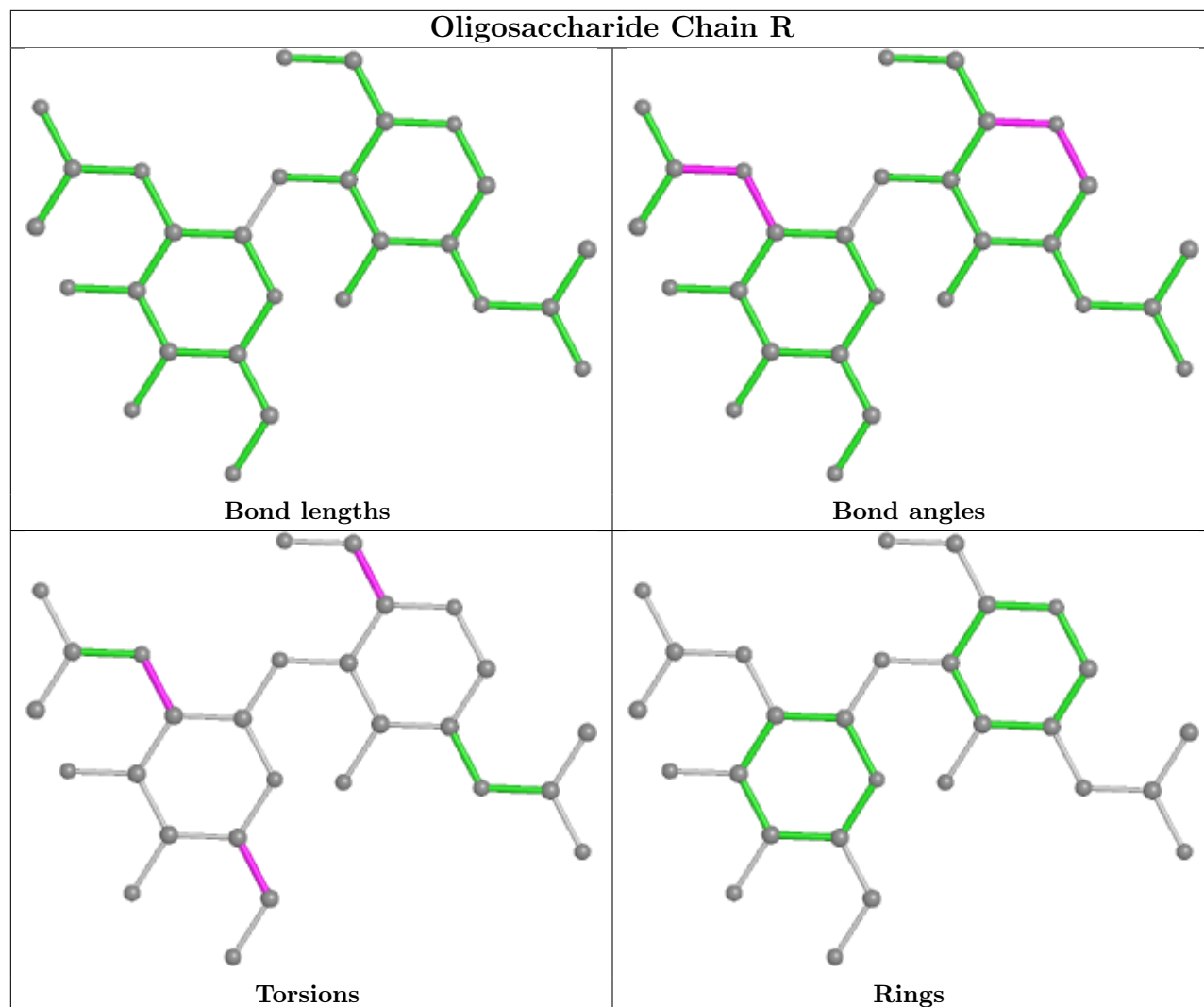

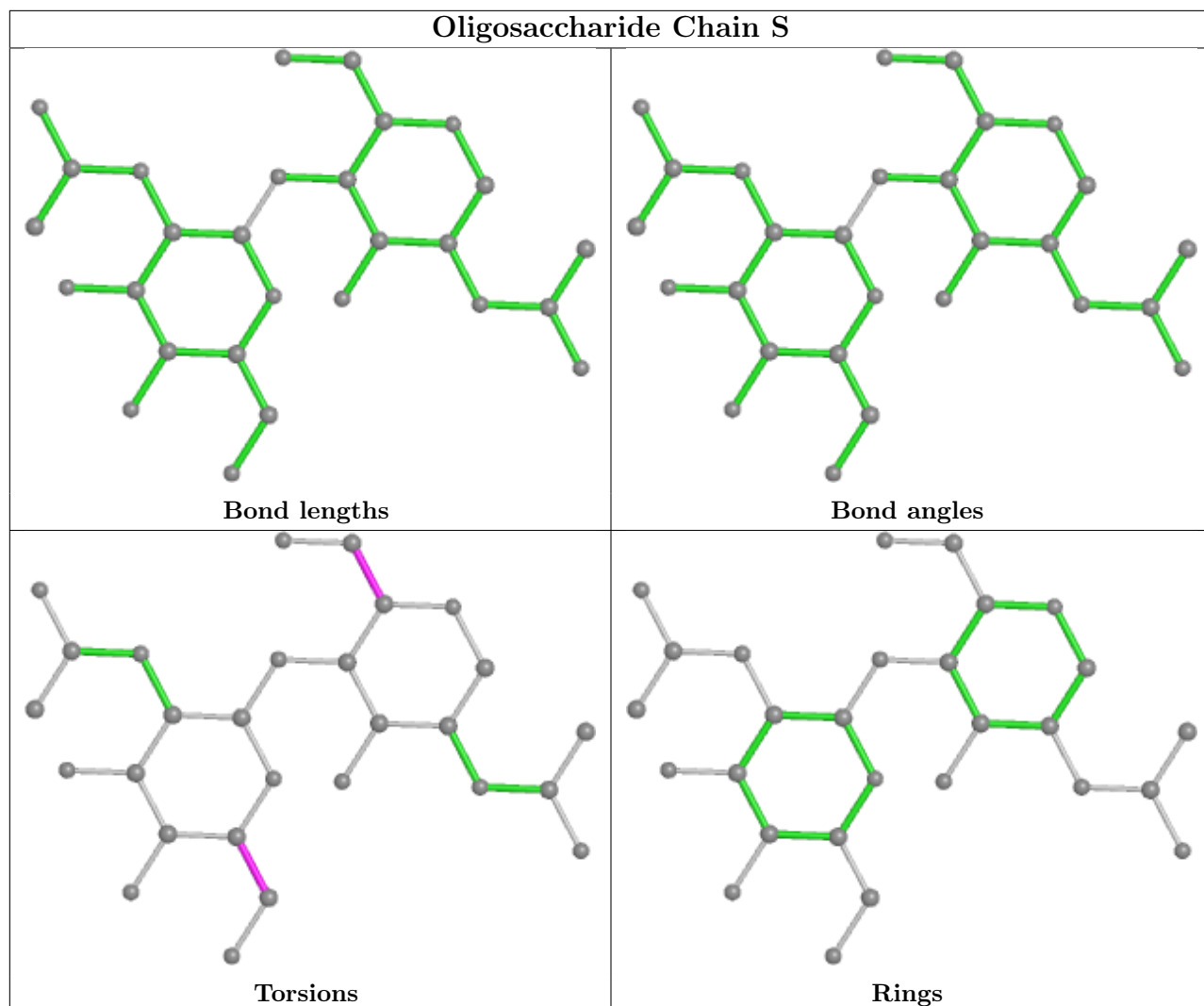

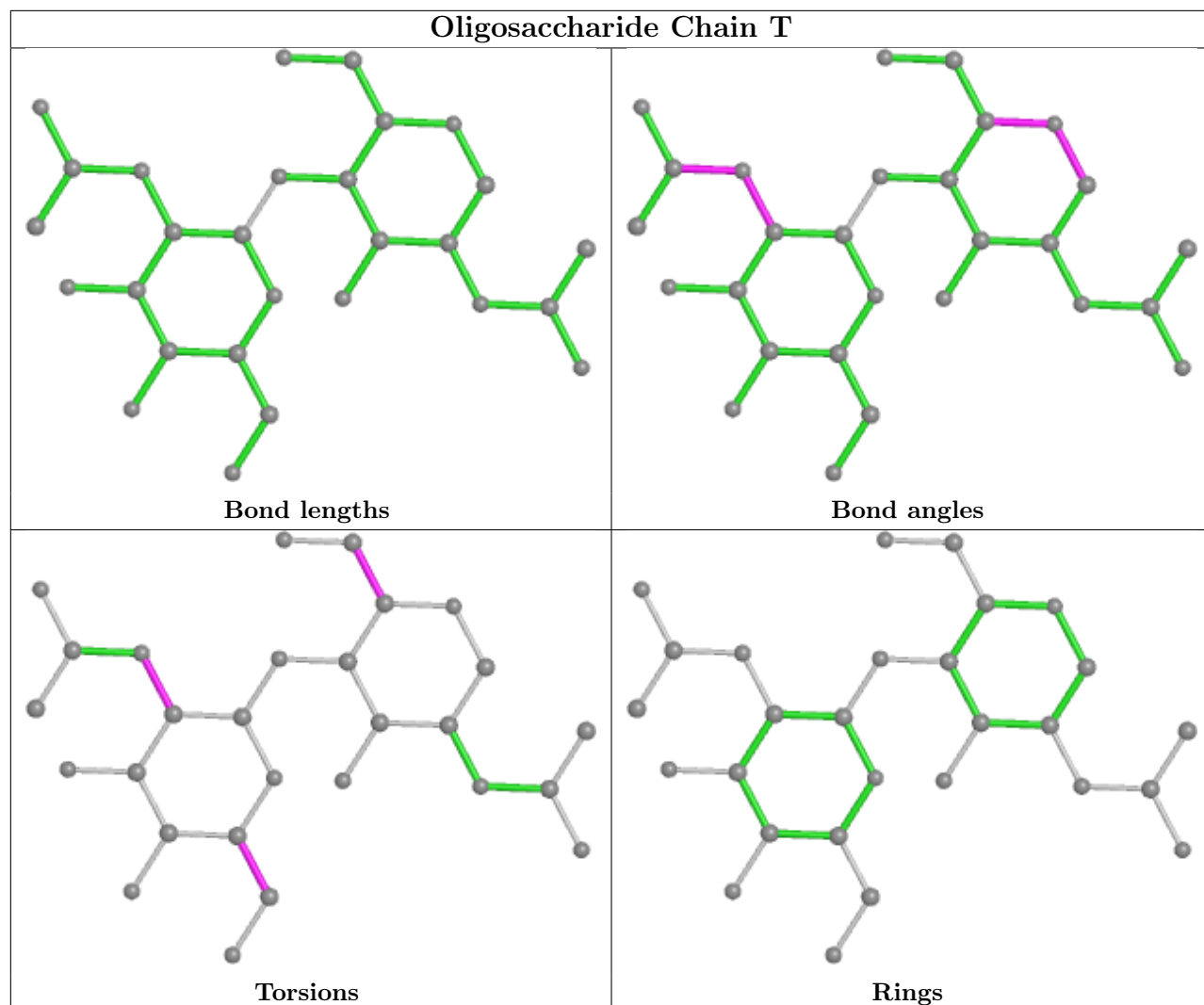

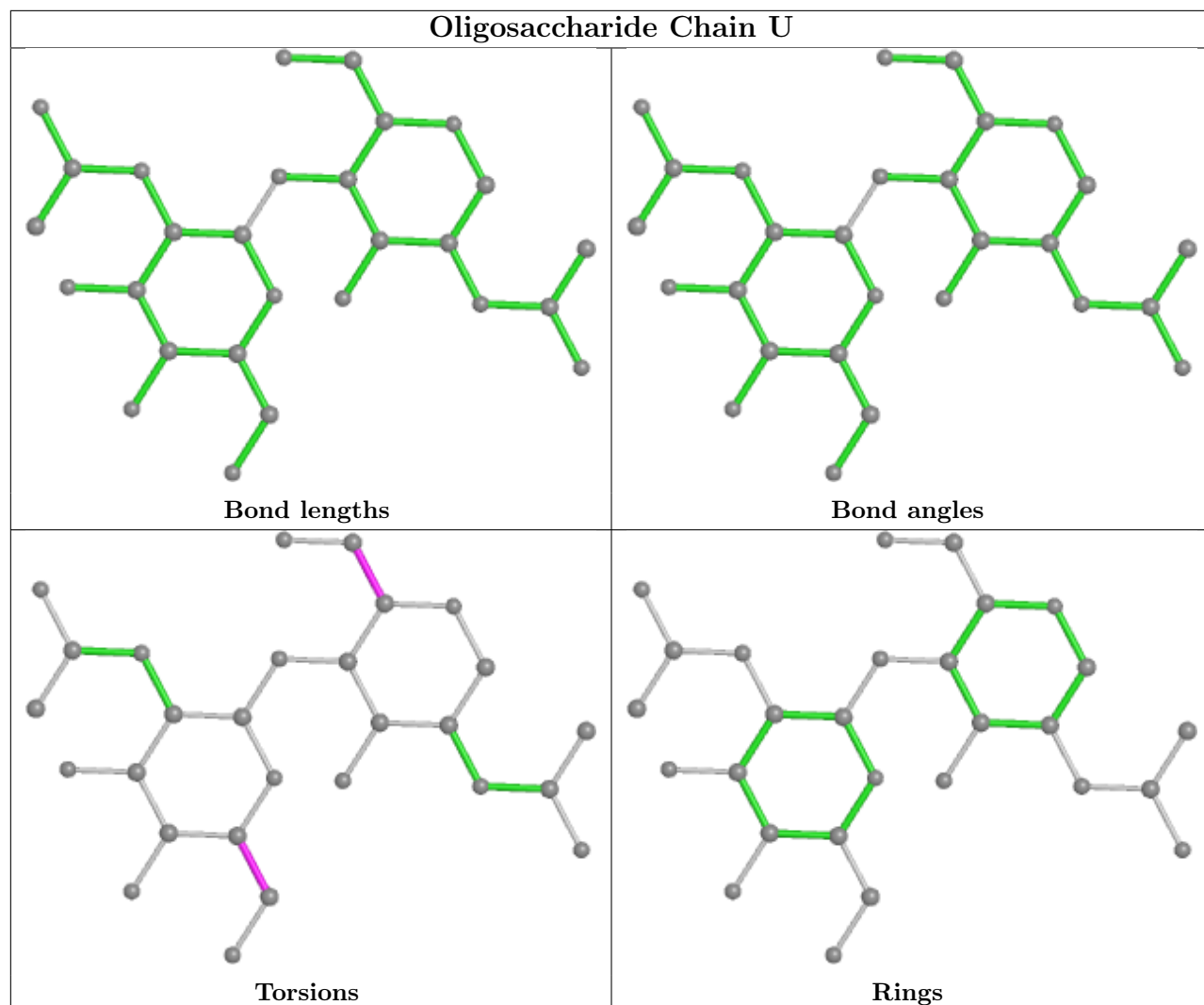

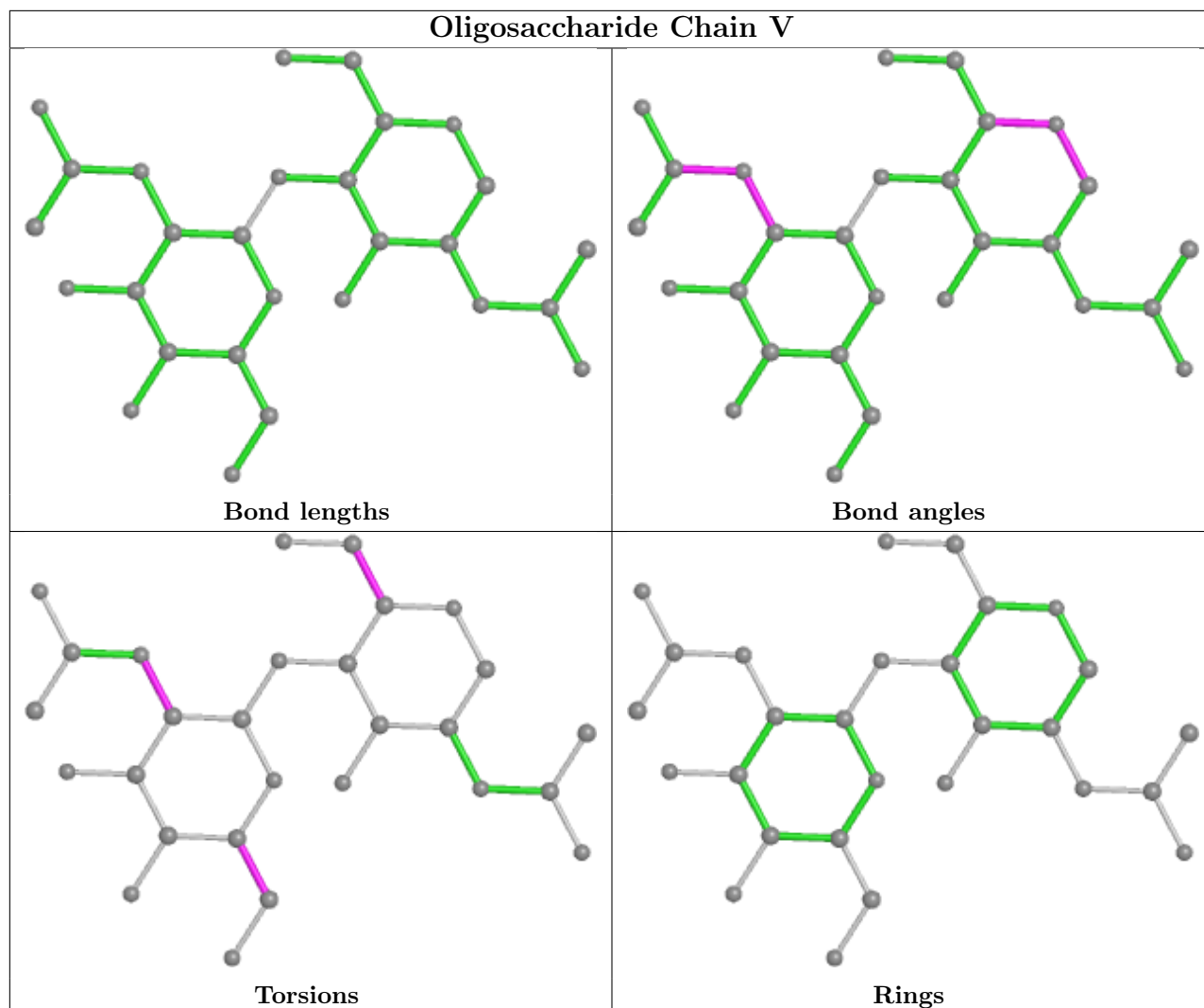

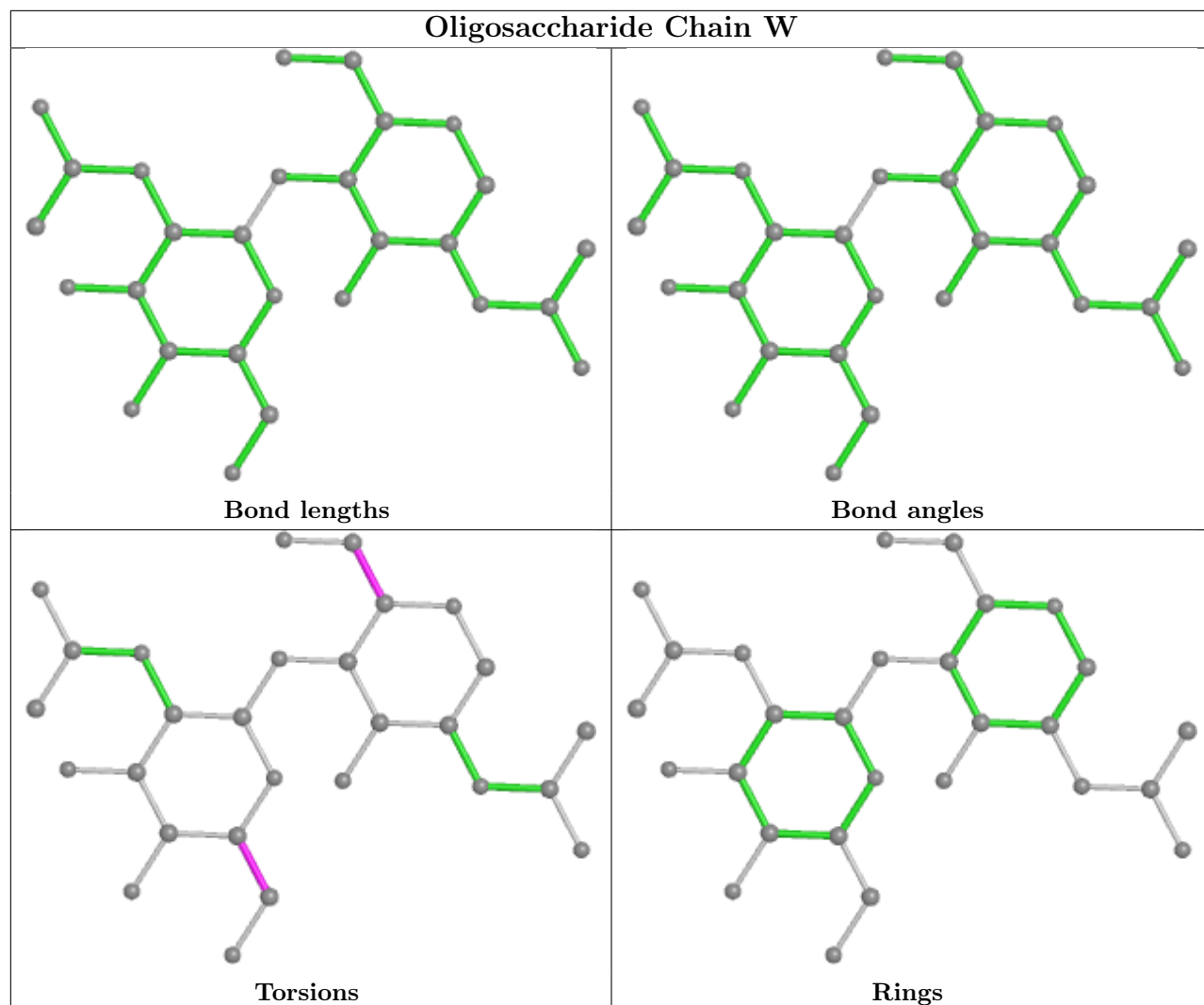

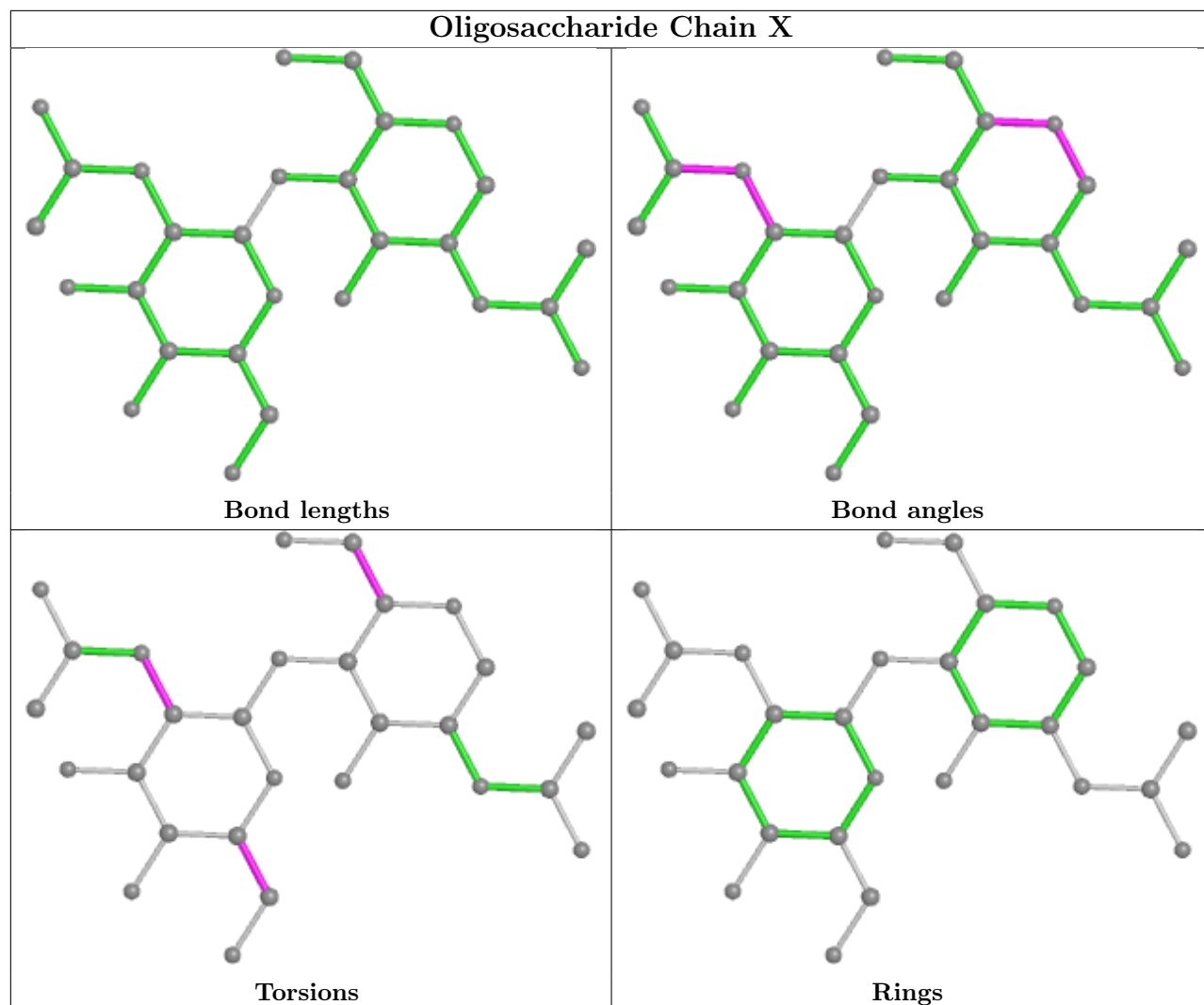

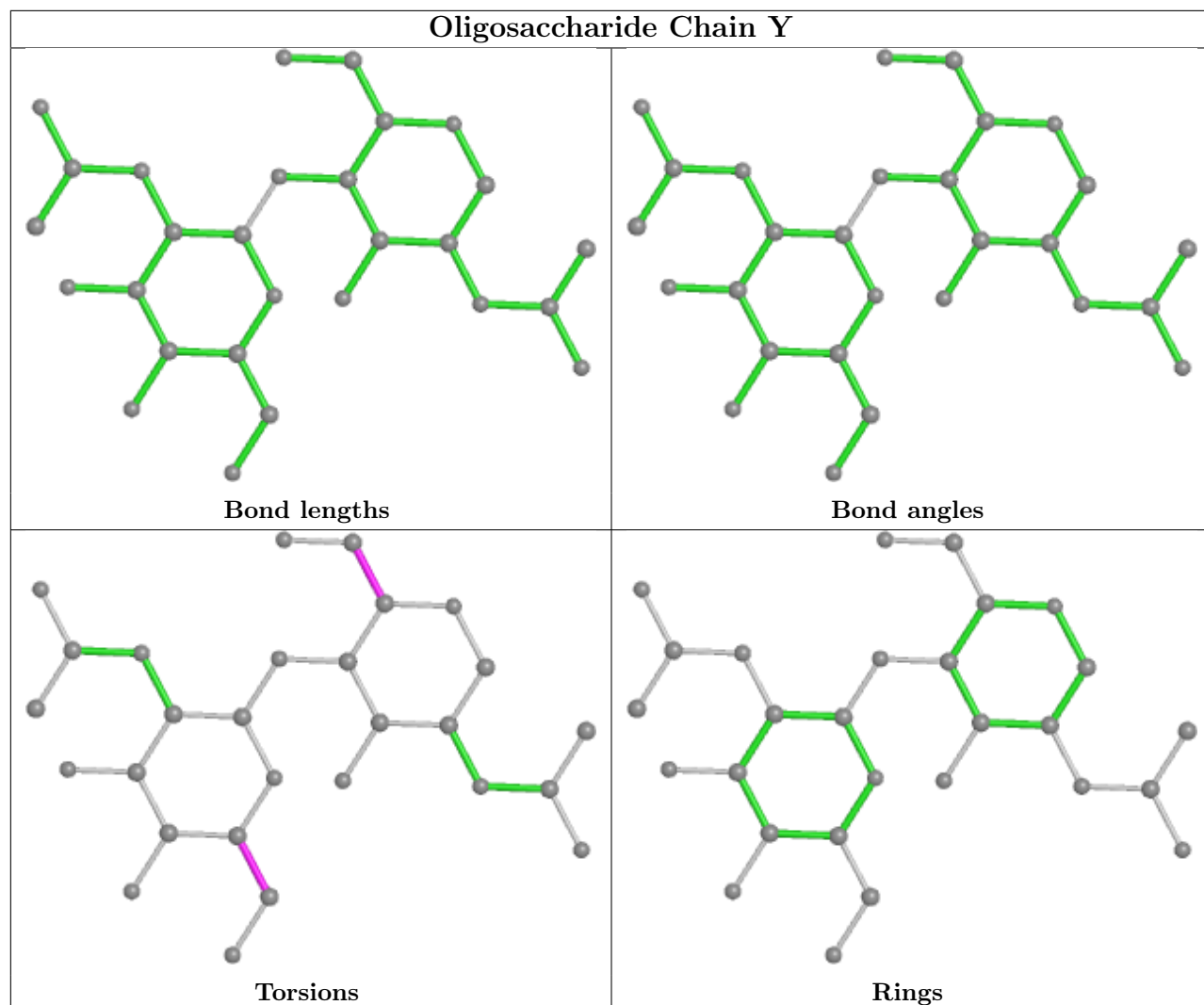

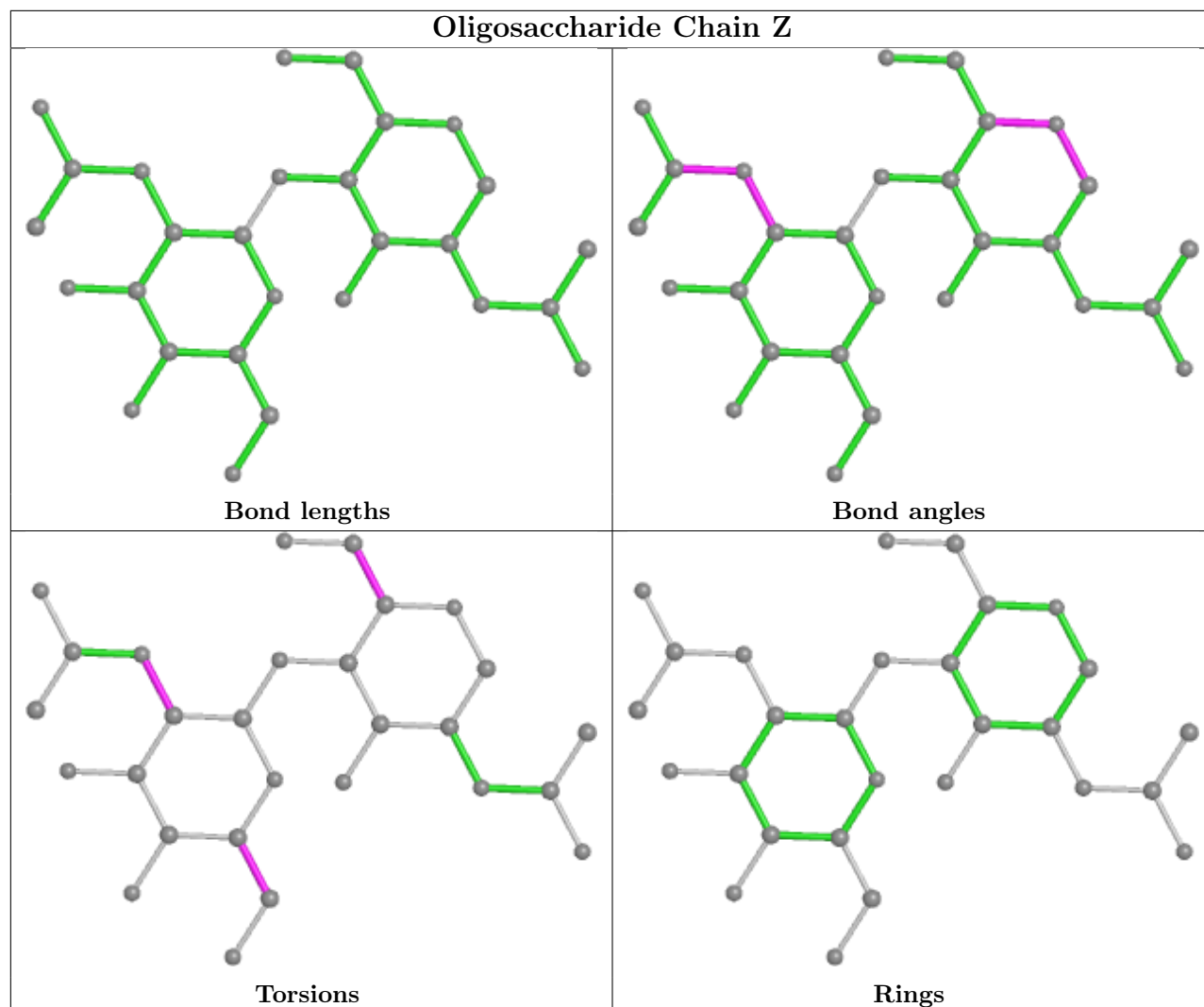

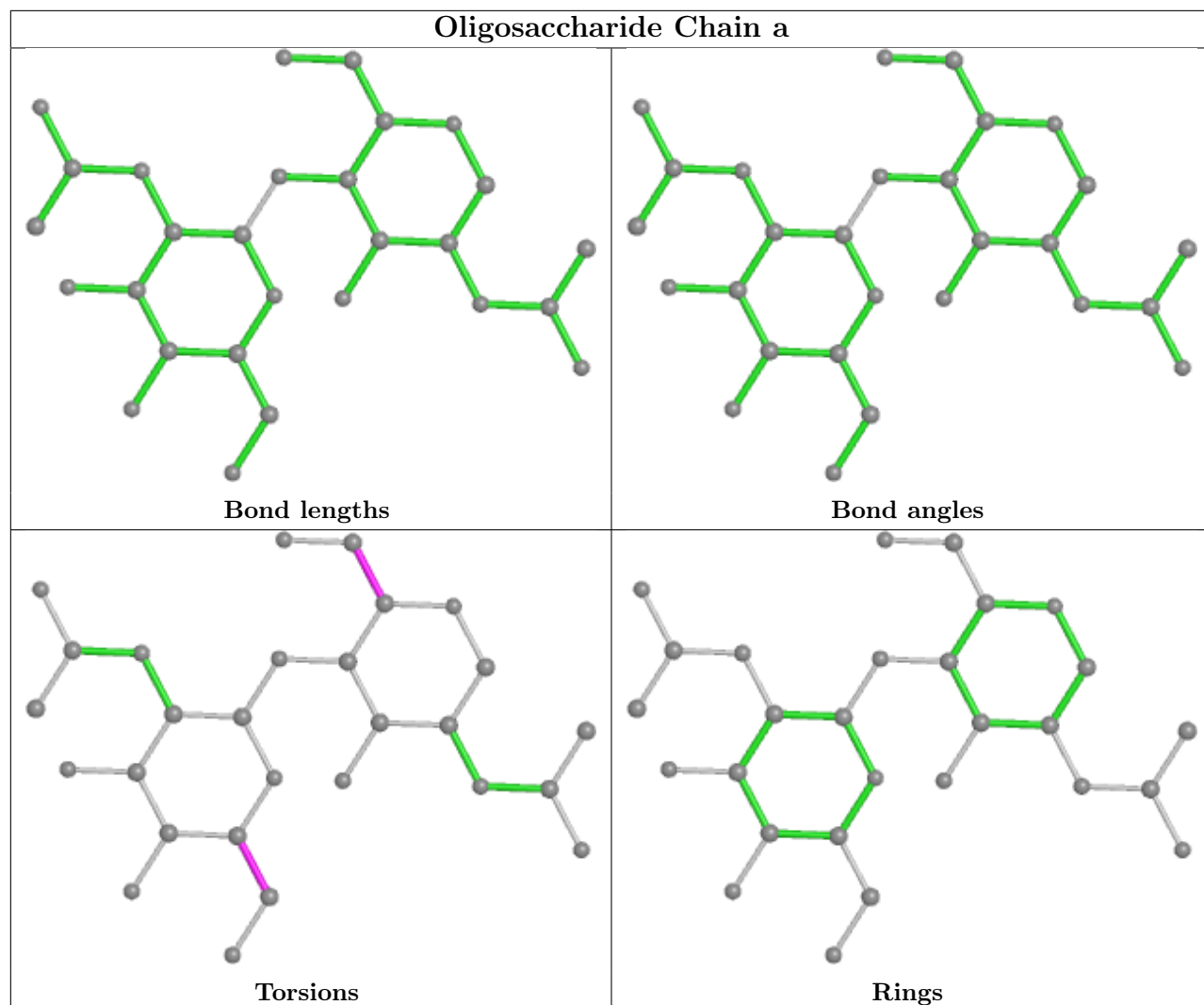

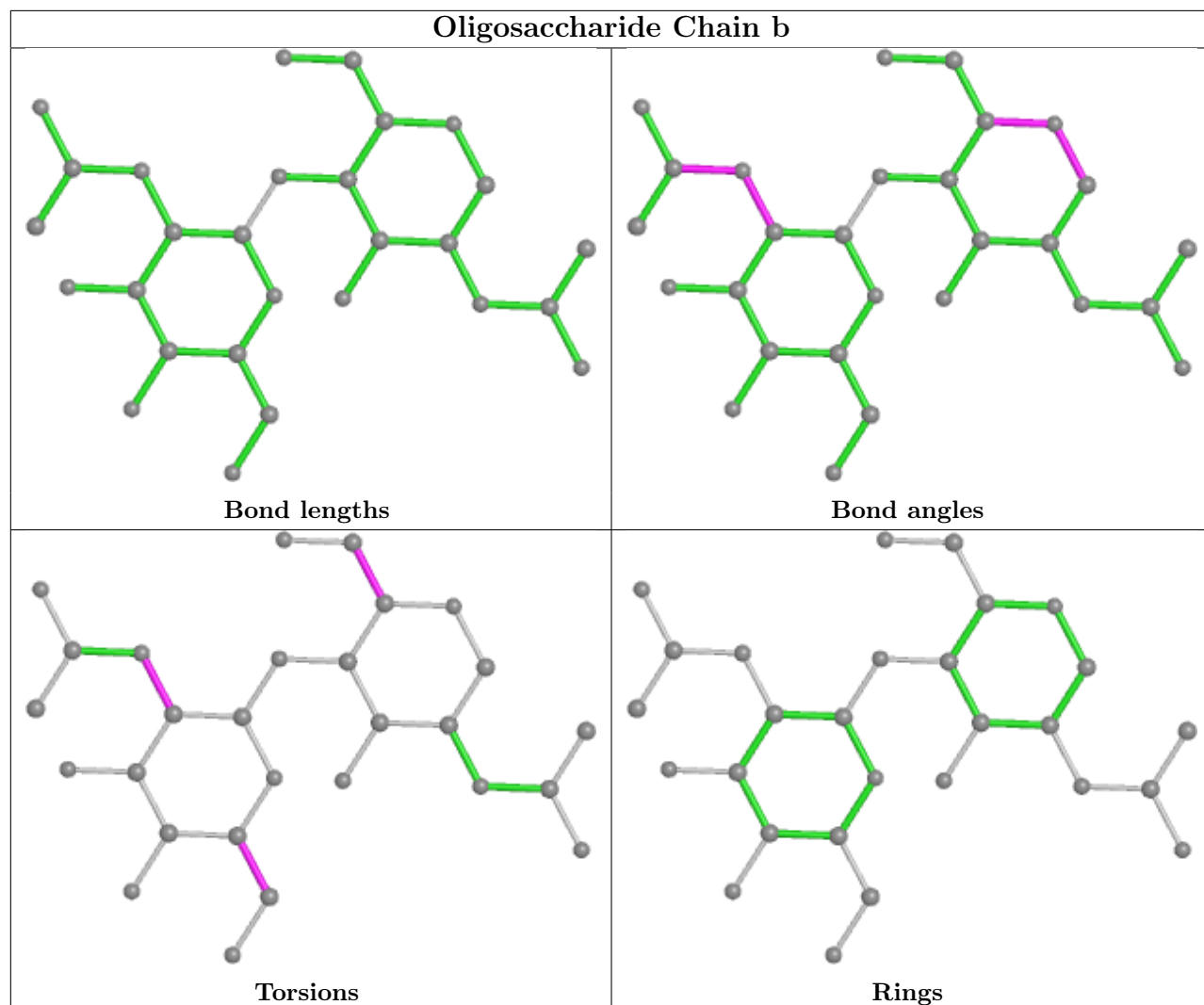

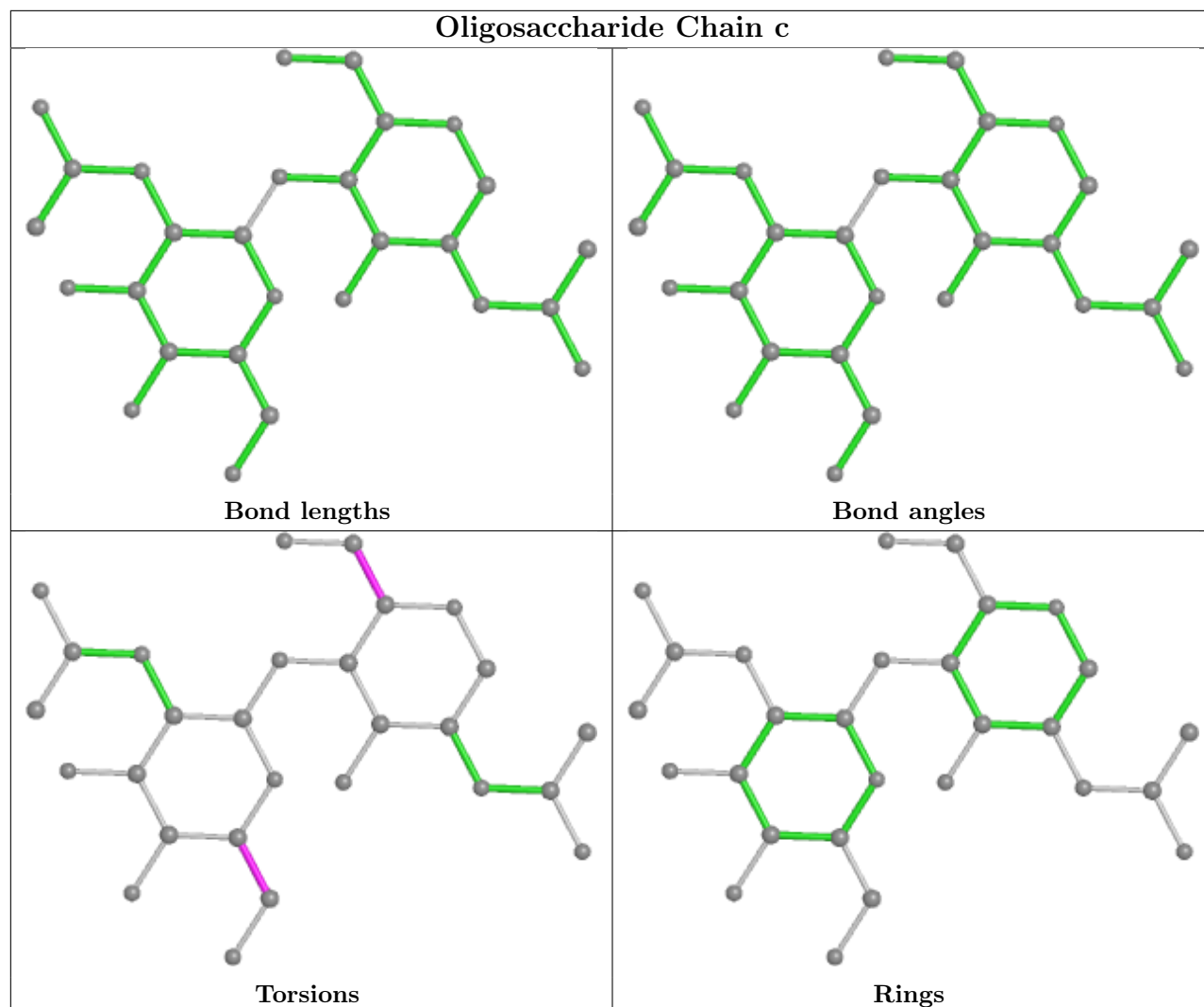

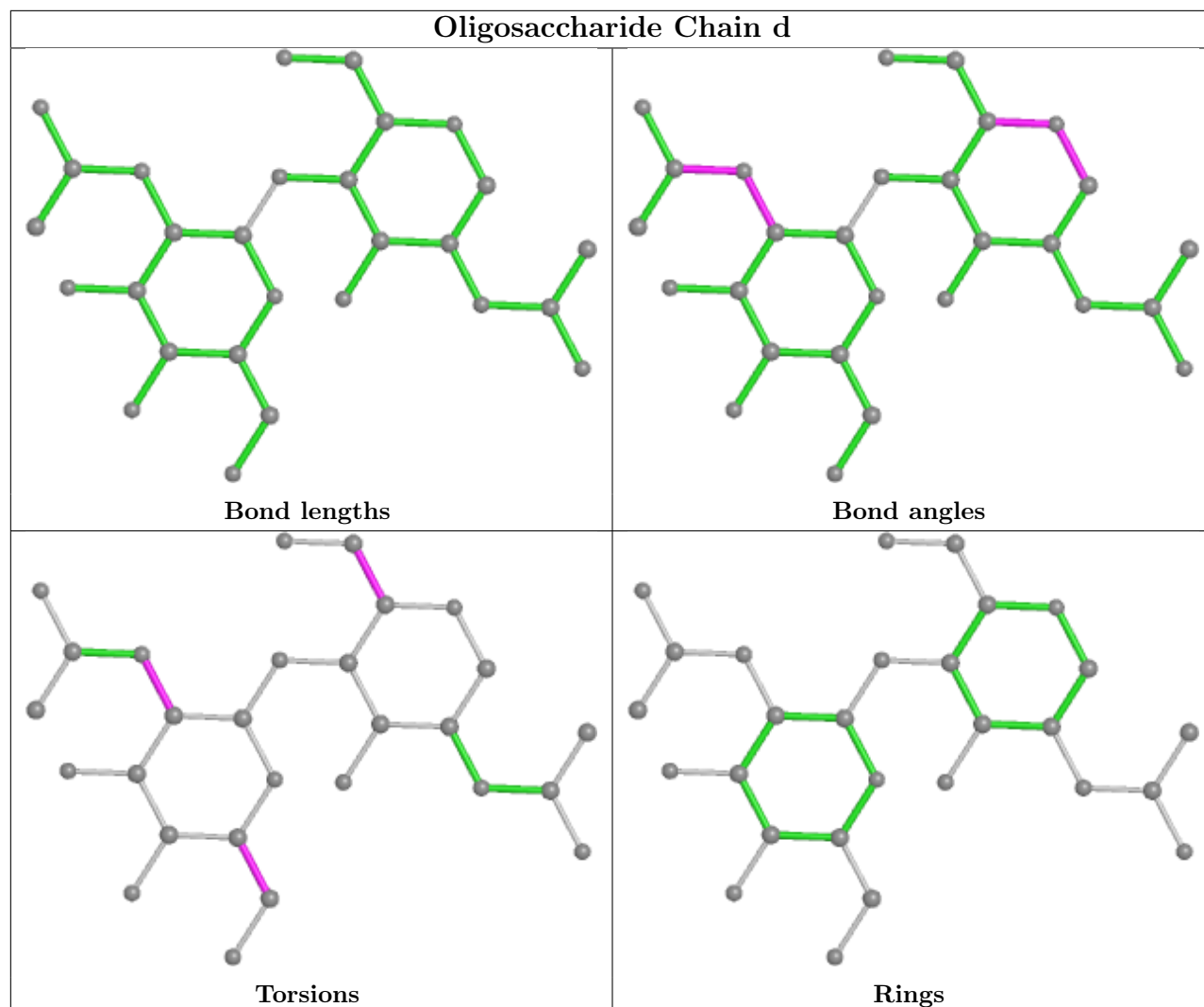

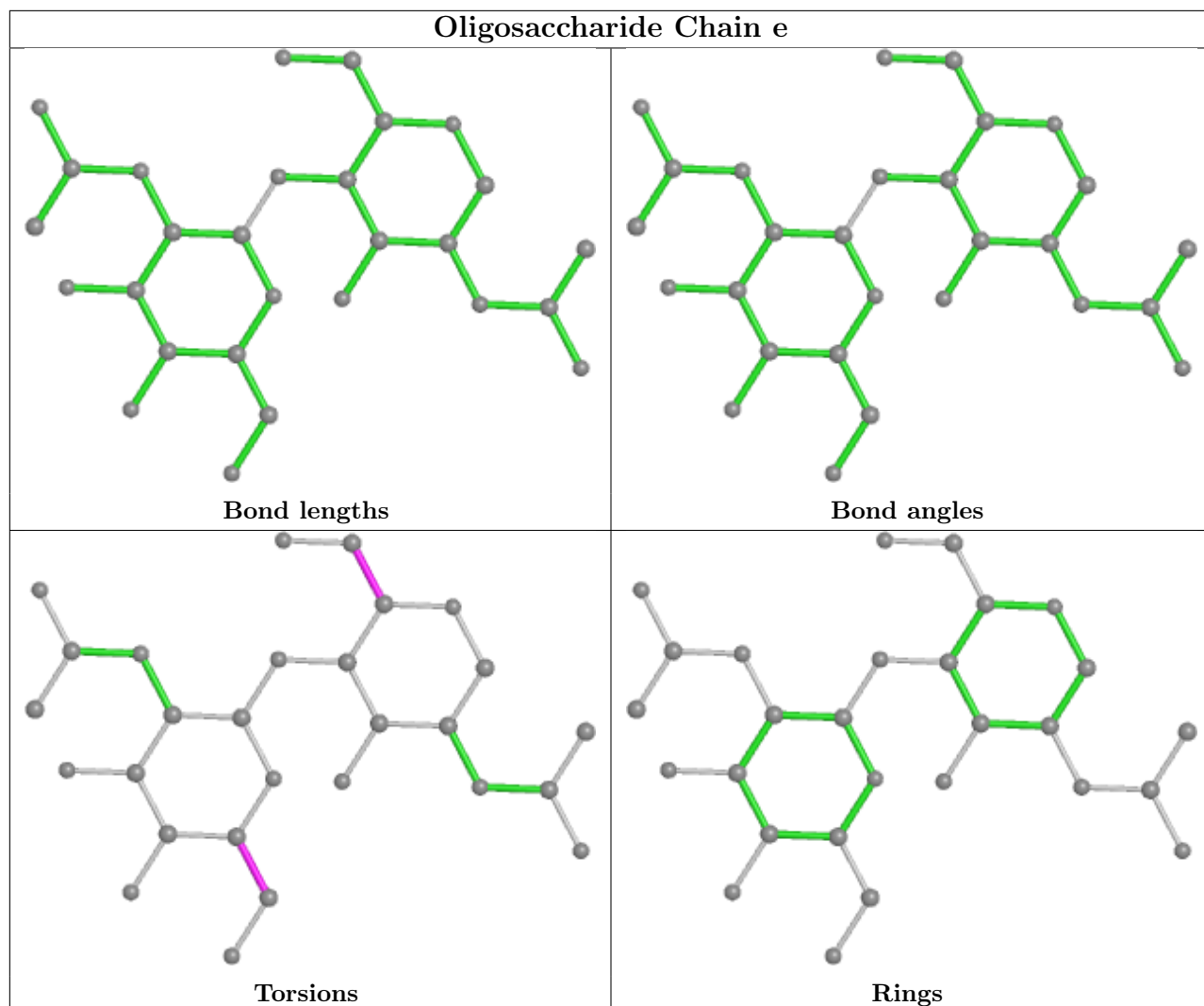

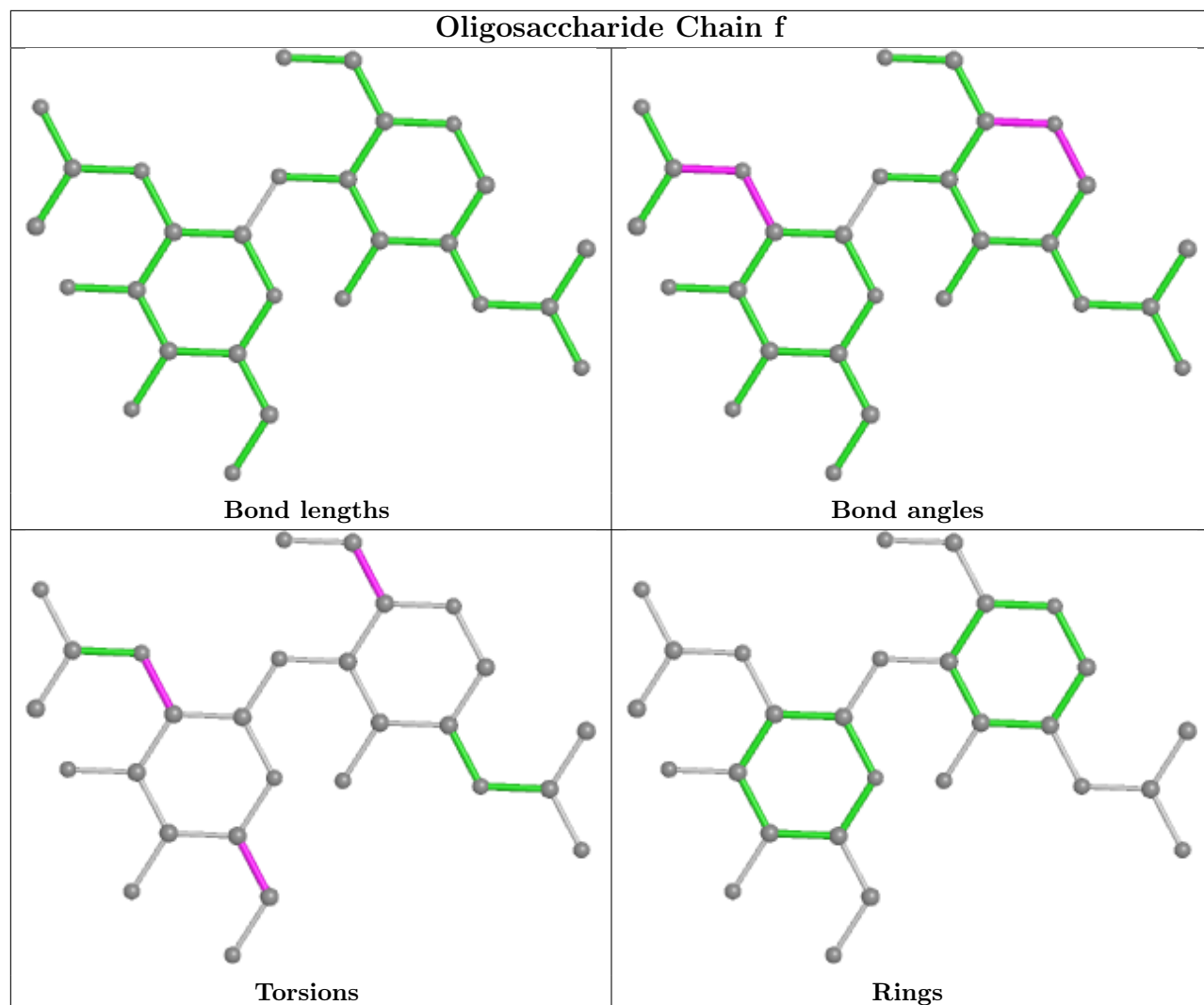

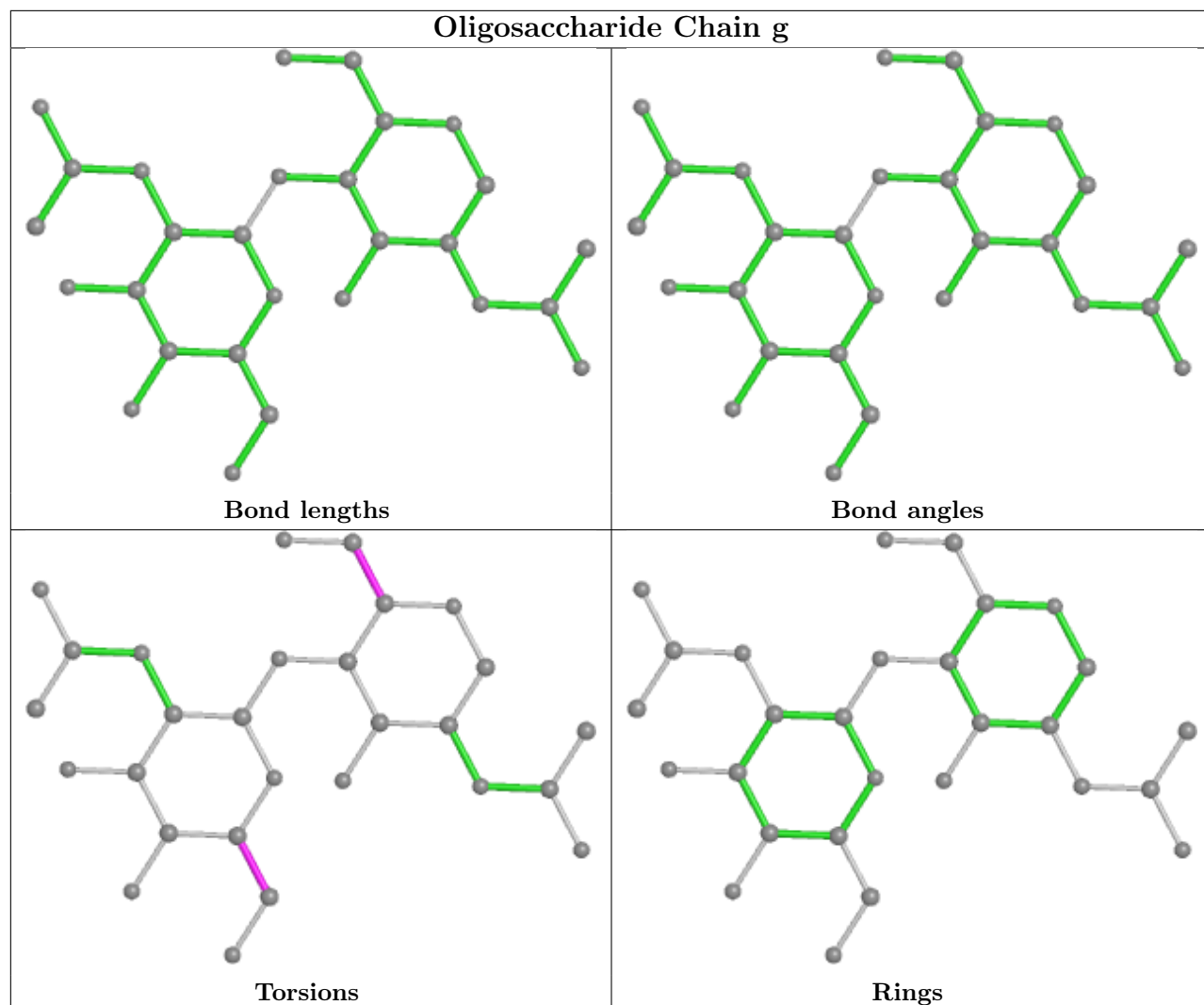

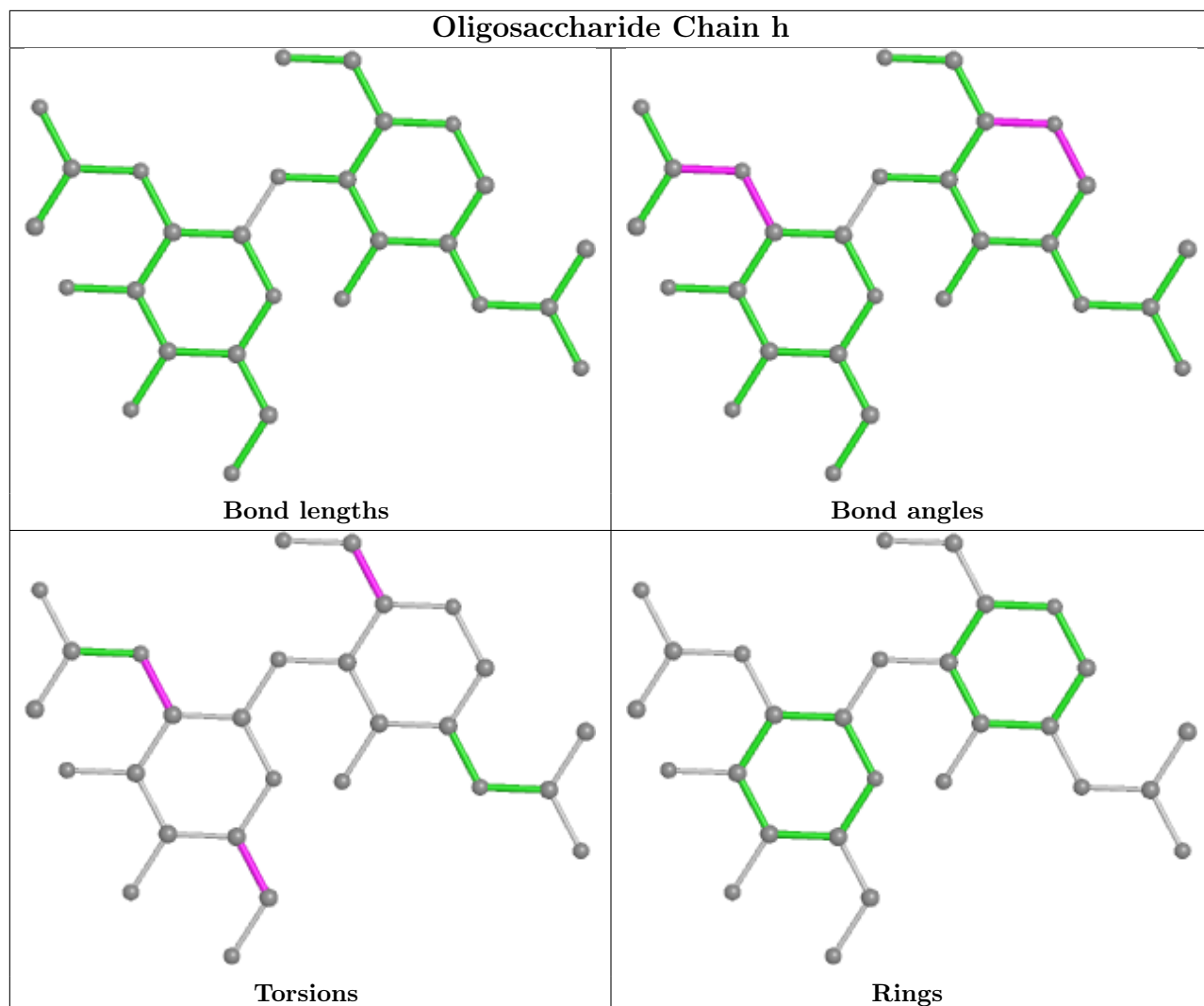

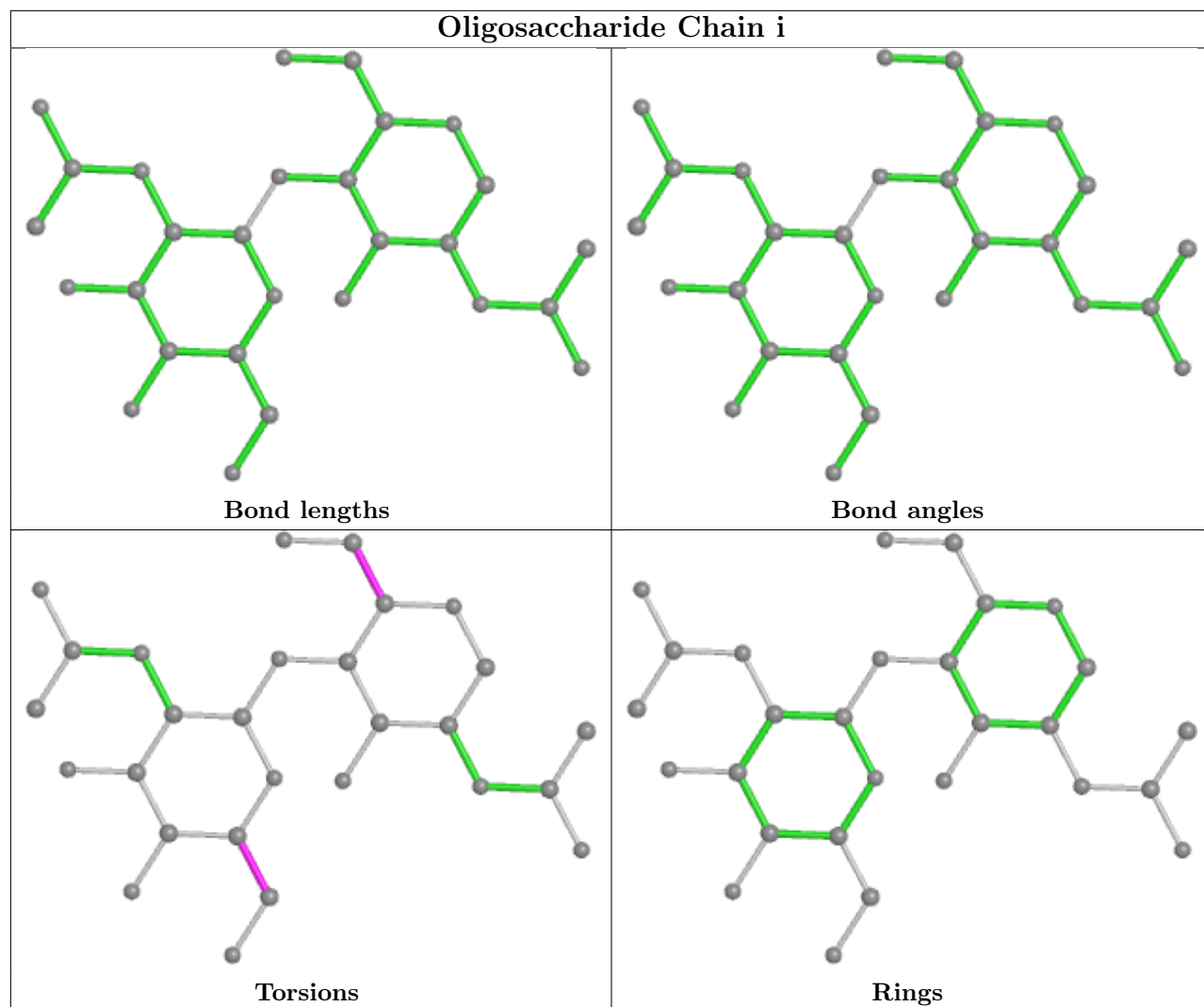

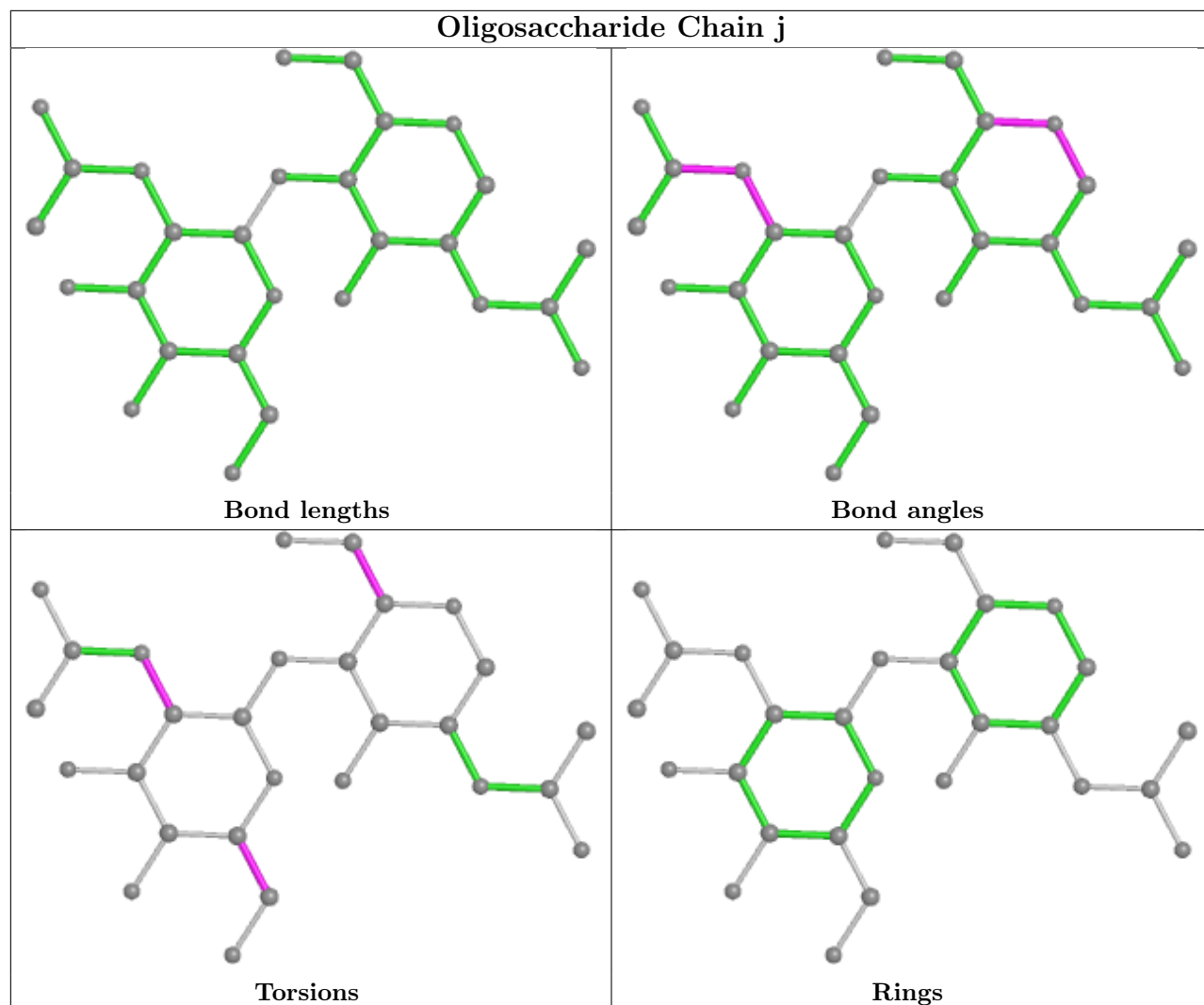

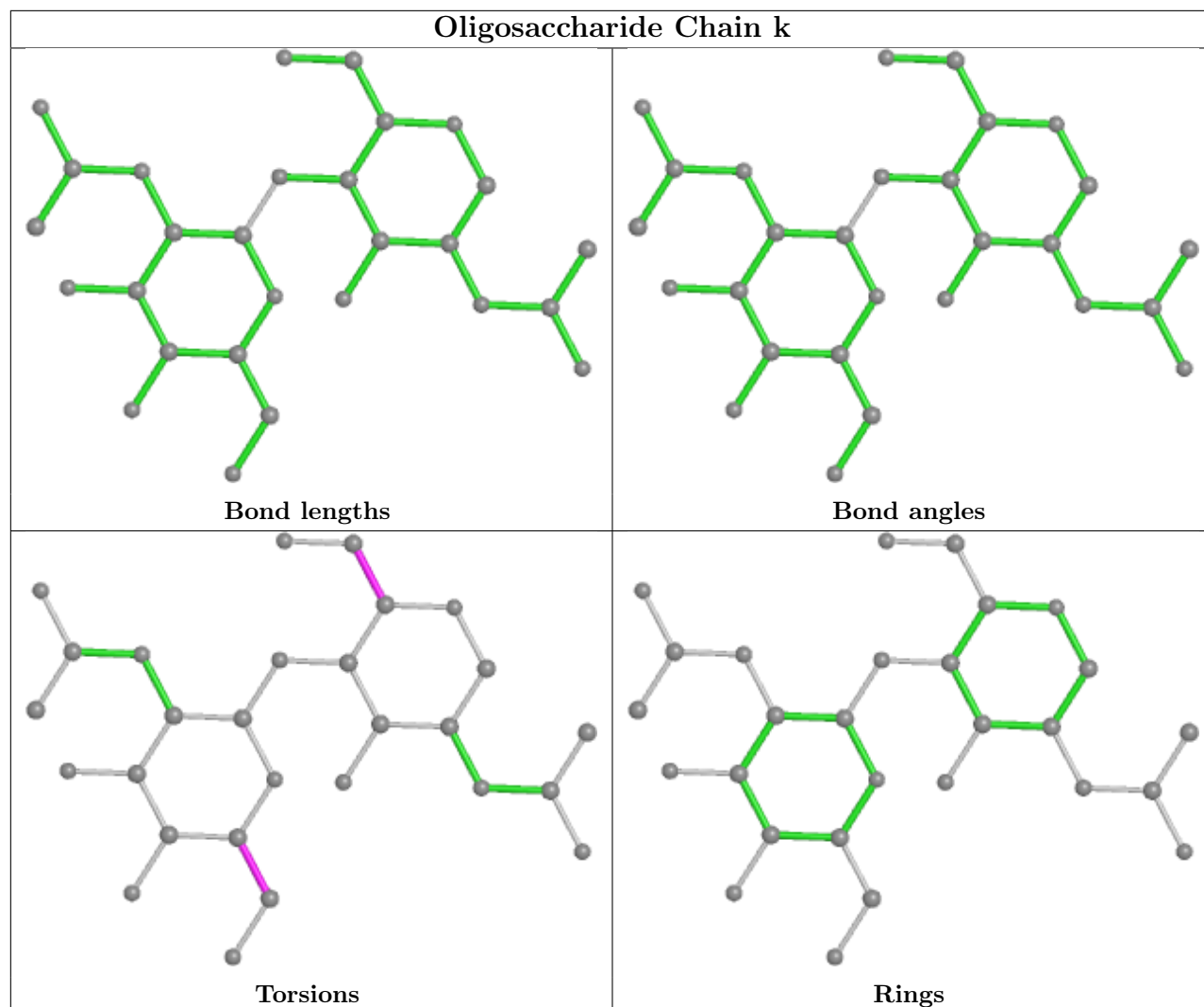

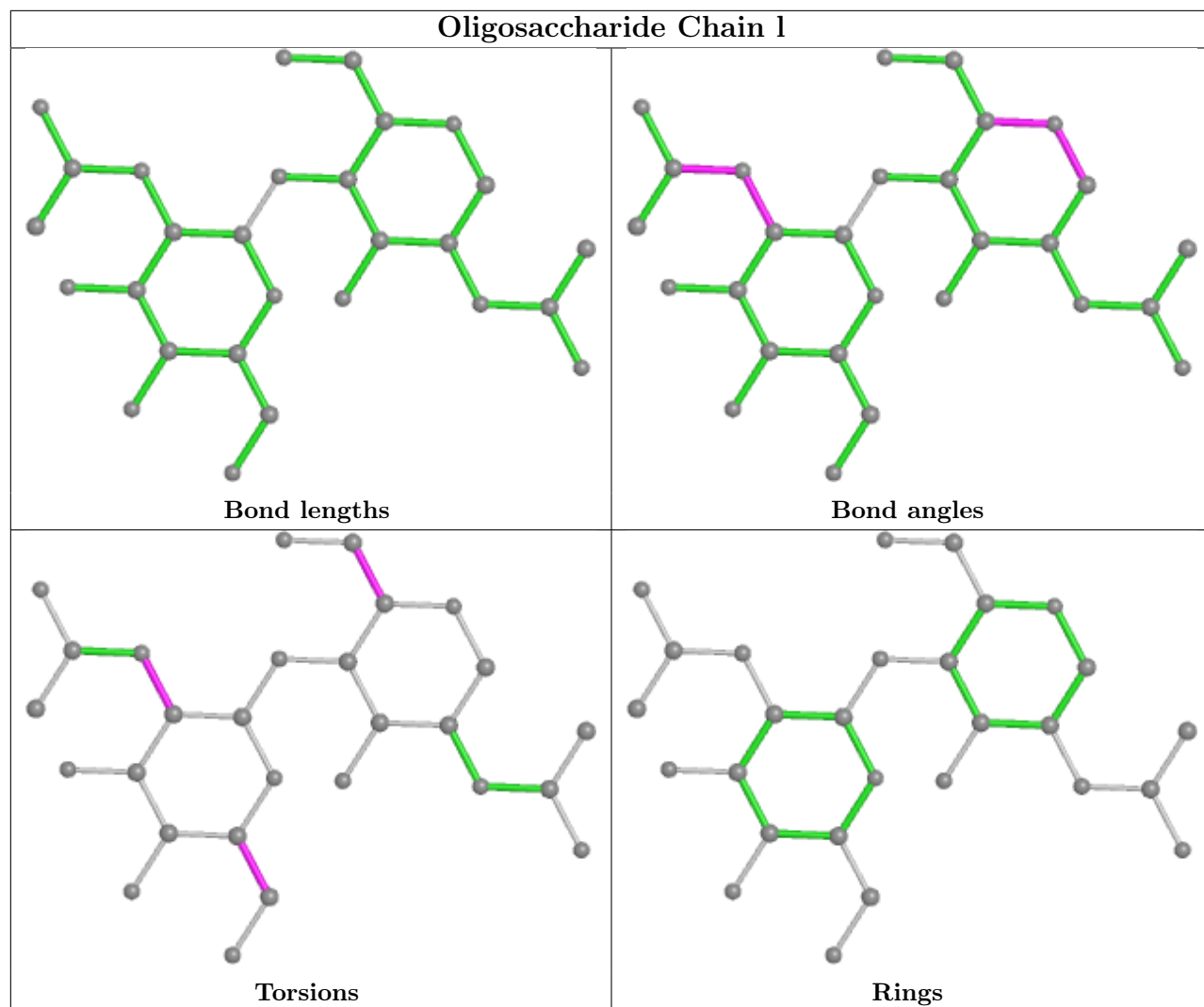

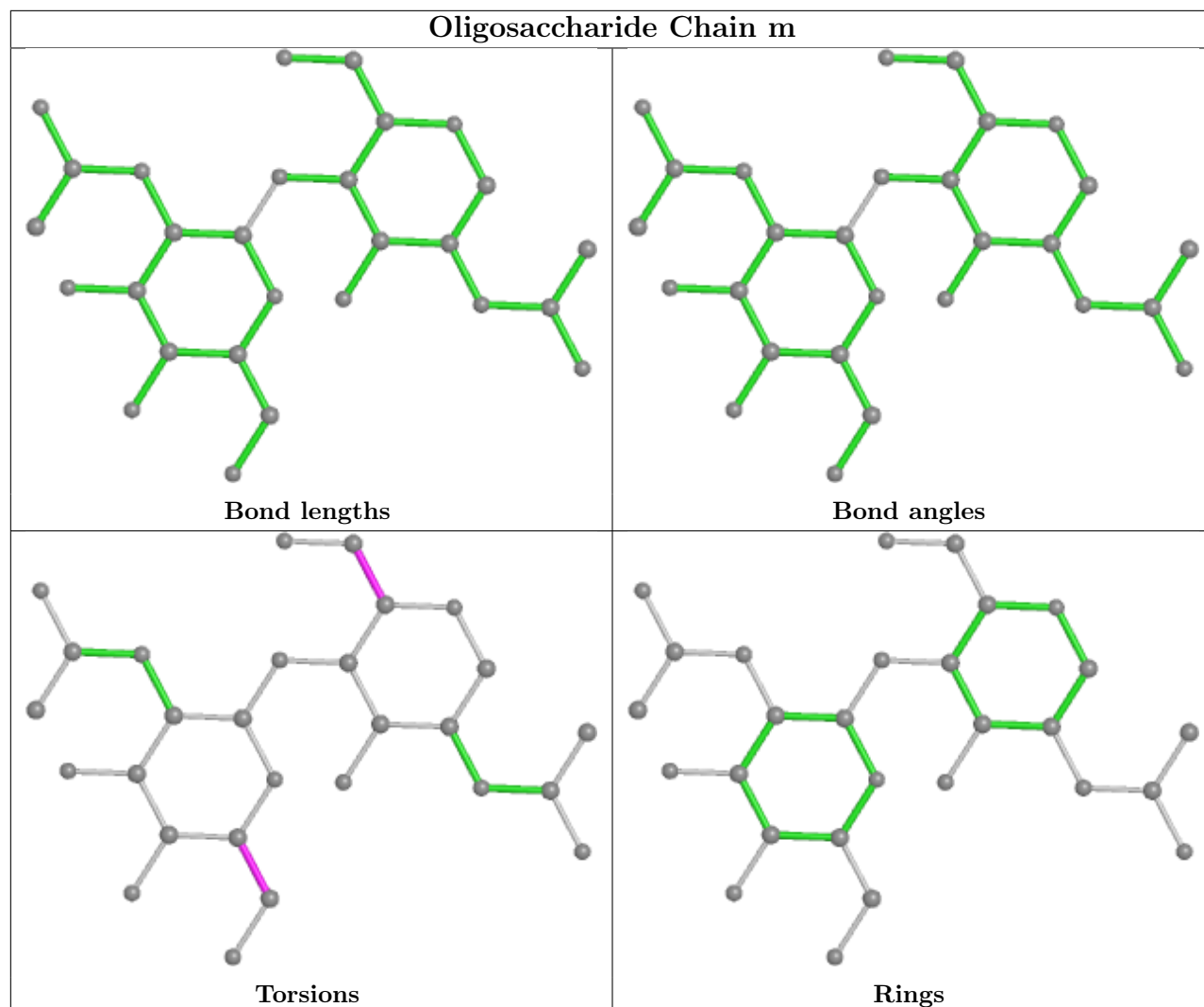

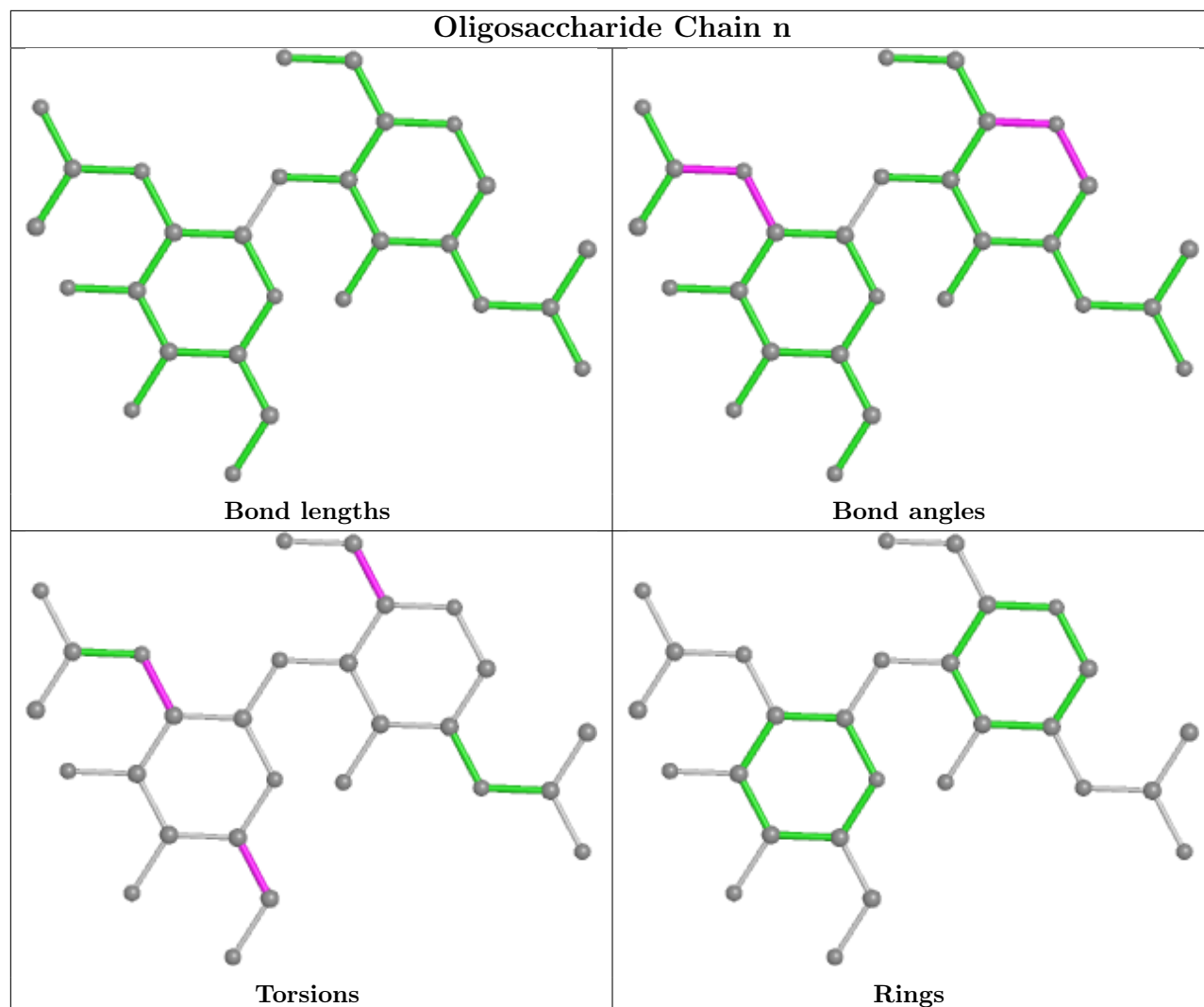

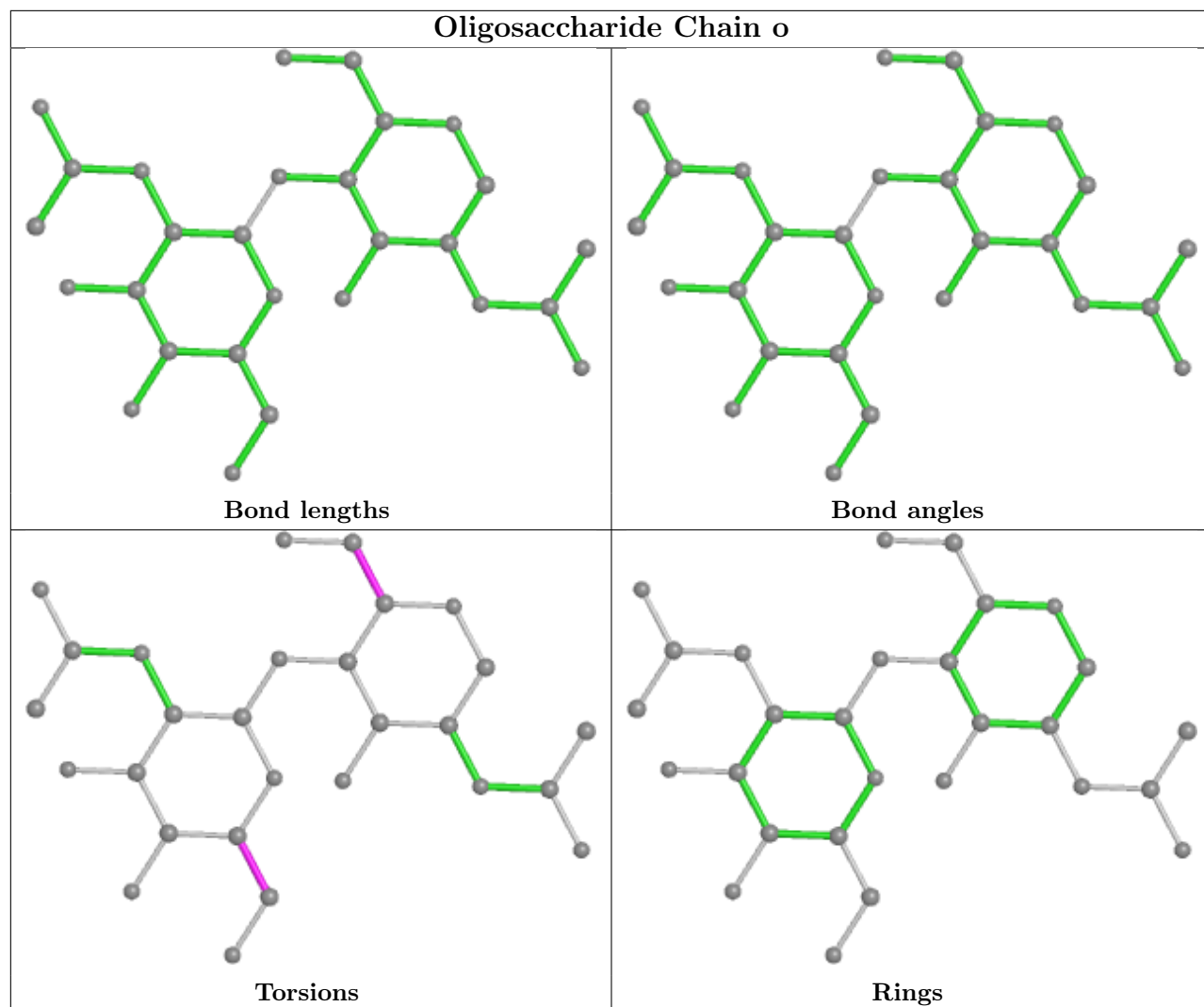

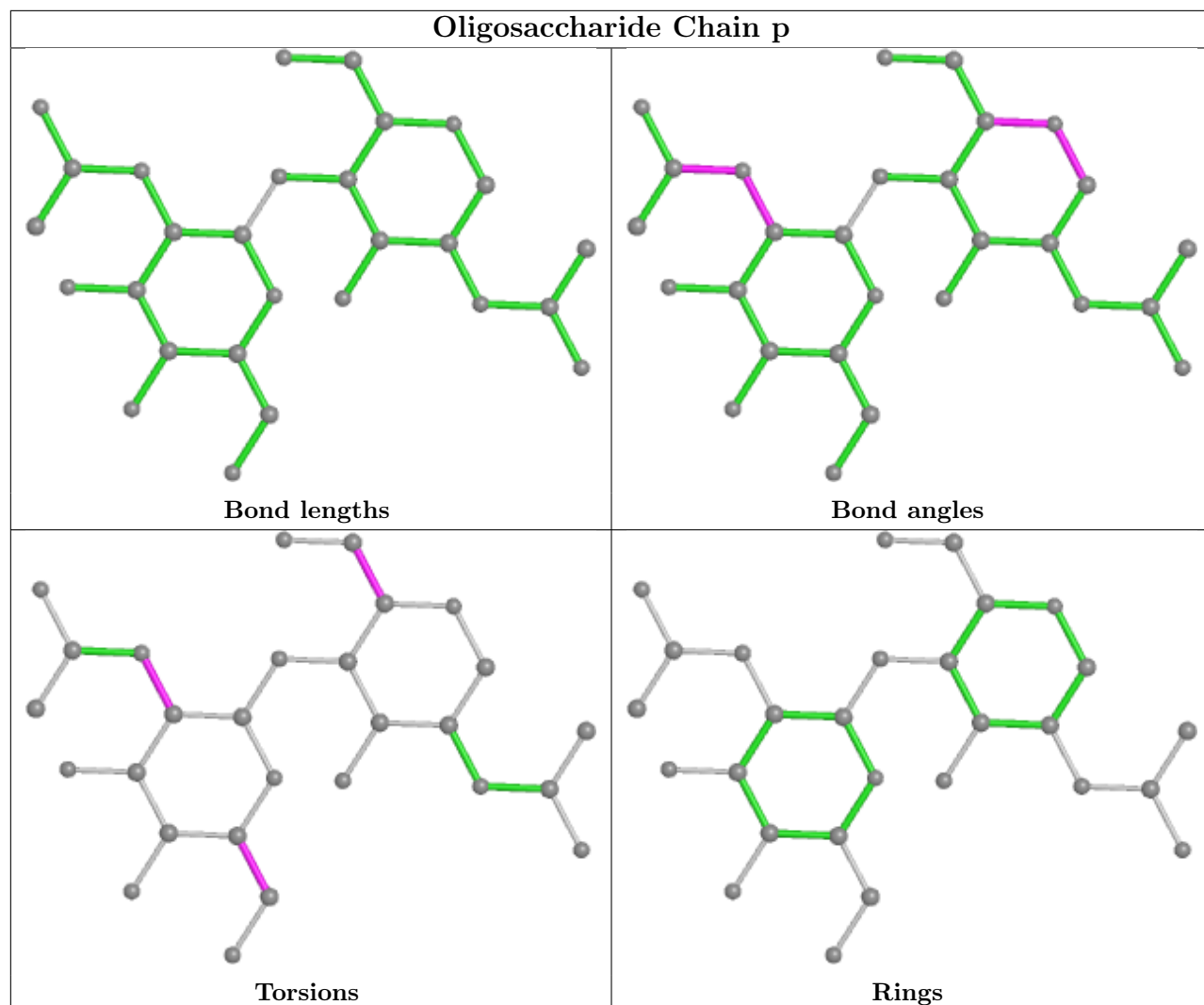

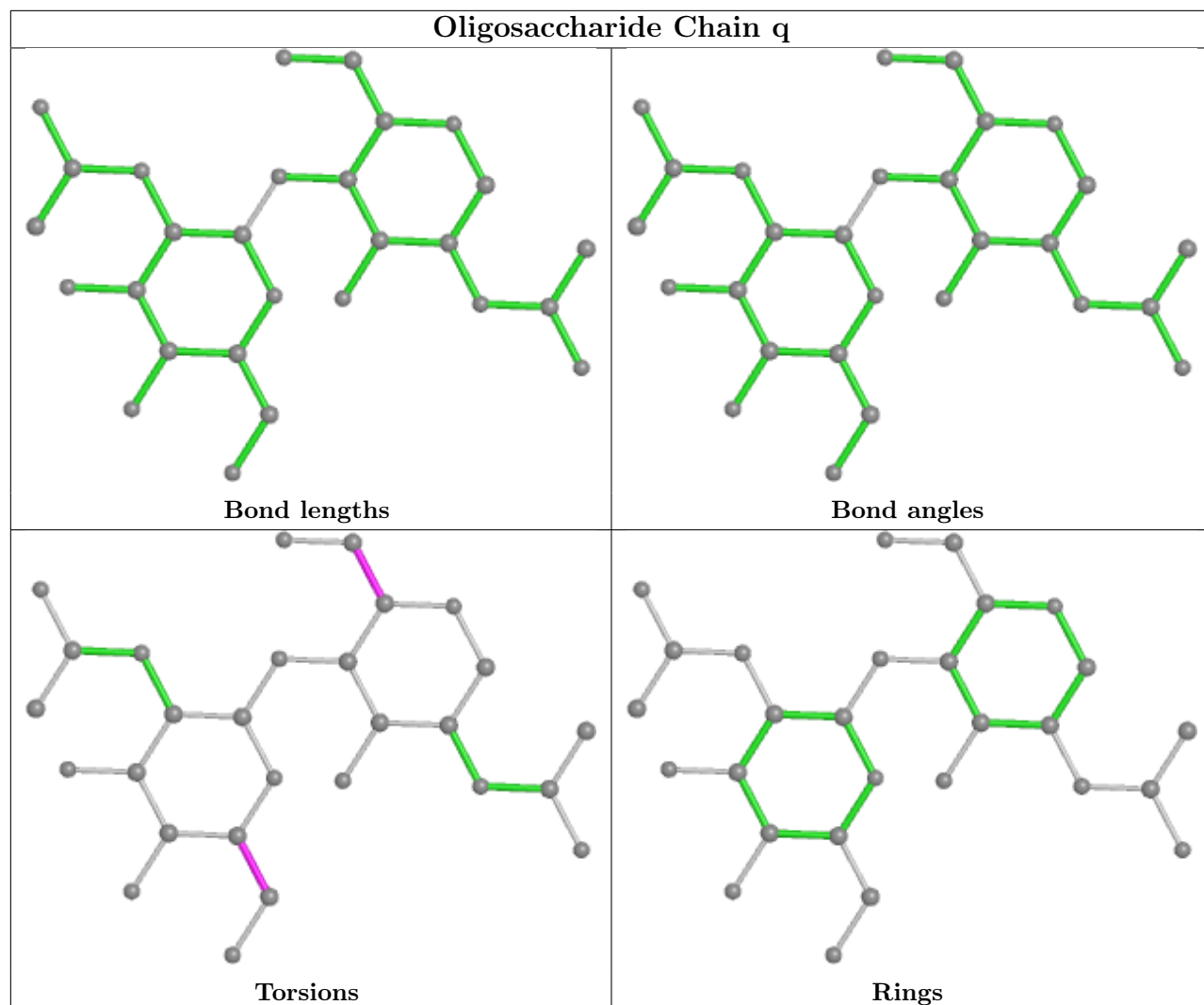

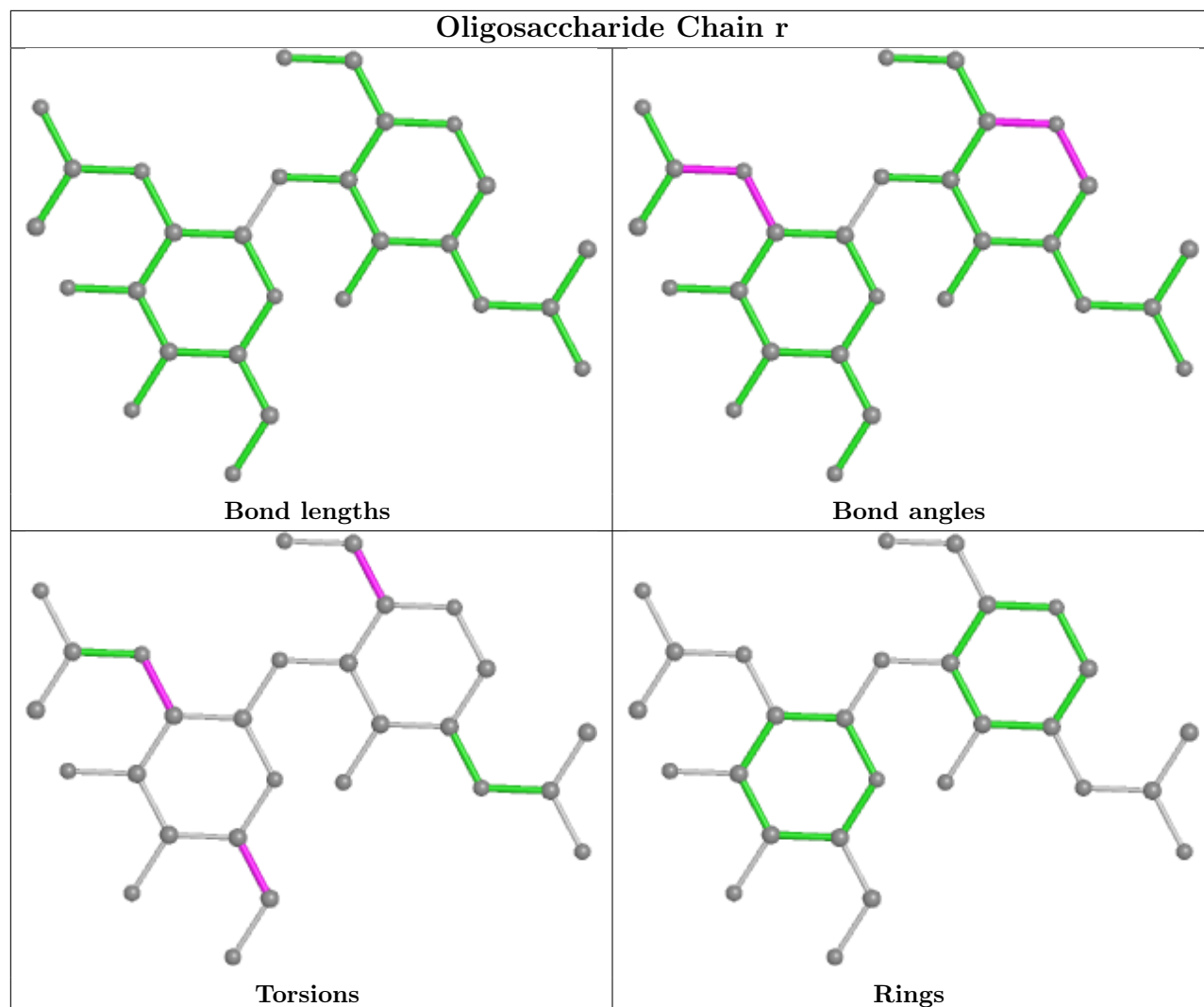

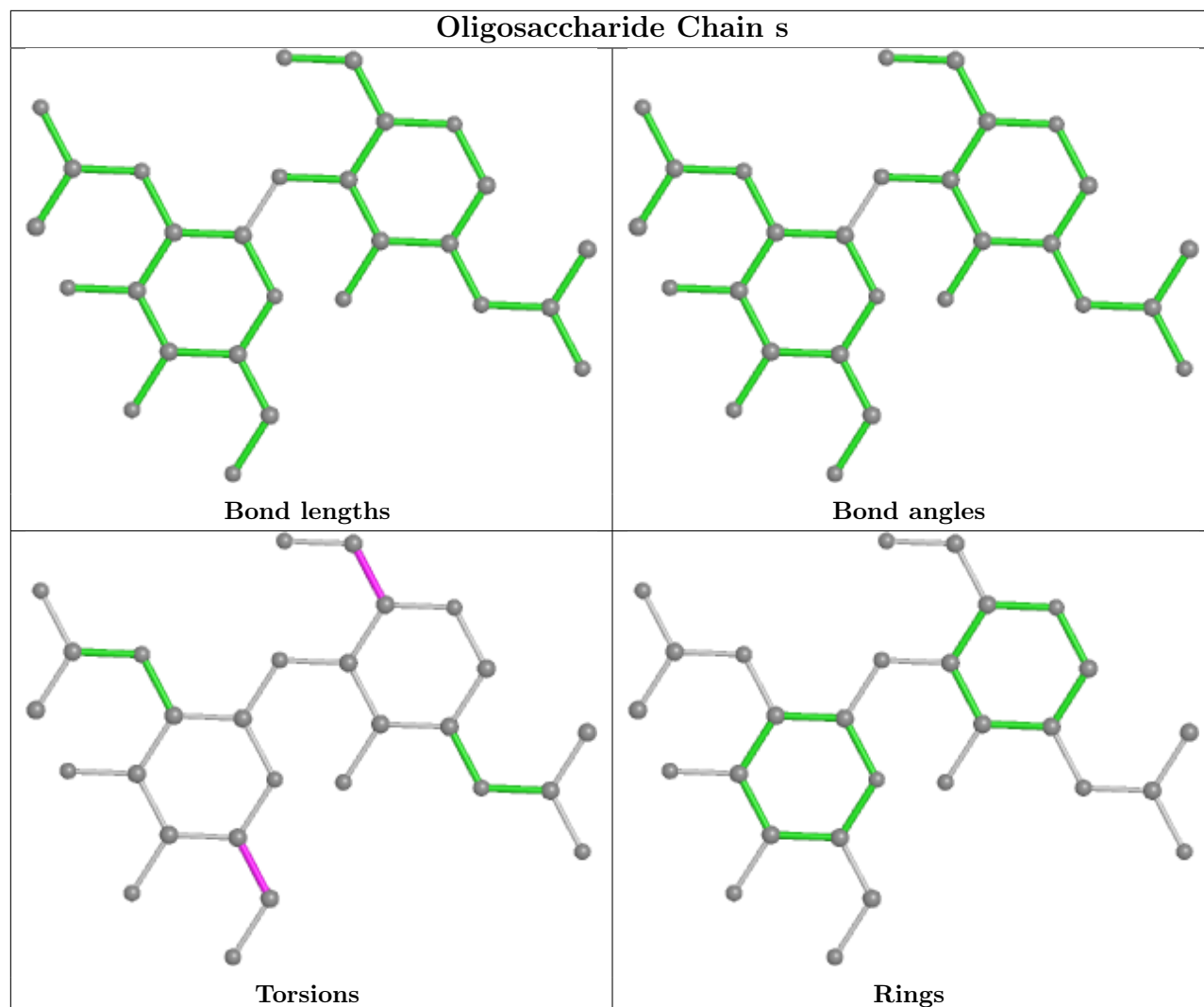

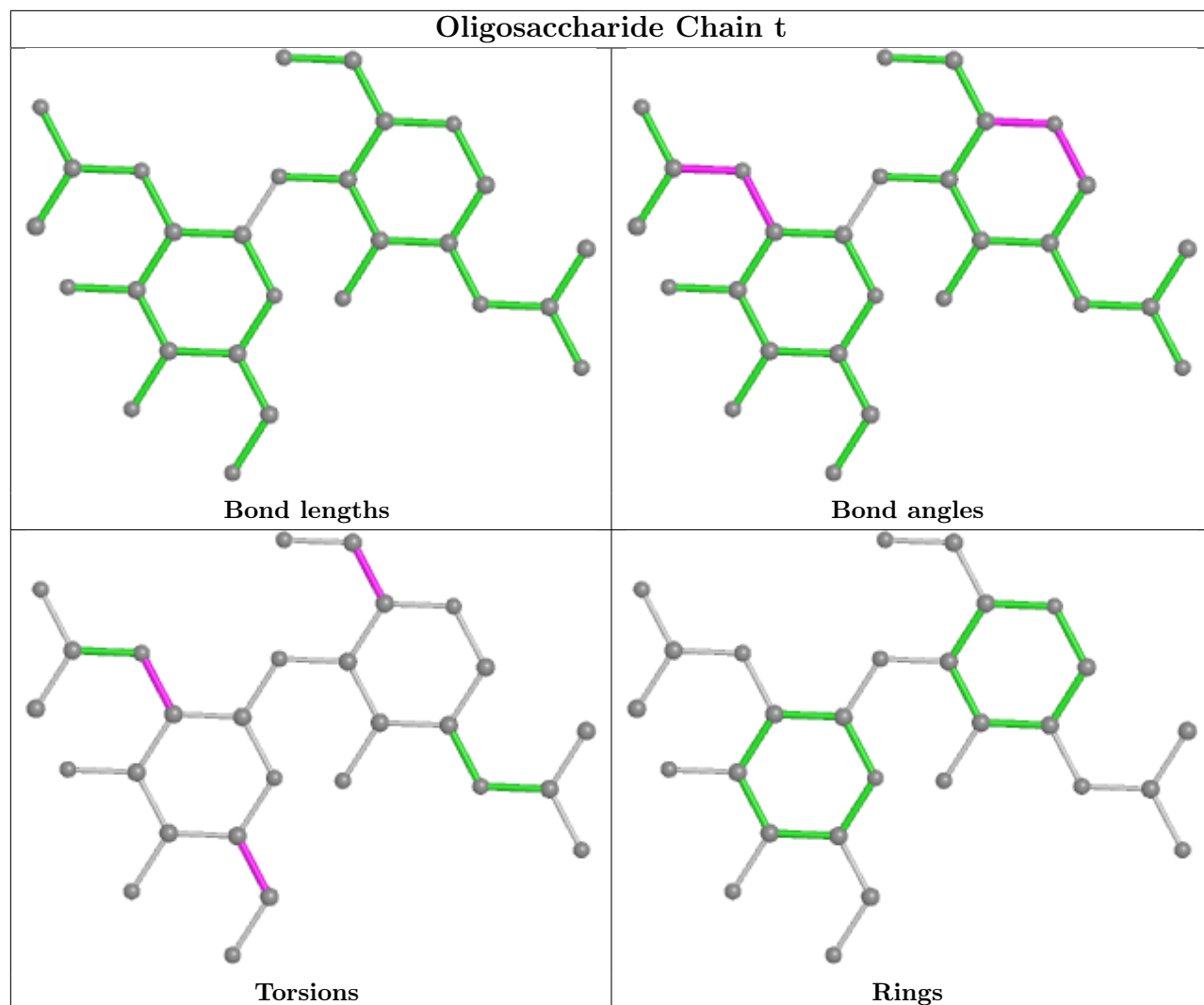

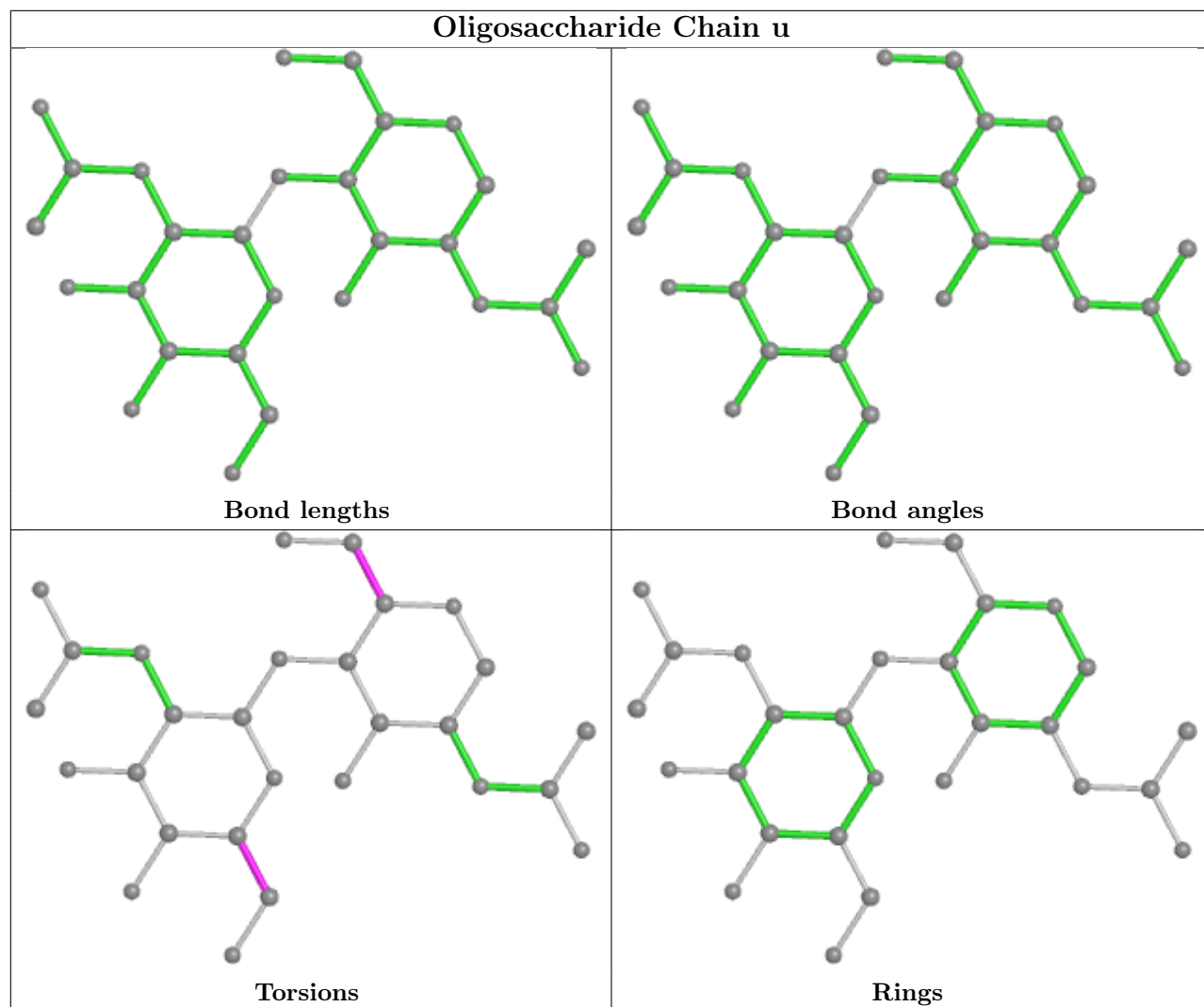

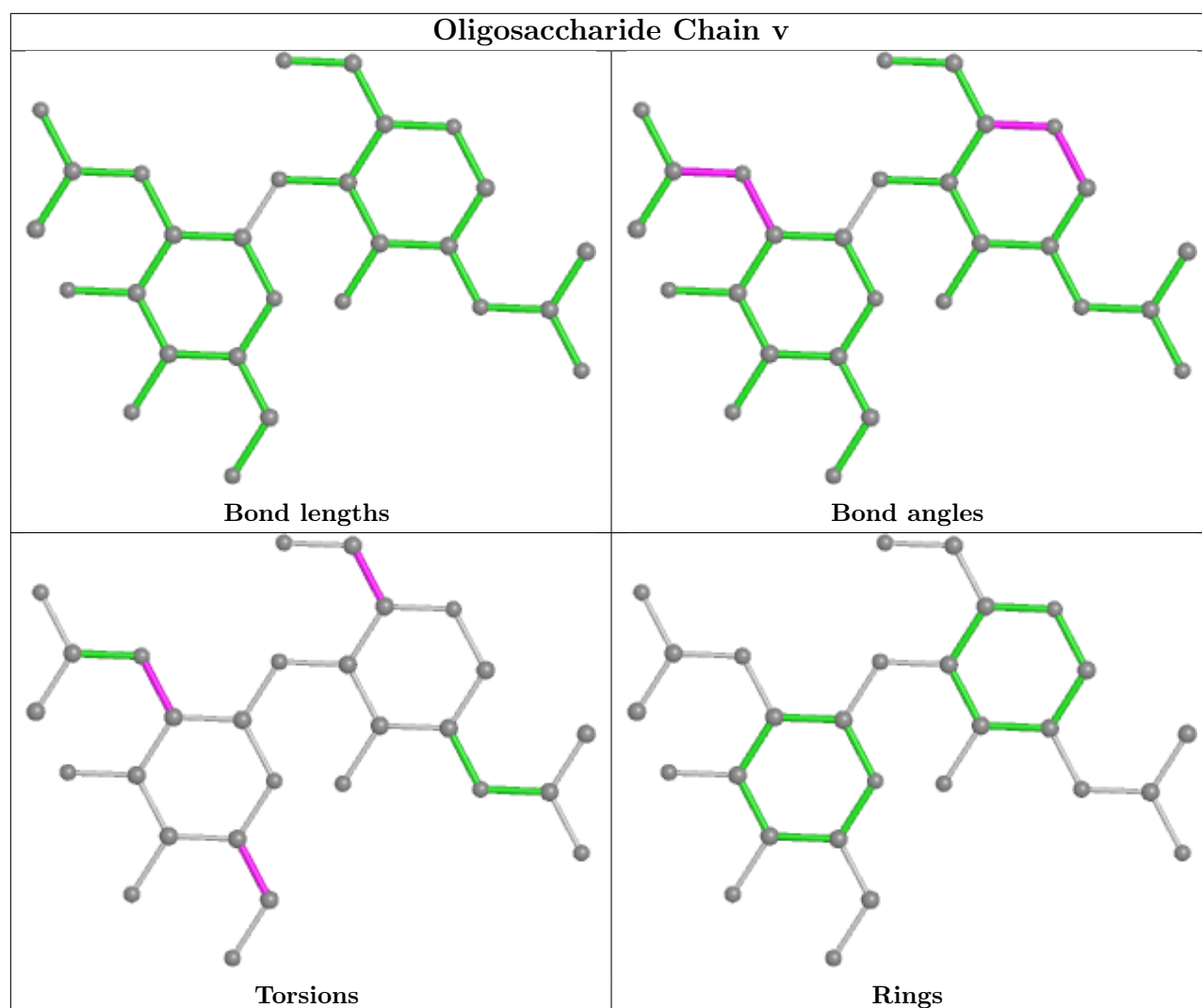

5.6 Ligand geometry [i](#)

There are no ligands in this entry.

5.7 Other polymers [i](#)

There are no such residues in this entry.

5.8 Polymer linkage issues [i](#)

There are no chain breaks in this entry.

6 Map visualisation [i](#)

This section contains visualisations of the EMDB entry EMD-20616. These allow visual inspection of the internal detail of the map and identification of artifacts.

Images derived from a raw map, generated by summing the deposited half-maps, are presented below the corresponding image components of the primary map to allow further visual inspection and comparison with those of the primary map.

6.1 Orthogonal projections [i](#)

6.1.1 Primary map

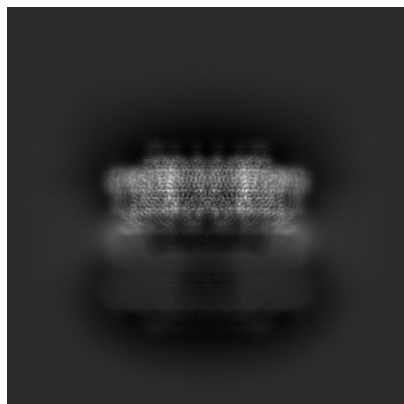

X

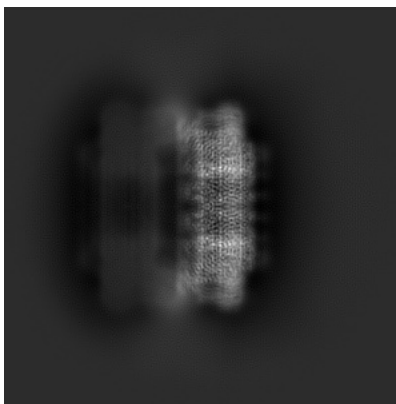

Y

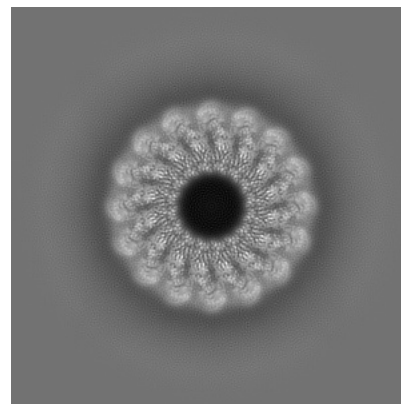

Z

6.1.2 Raw map

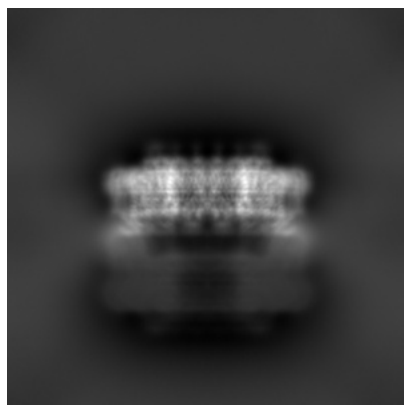

X

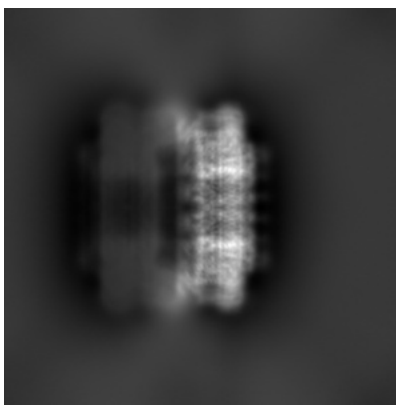

Y

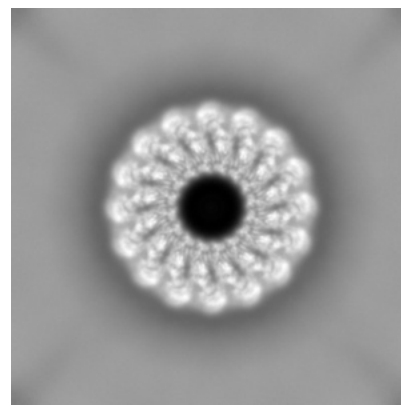

Z

The images above show the map projected in three orthogonal directions.

6.2 Central slices [i](#)

6.2.1 Primary map

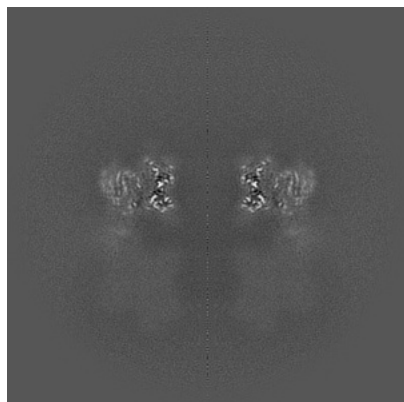

X Index: 200

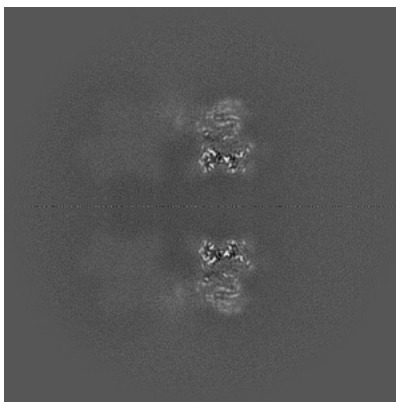

Y Index: 200

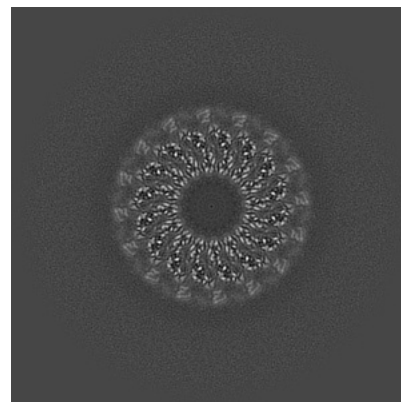

Z Index: 200

6.2.2 Raw map

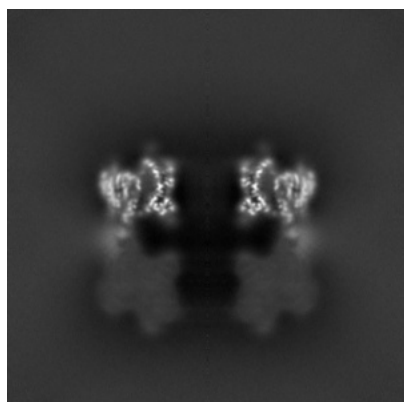

X Index: 200

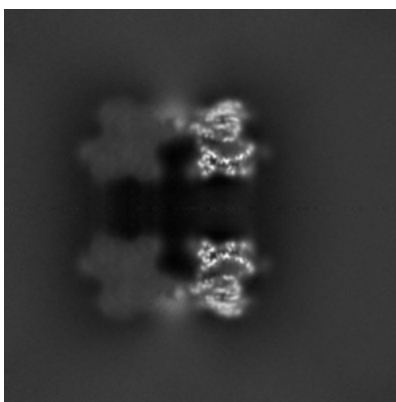

Y Index: 200

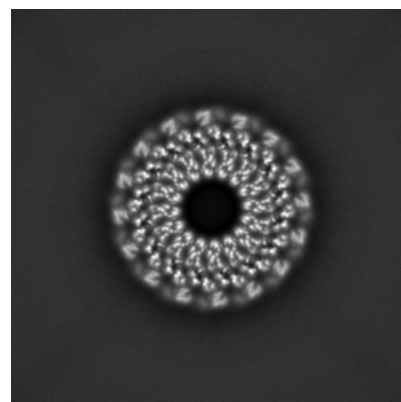

Z Index: 200

The images above show central slices of the map in three orthogonal directions.

6.3 Largest variance slices [i](#)

6.3.1 Primary map

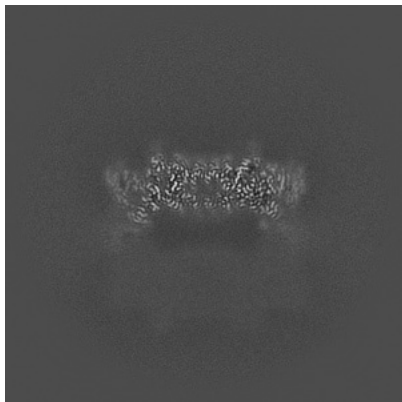

X Index: 236

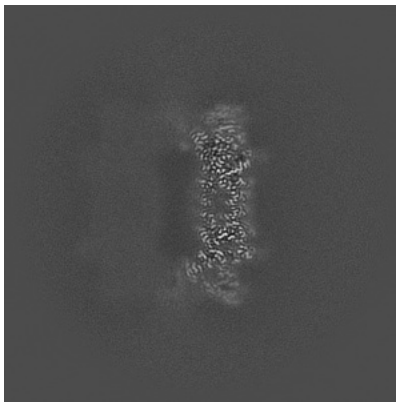

Y Index: 164

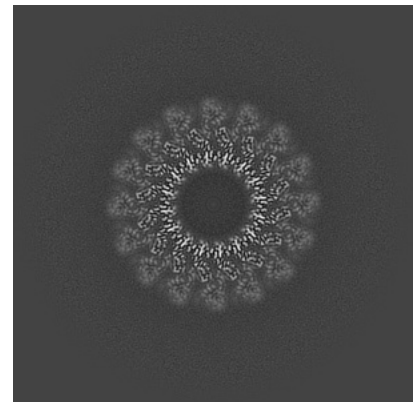

Z Index: 216

6.3.2 Raw map

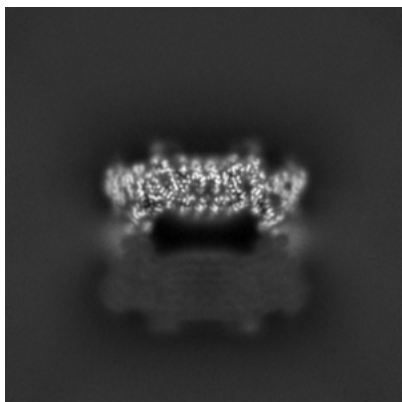

X Index: 163

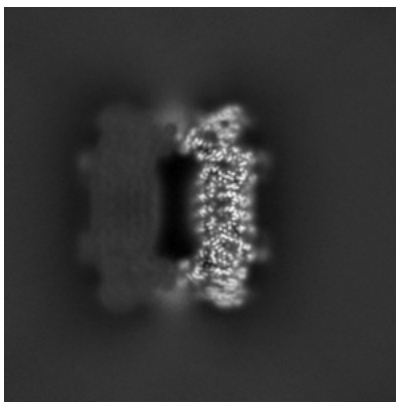

Y Index: 237

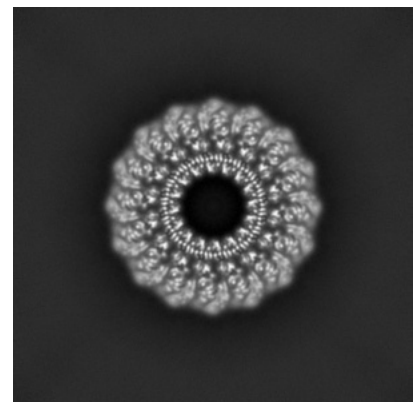

Z Index: 226

The images above show the largest variance slices of the map in three orthogonal directions.

6.4 Orthogonal surface views [i](#)

6.4.1 Primary map

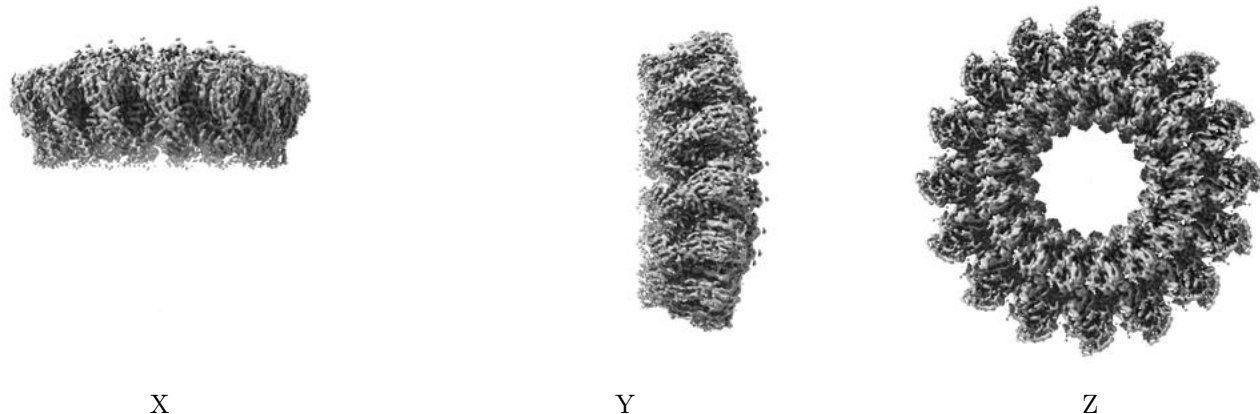

The images above show the 3D surface view of the map at the recommended contour level 1.0. These images, in conjunction with the slice images, may facilitate assessment of whether an appropriate contour level has been provided.

6.4.2 Raw map

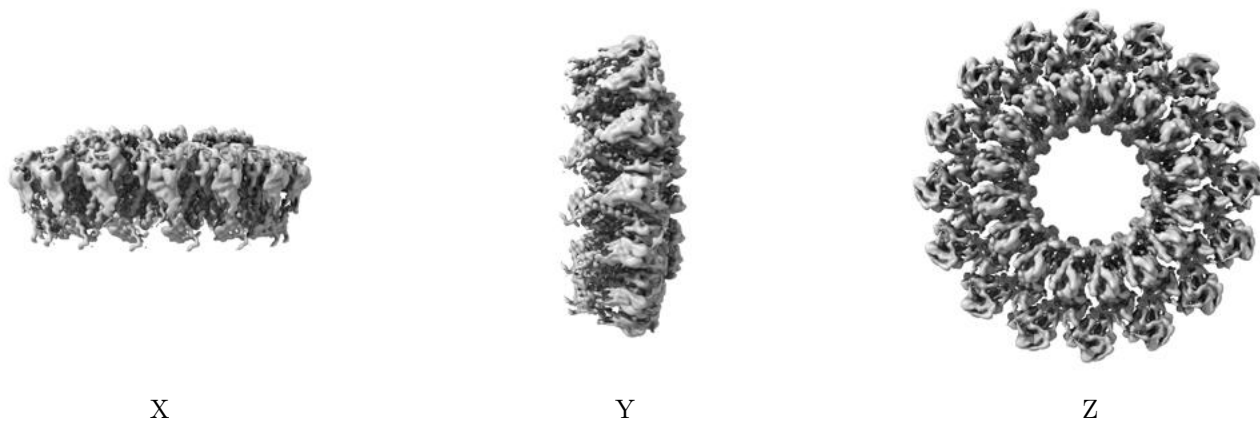

These images show the 3D surface of the raw map. The raw map's contour level was selected so that its surface encloses the same volume as the primary map does at its recommended contour level.

6.5 Mask visualisation [i](#)

This section shows the 3D surface view of the primary map at 50% transparency overlaid with the specified mask at 0% transparency

A mask typically either:

- Encompasses the whole structure
- Separates out a domain, a functional unit, a monomer or an area of interest from a larger structure

6.5.1 emd_20616_msk_1.map [i](#)

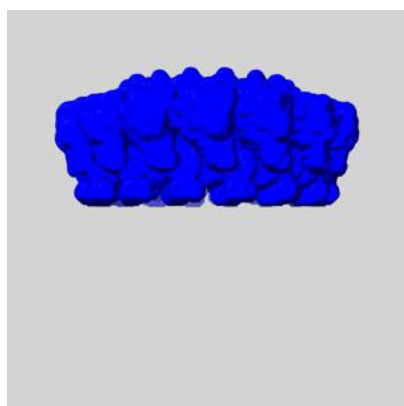

X

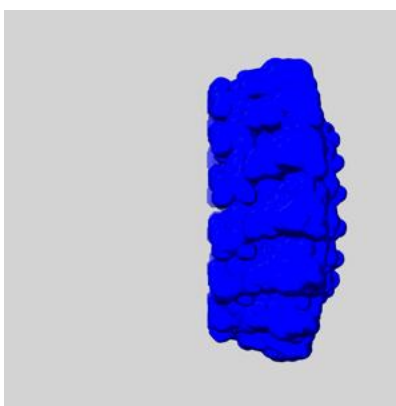

Y

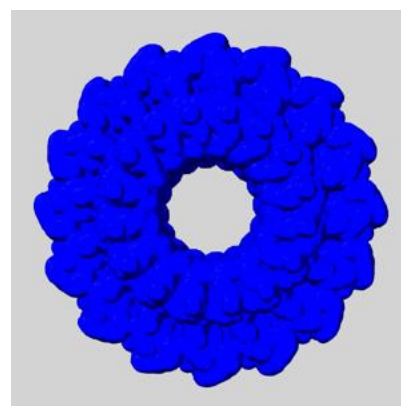

Z

7 Map analysis [i](#)

This section contains the results of statistical analysis of the map.

7.1 Map-value distribution [i](#)

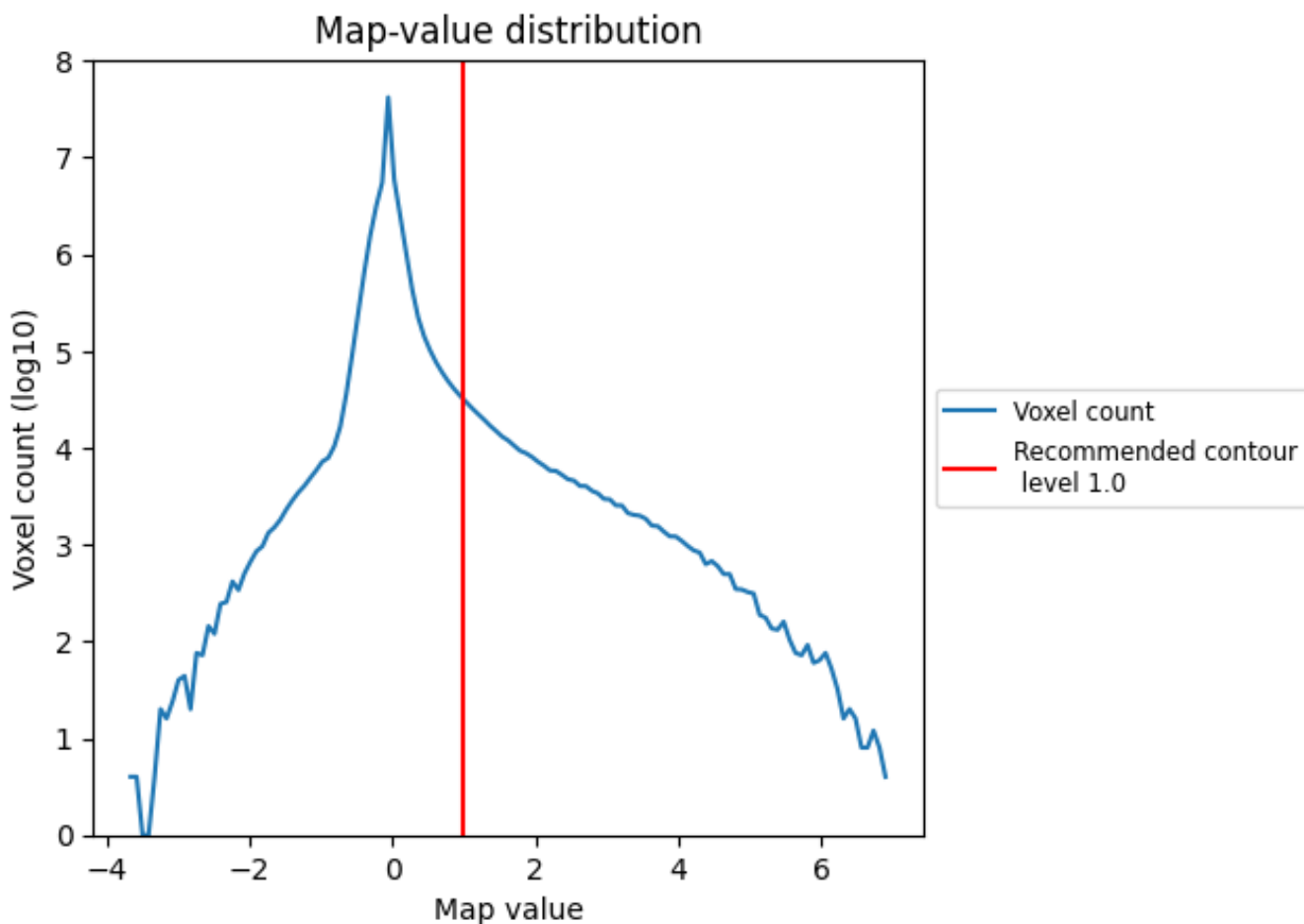

The map-value distribution is plotted in 128 intervals along the x-axis. The y-axis is logarithmic. A spike in this graph at zero usually indicates that the volume has been masked.

7.2 Volume estimate [i](#)

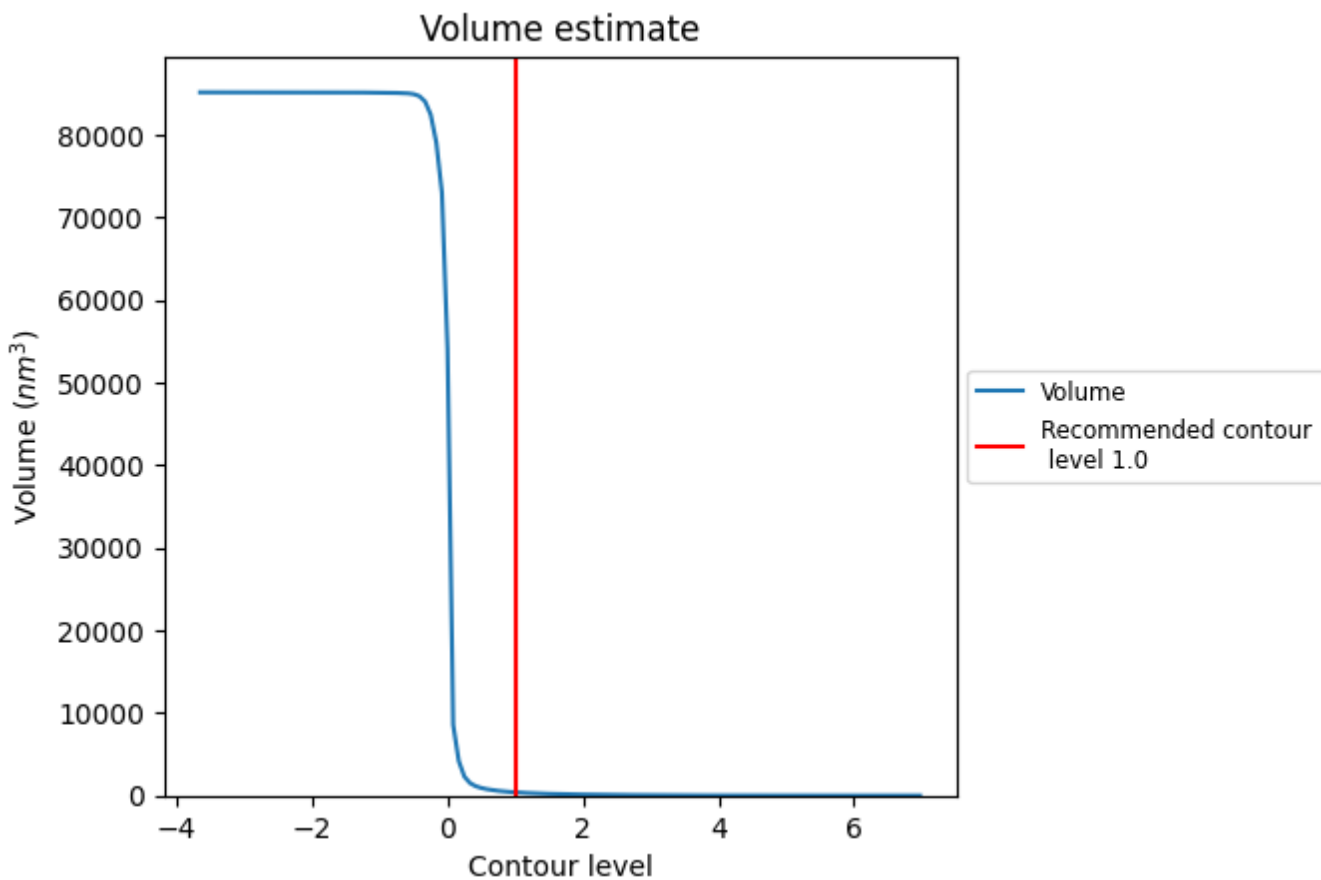

The volume at the recommended contour level is 391 nm³; this corresponds to an approximate mass of 353 kDa.

The volume estimate graph shows how the enclosed volume varies with the contour level. The recommended contour level is shown as a vertical line and the intersection between the line and the curve gives the volume of the enclosed surface at the given level.

7.3 Rotationally averaged power spectrum [i](#)

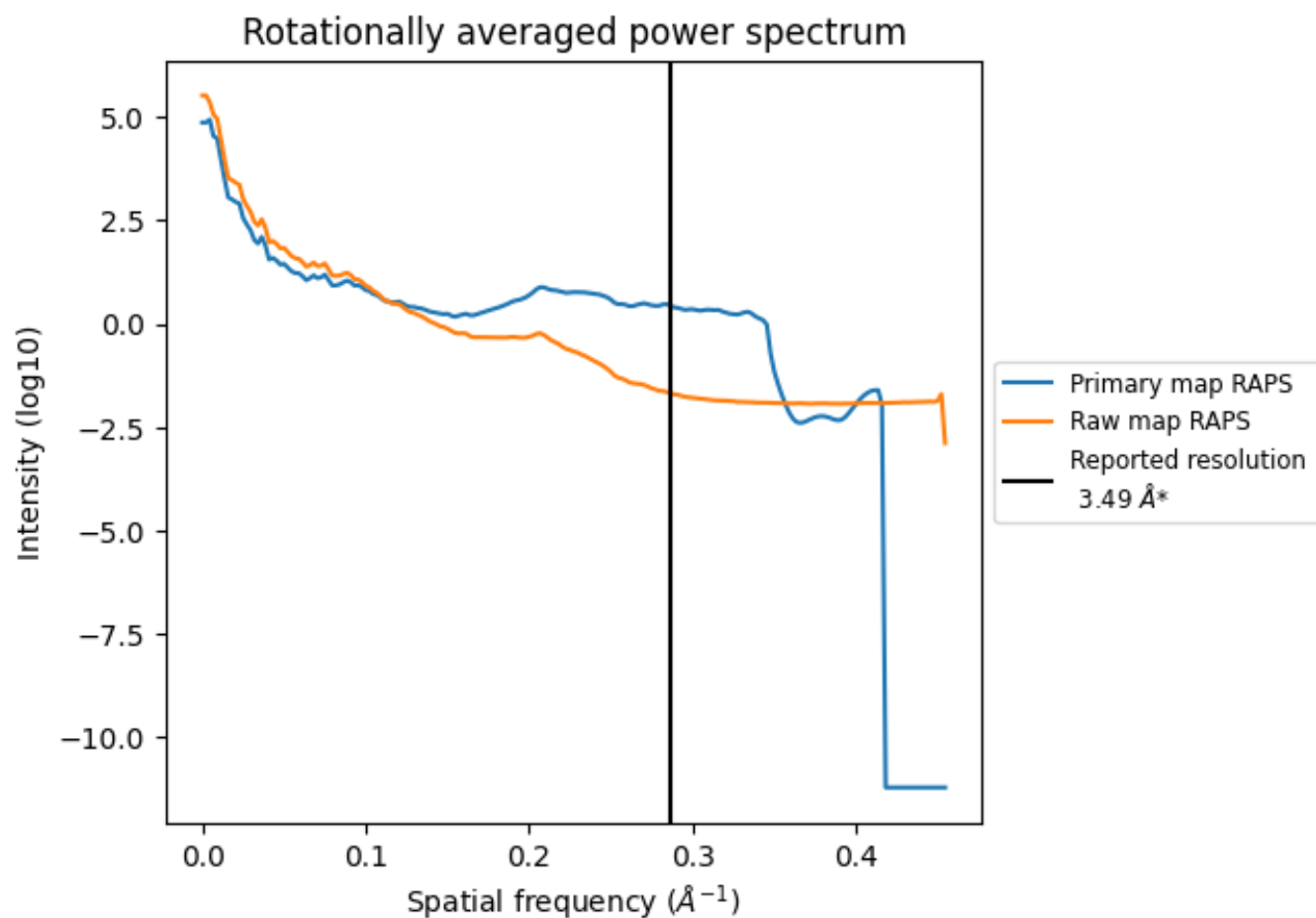

*Reported resolution corresponds to spatial frequency of 0.287\AA^{-1}

8 Fourier-Shell correlation [i](#)

Fourier-Shell Correlation (FSC) is the most commonly used method to estimate the resolution of single-particle and subtomogram-averaged maps. The shape of the curve depends on the imposed symmetry, mask and whether or not the two 3D reconstructions used were processed from a common reference. The reported resolution is shown as a black line. A curve is displayed for the half-bit criterion in addition to lines showing the 0.143 gold standard cut-off and 0.5 cut-off.

8.1 FSC [i](#)

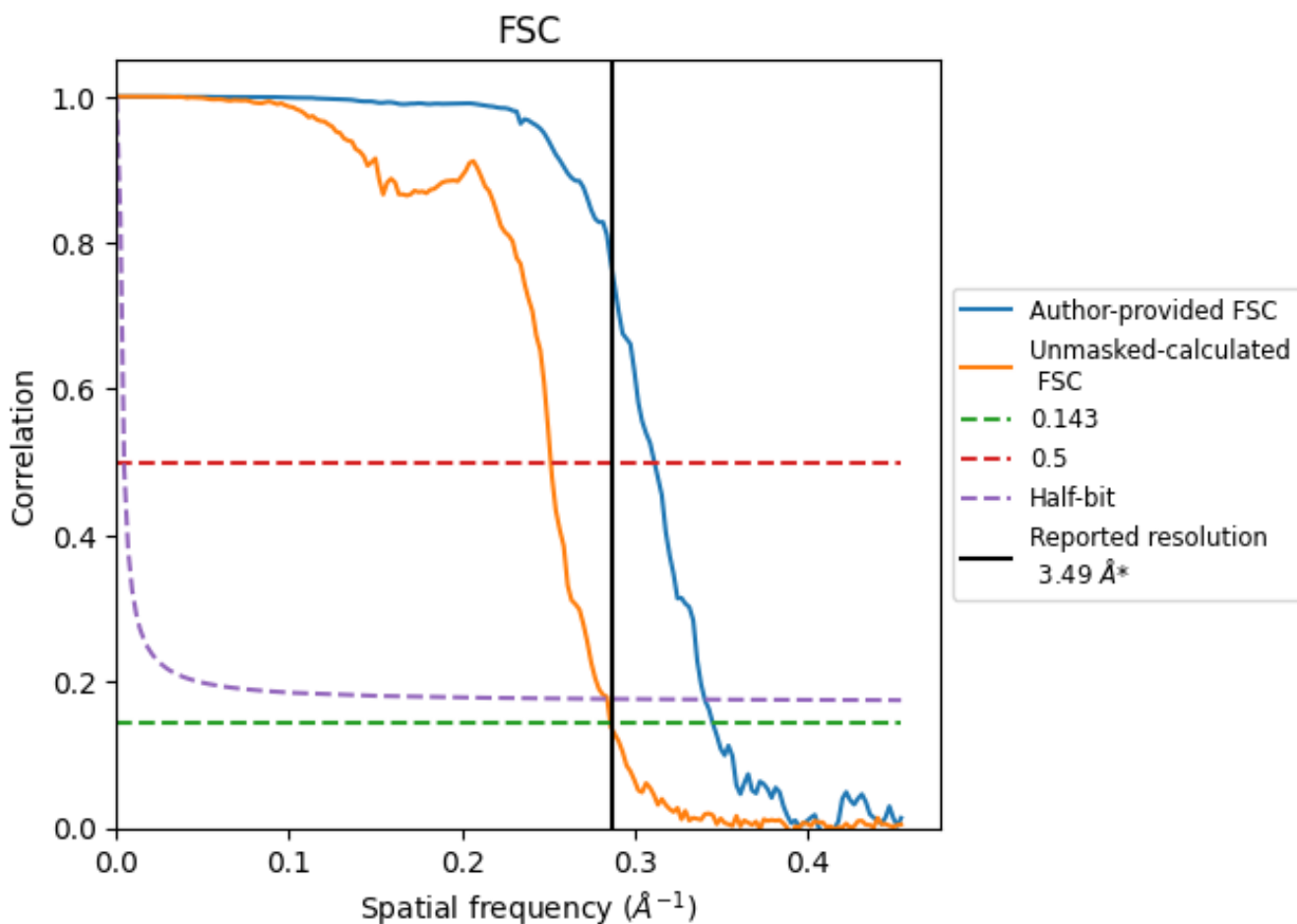

*Reported resolution corresponds to spatial frequency of 0.287 Å⁻¹

8.2 Resolution estimates [i](#)

Resolution estimate (Å)	Estimation criterion (FSC cut-off)		
	0.143	0.5	Half-bit
Reported by author	3.49	-	-
Author-provided FSC curve	2.90	3.21	2.93
Unmasked-calculated*	3.50	3.97	3.52

*Resolution estimate based on FSC curve calculated by comparison of deposited half-maps. The value from author-provided FSC intersecting FSC 0.143 CUT-OFF 2.90 differs from the reported value 3.49 by more than 10 %

9 Map-model fit [i](#)

This section contains information regarding the fit between EMDB map EMD-20616 and PDB model 6U23. Per-residue inclusion information can be found in section 3 on page 10.

9.1 Map-model overlay [i](#)

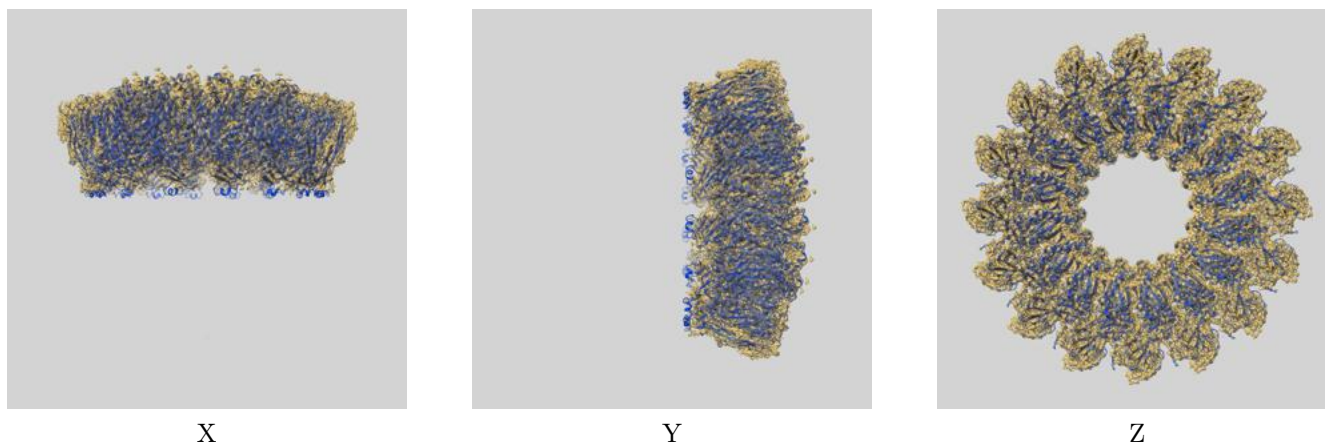

The images above show the 3D surface view of the map at the recommended contour level 1.0 at 50% transparency in yellow overlaid with a ribbon representation of the model coloured in blue. These images allow for the visual assessment of the quality of fit between the atomic model and the map.

9.2 Q-score mapped to coordinate model [i](#)

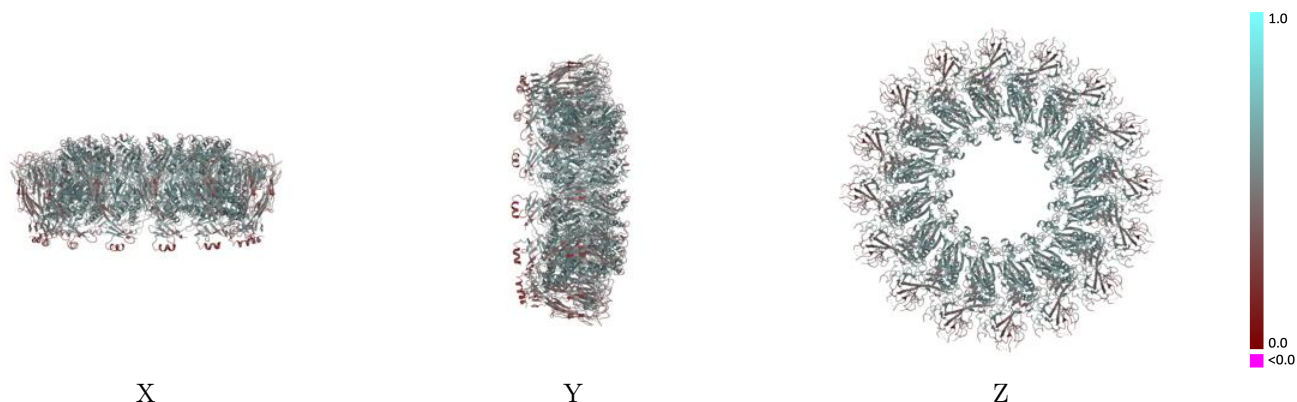

The images above show the model with each residue coloured according to its Q-score. This shows their resolvability in the map with higher Q-score values reflecting better resolvability. Please note: Q-score is calculating the resolvability of atoms, and thus high values are only expected at resolutions at which atoms can be resolved. Low Q-score values may therefore be expected for many entries.

9.3 Atom inclusion mapped to coordinate model [i](#)

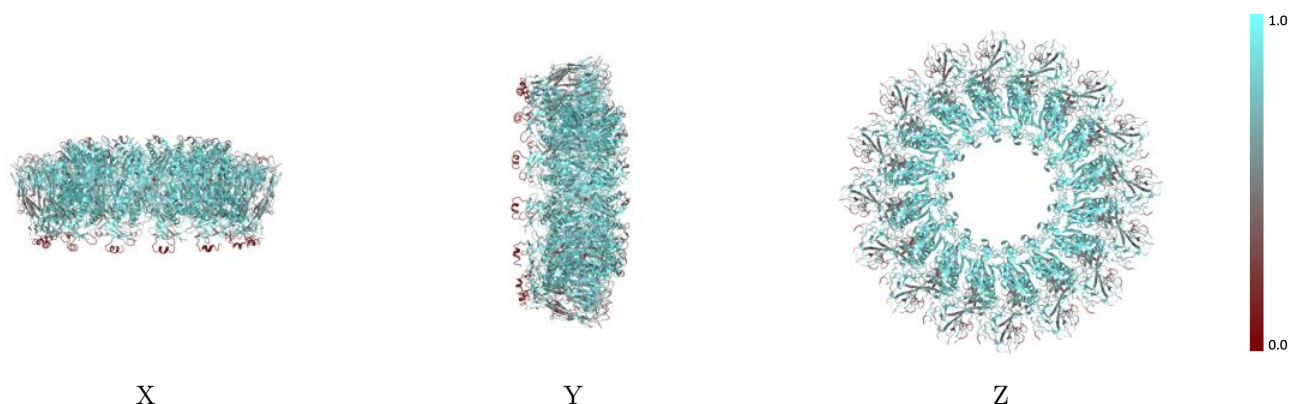

The images above show the model with each residue coloured according to its atom inclusion. This shows to what extent they are inside the map at the recommended contour level (1.0).



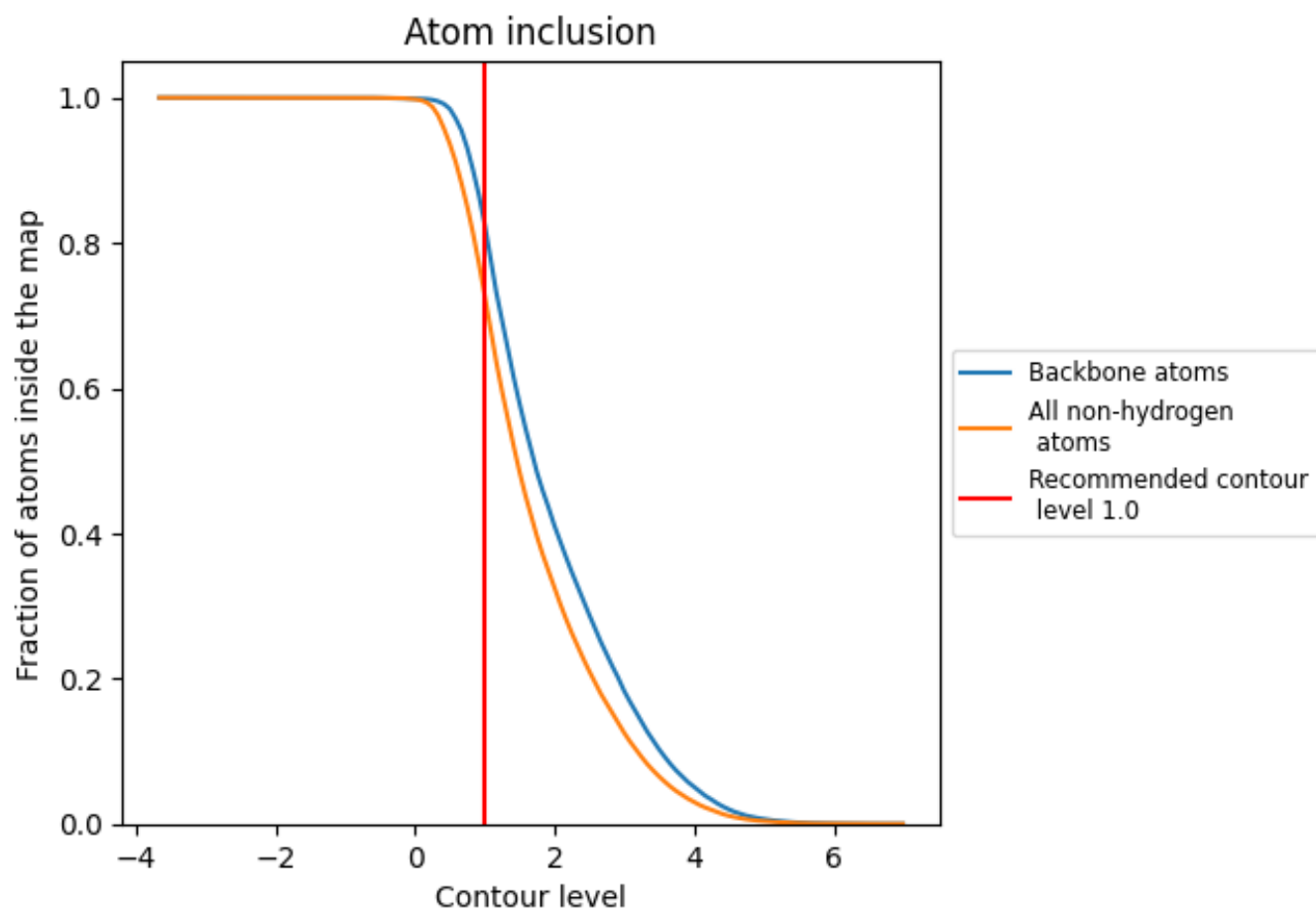



































































9.4 Atom inclusion [i](#)



At the recommended contour level, 82% of all backbone atoms, 73% of all non-hydrogen atoms, are inside the map.

9.5 Map-model fit summary

The table lists the average atom inclusion at the recommended contour level (1.0) and Q-score for the entire model and for each chain.

Chain	Atom inclusion	Q-score
All	 0.7255	 0.5000
A	 0.7420	 0.5150
B	 0.7398	 0.5130
C	 0.7429	 0.5150
D	 0.7357	 0.5110
E	 0.7371	 0.5110
F	 0.7386	 0.5100
G	 0.7402	 0.5120
H	 0.7375	 0.5110
I	 0.7183	 0.4900
J	 0.7295	 0.5020
K	 0.7295	 0.5050
L	 0.7203	 0.4990
M	 0.7243	 0.4910
N	 0.7230	 0.4870
O	 0.7250	 0.4880
P	 0.7057	 0.4700
Q	 0.2857	 0.2760
R	 0.3571	 0.3520
S	 0.3214	 0.3000
T	 0.3929	 0.3590
U	 0.2857	 0.3100
V	 0.3571	 0.3500
W	 0.2857	 0.2970
X	 0.3571	 0.3380
Y	 0.2857	 0.2960
Z	 0.3571	 0.3490
a	 0.3214	 0.3000
b	 0.3929	 0.3400
c	 0.3214	 0.3090
d	 0.3214	 0.3530
e	 0.2857	 0.2960
f	 0.3214	 0.3370
g	 0.2500	 0.2410
h	 0.3214	 0.3190



Continued on next page...

Continued from previous page...

Chain	Atom inclusion	Q-score
i	0.3214	0.2680
j	0.3571	0.3360
k	0.2500	0.2920
l	0.3929	0.3340
m	0.2857	0.3170
n	0.3571	0.3400
o	0.3214	0.2440
p	0.3214	0.3450
q	0.2857	0.2480
r	0.3571	0.3240
s	0.2857	0.2420
t	0.3214	0.3470
u	0.2500	0.2310
v	0.3571	0.3500