



wwPDB X-ray Structure Validation Summary Report ⓘ

Aug 9, 2020 – 07:05 AM BST

PDB ID : 6KAK
Title : Crystal structure of FKRP in complex with Mg ion
Authors : Kuwabara, N.
Deposited on : 2019-06-23
Resolution : 2.06 Å(reported)

This is a wwPDB X-ray Structure Validation Summary Report for a publicly released PDB entry.

We welcome your comments at validation@mail.wwpdb.org

A user guide is available at

<https://www.wwpdb.org/validation/2017/XrayValidationReportHelp>

with specific help available everywhere you see the ⓘ symbol.

The following versions of software and data (see [references ⓘ](#)) were used in the production of this report:

MolProbity : 4.02b-467
Mogul : 1.8.5 (274361), CSD as541be (2020)
Xtriage (Phenix) : 1.13
EDS : 2.13.1
buster-report : 1.1.7 (2018)
Percentile statistics : 20191225.v01 (using entries in the PDB archive December 25th 2019)
Refmac : 5.8.0158
CCP4 : 7.0.044 (Gargrove)
Ideal geometry (proteins) : Engh & Huber (2001)
Ideal geometry (DNA, RNA) : Parkinson et al. (1996)
Validation Pipeline (wwPDB-VP) : 2.13.1

1 Overall quality at a glance

The following experimental techniques were used to determine the structure:

X-RAY DIFFRACTION

The reported resolution of this entry is 2.06 Å.

Percentile scores (ranging between 0-100) for global validation metrics of the entry are shown in the following graphic. The table shows the number of entries on which the scores are based.

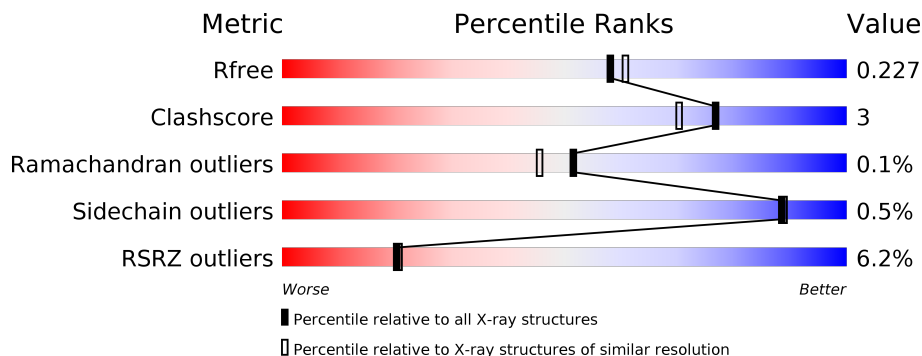

Metric	Whole archive (#Entries)	Similar resolution (#Entries, resolution range(Å))
R_{free}	130704	2684 (2.08-2.04)
Clashscore	141614	2801 (2.08-2.04)
Ramachandran outliers	138981	2768 (2.08-2.04)
Sidechain outliers	138945	2768 (2.08-2.04)
RSRZ outliers	127900	2646 (2.08-2.04)

The table below summarises the geometric issues observed across the polymeric chains and their fit to the electron density. The red, orange, yellow and green segments on the lower bar indicate the fraction of residues that contain outliers for ≥ 3 , 2, 1 and 0 types of geometric quality criteria respectively. A grey segment represents the fraction of residues that are not modelled. The numeric value for each fraction is indicated below the corresponding segment, with a dot representing fractions $\leq 5\%$. The upper red bar (where present) indicates the fraction of residues that have poor fit to the electron density. The numeric value is given above the bar.

Mol	Chain	Length	Quality of chain
1	A	455	
1	B	455	
1	C	455	
1	D	455	

The following table lists non-polymeric compounds, carbohydrate monomers and non-standard residues in protein, DNA, RNA chains that are outliers for geometric or electron-density-fit crite-

ria:

Mol	Type	Chain	Res	Chirality	Geometry	Clashes	Electron density
4	MG	A	505	-	-	-	X

2 Entry composition i

There are 5 unique types of molecules in this entry. The entry contains 14589 atoms, of which 0 are hydrogens and 0 are deuteriums.

In the tables below, the ZeroOcc column contains the number of atoms modelled with zero occupancy, the AltConf column contains the number of residues with at least one atom in alternate conformation and the Trace column contains the number of residues modelled with at most 2 atoms.

- Molecule 1 is a protein called Fukutin-related protein.

Mol	Chain	Residues	Atoms					ZeroOcc	AltConf	Trace
			Total	C	N	O	S			
1	A	443	Total 3416	C 2191	N 606	O 610	S 9	0	0	0
1	B	439	Total 3379	C 2170	N 593	O 607	S 9	0	0	0
1	C	441	Total 3410	C 2190	N 602	O 609	S 9	0	0	0
1	D	430	Total 3318	C 2128	N 584	O 597	S 9	0	1	0

There are 16 discrepancies between the modelled and reference sequences:

Chain	Residue	Modelled	Actual	Comment	Reference
A	41	GLY	-	expression tag	UNP Q9H9S5
A	42	GLY	-	expression tag	UNP Q9H9S5
A	43	ARG	-	expression tag	UNP Q9H9S5
A	44	PRO	-	expression tag	UNP Q9H9S5
B	41	GLY	-	expression tag	UNP Q9H9S5
B	42	GLY	-	expression tag	UNP Q9H9S5
B	43	ARG	-	expression tag	UNP Q9H9S5
B	44	PRO	-	expression tag	UNP Q9H9S5
C	41	GLY	-	expression tag	UNP Q9H9S5
C	42	GLY	-	expression tag	UNP Q9H9S5
C	43	ARG	-	expression tag	UNP Q9H9S5
C	44	PRO	-	expression tag	UNP Q9H9S5
D	41	GLY	-	expression tag	UNP Q9H9S5
D	42	GLY	-	expression tag	UNP Q9H9S5
D	43	ARG	-	expression tag	UNP Q9H9S5
D	44	PRO	-	expression tag	UNP Q9H9S5

- Molecule 2 is ZINC ION (three-letter code: ZN) (formula: Zn) (labeled as "Ligand of Interest" by author).

Mol	Chain	Residues	Atoms	ZeroOcc	AltConf
2	B	1	Total Zn 1 1	0	0
2	A	1	Total Zn 1 1	0	0
2	D	1	Total Zn 1 1	0	0
2	C	1	Total Zn 1 1	0	0

- Molecule 3 is 2-acetamido-2-deoxy-beta-D-glucopyranose (three-letter code: NAG) (formula: $C_8H_{15}NO_6$).

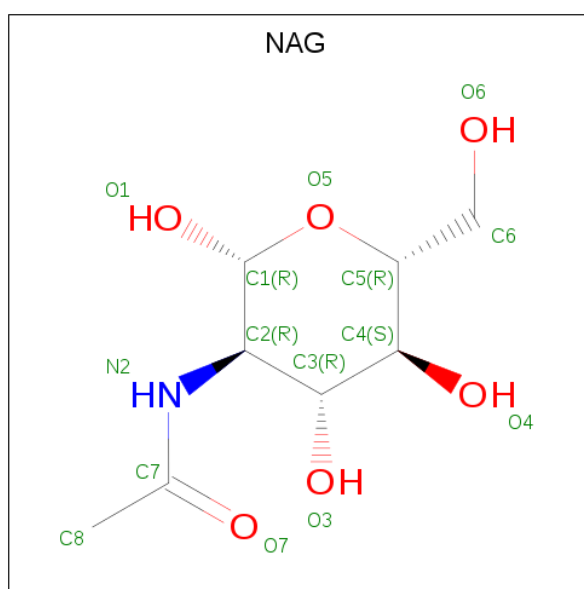

Mol	Chain	Residues	Atoms	ZeroOcc	AltConf
3	A	1	Total C N O 14 8 1 5	0	0
3	A	1	Total C N O 14 8 1 5	0	0
3	B	1	Total C N O 14 8 1 5	0	0
3	B	1	Total C N O 14 8 1 5	0	0
3	C	1	Total C N O 14 8 1 5	0	0
3	C	1	Total C N O 14 8 1 5	0	0
3	D	1	Total C N O 14 8 1 5	0	0

Continued on next page...

Continued from previous page...

Mol	Chain	Residues	Atoms				ZeroOcc	AltConf
3	D	1	Total	C	N	O	0	0
			14	8	1	5		

- Molecule 4 is MAGNESIUM ION (three-letter code: MG) (formula: Mg) (labeled as "Ligand of Interest" by author).

Mol	Chain	Residues	Atoms		ZeroOcc	AltConf
4	B	2	Total	Mg	0	0
			2	2		
4	A	2	Total	Mg	0	0
			2	2		
4	D	2	Total	Mg	0	0
			2	2		
4	C	1	Total	Mg	0	0
			1	1		

- Molecule 5 is water.

Mol	Chain	Residues	Atoms		ZeroOcc	AltConf
5	A	269	Total	O	0	0
			269	269		
5	B	192	Total	O	0	0
			192	192		
5	C	260	Total	O	0	0
			260	260		
5	D	222	Total	O	0	0
			222	222		

3 Residue-property plots [i](#)

These plots are drawn for all protein, RNA, DNA and oligosaccharide chains in the entry. The first graphic for a chain summarises the proportions of the various outlier classes displayed in the second graphic. The second graphic shows the sequence view annotated by issues in geometry and electron density. Residues are color-coded according to the number of geometric quality criteria for which they contain at least one outlier: green = 0, yellow = 1, orange = 2 and red = 3 or more. A red dot above a residue indicates a poor fit to the electron density ($RSRZ > 2$). Stretches of 2 or more consecutive residues without any outlier are shown as a green connector. Residues present in the sample, but not in the model, are shown in grey.

- Molecule 1: Fukutin-related protein

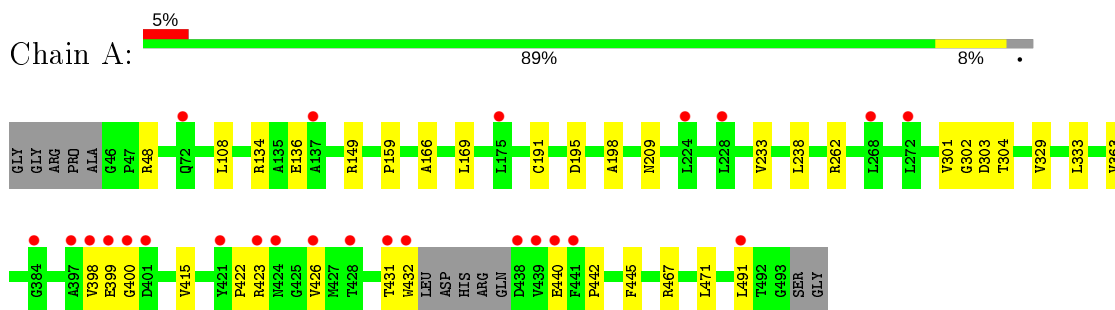

- Molecule 1: Fukutin-related protein

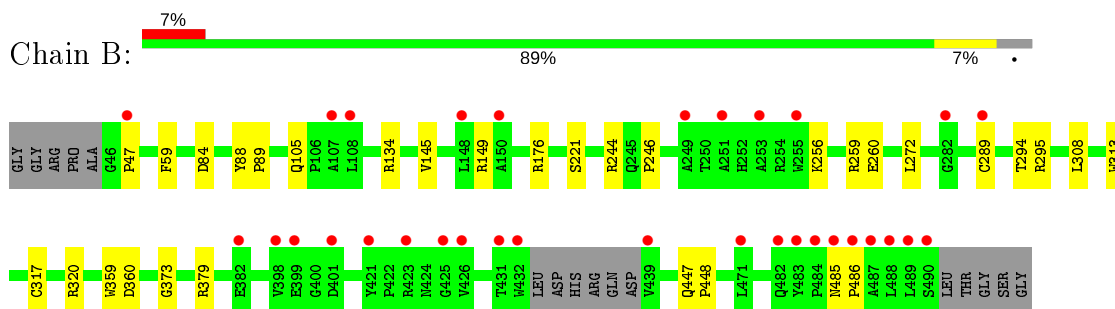

- Molecule 1: Fukutin-related protein

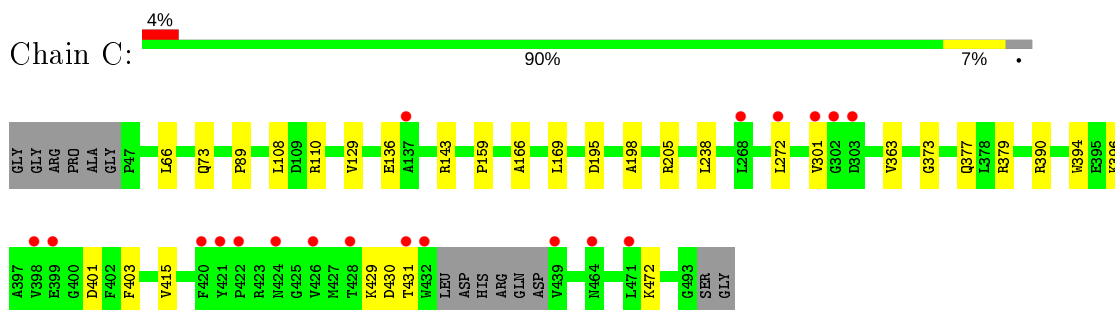

- Molecule 1: Fukutin-related protein

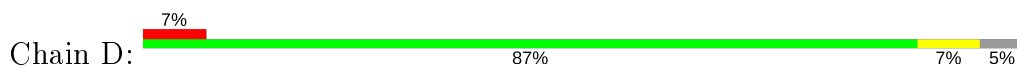

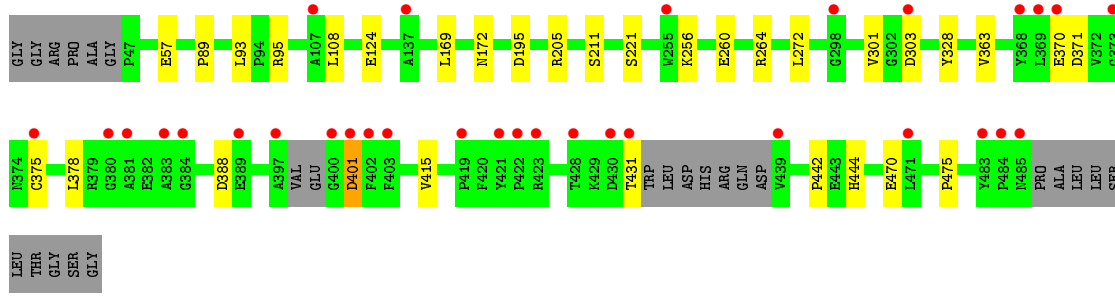

4 Data and refinement statistics

Property	Value	Source
Space group	P 21 21 21	Depositor
Cell constants a, b, c, α , β , γ	76.82Å 119.42Å 258.07Å 90.00° 90.00° 90.00°	Depositor
Resolution (Å)	49.41 – 2.06 49.41 – 2.06	Depositor EDS
% Data completeness (in resolution range)	99.7 (49.41-2.06) 99.7 (49.41-2.06)	Depositor EDS
R_{merge}	(Not available)	Depositor
R_{sym}	(Not available)	Depositor
$\langle I/\sigma(I) \rangle$ ¹	1.15 (at 2.05Å)	Xtrriage
Refinement program	PHENIX (1.13_2998: ???)	Depositor
R, R_{free}	0.196 , 0.227 0.196 , 0.227	Depositor DCC
R_{free} test set	7466 reflections (5.06%)	wwPDB-VP
Wilson B-factor (Å ²)	37.0	Xtrriage
Anisotropy	0.395	Xtrriage
Bulk solvent k_{sol} (e/Å ³), B_{sol} (Å ²)	0.34 , 50.0	EDS
L-test for twinning ²	$\langle L \rangle = 0.49$, $\langle L^2 \rangle = 0.32$	Xtrriage
Estimated twinning fraction	No twinning to report.	Xtrriage
F_o, F_c correlation	0.96	EDS
Total number of atoms	14589	wwPDB-VP
Average B, all atoms (Å ²)	46.0	wwPDB-VP

Xtrriage's analysis on translational NCS is as follows: *The analyses of the Patterson function reveals a significant off-origin peak that is 22.07 % of the origin peak, indicating pseudo-translational symmetry. The chance of finding a peak of this or larger height randomly in a structure without pseudo-translational symmetry is equal to 6.1437e-03. The detected translational NCS is most likely also responsible for the elevated intensity ratio.*

¹Intensities estimated from amplitudes.

²Theoretical values of $\langle |L| \rangle$, $\langle L^2 \rangle$ for acentric reflections are 0.5, 0.333 respectively for untwinned datasets, and 0.375, 0.2 for perfectly twinned datasets.

5 Model quality [i](#)

5.1 Standard geometry [i](#)

Bond lengths and bond angles in the following residue types are not validated in this section: MG, ZN, NAG

The Z score for a bond length (or angle) is the number of standard deviations the observed value is removed from the expected value. A bond length (or angle) with $|Z| > 5$ is considered an outlier worth inspection. RMSZ is the root-mean-square of all Z scores of the bond lengths (or angles).

Mol	Chain	Bond lengths		Bond angles	
		RMSZ	# Z >5	RMSZ	# Z >5
1	A	0.27	0/3510	0.48	0/4809
1	B	0.26	0/3473	0.47	0/4761
1	C	0.26	0/3504	0.46	0/4798
1	D	0.26	0/3412	0.47	0/4674
All	All	0.26	0/13899	0.47	0/19042

Chiral center outliers are detected by calculating the chiral volume of a chiral center and verifying if the center is modelled as a planar moiety or with the opposite hand. A planarity outlier is detected by checking planarity of atoms in a peptide group, atoms in a mainchain group or atoms of a sidechain that are expected to be planar.

Mol	Chain	#Chirality outliers	#Planarity outliers
1	D	0	1

There are no bond length outliers.

There are no bond angle outliers.

There are no chirality outliers.

All (1) planarity outliers are listed below:

Mol	Chain	Res	Type	Group
1	D	401	ASP	Peptide

5.2 Too-close contacts [i](#)

In the following table, the Non-H and H(model) columns list the number of non-hydrogen atoms and hydrogen atoms in the chain respectively. The H(added) column lists the number of hydrogen atoms added and optimized by MolProbity. The Clashes column lists the number of clashes within the asymmetric unit, whereas Symm-Clashes lists symmetry related clashes.

Mol	Chain	Non-H	H(model)	H(added)	Clashes	Symm-Clashes
1	A	3416	0	3347	25	0
1	B	3379	0	3297	18	0
1	C	3410	0	3354	24	0
1	D	3318	0	3230	20	0
2	A	1	0	0	0	0
2	B	1	0	0	0	0
2	C	1	0	0	0	0
2	D	1	0	0	0	0
3	A	28	0	26	0	0
3	B	28	0	26	0	0
3	C	28	0	26	1	0
3	D	28	0	26	3	0
4	A	2	0	0	0	0
4	B	2	0	0	0	0
4	C	1	0	0	0	0
4	D	2	0	0	0	0
5	A	269	0	0	2	0
5	B	192	0	0	1	0
5	C	260	0	0	2	0
5	D	222	0	0	1	0
All	All	14589	0	13332	80	0

The all-atom clashscore is defined as the number of clashes found per 1000 atoms (including hydrogen atoms). The all-atom clashscore for this structure is 3.

The worst 5 of 80 close contacts within the same asymmetric unit are listed below, sorted by their clash magnitude.

Atom-1	Atom-2	Interatomic distance (Å)	Clash overlap (Å)
1:A:467:ARG:O	1:A:471:LEU:CD2	2.28	0.81
1:D:470:GLU:HG2	1:D:475:PRO:HA	1.64	0.80
1:A:467:ARG:O	1:A:471:LEU:HD22	1.83	0.79
1:C:373:GLY:O	1:C:379:ARG:NH1	2.15	0.79
1:D:401:ASP:OD2	1:D:431:THR:HB	1.92	0.70

There are no symmetry-related clashes.

5.3 Torsion angles [i](#)

5.3.1 Protein backbone [i](#)

In the following table, the Percentiles column shows the percent Ramachandran outliers of the chain as a percentile score with respect to all X-ray entries followed by that with respect to entries of similar resolution.

The Analysed column shows the number of residues for which the backbone conformation was analysed, and the total number of residues.

Mol	Chain	Analysed	Favoured	Allowed	Outliers	Percentiles	
1	A	439/455 (96%)	427 (97%)	11 (2%)	1 (0%)	47	39
1	B	435/455 (96%)	422 (97%)	13 (3%)	0	100	100
1	C	437/455 (96%)	430 (98%)	7 (2%)	0	100	100
1	D	425/455 (93%)	419 (99%)	5 (1%)	1 (0%)	47	39
All	All	1736/1820 (95%)	1698 (98%)	36 (2%)	2 (0%)	51	45

All (2) Ramachandran outliers are listed below:

Mol	Chain	Res	Type
1	A	303	ASP
1	D	303	ASP

5.3.2 Protein sidechains [i](#)

In the following table, the Percentiles column shows the percent sidechain outliers of the chain as a percentile score with respect to all X-ray entries followed by that with respect to entries of similar resolution.

The Analysed column shows the number of residues for which the sidechain conformation was analysed, and the total number of residues.

Mol	Chain	Analysed	Rotameric	Outliers	Percentiles	
1	A	342/357 (96%)	341 (100%)	1 (0%)	92	93
1	B	338/357 (95%)	335 (99%)	3 (1%)	78	78
1	C	343/357 (96%)	341 (99%)	2 (1%)	86	86
1	D	332/357 (93%)	331 (100%)	1 (0%)	92	93
All	All	1355/1428 (95%)	1348 (100%)	7 (0%)	88	89

5 of 7 residues with a non-rotameric sidechain are listed below:

Mol	Chain	Res	Type
1	B	360	ASP
1	D	221	SER
1	C	401	ASP
1	B	134	ARG
1	C	472	LYS

Some sidechains can be flipped to improve hydrogen bonding and reduce clashes. There are no such sidechains identified.

5.3.3 RNA [i](#)

There are no RNA molecules in this entry.

5.4 Non-standard residues in protein, DNA, RNA chains [i](#)

There are no non-standard protein/DNA/RNA residues in this entry.

5.5 Carbohydrates [i](#)

There are no monosaccharides in this entry.

5.6 Ligand geometry [i](#)

Of 19 ligands modelled in this entry, 11 are monoatomic - leaving 8 for Mogul analysis.

In the following table, the Counts columns list the number of bonds (or angles) for which Mogul statistics could be retrieved, the number of bonds (or angles) that are observed in the model and the number of bonds (or angles) that are defined in the Chemical Component Dictionary. The Link column lists molecule types, if any, to which the group is linked. The Z score for a bond length (or angle) is the number of standard deviations the observed value is removed from the expected value. A bond length (or angle) with $|Z| > 2$ is considered an outlier worth inspection. RMSZ is the root-mean-square of all Z scores of the bond lengths (or angles).

Mol	Type	Chain	Res	Link	Bond lengths			Bond angles		
					Counts	RMSZ	$\# Z > 2$	Counts	RMSZ	$\# Z > 2$
3	NAG	A	502	1	14,14,15	0.36	0	17,19,21	0.39	0
3	NAG	C	502	1	14,14,15	0.38	0	17,19,21	0.71	0
3	NAG	D	503	1	14,14,15	0.24	0	17,19,21	0.53	0
3	NAG	C	503	1	14,14,15	0.17	0	17,19,21	0.56	0
3	NAG	B	503	1	14,14,15	0.40	0	17,19,21	0.59	0
3	NAG	A	503	1	14,14,15	0.27	0	17,19,21	0.69	1 (5%)

Mol	Type	Chain	Res	Link	Bond lengths			Bond angles		
					Counts	RMSZ	# Z > 2	Counts	RMSZ	# Z > 2
3	NAG	B	502	1	14,14,15	0.41	0	17,19,21	0.40	0
3	NAG	D	502	1	14,14,15	0.79	1 (7%)	17,19,21	0.79	1 (5%)

In the following table, the Chirals column lists the number of chiral outliers, the number of chiral centers analysed, the number of these observed in the model and the number defined in the Chemical Component Dictionary. Similar counts are reported in the Torsion and Rings columns. '-' means no outliers of that kind were identified.

Mol	Type	Chain	Res	Link	Chirals	Torsions	Rings
3	NAG	A	502	1	-	2/6/23/26	0/1/1/1
3	NAG	C	502	1	-	0/6/23/26	0/1/1/1
3	NAG	D	503	1	-	2/6/23/26	0/1/1/1
3	NAG	C	503	1	-	2/6/23/26	0/1/1/1
3	NAG	B	503	1	-	1/6/23/26	0/1/1/1
3	NAG	A	503	1	-	2/6/23/26	0/1/1/1
3	NAG	B	502	1	-	2/6/23/26	0/1/1/1
3	NAG	D	502	1	-	1/6/23/26	0/1/1/1

All (1) bond length outliers are listed below:

Mol	Chain	Res	Type	Atoms	Z	Observed(Å)	Ideal(Å)
3	D	502	NAG	C1-C2	2.74	1.56	1.52

All (2) bond angle outliers are listed below:

Mol	Chain	Res	Type	Atoms	Z	Observed(°)	Ideal(°)
3	D	502	NAG	C1-O5-C5	2.69	115.84	112.19
3	A	503	NAG	C1-O5-C5	2.17	115.14	112.19

There are no chirality outliers.

5 of 12 torsion outliers are listed below:

Mol	Chain	Res	Type	Atoms
3	C	503	NAG	C4-C5-C6-O6
3	D	503	NAG	C8-C7-N2-C2
3	D	503	NAG	O7-C7-N2-C2
3	C	503	NAG	O5-C5-C6-O6
3	B	502	NAG	C4-C5-C6-O6

There are no ring outliers.

3 monomers are involved in 4 short contacts:

Mol	Chain	Res	Type	Clashes	Symm-Clashes
3	D	503	NAG	1	0
3	C	503	NAG	1	0
3	D	502	NAG	2	0

5.7 Other polymers [i](#)

There are no such residues in this entry.

5.8 Polymer linkage issues [i](#)

There are no chain breaks in this entry.

6 Fit of model and data [i](#)

6.1 Protein, DNA and RNA chains [i](#)

In the following table, the column labelled ‘#RSRZ> 2’ contains the number (and percentage) of RSRZ outliers, followed by percent RSRZ outliers for the chain as percentile scores relative to all X-ray entries and entries of similar resolution. The OWAB column contains the minimum, median, 95th percentile and maximum values of the occupancy-weighted average B-factor per residue. The column labelled ‘Q< 0.9’ lists the number of (and percentage) of residues with an average occupancy less than 0.9.

Mol	Chain	Analysed	<RSRZ>	#RSRZ>2	OWAB(Å ²)	Q<0.9
1	A	443/455 (97%)	0.54	25 (5%) 24 25	24, 40, 79, 116	0
1	B	439/455 (96%)	0.55	32 (7%) 15 15	25, 43, 84, 117	0
1	C	441/455 (96%)	0.48	19 (4%) 35 36	24, 40, 75, 109	0
1	D	430/455 (94%)	0.51	32 (7%) 14 15	25, 43, 84, 120	0
All	All	1753/1820 (96%)	0.52	108 (6%) 20 21	24, 41, 83, 120	0

The worst 5 of 108 RSRZ outliers are listed below:

Mol	Chain	Res	Type	RSRZ
1	B	398	VAL	12.0
1	A	398	VAL	9.2
1	B	485	ASN	8.7
1	B	486	PRO	7.5
1	C	432	TRP	7.0

6.2 Non-standard residues in protein, DNA, RNA chains [i](#)

There are no non-standard protein/DNA/RNA residues in this entry.

6.3 Carbohydrates [i](#)

There are no monosaccharides in this entry.

6.4 Ligands [i](#)

In the following table, the Atoms column lists the number of modelled atoms in the group and the number defined in the chemical component dictionary. The B-factors column lists the minimum, median, 95th percentile and maximum values of B factors of atoms in the group. The column labelled ‘Q< 0.9’ lists the number of atoms with occupancy less than 0.9.

Mol	Type	Chain	Res	Atoms	RSCC	RSR	B-factors(\AA^2)	Q<0.9
4	MG	A	505	1/1	0.48	0.85	124,124,124,124	0
4	MG	D	504	1/1	0.56	0.17	87,87,87,87	0
3	NAG	B	503	14/15	0.60	0.39	73,81,88,89	0
3	NAG	D	502	14/15	0.64	0.31	77,83,87,87	0
3	NAG	D	503	14/15	0.66	0.33	61,66,69,71	0
4	MG	C	504	1/1	0.67	0.09	60,60,60,60	0
4	MG	A	504	1/1	0.79	0.06	70,70,70,70	0
3	NAG	B	502	14/15	0.80	0.22	62,70,76,76	0
3	NAG	C	503	14/15	0.84	0.15	44,47,57,58	0
3	NAG	A	503	14/15	0.87	0.17	46,49,60,62	0
4	MG	B	504	1/1	0.88	0.18	56,56,56,56	0
3	NAG	A	502	14/15	0.89	0.16	44,54,62,63	0
3	NAG	C	502	14/15	0.91	0.14	49,58,78,82	0
4	MG	B	505	1/1	0.91	0.19	61,61,61,61	0
4	MG	D	505	1/1	0.91	0.32	108,108,108,108	0
2	ZN	B	501	1/1	0.98	0.10	38,38,38,38	0
2	ZN	A	501	1/1	0.99	0.15	29,29,29,29	0
2	ZN	D	501	1/1	0.99	0.12	33,33,33,33	0
2	ZN	C	501	1/1	1.00	0.16	30,30,30,30	0

The following is a graphical depiction of the model fit to experimental electron density of all instances of the Ligand of Interest. In addition, ligands with molecular weight > 250 and outliers as shown on the geometry validation Tables will also be included. Each fit is shown from different orientation to approximate a three-dimensional view.

Electron density around MG A 505:

$2mF_o-DF_c$ (at 0.7 rmsd) in gray
 mF_o-DF_c (at 3 rmsd) in purple (negative)
and green (positive)

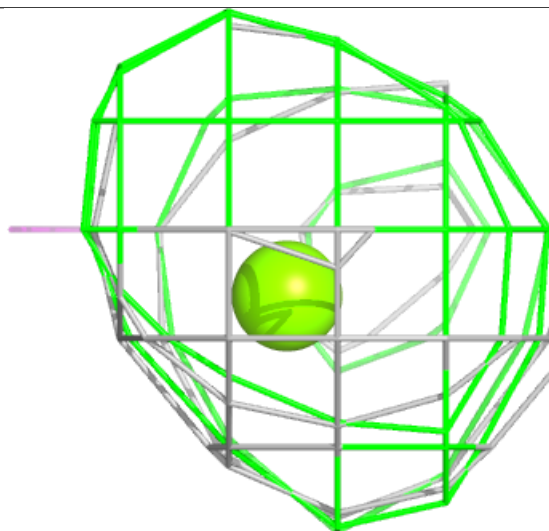
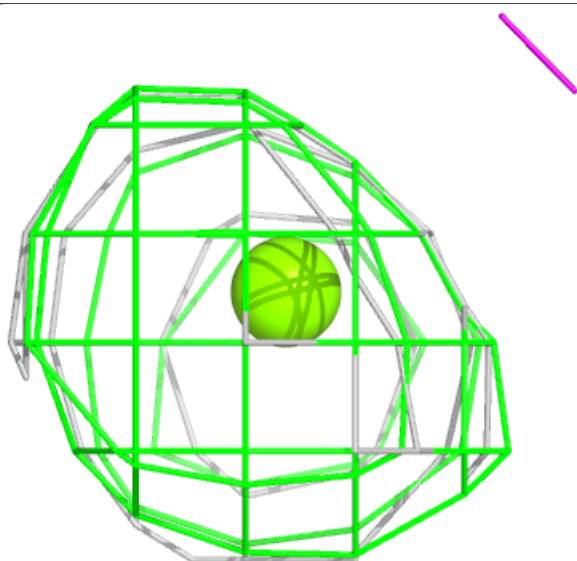
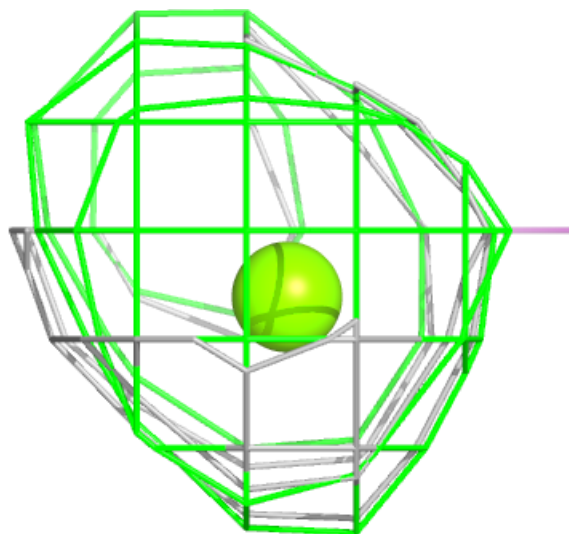

Electron density around MG D 504:

$2mF_o-DF_c$ (at 0.7 rmsd) in gray
 mF_o-DF_c (at 3 rmsd) in purple (negative)
and green (positive)

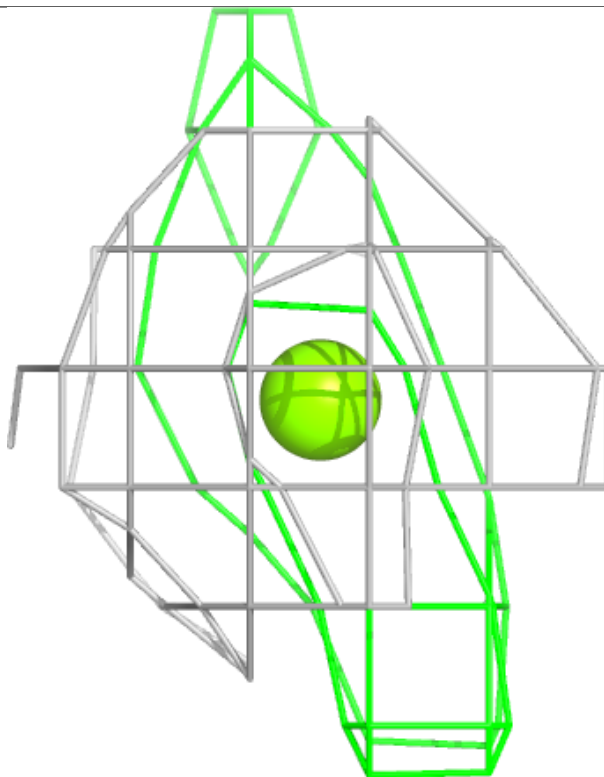
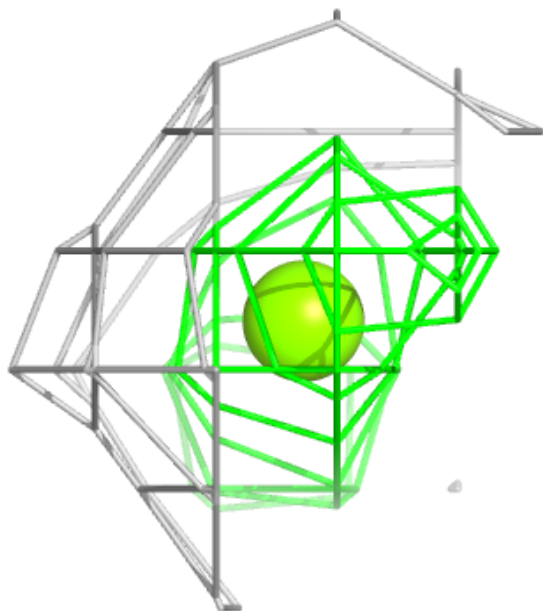
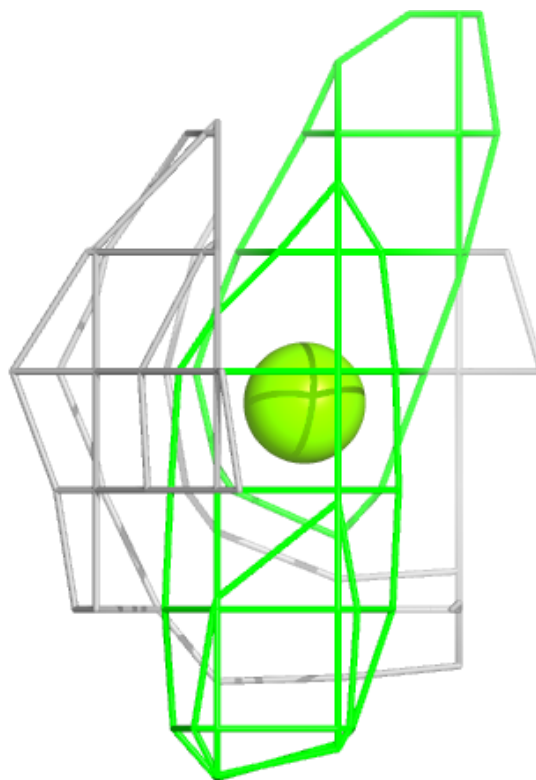

Electron density around MG C 504:

$2mF_o-DF_c$ (at 0.7 rmsd) in gray
 mF_o-DF_c (at 3 rmsd) in purple (negative)
and green (positive)

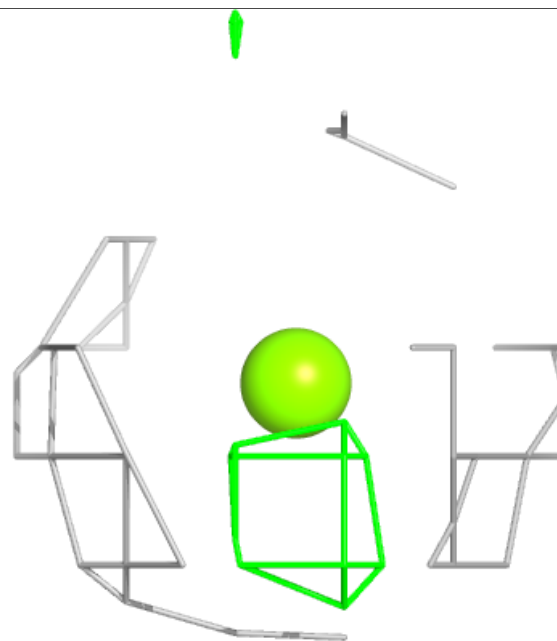
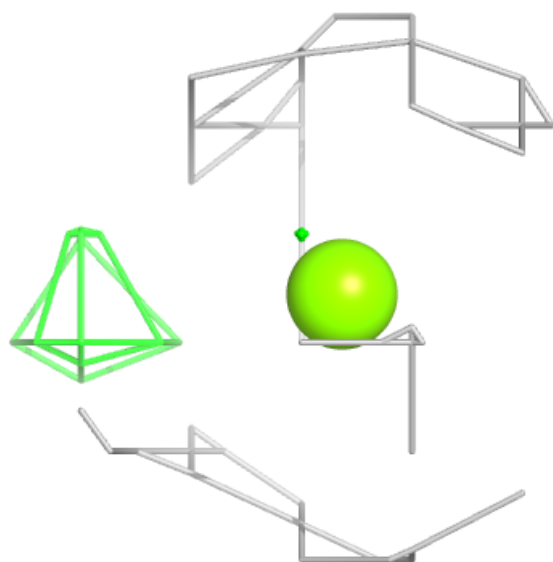
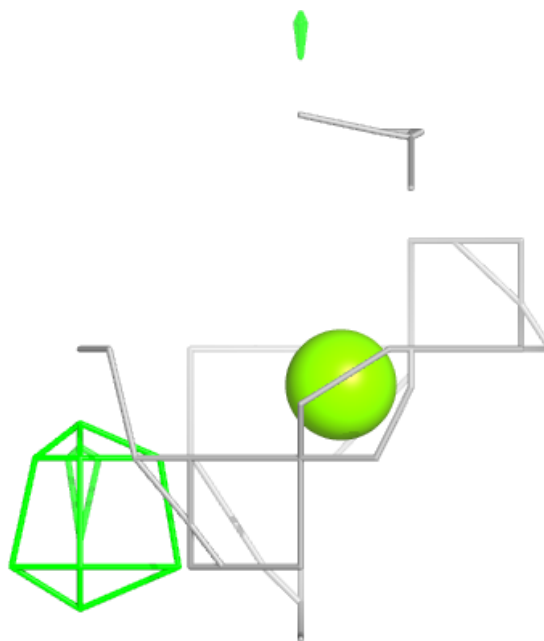

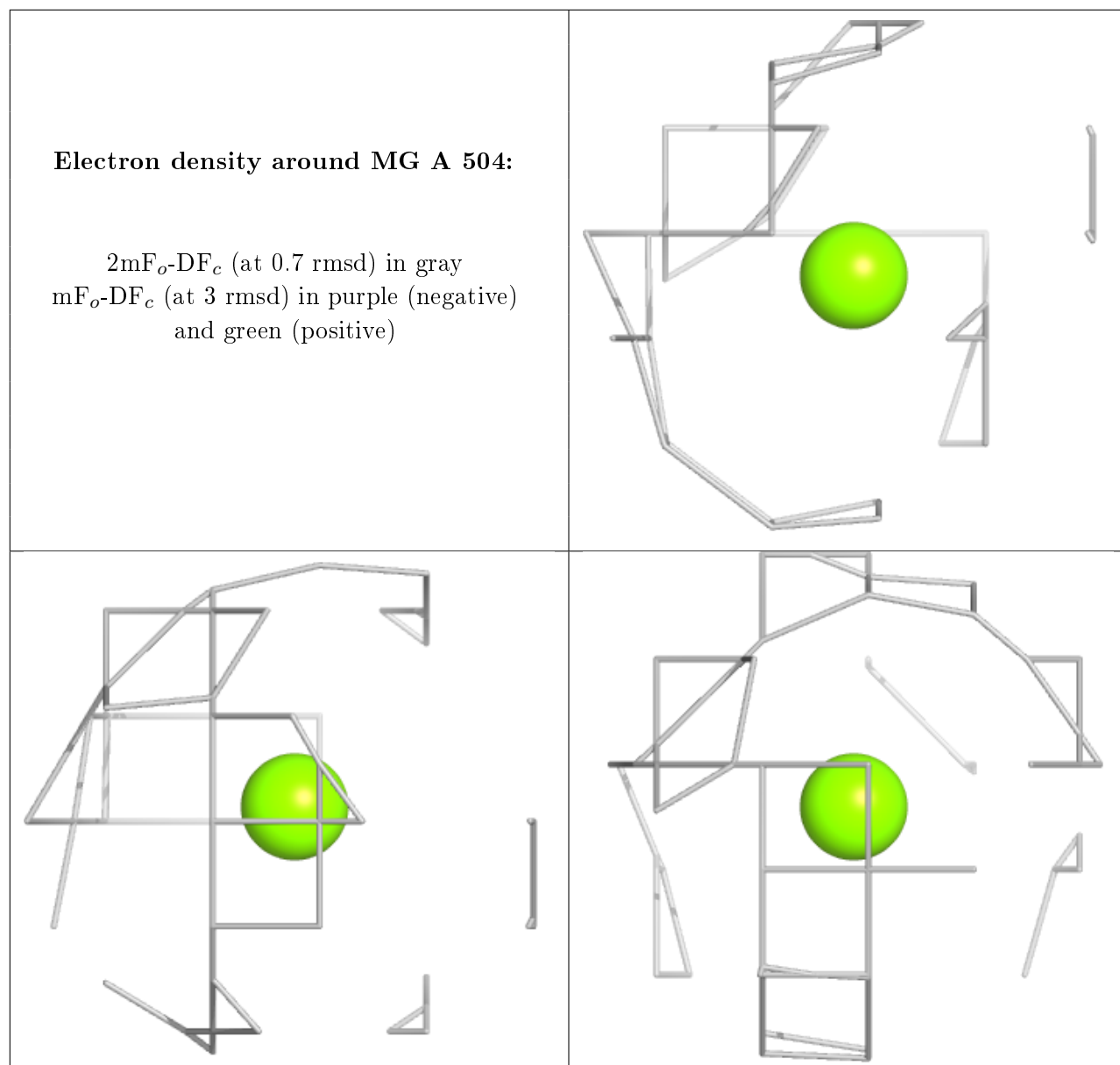

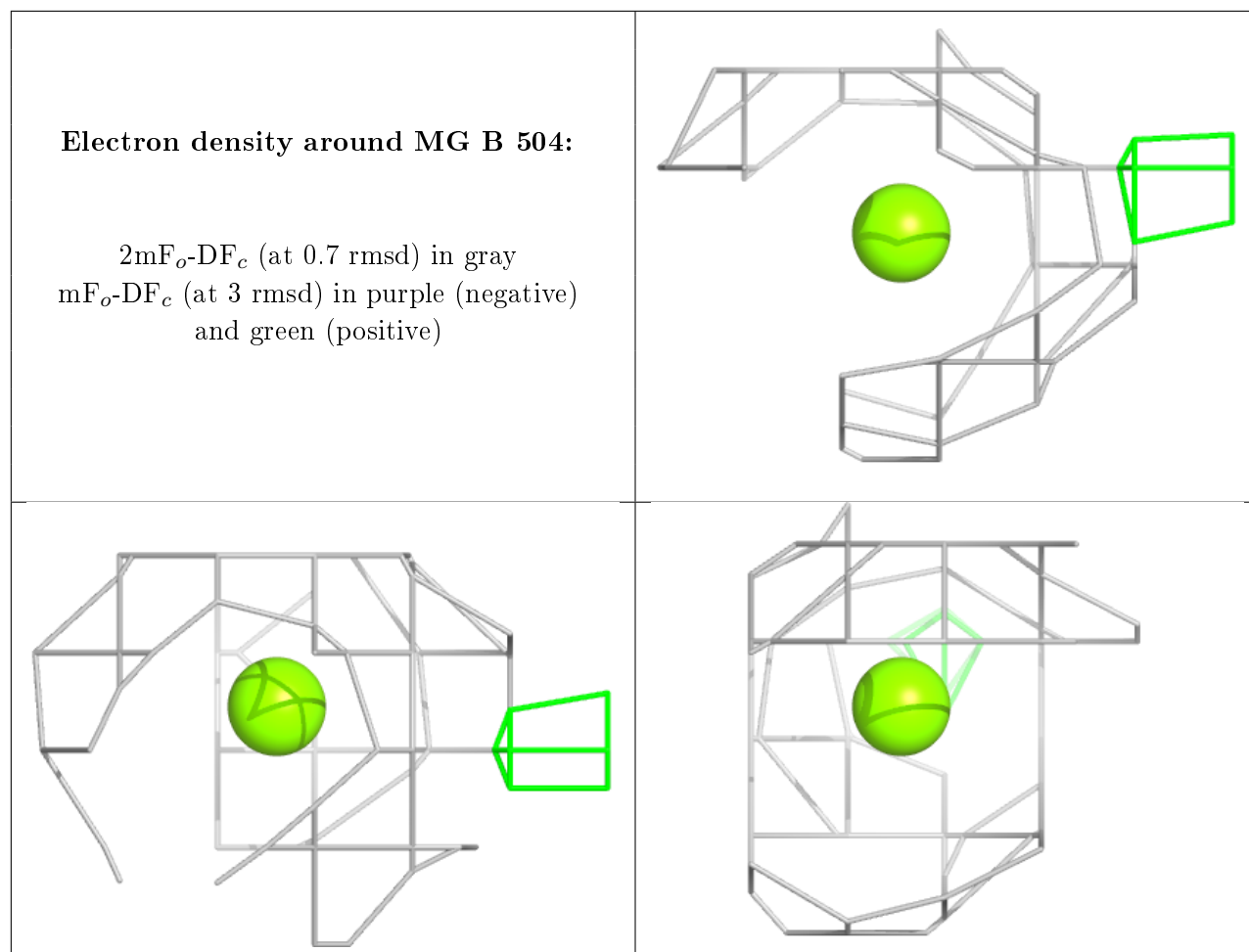

Electron density around MG B 505:

$2mF_o-DF_c$ (at 0.7 rmsd) in gray
 mF_o-DF_c (at 3 rmsd) in purple (negative)
and green (positive)

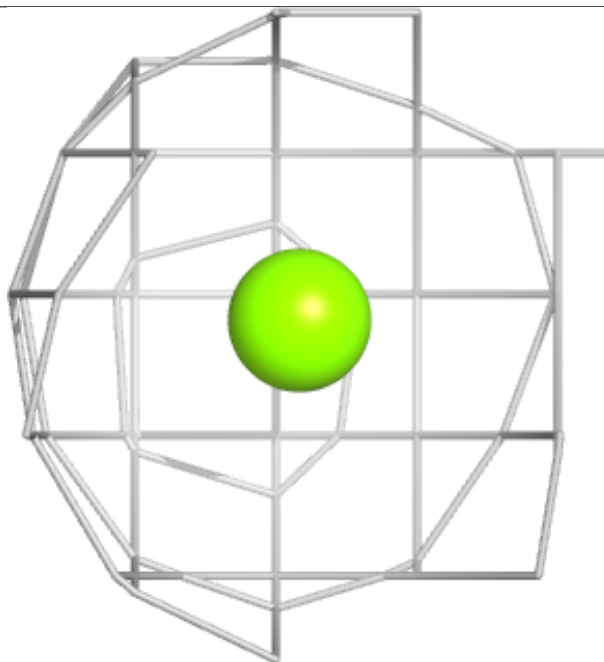
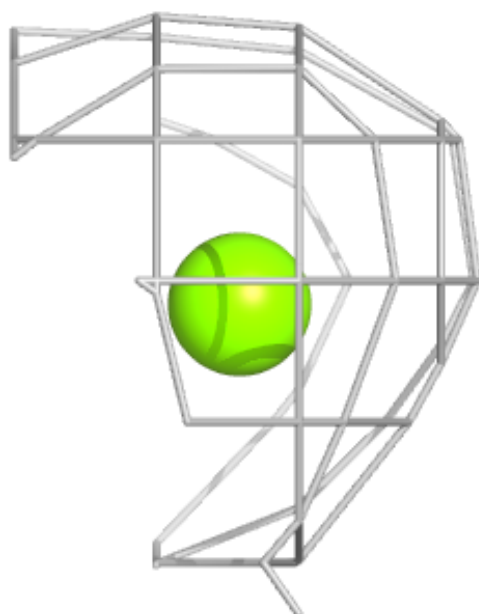

Electron density around MG D 505:

$2mF_o-DF_c$ (at 0.7 rmsd) in gray
 mF_o-DF_c (at 3 rmsd) in purple (negative)
and green (positive)

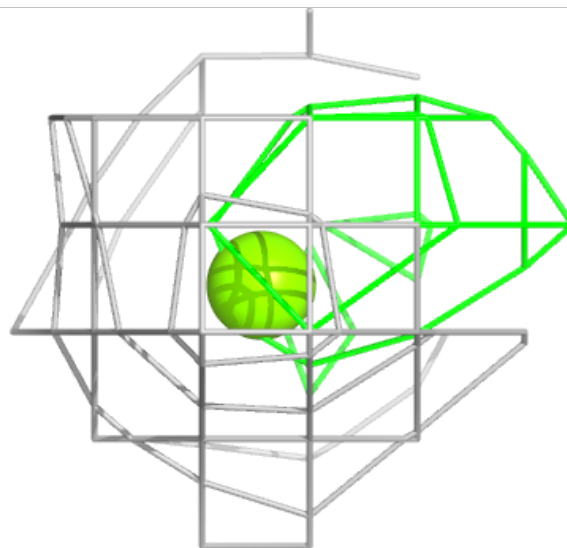
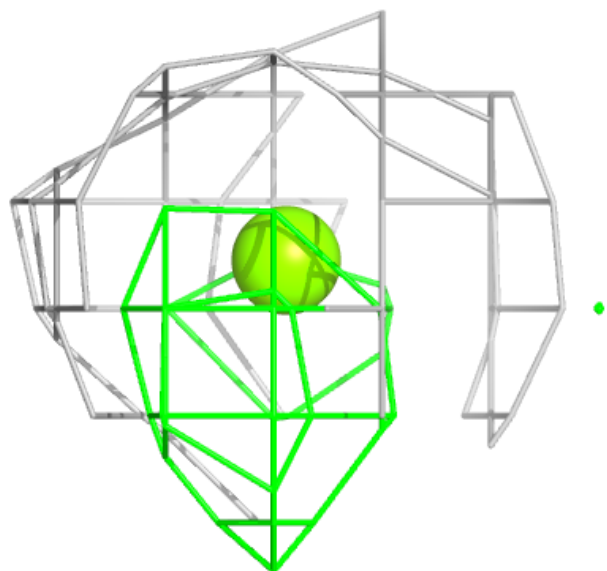
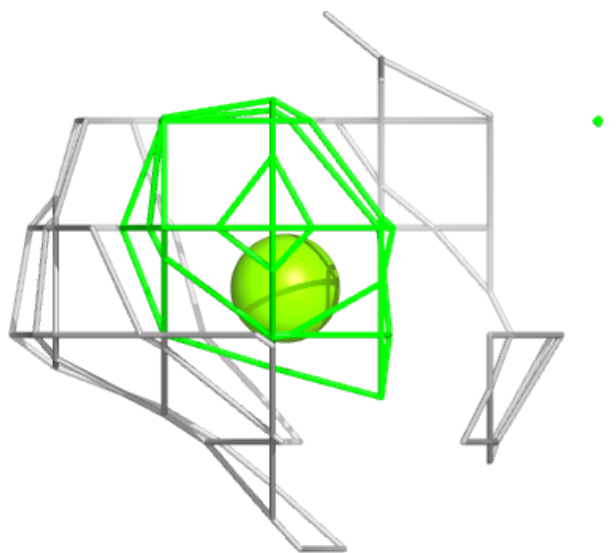

Electron density around ZN B 501:

$2mF_o-DF_c$ (at 0.7 rmsd) in gray
 mF_o-DF_c (at 3 rmsd) in purple (negative)
and green (positive)

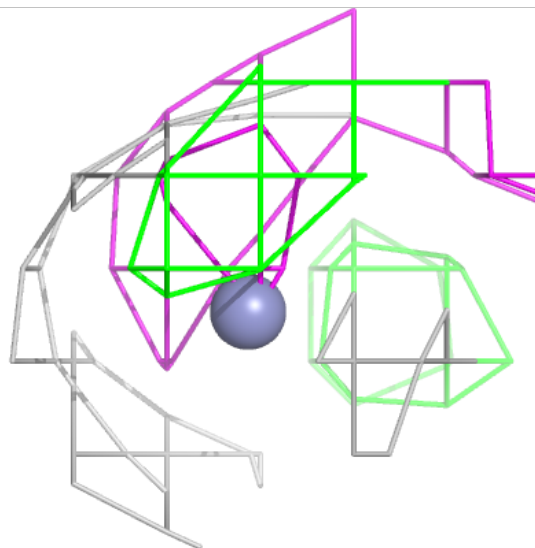
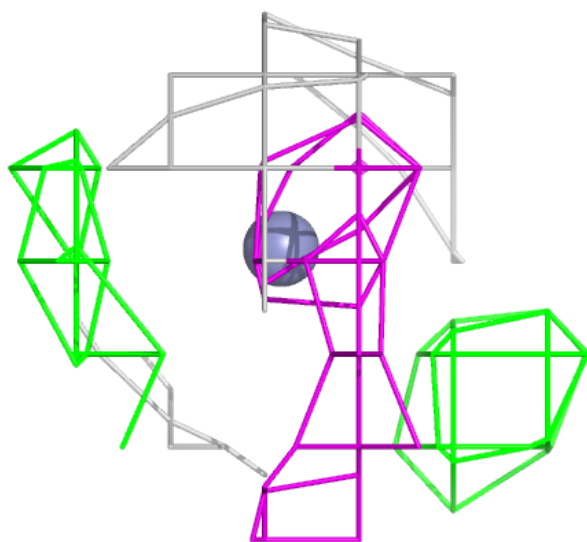
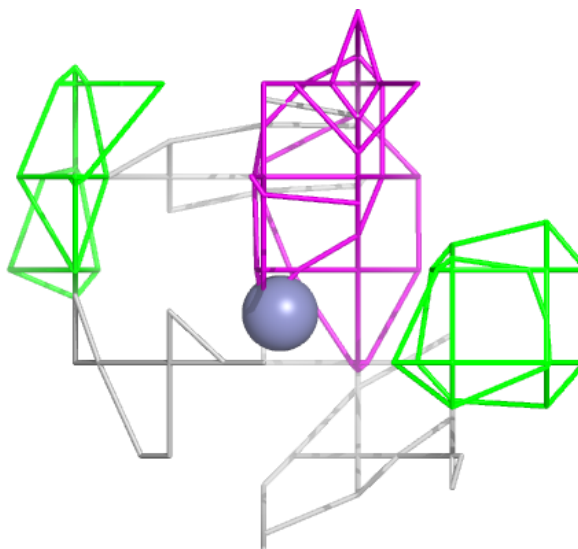

Electron density around ZN A 501:

$2mF_o-DF_c$ (at 0.7 rmsd) in gray
 mF_o-DF_c (at 3 rmsd) in purple (negative)
and green (positive)

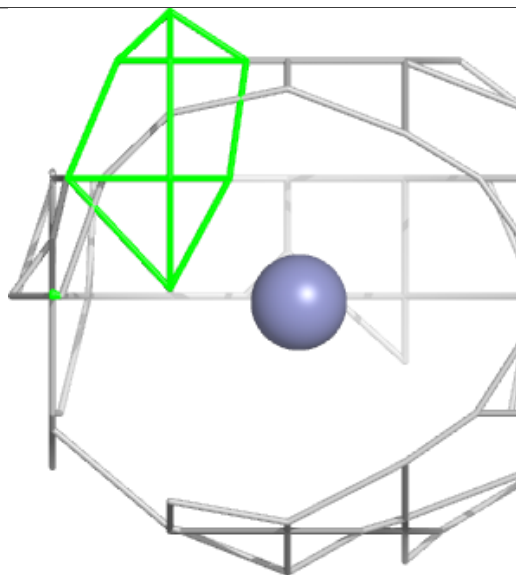
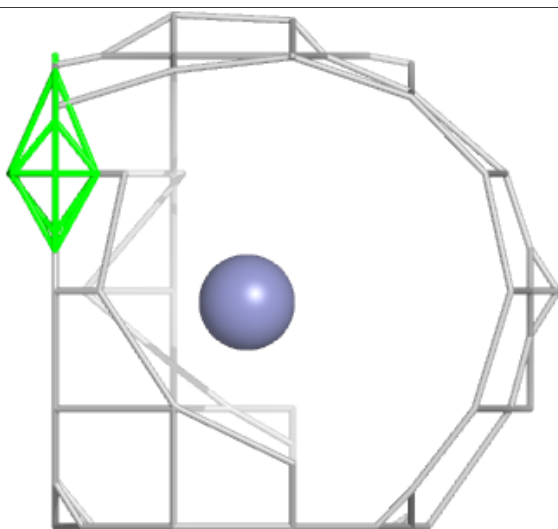
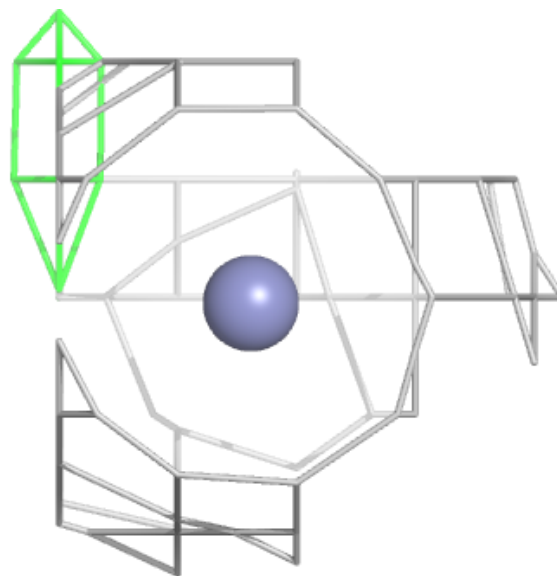

Electron density around ZN D 501:

$2mF_o-DF_c$ (at 0.7 rmsd) in gray
 mF_o-DF_c (at 3 rmsd) in purple (negative)
and green (positive)

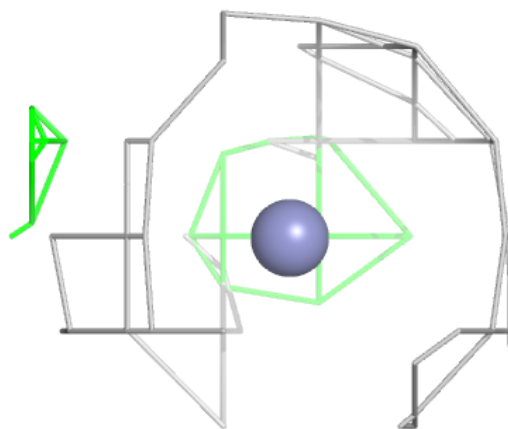
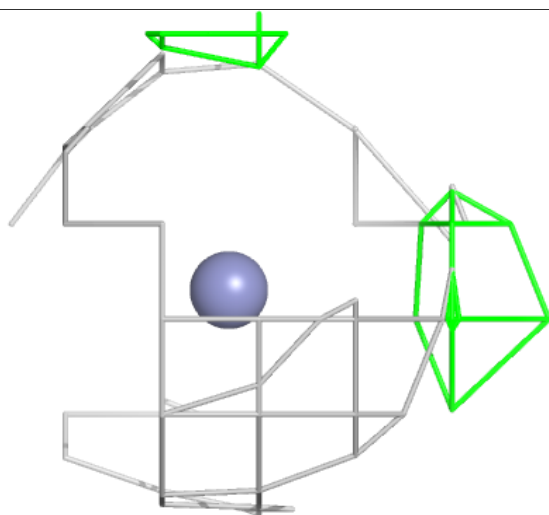
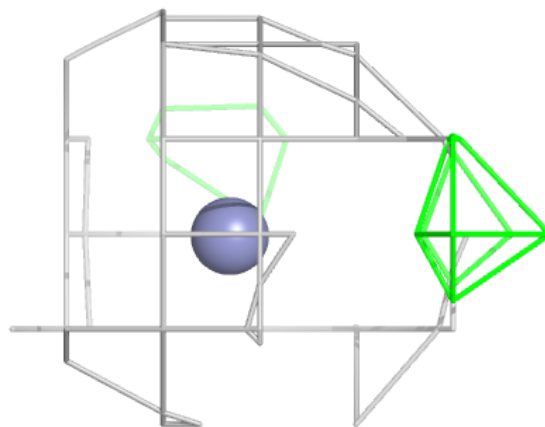

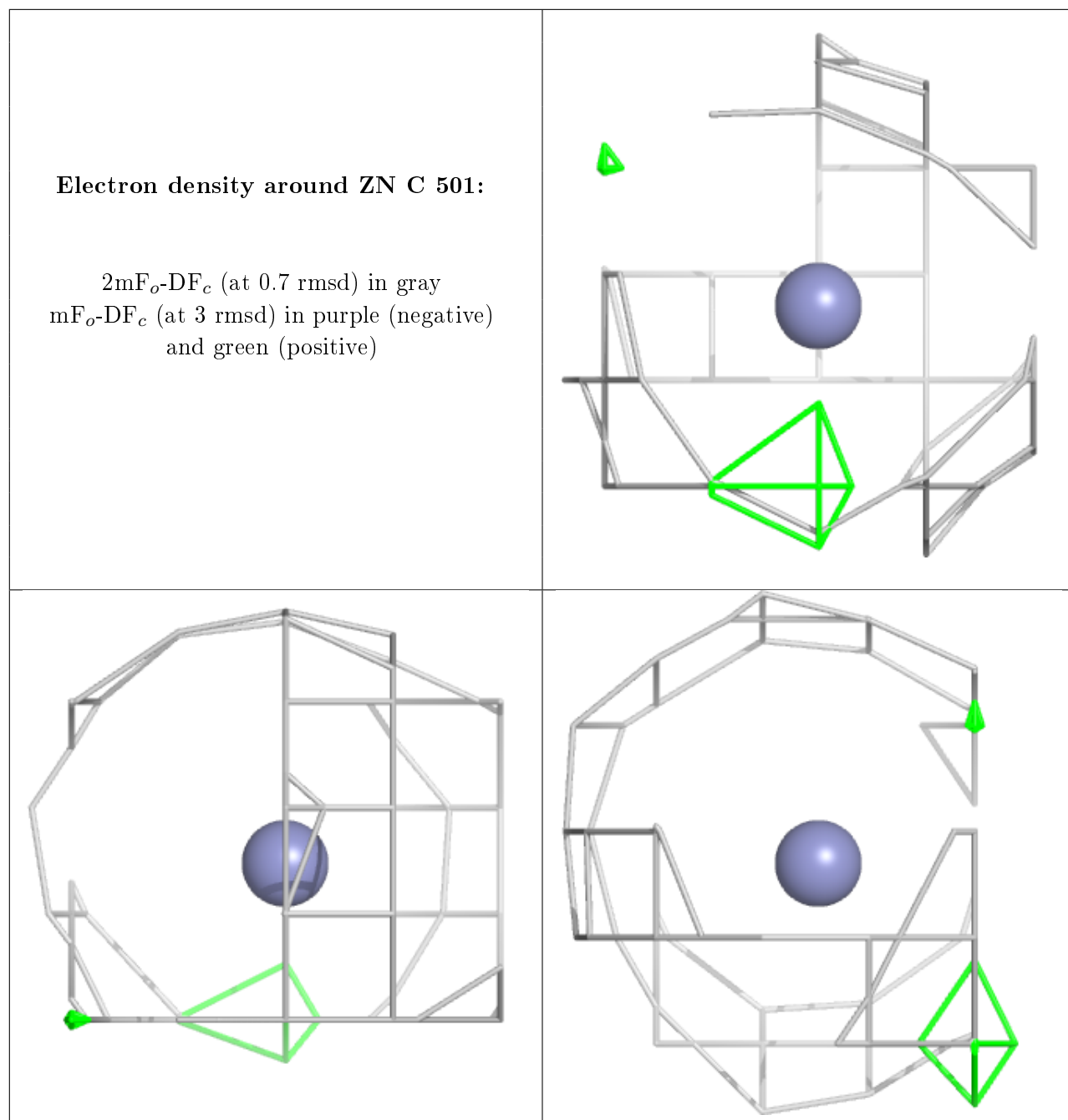

6.5 Other polymers [\(i\)](#)

There are no such residues in this entry.