



wwPDB X-ray Structure Validation Summary Report ⓘ

Oct 8, 2023 – 10:41 AM EDT

PDB ID : 6ECH
Title : Pyruvate Kinase Isoform L-type with phosphorylated Ser12 (pS12) in complex with FBP
Authors : Padyana, A.; Tong, S.
Deposited on : 2018-08-07
Resolution : 2.19 Å(reported)

This is a wwPDB X-ray Structure Validation Summary Report for a publicly released PDB entry.

We welcome your comments at validation@mail.wwpdb.org

A user guide is available at

<https://www.wwpdb.org/validation/2017/XrayValidationReportHelp>

with specific help available everywhere you see the ⓘ symbol.

The types of validation reports are described at

<http://www.wwpdb.org/validation/2017/FAQs#types>.

The following versions of software and data (see [references ⓘ](#)) were used in the production of this report:

MolProbity : 4.02b-467
Mogul : 1.8.5 (274361), CSD as541be (2020)
Xtrriage (Phenix) : 1.13
EDS : 2.35.1
buster-report : 1.1.7 (2018)
Percentile statistics : 20191225.v01 (using entries in the PDB archive December 25th 2019)
Refmac : 5.8.0158
CCP4 : 7.0.044 (Gargrove)
Ideal geometry (proteins) : Engh & Huber (2001)
Ideal geometry (DNA, RNA) : Parkinson et al. (1996)
Validation Pipeline (wwPDB-VP) : 2.35.1

1 Overall quality at a glance

The following experimental techniques were used to determine the structure:

X-RAY DIFFRACTION

The reported resolution of this entry is 2.19 Å.

Percentile scores (ranging between 0-100) for global validation metrics of the entry are shown in the following graphic. The table shows the number of entries on which the scores are based.

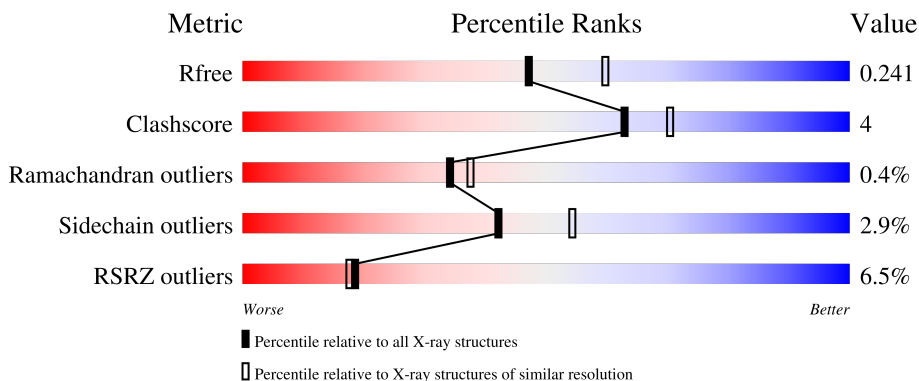

Metric	Whole archive (#Entries)	Similar resolution (#Entries, resolution range(Å))
R_{free}	130704	4898 (2.20-2.20)
Clashscore	141614	5594 (2.20-2.20)
Ramachandran outliers	138981	5503 (2.20-2.20)
Sidechain outliers	138945	5504 (2.20-2.20)
RSRZ outliers	127900	4800 (2.20-2.20)

The table below summarises the geometric issues observed across the polymeric chains and their fit to the electron density. The red, orange, yellow and green segments of the lower bar indicate the fraction of residues that contain outliers for ≥ 3 , 2, 1 and 0 types of geometric quality criteria respectively. A grey segment represents the fraction of residues that are not modelled. The numeric value for each fraction is indicated below the corresponding segment, with a dot representing fractions $\leq 5\%$. The upper red bar (where present) indicates the fraction of residues that have poor fit to the electron density. The numeric value is given above the bar.

Mol	Chain	Length	Quality of chain
1	A	550	 5% 85% 11% •
1	B	550	 4% 86% 8% • 5%
1	C	550	 8% 86% 9% • •
1	D	550	 8% 86% 9% • •

The following table lists non-polymeric compounds, carbohydrate monomers and non-standard

residues in protein, DNA, RNA chains that are outliers for geometric or electron-density-fit criteria:

Mol	Type	Chain	Res	Chirality	Geometry	Clashes	Electron density
3	MG	A	603	-	-	-	X
6	EDO	C	611	-	-	X	-

2 Entry composition

There are 11 unique types of molecules in this entry. The entry contains 17686 atoms, of which 0 are hydrogens and 0 are deuteriums.

In the tables below, the ZeroOcc column contains the number of atoms modelled with zero occupancy, the AltConf column contains the number of residues with at least one atom in alternate conformation and the Trace column contains the number of residues modelled with at most 2 atoms.

- Molecule 1 is a protein called Pyruvate kinase PKLR.

Mol	Chain	Residues	Atoms					ZeroOcc	AltConf	Trace
			Total	C	N	O	S			
1	A	528	4038	2537	722	761	18	0	2	0
1	B	525	4001	2516	715	752	18	0	1	0
1	C	528	4054	2546	734	756	18	0	2	0
1	D	527	4012	2522	717	755	18	0	0	0

There are 28 discrepancies between the modelled and reference sequences:

Chain	Residue	Modelled	Actual	Comment	Reference
A	0	HIS	-	expression tag	UNP P12928
A	544	HIS	-	expression tag	UNP P12928
A	545	HIS	-	expression tag	UNP P12928
A	546	HIS	-	expression tag	UNP P12928
A	547	HIS	-	expression tag	UNP P12928
A	548	HIS	-	expression tag	UNP P12928
A	549	HIS	-	expression tag	UNP P12928
B	0	HIS	-	expression tag	UNP P12928
B	544	HIS	-	expression tag	UNP P12928
B	545	HIS	-	expression tag	UNP P12928
B	546	HIS	-	expression tag	UNP P12928
B	547	HIS	-	expression tag	UNP P12928
B	548	HIS	-	expression tag	UNP P12928
B	549	HIS	-	expression tag	UNP P12928
C	0	HIS	-	expression tag	UNP P12928
C	544	HIS	-	expression tag	UNP P12928
C	545	HIS	-	expression tag	UNP P12928
C	546	HIS	-	expression tag	UNP P12928
C	547	HIS	-	expression tag	UNP P12928
C	548	HIS	-	expression tag	UNP P12928
C	549	HIS	-	expression tag	UNP P12928

Continued on next page...

Continued from previous page...

Chain	Residue	Modelled	Actual	Comment	Reference
D	0	HIS	-	expression tag	UNP P12928
D	544	HIS	-	expression tag	UNP P12928
D	545	HIS	-	expression tag	UNP P12928
D	546	HIS	-	expression tag	UNP P12928
D	547	HIS	-	expression tag	UNP P12928
D	548	HIS	-	expression tag	UNP P12928
D	549	HIS	-	expression tag	UNP P12928

- Molecule 2 is 1,6-di-O-phosphono-beta-D-fructofuranose (three-letter code: FBP) (formula: $C_6H_{14}O_{12}P_2$).

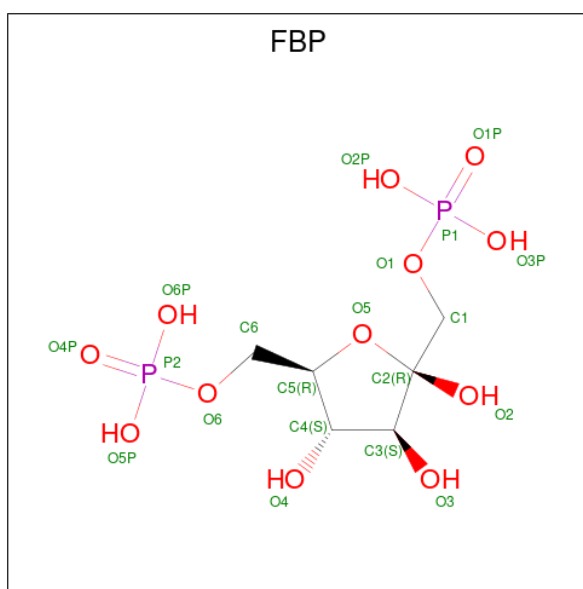

Mol	Chain	Residues	Atoms			ZeroOcc	AltConf						
2	A	1	Total	C	O	P	0	0					
			20	6	12	2							
			2	B	1	Total			C	O	P	0	0
						20			6	12	2		
2	C	1				Total	C	O	P	0	0		
						20	6	12	2				
			2	D	1	Total	C	O	P			0	0
						20	6	12	2				

- Molecule 3 is MAGNESIUM ION (three-letter code: MG) (formula: Mg).

Mol	Chain	Residues	Atoms		ZeroOcc	AltConf
3	A	4	Total	Mg	0	0
			4	4		

Continued on next page...

Continued from previous page...

Mol	Chain	Residues	Atoms	ZeroOcc	AltConf
3	B	4	Total Mg 4 4	0	0
3	C	2	Total Mg 2 2	0	0
3	D	3	Total Mg 3 3	0	0

- Molecule 4 is ADENOSINE-5'-TRIPHOSPHATE (three-letter code: ATP) (formula: $C_{10}H_{16}N_5O_{13}P_3$).

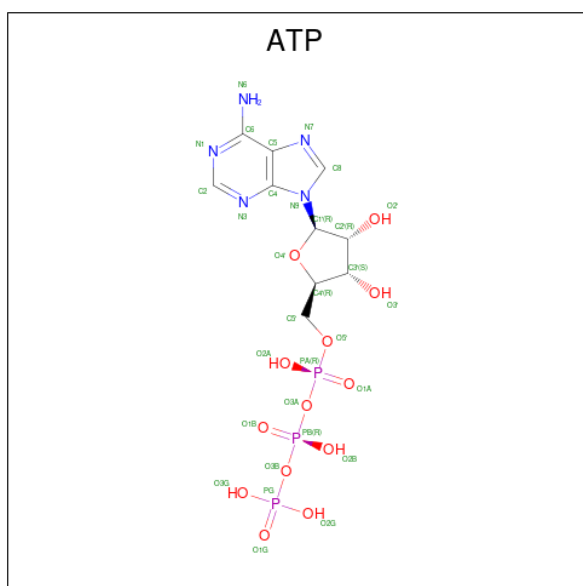

Mol	Chain	Residues	Atoms	ZeroOcc	AltConf
4	A	1	Total C N O P 31 10 5 13 3	0	0
4	B	1	Total C N O P 31 10 5 13 3	0	0
4	D	1	Total C N O P 31 10 5 13 3	0	0

- Molecule 5 is OXALATE ION (three-letter code: OXL) (formula: C_2O_4).

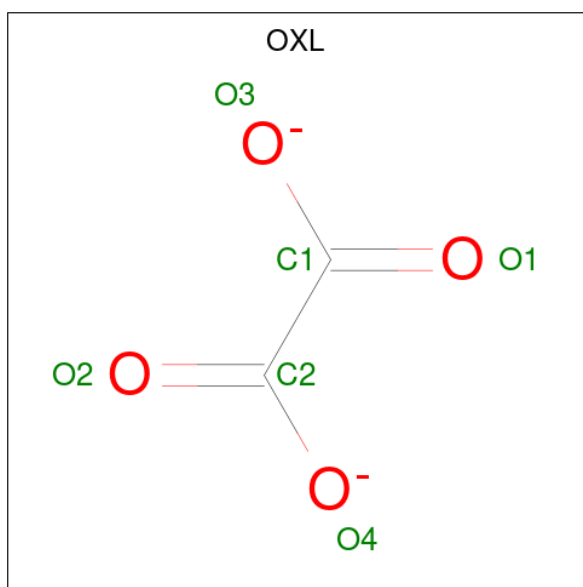

Mol	Chain	Residues	Atoms		ZeroOcc	AltConf
5	A	1	Total	C O	0	0
			6	2 4		
5	B	1	Total	C O	0	0
			6	2 4		
5	C	1	Total	C O	0	0
			6	2 4		
5	D	1	Total	C O	0	0
			6	2 4		

- Molecule 6 is 1,2-ETHANEDIOL (three-letter code: EDO) (formula: $C_2H_6O_2$).

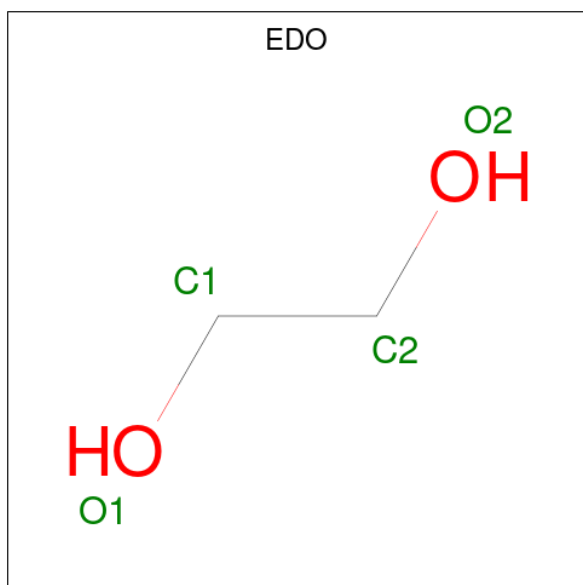

Mol	Chain	Residues	Atoms	ZeroOcc	AltConf
6	A	1	Total C O 4 2 2	0	0
6	A	1	Total C O 4 2 2	0	0
6	A	1	Total C O 4 2 2	0	0
6	A	1	Total C O 4 2 2	0	0
6	A	1	Total C O 4 2 2	0	0
6	A	1	Total C O 4 2 2	0	0
6	A	1	Total C O 4 2 2	0	0
6	B	1	Total C O 4 2 2	0	0
6	B	1	Total C O 4 2 2	0	0
6	B	1	Total C O 4 2 2	0	0
6	B	1	Total C O 4 2 2	0	0
6	B	1	Total C O 4 2 2	0	0
6	B	1	Total C O 4 2 2	0	0
6	B	1	Total C O 4 2 2	0	0
6	B	1	Total C O 4 2 2	0	0
6	B	1	Total C O 4 2 2	0	0
6	C	1	Total C O 4 2 2	0	0
6	C	1	Total C O 4 2 2	0	0
6	C	1	Total C O 4 2 2	0	0
6	C	1	Total C O 4 2 2	0	0
6	C	1	Total C O 4 2 2	0	0
6	C	1	Total C O 4 2 2	0	0

Continued on next page...

Continued from previous page...

Mol	Chain	Residues	Atoms	ZeroOcc	AltConf
6	C	1	Total C O 4 2 2	0	0
6	C	1	Total C O 4 2 2	0	0
6	C	1	Total C O 4 2 2	0	0
6	D	1	Total C O 4 2 2	0	0
6	D	1	Total C O 4 2 2	0	0
6	D	1	Total C O 4 2 2	0	0
6	D	1	Total C O 4 2 2	0	0
6	D	1	Total C O 4 2 2	0	0
6	D	1	Total C O 4 2 2	0	0
6	D	1	Total C O 4 2 2	0	0
6	D	1	Total C O 4 2 2	0	0
6	D	1	Total C O 4 2 2	0	0

- Molecule 7 is DI(HYDROXYETHYL)ETHER (three-letter code: PEG) (formula: C₄H₁₀O₃).

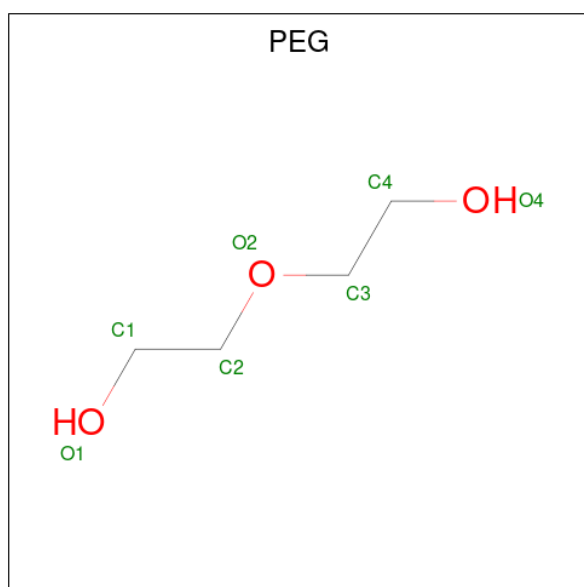

Mol	Chain	Residues	Atoms			ZeroOcc	AltConf
7	A	1	Total	C	O	0	0
			7	4	3		
7	D	1	Total	C	O	0	0
			7	4	3		

- Molecule 8 is TETRAETHYLENE GLYCOL (three-letter code: PG4) (formula: C₈H₁₈O₅).

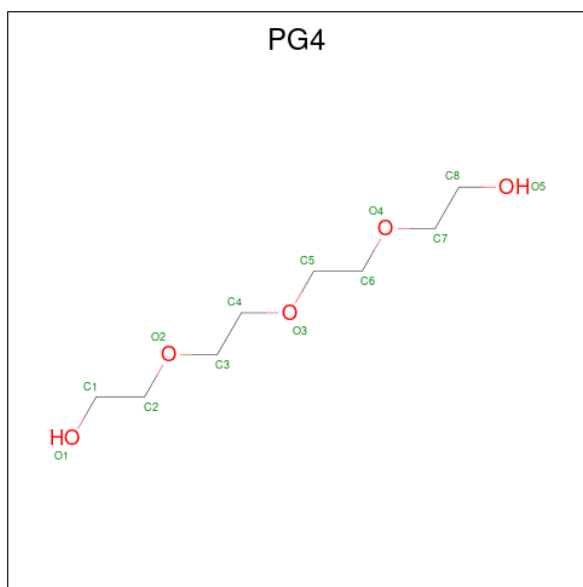

Mol	Chain	Residues	Atoms			ZeroOcc	AltConf
8	A	1	Total	C	O	0	0
			13	8	5		

- Molecule 9 is TRIETHYLENE GLYCOL (three-letter code: PGE) (formula: C₆H₁₄O₄).

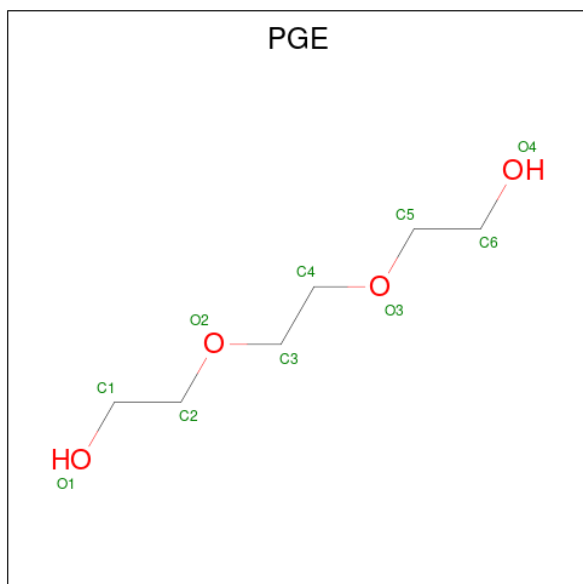

Mol	Chain	Residues	Atoms			ZeroOcc	AltConf
9	B	1	Total	C	O	0	0
			10	6	4		

- Molecule 10 is CHLORIDE ION (three-letter code: CL) (formula: Cl).

Mol	Chain	Residues	Atoms		ZeroOcc	AltConf
10	D	1	Total	Cl	0	0
			1	1		

- Molecule 11 is water.

Mol	Chain	Residues	Atoms		ZeroOcc	AltConf
11	A	320	Total	O	0	0
			320	320		
11	B	281	Total	O	0	0
			281	281		
11	C	306	Total	O	0	0
			306	306		
11	D	294	Total	O	0	0
			294	294		

3 Residue-property plots [i](#)

These plots are drawn for all protein, RNA, DNA and oligosaccharide chains in the entry. The first graphic for a chain summarises the proportions of the various outlier classes displayed in the second graphic. The second graphic shows the sequence view annotated by issues in geometry and electron density. Residues are color-coded according to the number of geometric quality criteria for which they contain at least one outlier: green = 0, yellow = 1, orange = 2 and red = 3 or more. A red dot above a residue indicates a poor fit to the electron density ($RSRZ > 2$). Stretches of 2 or more consecutive residues without any outlier are shown as a green connector. Residues present in the sample, but not in the model, are shown in grey.

- Molecule 1: Pyruvate kinase PKLR

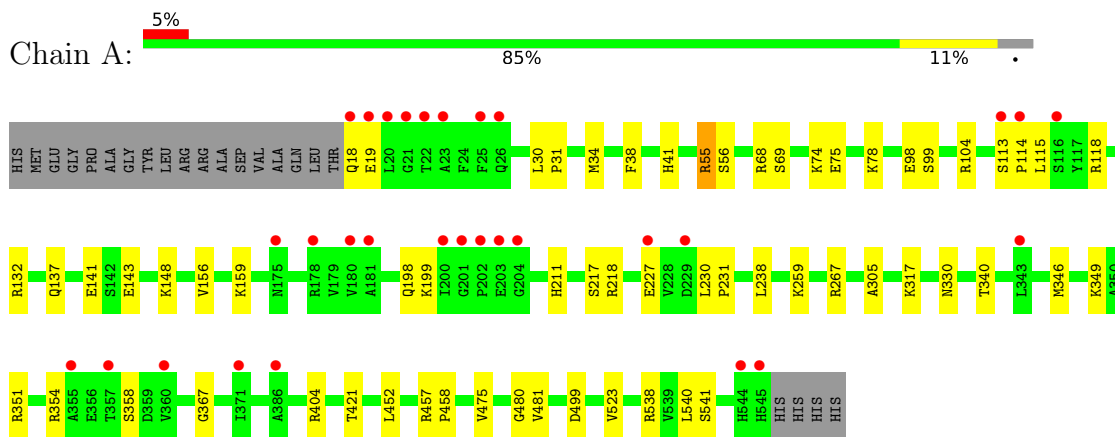

- Molecule 1: Pyruvate kinase PKLR

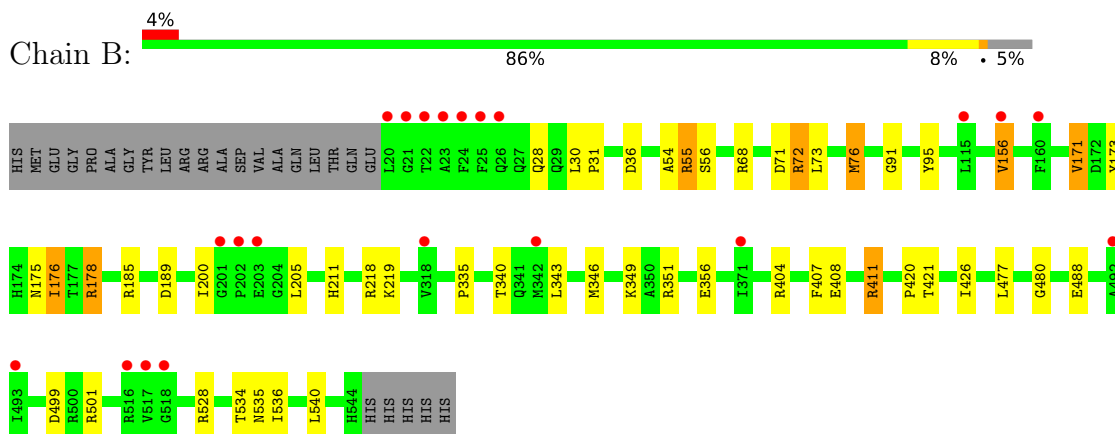

- Molecule 1: Pyruvate kinase PKLR

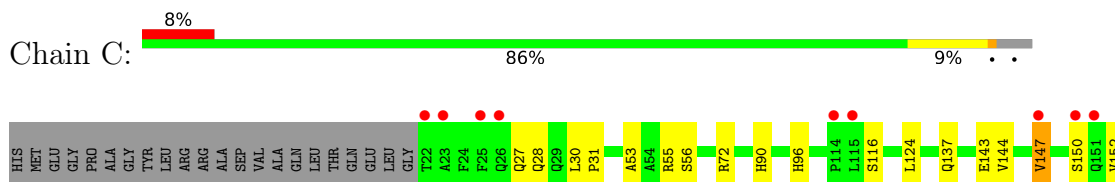

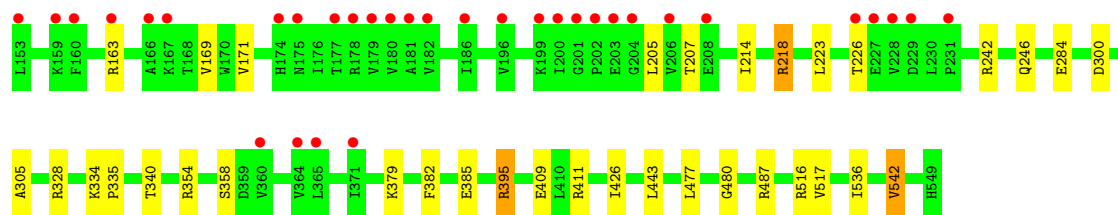

● Molecule 1: Pyruvate kinase PKLR

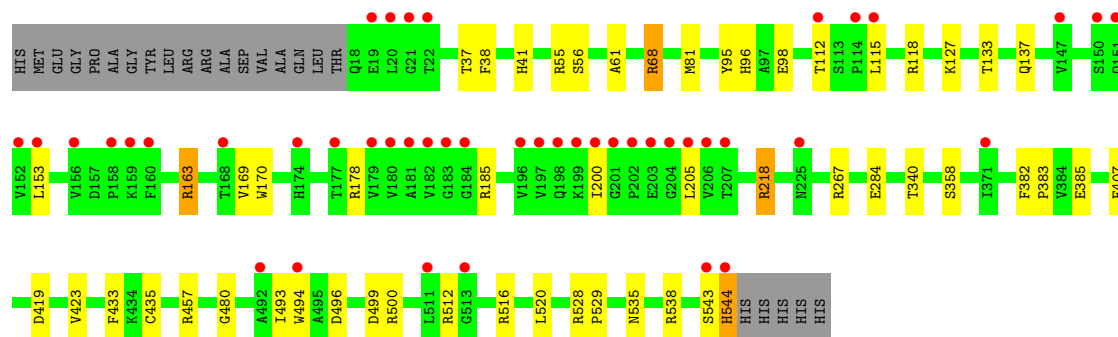
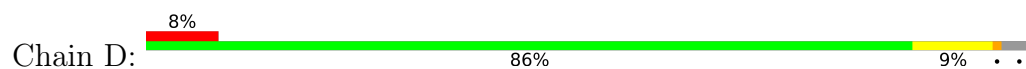

4 Data and refinement statistics

Property	Value	Source
Space group	P 21 21 21	Depositor
Cell constants a, b, c, α , β , γ	86.55Å 108.90Å 296.84Å 90.00° 90.00° 90.00°	Depositor
Resolution (Å)	49.52 – 2.19 49.47 – 2.19	Depositor EDS
% Data completeness (in resolution range)	99.9 (49.52-2.19) 100.0 (49.47-2.19)	Depositor EDS
R_{merge}	0.09	Depositor
R_{sym}	(Not available)	Depositor
$\langle I/\sigma(I) \rangle$ ¹	1.66 (at 2.18Å)	Xtrriage
Refinement program	REFMAC 5.8.0230	Depositor
R, R_{free}	0.181 , 0.238 0.189 , 0.241	Depositor DCC
R_{free} test set	7124 reflections (4.92%)	wwPDB-VP
Wilson B-factor (Å ²)	41.7	Xtrriage
Anisotropy	0.063	Xtrriage
Bulk solvent k_{sol} (e/Å ³), B_{sol} (Å ²)	0.32 , 37.6	EDS
L-test for twinning ²	$\langle L \rangle = 0.49$, $\langle L^2 \rangle = 0.32$	Xtrriage
Estimated twinning fraction	No twinning to report.	Xtrriage
F_o, F_c correlation	0.96	EDS
Total number of atoms	17686	wwPDB-VP
Average B, all atoms (Å ²)	47.0	wwPDB-VP

Xtrriage's analysis on translational NCS is as follows: *The largest off-origin peak in the Patterson function is 2.24% of the height of the origin peak. No significant pseudotranslation is detected.*

¹Intensities estimated from amplitudes.

²Theoretical values of $\langle |L| \rangle$, $\langle L^2 \rangle$ for acentric reflections are 0.5, 0.333 respectively for untwinned datasets, and 0.375, 0.2 for perfectly twinned datasets.

5 Model quality [i](#)

5.1 Standard geometry [i](#)

Bond lengths and bond angles in the following residue types are not validated in this section: PG4, EDO, PEG, CL, PGE, OXL, FBP, ATP, MG

The Z score for a bond length (or angle) is the number of standard deviations the observed value is removed from the expected value. A bond length (or angle) with $|Z| > 5$ is considered an outlier worth inspection. RMSZ is the root-mean-square of all Z scores of the bond lengths (or angles).

Mol	Chain	Bond lengths		Bond angles	
		RMSZ	# Z >5	RMSZ	# Z >5
1	A	0.57	0/4104	0.69	0/5560
1	B	0.56	0/4066	0.70	1/5509 (0.0%)
1	C	0.55	0/4125	0.70	0/5587
1	D	0.55	0/4077	0.69	1/5523 (0.0%)
All	All	0.56	0/16372	0.69	2/22179 (0.0%)

Chiral center outliers are detected by calculating the chiral volume of a chiral center and verifying if the center is modelled as a planar moiety or with the opposite hand. A planarity outlier is detected by checking planarity of atoms in a peptide group, atoms in a mainchain group or atoms of a sidechain that are expected to be planar.

Mol	Chain	#Chirality outliers	#Planarity outliers
1	A	0	6
1	B	0	4
1	C	0	4
1	D	0	5
All	All	0	19

There are no bond length outliers.

All (2) bond angle outliers are listed below:

Mol	Chain	Res	Type	Atoms	Z	Observed(°)	Ideal(°)
1	D	68	ARG	NE-CZ-NH2	-5.63	117.48	120.30
1	B	72	ARG	CG-CD-NE	-5.51	100.22	111.80

There are no chirality outliers.

5 of 19 planarity outliers are listed below:

Mol	Chain	Res	Type	Group
1	A	104	ARG	Sidechain
1	A	132	ARG	Sidechain
1	A	218	ARG	Sidechain
1	A	267	ARG	Sidechain
1	A	55	ARG	Sidechain

5.2 Too-close contacts [i](#)

In the following table, the Non-H and H(model) columns list the number of non-hydrogen atoms and hydrogen atoms in the chain respectively. The H(added) column lists the number of hydrogen atoms added and optimized by MolProbity. The Clashes column lists the number of clashes within the asymmetric unit, whereas Symm-Clashes lists symmetry-related clashes.

Mol	Chain	Non-H	H(model)	H(added)	Clashes	Symm-Clashes
1	A	4038	0	4098	40	0
1	B	4001	0	4072	37	0
1	C	4054	0	4105	36	0
1	D	4012	0	4080	27	0
2	A	20	0	10	0	0
2	B	20	0	10	2	0
2	C	20	0	10	0	0
2	D	20	0	10	0	0
3	A	4	0	0	0	0
3	B	4	0	0	0	0
3	C	2	0	0	0	0
3	D	3	0	0	0	0
4	A	31	0	12	0	0
4	B	31	0	12	0	0
4	D	31	0	12	0	0
5	A	6	0	0	1	0
5	B	6	0	0	0	0
5	C	6	0	0	0	0
5	D	6	0	0	0	0
6	A	28	0	42	9	0
6	B	36	0	54	5	0
6	C	36	0	54	7	0
6	D	32	0	48	3	0
7	A	7	0	10	3	0
7	D	7	0	10	0	0
8	A	13	0	18	2	0
9	B	10	0	14	5	0
10	D	1	0	0	0	0
11	A	320	0	0	10	0

Continued on next page...

Continued from previous page...

Mol	Chain	Non-H	H(model)	H(added)	Clashes	Symm-Clashes
11	B	281	0	0	8	0
11	C	306	0	0	8	0
11	D	294	0	0	7	0
All	All	17686	0	16681	142	0

The all-atom clashscore is defined as the number of clashes found per 1000 atoms (including hydrogen atoms). The all-atom clashscore for this structure is 4.

The worst 5 of 142 close contacts within the same asymmetric unit are listed below, sorted by their clash magnitude.

Atom-1	Atom-2	Interatomic distance (Å)	Clash overlap (Å)
1:C:382:PHE:HB3	1:C:385:GLU:HG2	1.63	0.80
1:D:435:CYS:HB2	1:D:520:LEU:HD12	1.68	0.76
1:C:354:ARG:HH12	6:C:608:EDO:H11	1.52	0.73
1:C:242:ARG:CZ	11:C:702:HOH:O	2.37	0.71
1:C:242:ARG:NE	11:C:702:HOH:O	2.26	0.68

There are no symmetry-related clashes.

5.3 Torsion angles [i](#)

5.3.1 Protein backbone [i](#)

In the following table, the Percentiles column shows the percent Ramachandran outliers of the chain as a percentile score with respect to all X-ray entries followed by that with respect to entries of similar resolution.

The Analysed column shows the number of residues for which the backbone conformation was analysed, and the total number of residues.

Mol	Chain	Analysed	Favoured	Allowed	Outliers	Percentiles
1	A	528/550 (96%)	512 (97%)	14 (3%)	2 (0%)	34 37
1	B	524/550 (95%)	513 (98%)	9 (2%)	2 (0%)	34 37
1	C	528/550 (96%)	517 (98%)	10 (2%)	1 (0%)	47 55
1	D	525/550 (96%)	508 (97%)	14 (3%)	3 (1%)	25 26
All	All	2105/2200 (96%)	2050 (97%)	47 (2%)	8 (0%)	34 37

5 of 8 Ramachandran outliers are listed below:

Mol	Chain	Res	Type
1	A	114	PRO
1	A	340	THR
1	B	340	THR
1	B	535	ASN
1	C	340	THR

5.3.2 Protein sidechains [i](#)

In the following table, the Percentiles column shows the percent sidechain outliers of the chain as a percentile score with respect to all X-ray entries followed by that with respect to entries of similar resolution.

The Analysed column shows the number of residues for which the sidechain conformation was analysed, and the total number of residues.

Mol	Chain	Analysed	Rotameric	Outliers	Percentiles	
1	A	432/446 (97%)	418 (97%)	14 (3%)	39	50
1	B	428/446 (96%)	418 (98%)	10 (2%)	50	63
1	C	433/446 (97%)	419 (97%)	14 (3%)	39	50
1	D	429/446 (96%)	417 (97%)	12 (3%)	43	56
All	All	1722/1784 (96%)	1672 (97%)	50 (3%)	42	54

5 of 50 residues with a non-rotameric sidechain are listed below:

Mol	Chain	Res	Type
1	C	152	VAL
1	C	379	LYS
1	D	544	HIS
1	C	169	VAL
1	C	223	LEU

Sometimes sidechains can be flipped to improve hydrogen bonding and reduce clashes. 5 of 26 such sidechains are listed below:

Mol	Chain	Res	Type
1	C	286	HIS
1	D	28	GLN
1	D	503	GLN
1	C	546	HIS
1	D	96	HIS

5.3.3 RNA [i](#)

There are no RNA molecules in this entry.

5.4 Non-standard residues in protein, DNA, RNA chains [i](#)

There are no non-standard protein/DNA/RNA residues in this entry.

5.5 Carbohydrates [i](#)

There are no monosaccharides in this entry.

5.6 Ligand geometry [i](#)

Of 62 ligands modelled in this entry, 14 are monoatomic - leaving 48 for Mogul analysis.

In the following table, the Counts columns list the number of bonds (or angles) for which Mogul statistics could be retrieved, the number of bonds (or angles) that are observed in the model and the number of bonds (or angles) that are defined in the Chemical Component Dictionary. The Link column lists molecule types, if any, to which the group is linked. The Z score for a bond length (or angle) is the number of standard deviations the observed value is removed from the expected value. A bond length (or angle) with $|Z| > 2$ is considered an outlier worth inspection. RMSZ is the root-mean-square of all Z scores of the bond lengths (or angles).

Mol	Type	Chain	Res	Link	Bond lengths			Bond angles		
					Counts	RMSZ	# Z > 2	Counts	RMSZ	# Z > 2
9	PGE	B	608	-	9,9,9	0.90	0	8,8,8	1.22	1 (12%)
6	EDO	A	608	-	3,3,3	0.83	0	2,2,2	0.93	0
6	EDO	B	613	-	3,3,3	0.75	0	2,2,2	0.65	0
6	EDO	C	607	-	3,3,3	0.82	0	2,2,2	0.51	0
6	EDO	C	613	-	3,3,3	0.67	0	2,2,2	0.21	0
6	EDO	A	610	-	3,3,3	0.90	0	2,2,2	0.82	0
6	EDO	C	612	-	3,3,3	0.55	0	2,2,2	0.15	0
4	ATP	B	606	3	26,33,33	1.00	1 (3%)	31,52,52	1.62	7 (22%)
6	EDO	B	617	-	3,3,3	0.47	0	2,2,2	0.61	0
6	EDO	A	611	-	3,3,3	0.42	0	2,2,2	0.43	0
4	ATP	A	606	3	26,33,33	1.07	2 (7%)	31,52,52	1.62	4 (12%)
6	EDO	B	614	-	3,3,3	0.40	0	2,2,2	0.90	0
6	EDO	C	610	-	3,3,3	0.55	0	2,2,2	0.87	0
4	ATP	D	605	3	26,33,33	1.13	3 (11%)	31,52,52	1.58	6 (19%)
6	EDO	A	609	-	3,3,3	0.59	0	2,2,2	0.30	0
6	EDO	B	612	-	3,3,3	0.42	0	2,2,2	0.63	0
6	EDO	A	612	-	3,3,3	0.74	0	2,2,2	0.49	0

Mol	Type	Chain	Res	Link	Bond lengths			Bond angles		
					Counts	RMSZ	# Z > 2	Counts	RMSZ	# Z > 2
6	EDO	B	611	-	3,3,3	0.49	0	2,2,2	0.25	0
6	EDO	B	610	-	3,3,3	0.57	0	2,2,2	0.35	0
7	PEG	A	615	-	6,6,6	1.15	0	5,5,5	1.10	0
6	EDO	D	608	-	3,3,3	0.80	0	2,2,2	0.52	0
6	EDO	C	605	-	3,3,3	0.39	0	2,2,2	0.45	0
2	FBP	B	601	-	18,20,20	0.75	0	23,32,32	1.37	4 (17%)
5	OXL	A	607	3	5,5,5	1.81	1 (20%)	6,6,6	1.28	0
6	EDO	C	608	-	3,3,3	0.59	0	2,2,2	0.54	0
6	EDO	D	611	-	3,3,3	0.44	0	2,2,2	0.59	0
5	OXL	D	606	3	5,5,5	1.82	2 (40%)	6,6,6	0.86	0
6	EDO	B	616	-	3,3,3	0.72	0	2,2,2	0.21	0
6	EDO	D	609	-	3,3,3	0.57	0	2,2,2	0.39	0
6	EDO	D	610	-	3,3,3	0.23	0	2,2,2	0.87	0
6	EDO	D	613	-	3,3,3	0.43	0	2,2,2	0.37	0
2	FBP	D	601	-	18,20,20	0.92	0	23,32,32	1.60	5 (21%)
2	FBP	A	601	-	18,20,20	0.94	1 (5%)	23,32,32	1.29	3 (13%)
6	EDO	C	606	-	3,3,3	0.28	0	2,2,2	0.49	0
8	PG4	A	616	-	12,12,12	0.61	0	11,11,11	0.98	1 (9%)
5	OXL	C	604	3	5,5,5	1.54	1 (20%)	6,6,6	1.77	2 (33%)
6	EDO	D	612	-	3,3,3	0.40	0	2,2,2	0.80	0
6	EDO	A	613	-	3,3,3	0.77	0	2,2,2	0.23	0
2	FBP	C	601	-	18,20,20	0.65	0	23,32,32	1.12	1 (4%)
6	EDO	D	607	-	3,3,3	0.37	0	2,2,2	0.57	0
7	PEG	D	615	-	6,6,6	0.67	0	5,5,5	0.64	0
5	OXL	B	607	3	5,5,5	1.71	1 (20%)	6,6,6	2.52	4 (66%)
6	EDO	C	611	-	3,3,3	0.60	0	2,2,2	0.52	0
6	EDO	A	614	-	3,3,3	0.57	0	2,2,2	0.34	0
6	EDO	B	609	-	3,3,3	0.35	0	2,2,2	0.66	0
6	EDO	C	609	-	3,3,3	0.61	0	2,2,2	0.19	0
6	EDO	B	615	-	3,3,3	0.38	0	2,2,2	0.57	0
6	EDO	D	614	-	3,3,3	0.40	0	2,2,2	0.46	0

In the following table, the Chirals column lists the number of chiral outliers, the number of chiral centers analysed, the number of these observed in the model and the number defined in the Chemical Component Dictionary. Similar counts are reported in the Torsion and Rings columns. '-' means no outliers of that kind were identified.

Mol	Type	Chain	Res	Link	Chirals	Torsions	Rings
9	PGE	B	608	-	-	4/7/7/7	-
6	EDO	A	608	-	-	0/1/1/1	-

Continued on next page...

Continued from previous page...

Mol	Type	Chain	Res	Link	Chirals	Torsions	Rings
6	EDO	B	613	-	-	1/1/1/1	-
6	EDO	C	607	-	-	0/1/1/1	-
6	EDO	C	613	-	-	1/1/1/1	-
6	EDO	A	610	-	-	1/1/1/1	-
6	EDO	C	612	-	-	1/1/1/1	-
4	ATP	B	606	3	-	4/18/38/38	0/3/3/3
6	EDO	B	617	-	-	0/1/1/1	-
6	EDO	A	611	-	-	1/1/1/1	-
4	ATP	A	606	3	-	1/18/38/38	0/3/3/3
6	EDO	B	614	-	-	1/1/1/1	-
6	EDO	C	610	-	-	1/1/1/1	-
4	ATP	D	605	3	-	5/18/38/38	0/3/3/3
6	EDO	A	609	-	-	0/1/1/1	-
6	EDO	B	612	-	-	0/1/1/1	-
6	EDO	A	612	-	-	1/1/1/1	-
6	EDO	B	611	-	-	1/1/1/1	-
6	EDO	B	610	-	-	1/1/1/1	-
7	PEG	A	615	-	-	1/4/4/4	-
6	EDO	D	608	-	-	0/1/1/1	-
6	EDO	C	605	-	-	1/1/1/1	-
2	FBP	B	601	-	-	2/13/32/32	0/1/1/1
5	OXL	A	607	3	-	0/4/4/4	-
6	EDO	C	608	-	-	1/1/1/1	-
6	EDO	D	611	-	-	1/1/1/1	-
5	OXL	D	606	3	-	1/4/4/4	-
6	EDO	B	616	-	-	1/1/1/1	-
6	EDO	D	609	-	-	1/1/1/1	-
6	EDO	D	610	-	-	0/1/1/1	-
6	EDO	D	613	-	-	1/1/1/1	-
2	FBP	D	601	-	-	3/13/32/32	0/1/1/1
2	FBP	A	601	-	-	2/13/32/32	0/1/1/1
6	EDO	C	606	-	-	1/1/1/1	-
8	PG4	A	616	-	-	6/10/10/10	-
5	OXL	C	604	3	-	0/4/4/4	-
6	EDO	D	612	-	-	0/1/1/1	-
6	EDO	A	613	-	-	1/1/1/1	-
2	FBP	C	601	-	-	2/13/32/32	0/1/1/1
6	EDO	D	607	-	-	1/1/1/1	-
7	PEG	D	615	-	-	1/4/4/4	-
5	OXL	B	607	3	-	0/4/4/4	-
6	EDO	C	611	-	-	1/1/1/1	-

Continued on next page...

Continued from previous page...

Mol	Type	Chain	Res	Link	Chirals	Torsions	Rings
6	EDO	A	614	-	-	1/1/1/1	-
6	EDO	B	609	-	-	0/1/1/1	-
6	EDO	C	609	-	-	0/1/1/1	-
6	EDO	B	615	-	-	1/1/1/1	-
6	EDO	D	614	-	-	0/1/1/1	-

The worst 5 of 12 bond length outliers are listed below:

Mol	Chain	Res	Type	Atoms	Z	Observed(Å)	Ideal(Å)
4	A	606	ATP	O4'-C1'	3.01	1.45	1.41
5	B	607	OXL	C2-C1	-2.81	1.46	1.54
4	B	606	ATP	C5-C4	2.80	1.48	1.40
5	A	607	OXL	C2-C1	-2.69	1.46	1.54
4	D	605	ATP	C5-C4	2.62	1.47	1.40

The worst 5 of 38 bond angle outliers are listed below:

Mol	Chain	Res	Type	Atoms	Z	Observed(°)	Ideal(°)
4	D	605	ATP	N3-C2-N1	-3.82	122.70	128.68
4	A	606	ATP	O3G-PG-O2G	3.80	122.14	107.64
4	A	606	ATP	N3-C2-N1	-3.56	123.12	128.68
4	B	606	ATP	N3-C2-N1	-3.50	123.20	128.68
5	B	607	OXL	O1-C1-C2	-3.47	109.64	120.78

There are no chirality outliers.

5 of 54 torsion outliers are listed below:

Mol	Chain	Res	Type	Atoms
2	A	601	FBP	C4-C5-C6-O6
2	C	601	FBP	C4-C5-C6-O6
4	B	606	ATP	PB-O3B-PG-O3G
8	A	616	PG4	C1-C2-O2-C3
2	B	601	FBP	C4-C5-C6-O6

There are no ring outliers.

16 monomers are involved in 37 short contacts:

Mol	Chain	Res	Type	Clashes	Symm-Clashes
9	B	608	PGE	5	0
6	A	608	EDO	3	0
6	A	610	EDO	1	0

Continued on next page...

Continued from previous page...

Mol	Chain	Res	Type	Clashes	Symm-Clashes
6	A	611	EDO	2	0
6	A	612	EDO	3	0
6	B	611	EDO	2	0
6	B	610	EDO	3	0
7	A	615	PEG	3	0
2	B	601	FBP	2	0
5	A	607	OXL	1	0
6	C	608	EDO	2	0
6	D	613	EDO	2	0
8	A	616	PG4	2	0
6	A	613	EDO	1	0
6	D	607	EDO	1	0
6	C	611	EDO	5	0

The following is a two-dimensional graphical depiction of Mogul quality analysis of bond lengths, bond angles, torsion angles, and ring geometry for all instances of the Ligand of Interest. In addition, ligands with molecular weight > 250 and outliers as shown on the validation Tables will also be included. For torsion angles, if less than 5% of the Mogul distribution of torsion angles is within 10 degrees of the torsion angle in question, then that torsion angle is considered an outlier. Any bond that is central to one or more torsion angles identified as an outlier by Mogul will be highlighted in the graph. For rings, the root-mean-square deviation (RMSD) between the ring in question and similar rings identified by Mogul is calculated over all ring torsion angles. If the average RMSD is greater than 60 degrees and the minimal RMSD between the ring in question and any Mogul-identified rings is also greater than 60 degrees, then that ring is considered an outlier. The outliers are highlighted in purple. The color gray indicates Mogul did not find sufficient equivalents in the CSD to analyse the geometry.

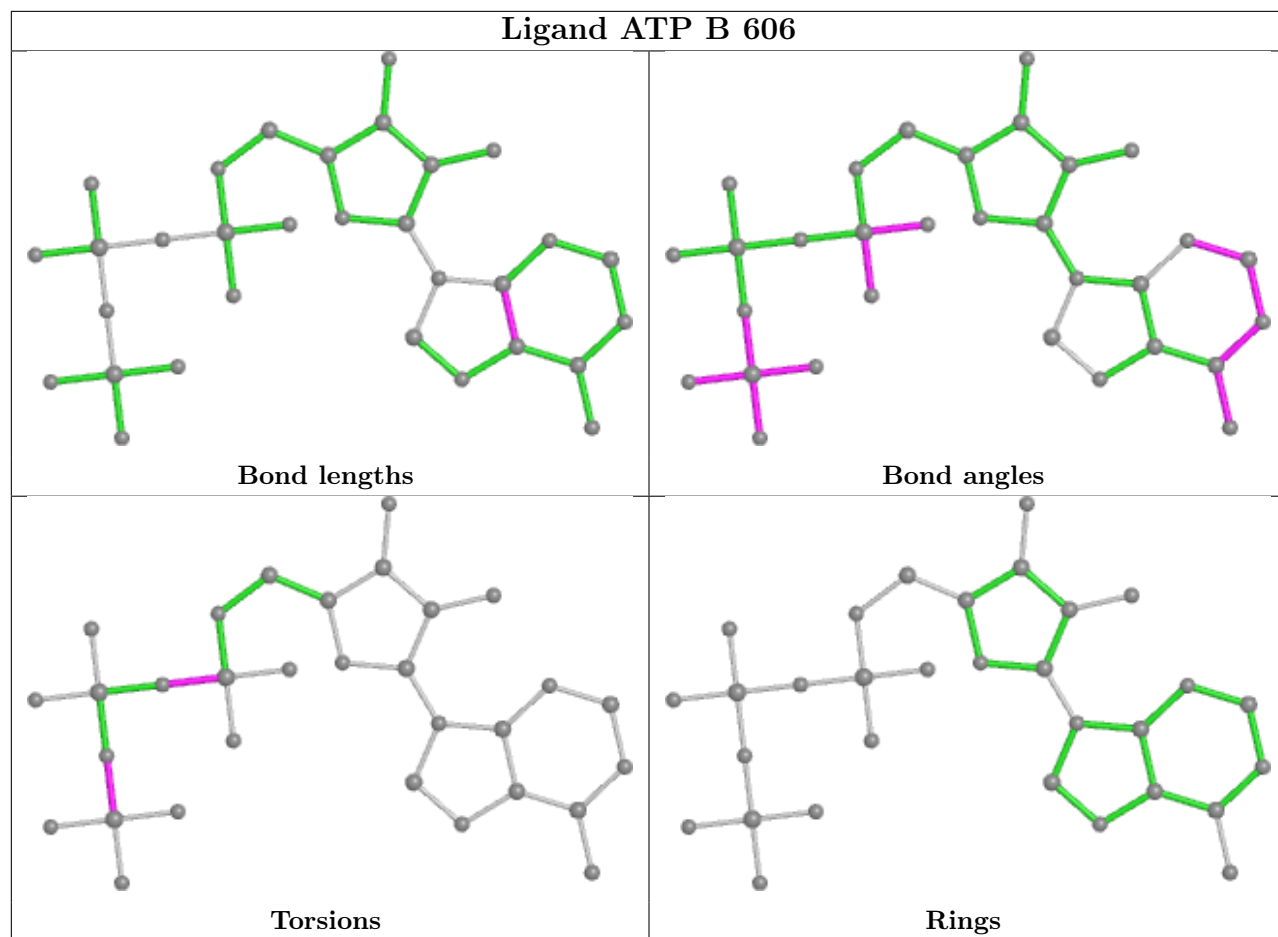

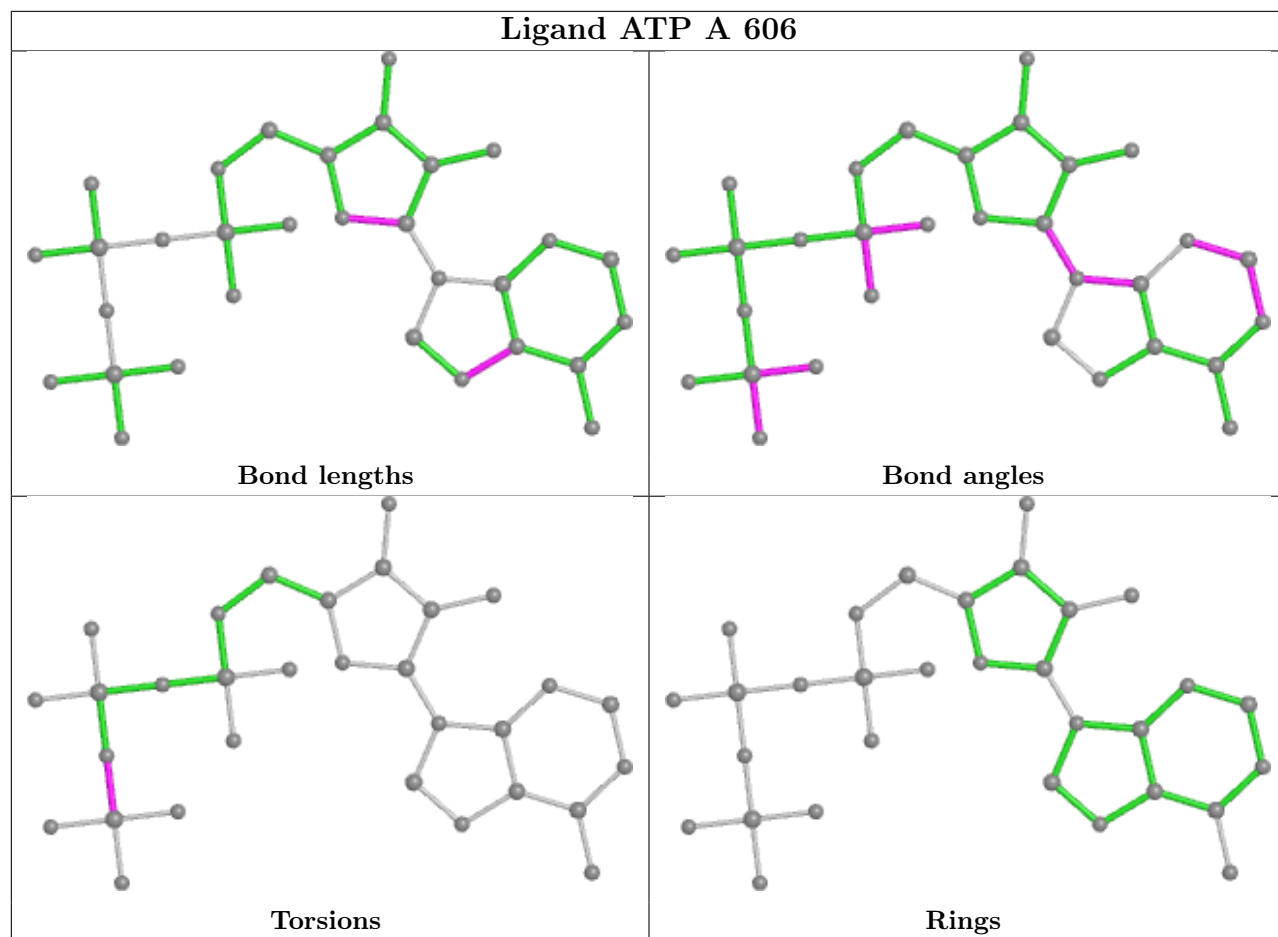

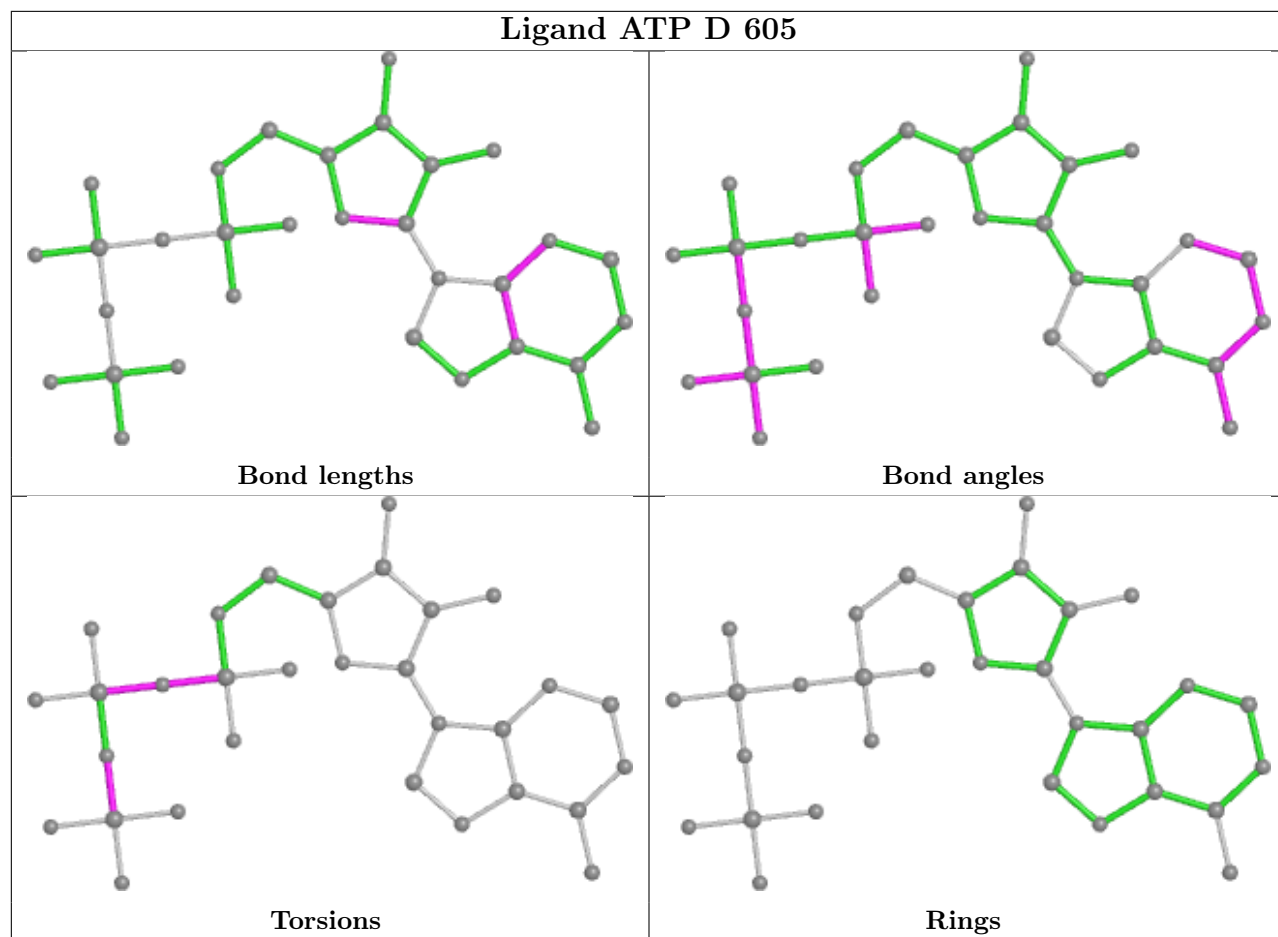

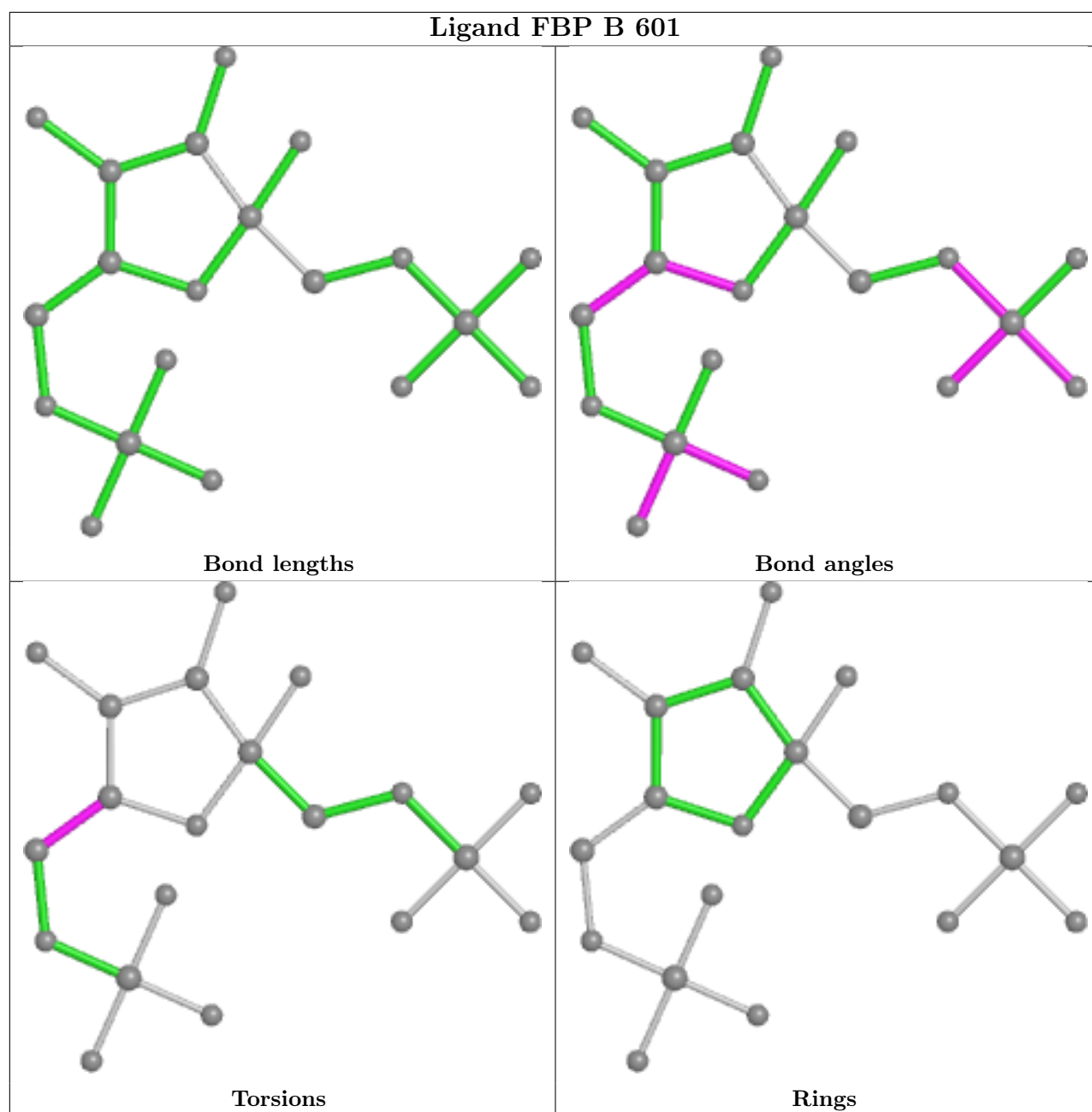

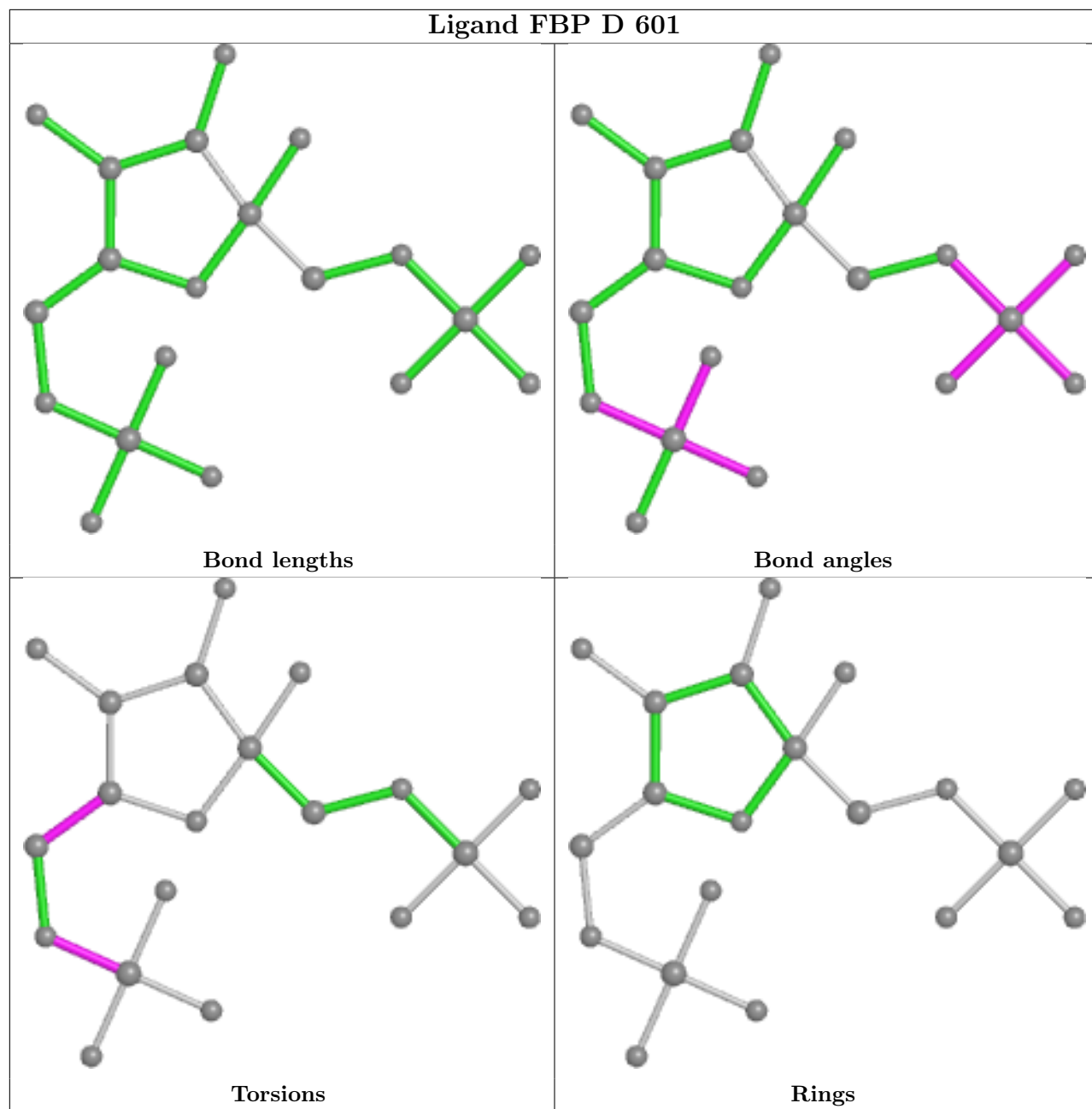

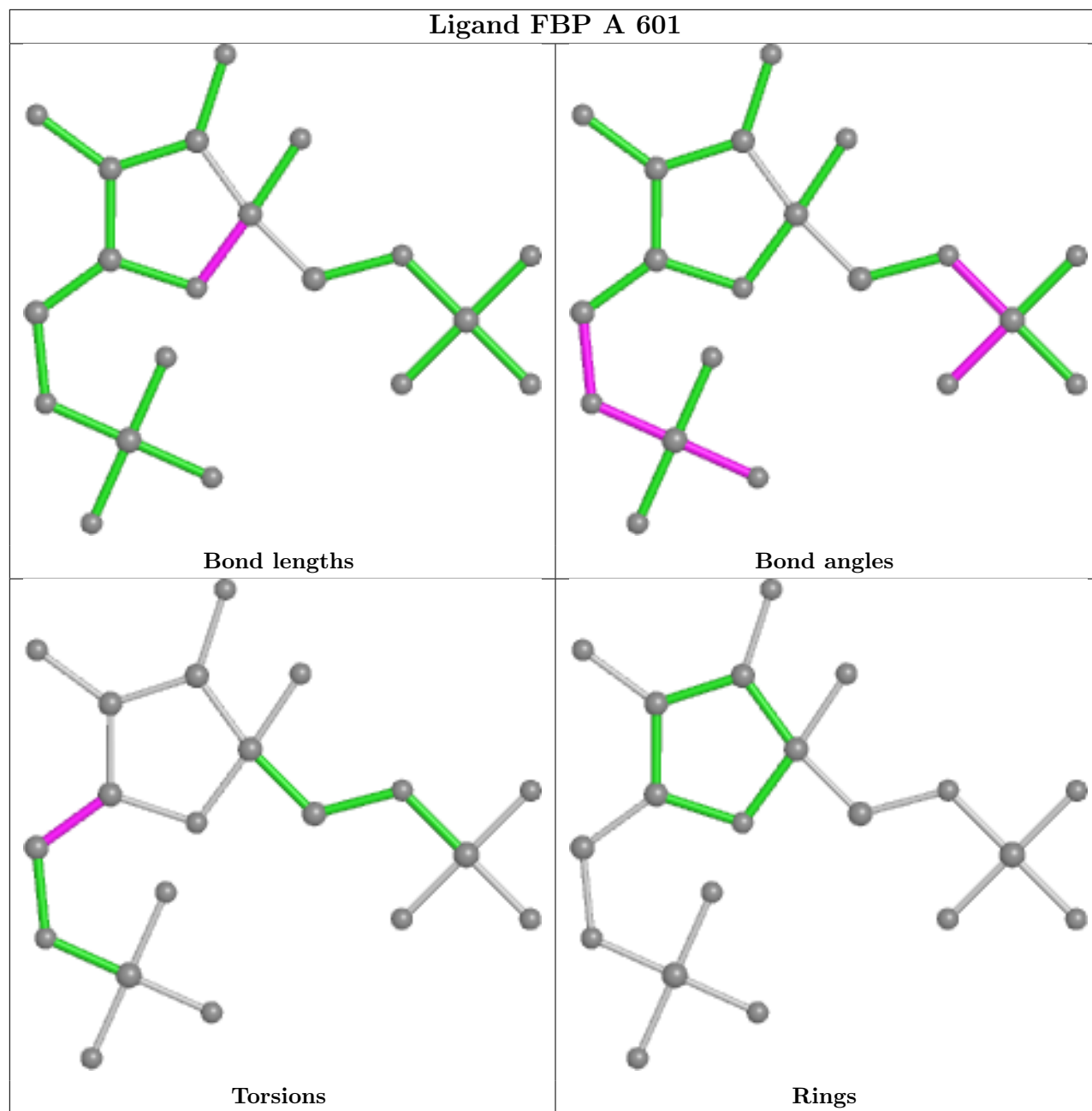

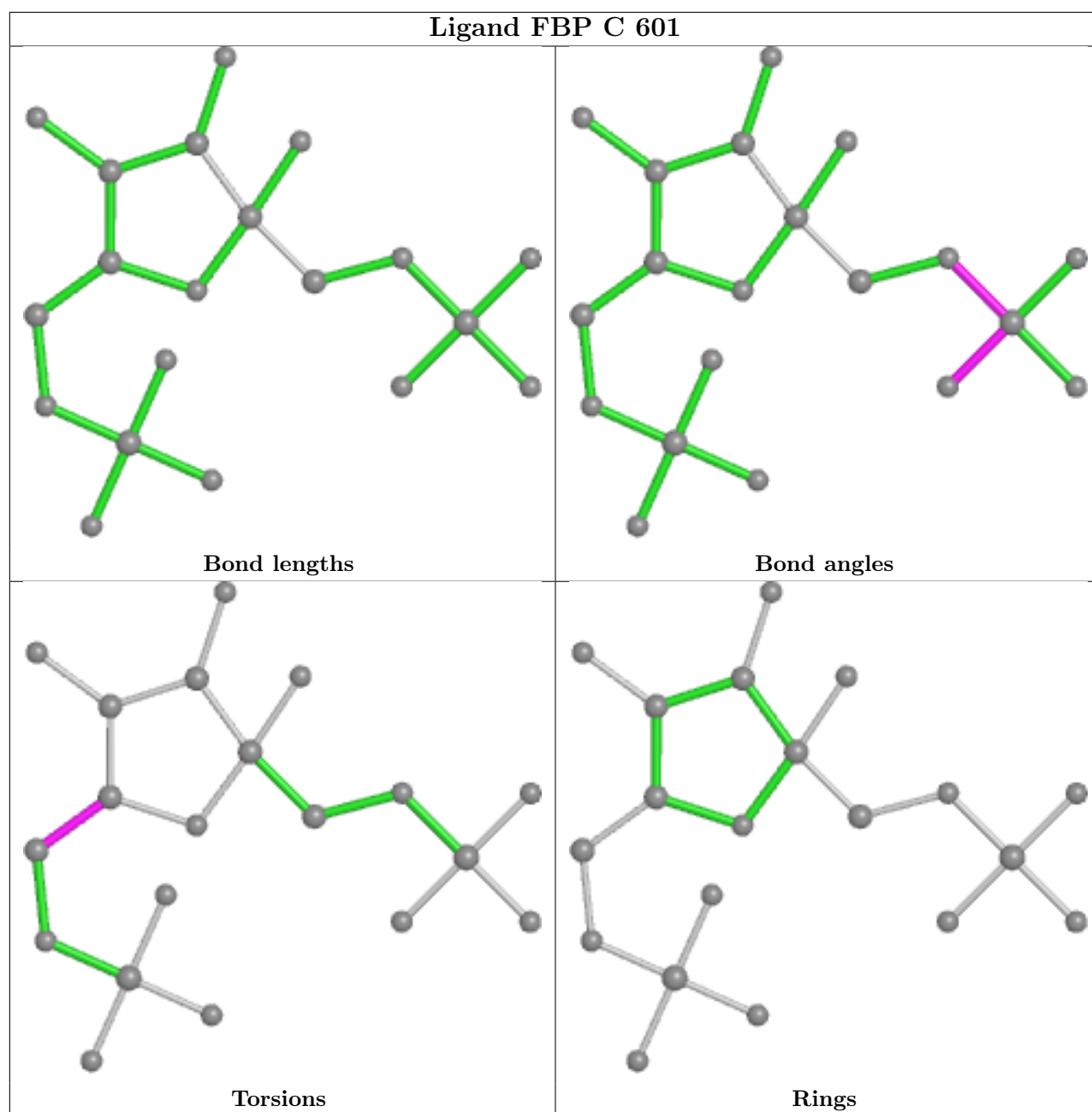

5.7 Other polymers [i](#)

There are no such residues in this entry.

5.8 Polymer linkage issues [i](#)

There are no chain breaks in this entry.

6 Fit of model and data [i](#)

6.1 Protein, DNA and RNA chains [i](#)

In the following table, the column labelled ‘#RSRZ > 2’ contains the number (and percentage) of RSRZ outliers, followed by percent RSRZ outliers for the chain as percentile scores relative to all X-ray entries and entries of similar resolution. The OWAB column contains the minimum, median, 95th percentile and maximum values of the occupancy-weighted average B-factor per residue. The column labelled ‘Q < 0.9’ lists the number of (and percentage) of residues with an average occupancy less than 0.9.

Mol	Chain	Analysed	<RSRZ>	#RSRZ>2	OWAB(Å ²)	Q<0.9
1	A	528/550 (96%)	0.07	30 (5%) 23 22	27, 40, 73, 110	0
1	B	525/550 (95%)	0.08	21 (4%) 38 36	30, 44, 70, 106	0
1	C	528/550 (96%)	0.22	42 (7%) 12 11	29, 42, 76, 123	0
1	D	527/550 (95%)	0.28	45 (8%) 10 9	29, 44, 77, 124	0
All	All	2108/2200 (95%)	0.16	138 (6%) 18 17	27, 43, 74, 124	0

The worst 5 of 138 RSRZ outliers are listed below:

Mol	Chain	Res	Type	RSRZ
1	D	115	LEU	7.4
1	B	22	THR	6.2
1	C	229	ASP	6.2
1	C	228	VAL	5.9
1	D	181	ALA	5.4

6.2 Non-standard residues in protein, DNA, RNA chains [i](#)

There are no non-standard protein/DNA/RNA residues in this entry.

6.3 Carbohydrates [i](#)

There are no monosaccharides in this entry.

6.4 Ligands [i](#)

In the following table, the Atoms column lists the number of modelled atoms in the group and the number defined in the chemical component dictionary. The B-factors column lists the minimum, median, 95th percentile and maximum values of B factors of atoms in the group. The column labelled ‘Q < 0.9’ lists the number of atoms with occupancy less than 0.9.

Mol	Type	Chain	Res	Atoms	RSCC	RSR	B-factors(\AA^2)	Q<0.9
6	EDO	C	609	4/4	0.57	0.24	75,82,85,88	0
3	MG	D	602	1/1	0.60	0.28	41,41,41,41	0
6	EDO	C	608	4/4	0.63	0.25	56,67,68,73	0
6	EDO	C	613	4/4	0.63	0.24	63,70,73,73	0
7	PEG	A	615	7/7	0.63	0.36	48,63,77,78	0
7	PEG	D	615	7/7	0.67	0.26	60,74,83,86	0
8	PG4	A	616	13/13	0.67	0.19	58,75,86,90	0
6	EDO	A	608	4/4	0.69	0.27	50,55,59,63	0
6	EDO	B	611	4/4	0.71	0.16	79,79,80,81	0
6	EDO	B	614	4/4	0.77	0.27	61,69,70,74	0
6	EDO	B	616	4/4	0.77	0.21	72,75,76,77	0
3	MG	B	604	1/1	0.78	0.23	35,35,35,35	0
3	MG	A	605	1/1	0.78	0.31	69,69,69,69	0
3	MG	A	603	1/1	0.79	0.42	49,49,49,49	0
6	EDO	C	607	4/4	0.79	0.19	57,59,65,65	0
6	EDO	B	610	4/4	0.80	0.12	56,59,59,65	0
6	EDO	A	612	4/4	0.81	0.30	63,63,68,68	0
9	PGE	B	608	10/10	0.81	0.25	46,68,79,86	0
3	MG	B	605	1/1	0.83	0.12	44,44,44,44	0
6	EDO	A	613	4/4	0.84	0.22	51,51,61,63	0
6	EDO	D	611	4/4	0.84	0.13	60,64,67,73	0
3	MG	C	602	1/1	0.84	0.21	47,47,47,47	0
6	EDO	B	617	4/4	0.86	0.17	66,67,68,69	0
3	MG	A	602	1/1	0.88	0.18	34,34,34,34	0
6	EDO	D	610	4/4	0.88	0.15	57,60,61,70	0
6	EDO	A	614	4/4	0.88	0.18	53,55,57,62	0
6	EDO	D	613	4/4	0.88	0.10	53,60,65,68	0
6	EDO	C	612	4/4	0.89	0.22	65,72,72,73	0
6	EDO	B	613	4/4	0.90	0.12	42,50,54,62	0
6	EDO	B	609	4/4	0.90	0.15	59,65,68,73	0
3	MG	B	602	1/1	0.91	0.16	38,38,38,38	0
6	EDO	C	606	4/4	0.91	0.22	61,62,65,72	0
3	MG	D	603	1/1	0.92	0.15	35,35,35,35	0
6	EDO	C	610	4/4	0.92	0.25	40,41,52,53	0
6	EDO	A	610	4/4	0.92	0.17	46,48,51,51	0
6	EDO	B	615	4/4	0.92	0.19	55,64,66,67	0
6	EDO	D	608	4/4	0.92	0.11	42,42,43,46	0
6	EDO	A	611	4/4	0.92	0.14	56,57,57,58	0
6	EDO	D	612	4/4	0.93	0.17	47,51,53,61	0
6	EDO	C	611	4/4	0.93	0.24	41,52,53,64	0
6	EDO	D	607	4/4	0.94	0.17	59,61,67,72	0
6	EDO	D	614	4/4	0.94	0.12	54,60,61,67	0
6	EDO	C	605	4/4	0.95	0.12	60,60,67,68	0

Continued on next page...

Continued from previous page...

Mol	Type	Chain	Res	Atoms	RSCC	RSR	B-factors(\AA^2)	Q<0.9
6	EDO	A	609	4/4	0.95	0.14	43,44,44,44	0
5	OXL	D	606	6/6	0.96	0.09	35,38,41,43	0
6	EDO	B	612	4/4	0.96	0.13	44,56,60,64	0
6	EDO	D	609	4/4	0.96	0.16	41,46,46,48	0
5	OXL	B	607	6/6	0.97	0.10	33,36,44,45	0
5	OXL	C	604	6/6	0.97	0.09	33,42,44,50	0
3	MG	B	603	1/1	0.97	0.16	25,25,25,25	0
2	FBP	B	601	20/20	0.97	0.09	39,43,47,48	0
5	OXL	A	607	6/6	0.97	0.08	32,35,37,41	0
10	CL	D	616	1/1	0.97	0.09	62,62,62,62	0
4	ATP	A	606	31/31	0.98	0.10	27,31,34,38	0
4	ATP	B	606	31/31	0.98	0.09	25,36,43,45	0
4	ATP	D	605	31/31	0.98	0.09	30,37,43,44	0
2	FBP	C	601	20/20	0.98	0.07	32,35,39,40	0
2	FBP	D	601	20/20	0.98	0.10	37,42,45,49	0
2	FBP	A	601	20/20	0.99	0.10	29,31,34,35	0
3	MG	A	604	1/1	0.99	0.19	24,24,24,24	0
3	MG	D	604	1/1	0.99	0.16	28,28,28,28	0
3	MG	C	603	1/1	0.99	0.13	26,26,26,26	0

The following is a graphical depiction of the model fit to experimental electron density of all instances of the Ligand of Interest. In addition, ligands with molecular weight > 250 and outliers as shown on the geometry validation Tables will also be included. Each fit is shown from different orientation to approximate a three-dimensional view.

Electron density around FBP B 601:

$2mF_o-DF_c$ (at 0.7 rmsd) in gray
 mF_o-DF_c (at 3 rmsd) in purple (negative)
and green (positive)

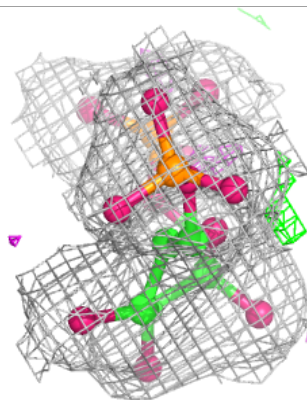
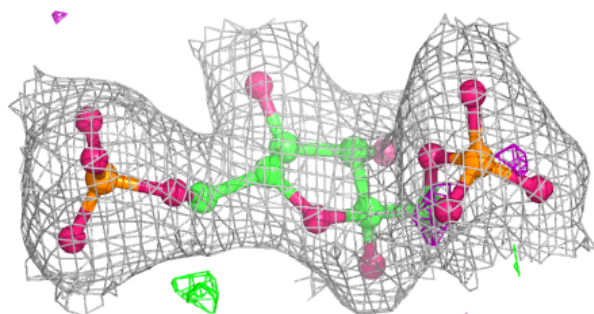
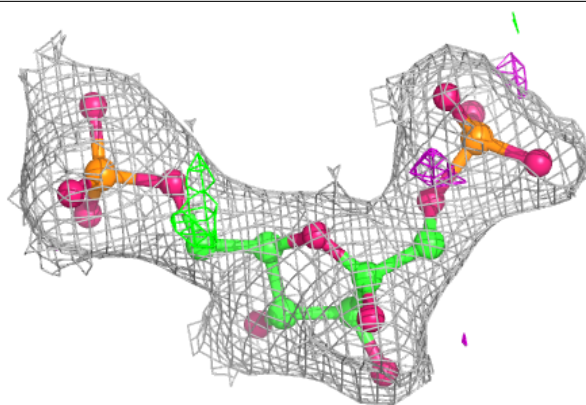
**Electron density around ATP A 606:**

$2mF_o-DF_c$ (at 0.7 rmsd) in gray
 mF_o-DF_c (at 3 rmsd) in purple (negative)
and green (positive)

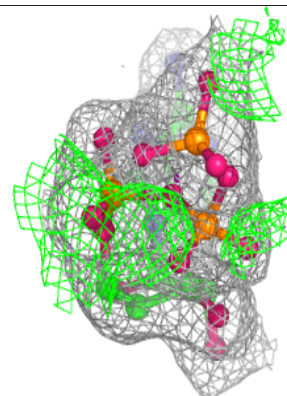
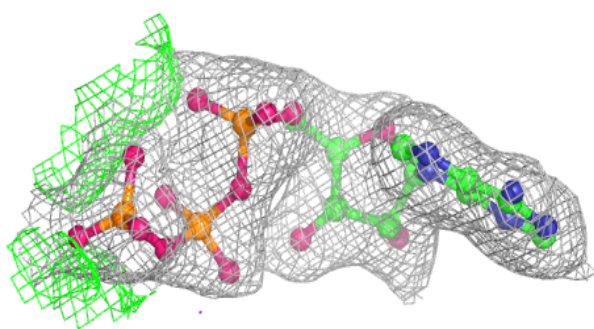
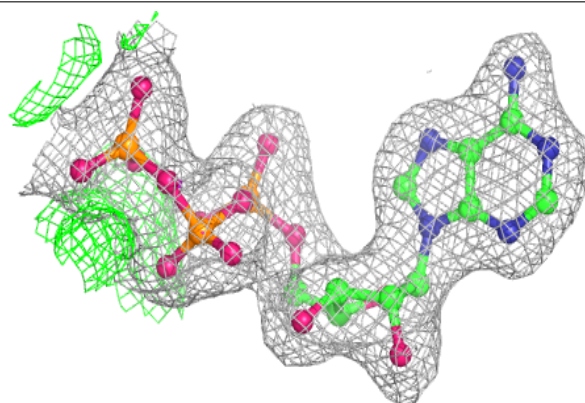

Electron density around ATP B 606:

$2mF_o-DF_c$ (at 0.7 rmsd) in gray
 mF_o-DF_c (at 3 rmsd) in purple (negative)
and green (positive)

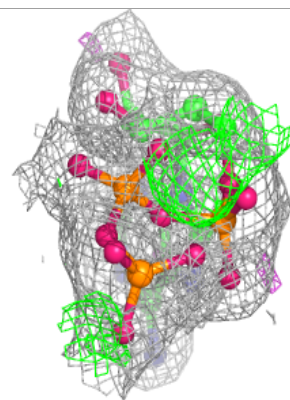
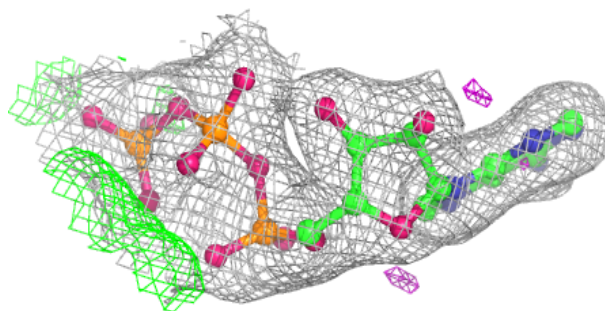
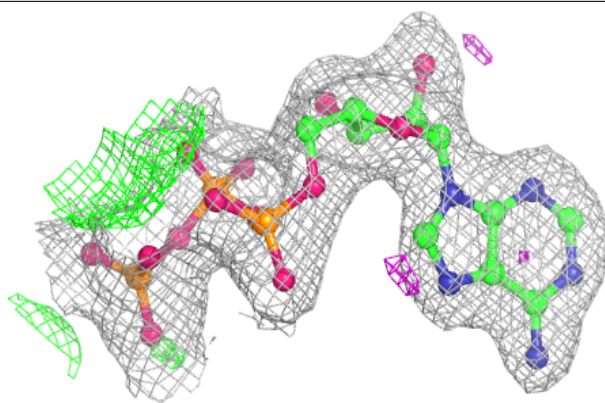
**Electron density around ATP D 605:**

$2mF_o-DF_c$ (at 0.7 rmsd) in gray
 mF_o-DF_c (at 3 rmsd) in purple (negative)
and green (positive)

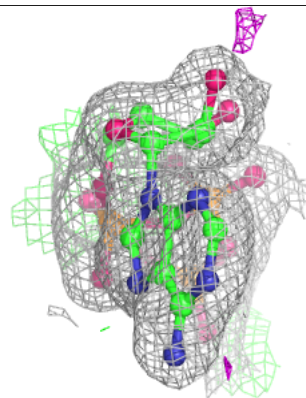
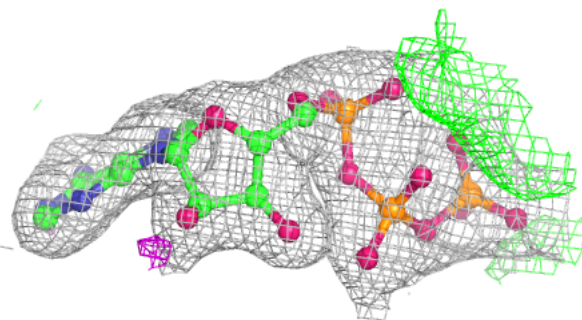
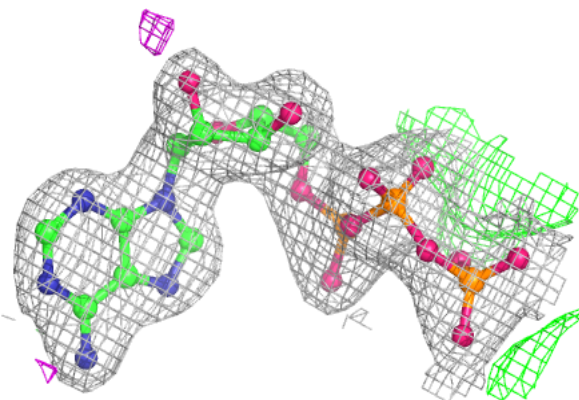

Electron density around FBP C 601:

$2mF_o-DF_c$ (at 0.7 rmsd) in gray
 mF_o-DF_c (at 3 rmsd) in purple (negative)
and green (positive)

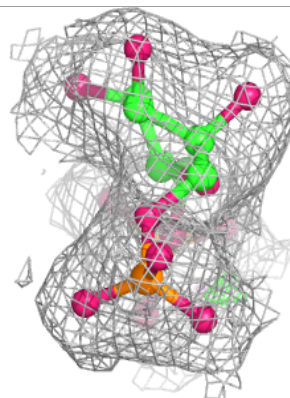
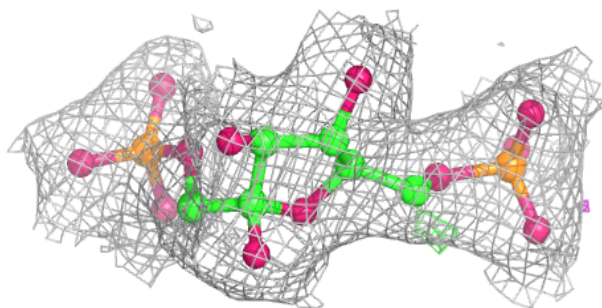
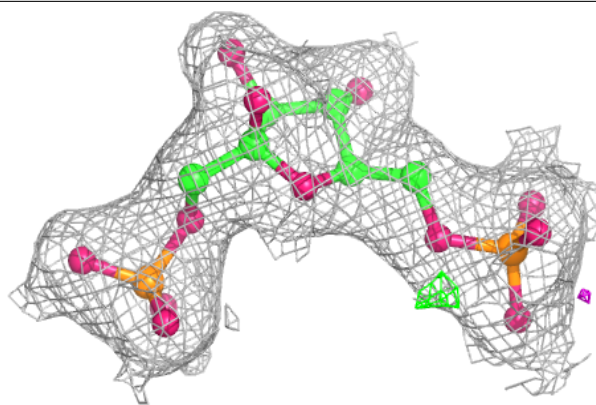
**Electron density around FBP D 601:**

$2mF_o-DF_c$ (at 0.7 rmsd) in gray
 mF_o-DF_c (at 3 rmsd) in purple (negative)
and green (positive)

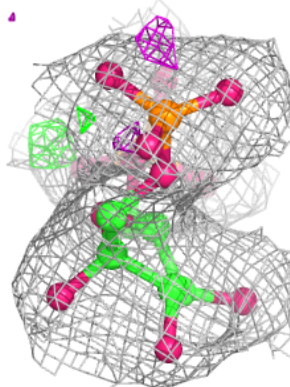
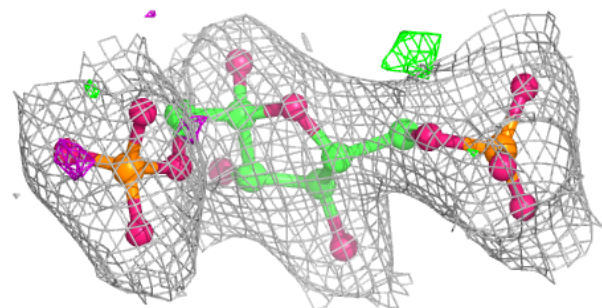
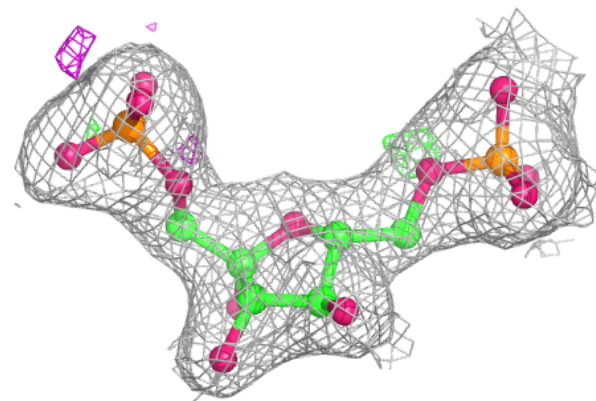

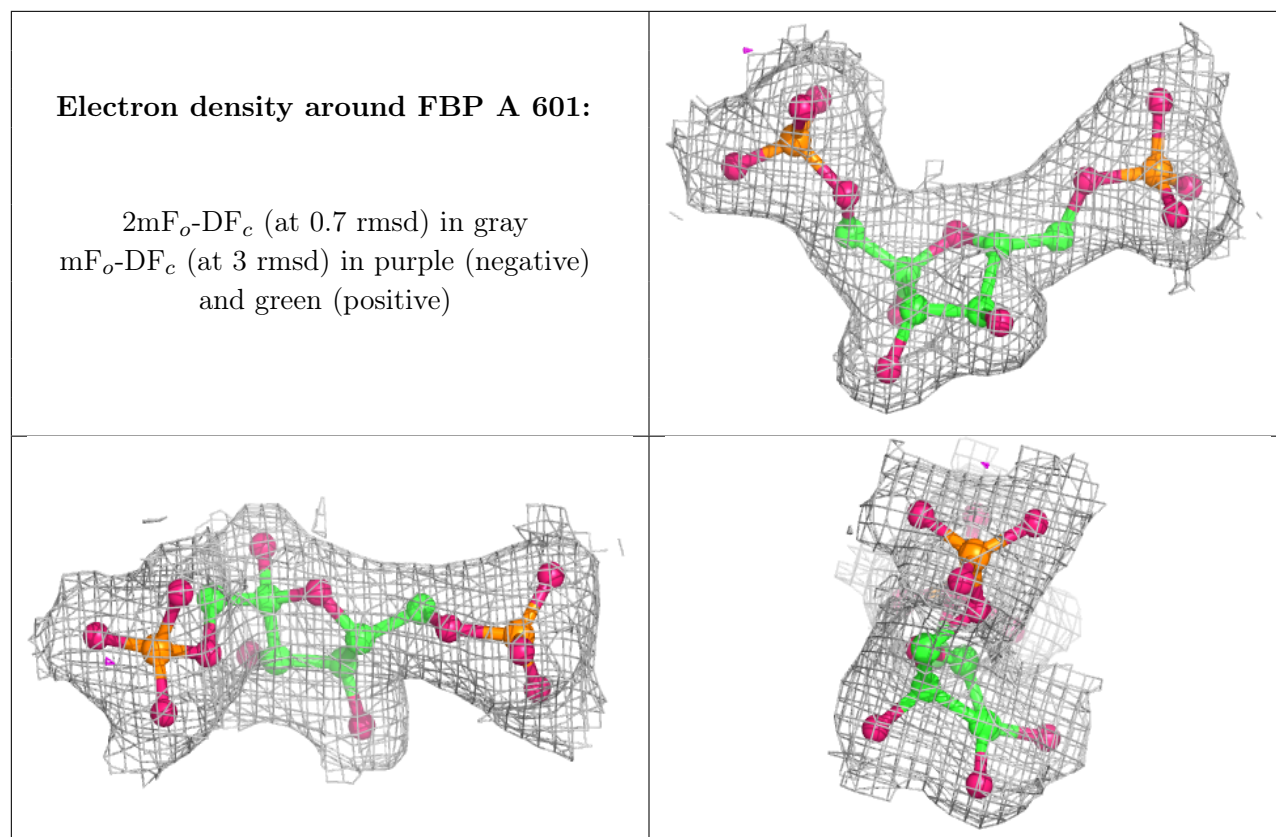

6.5 Other polymers [i](#)

There are no such residues in this entry.