



wwPDB X-ray Structure Validation Summary Report ⓘ

Sep 26, 2023 – 07:52 AM EDT

PDB ID : 6BWY
Title : DNA substrate selection by APOBEC3G
Authors : Ziegler, S.J.; Buzovetsky, O.
Deposited on : 2017-12-15
Resolution : 2.90 Å(reported)

This is a wwPDB X-ray Structure Validation Summary Report for a publicly released PDB entry.

We welcome your comments at validation@mail.wwpdb.org

A user guide is available at

<https://www.wwpdb.org/validation/2017/XrayValidationReportHelp>

with specific help available everywhere you see the ⓘ symbol.

The types of validation reports are described at

<http://www.wwpdb.org/validation/2017/FAQs#types>.

The following versions of software and data (see [references ⓘ](#)) were used in the production of this report:

MolProbity : 4.02b-467
Mogul : 1.8.5 (274361), CSD as541be (2020)
Xtriage (Phenix) : 1.13
EDS : 2.35.1
Percentile statistics : 20191225.v01 (using entries in the PDB archive December 25th 2019)
Refmac : 5.8.0158
CCP4 : 7.0.044 (Gargrove)
Ideal geometry (proteins) : Engh & Huber (2001)
Ideal geometry (DNA, RNA) : Parkinson et al. (1996)
Validation Pipeline (wwPDB-VP) : 2.35.1

1 Overall quality at a glance

The following experimental techniques were used to determine the structure:

X-RAY DIFFRACTION

The reported resolution of this entry is 2.90 Å.

Percentile scores (ranging between 0-100) for global validation metrics of the entry are shown in the following graphic. The table shows the number of entries on which the scores are based.

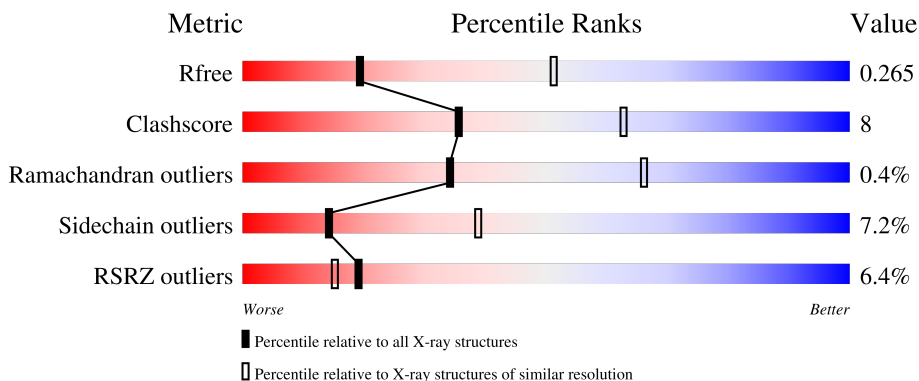

Metric	Whole archive (#Entries)	Similar resolution (#Entries, resolution range(Å))
R_{free}	130704	1957 (2.90-2.90)
Clashscore	141614	2172 (2.90-2.90)
Ramachandran outliers	138981	2115 (2.90-2.90)
Sidechain outliers	138945	2117 (2.90-2.90)
RSRZ outliers	127900	1906 (2.90-2.90)

The table below summarises the geometric issues observed across the polymeric chains and their fit to the electron density. The red, orange, yellow and green segments of the lower bar indicate the fraction of residues that contain outliers for ≥ 3 , 2, 1 and 0 types of geometric quality criteria respectively. A grey segment represents the fraction of residues that are not modelled. The numeric value for each fraction is indicated below the corresponding segment, with a dot representing fractions $\leq 5\%$. The upper red bar (where present) indicates the fraction of residues that have poor fit to the electron density. The numeric value is given above the bar.

Mol	Chain	Length	Quality of chain
1	C	30	17% 77%
1	D	30	20% 77%
1	F	30	17% 7% 77%
1	I	30	7% 13% 77%
2	A	361	9% 70% 23% 5%

Continued on next page...

Continued from previous page...

Mol	Chain	Length	Quality of chain
2	B	361	<p>3% 73% 19% . .</p>
2	E	361	<p>7% 74% 19% . .</p>
2	G	361	<p>6% 73% 21% . .</p>

The following table lists non-polymeric compounds, carbohydrate monomers and non-standard residues in protein, DNA, RNA chains that are outliers for geometric or electron-density-fit criteria:

Mol	Type	Chain	Res	Chirality	Geometry	Clashes	Electron density
3	PO4	E	403	-	-	X	-

2 Entry composition [i](#)

There are 5 unique types of molecules in this entry. The entry contains 11882 atoms, of which 0 are hydrogens and 0 are deuteriums.

In the tables below, the ZeroOcc column contains the number of atoms modelled with zero occupancy, the AltConf column contains the number of residues with at least one atom in alternate conformation and the Trace column contains the number of residues modelled with at most 2 atoms.

- Molecule 1 is a DNA chain called DNA (30-MER).

Mol	Chain	Residues	Atoms					ZeroOcc	AltConf	Trace
			Total	C	N	O	P			
1	I	7	Total 145	C 69	N 27	O 42	P 7	0	0	0
1	C	7	Total 142	C 69	N 27	O 40	P 6	0	0	0
1	D	7	Total 145	C 69	N 27	O 42	P 7	0	0	0
1	F	7	Total 145	C 69	N 27	O 42	P 7	0	0	0

- Molecule 2 is a protein called Protection of telomeres protein 1, DNA dC->dU-editing enzyme APOBEC-3G fusion.

Mol	Chain	Residues	Atoms					ZeroOcc	AltConf	Trace
			Total	C	N	O	S			
2	A	344	Total 2781	C 1766	N 484	O 516	S 15	0	0	0
2	B	346	Total 2794	C 1773	N 486	O 520	S 15	0	0	0
2	E	346	Total 2794	C 1773	N 486	O 520	S 15	0	0	0
2	G	346	Total 2800	C 1776	N 489	O 520	S 15	0	0	0

There are 24 discrepancies between the modelled and reference sequences:

Chain	Residue	Modelled	Actual	Comment	Reference
A	24	MET	-	initiating methionine	UNP O13988
A	234	LYS	LEU	engineered mutation	UNP Q9HC16
A	243	ALA	CYS	engineered mutation	UNP Q9HC16
A	310	LYS	PHE	engineered mutation	UNP Q9HC16
A	321	ALA	CYS	engineered mutation	UNP Q9HC16
A	356	ALA	CYS	engineered mutation	UNP Q9HC16
B	24	MET	-	initiating methionine	UNP O13988

Continued on next page...

Continued from previous page...

Chain	Residue	Modelled	Actual	Comment	Reference
B	234	LYS	LEU	engineered mutation	UNP Q9HC16
B	243	ALA	CYS	engineered mutation	UNP Q9HC16
B	310	LYS	PHE	engineered mutation	UNP Q9HC16
B	321	ALA	CYS	engineered mutation	UNP Q9HC16
B	356	ALA	CYS	engineered mutation	UNP Q9HC16
E	24	MET	-	initiating methionine	UNP O13988
E	234	LYS	LEU	engineered mutation	UNP Q9HC16
E	243	ALA	CYS	engineered mutation	UNP Q9HC16
E	310	LYS	PHE	engineered mutation	UNP Q9HC16
E	321	ALA	CYS	engineered mutation	UNP Q9HC16
E	356	ALA	CYS	engineered mutation	UNP Q9HC16
G	24	MET	-	initiating methionine	UNP O13988
G	234	LYS	LEU	engineered mutation	UNP Q9HC16
G	243	ALA	CYS	engineered mutation	UNP Q9HC16
G	310	LYS	PHE	engineered mutation	UNP Q9HC16
G	321	ALA	CYS	engineered mutation	UNP Q9HC16
G	356	ALA	CYS	engineered mutation	UNP Q9HC16

- Molecule 3 is PHOSPHATE ION (three-letter code: PO4) (formula: O₄P).

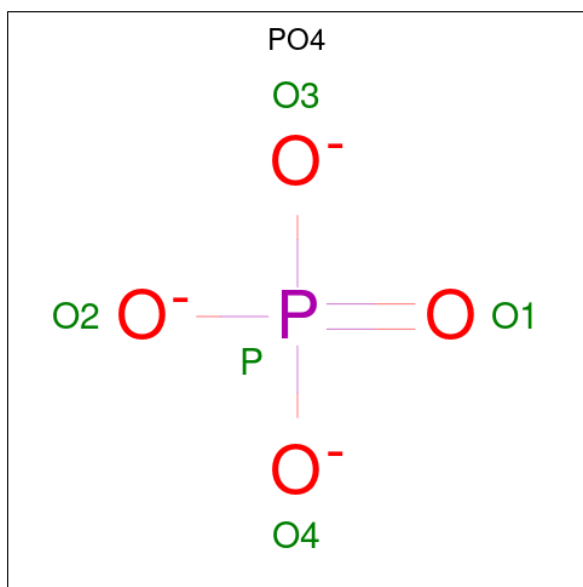

Mol	Chain	Residues	Atoms			ZeroOcc	AltConf
3	I	1	Total	O	P	0	0
			5	4	1		
3	C	1	Total	O	P	0	0
			5	4	1		
3	D	1	Total	O	P	0	0
			5	4	1		

Continued on next page...

Continued from previous page...

Mol	Chain	Residues	Atoms	ZeroOcc	AltConf
3	F	1	Total O P 5 4 1	0	0
3	A	1	Total O P 5 4 1	0	0
3	A	1	Total O P 5 4 1	0	0
3	A	1	Total O P 5 4 1	0	0
3	B	1	Total O P 5 4 1	0	0
3	B	1	Total O P 5 4 1	0	0
3	E	1	Total O P 5 4 1	0	0
3	E	1	Total O P 5 4 1	0	0
3	E	1	Total O P 5 4 1	0	0
3	G	1	Total O P 5 4 1	0	0
3	G	1	Total O P 5 4 1	0	0
3	G	1	Total O P 5 4 1	0	0

- Molecule 4 is ZINC ION (three-letter code: ZN) (formula: Zn).

Mol	Chain	Residues	Atoms	ZeroOcc	AltConf
4	A	1	Total Zn 1 1	0	0
4	B	1	Total Zn 1 1	0	0
4	E	1	Total Zn 1 1	0	0
4	G	1	Total Zn 1 1	0	0

- Molecule 5 is water.

Mol	Chain	Residues	Atoms	ZeroOcc	AltConf
5	I	1	Total O 1 1	0	0

Continued on next page...

Continued from previous page...

Mol	Chain	Residues	Atoms	ZeroOcc	AltConf
5	C	1	Total O 1 1	0	0
5	D	1	Total O 1 1	0	0
5	A	11	Total O 11 11	0	0
5	B	13	Total O 13 13	0	0
5	E	14	Total O 14 14	0	0
5	G	16	Total O 16 16	0	0

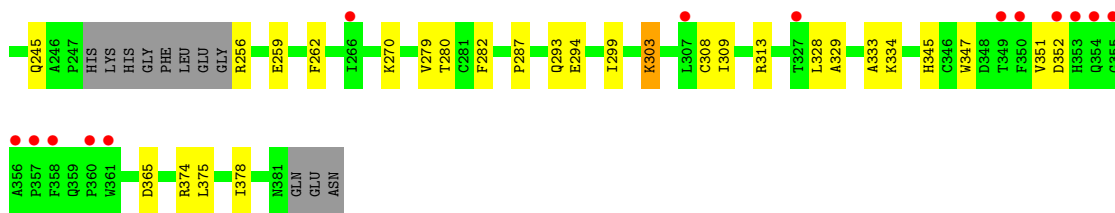

- Molecule 2: Protection of telomeres protein 1, DNA dC->dU-editing enzyme APOBEC-3G fusion

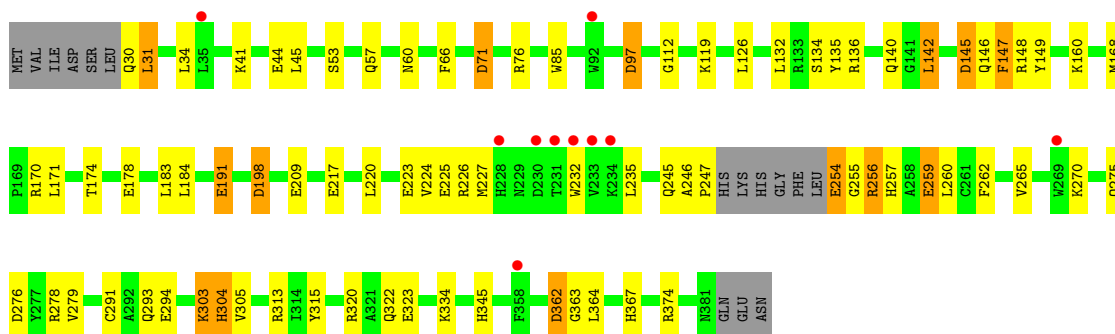
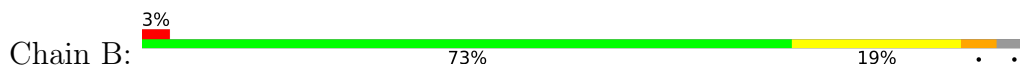

- Molecule 2: Protection of telomeres protein 1, DNA dC->dU-editing enzyme APOBEC-3G fusion

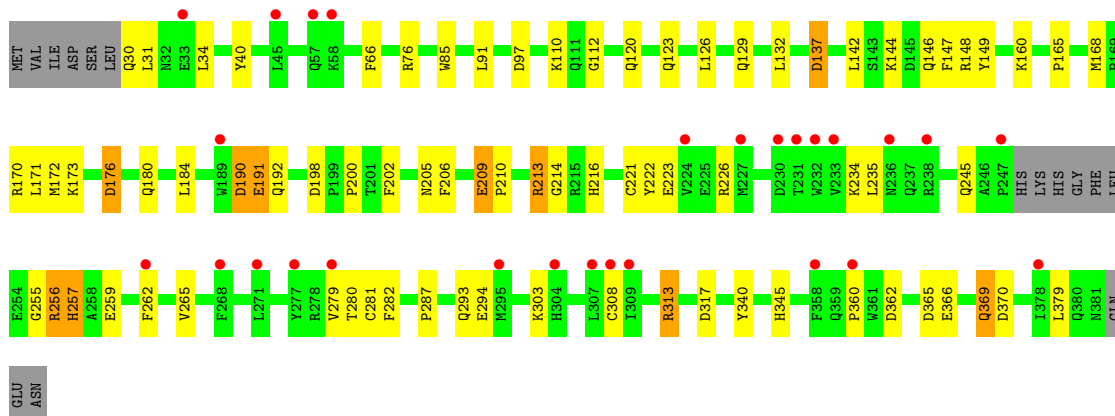
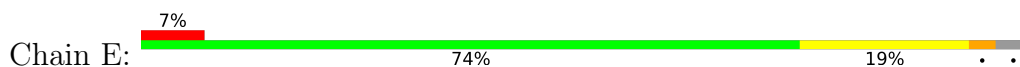

- Molecule 2: Protection of telomeres protein 1, DNA dC->dU-editing enzyme APOBEC-3G fusion

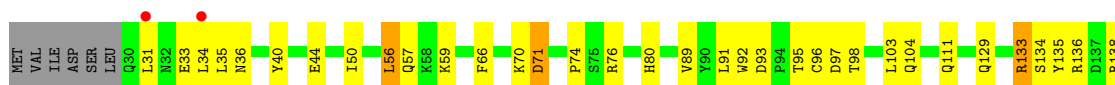
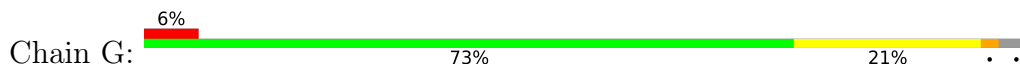

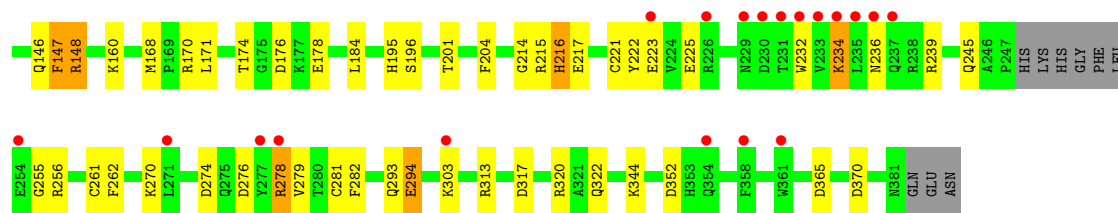

4 Data and refinement statistics i

Property	Value	Source
Space group	P 43	Depositor
Cell constants a, b, c, α , β , γ	79.07Å 79.07Å 266.41Å 90.00° 90.00° 90.00°	Depositor
Resolution (Å)	44.19 – 2.90 44.19 – 2.90	Depositor EDS
% Data completeness (in resolution range)	96.2 (44.19-2.90) 99.3 (44.19-2.90)	Depositor EDS
R_{merge}	0.10	Depositor
R_{sym}	(Not available)	Depositor
$\langle I/\sigma(I) \rangle$ ¹	1.98 (at 2.90Å)	Xtrriage
Refinement program	REFMAC 5.8.0103	Depositor
R, R_{free}	0.234 , 0.287 0.221 , 0.265	Depositor DCC
R_{free} test set	1786 reflections (4.99%)	wwPDB-VP
Wilson B-factor (Å ²)	72.8	Xtrriage
Anisotropy	0.336	Xtrriage
Bulk solvent k_{sol} (e/Å ³), B_{sol} (Å ²)	0.34 , 58.5	EDS
L-test for twinning ²	$\langle L \rangle = 0.52$, $\langle L^2 \rangle = 0.35$	Xtrriage
Estimated twinning fraction	0.186 for h,-k,-l	Xtrriage
Reported twinning fraction	0.501 for H, K, L 0.499 for -H, K, -L	Depositor
Outliers	1 of 35772 reflections (0.003%)	Xtrriage
F_o, F_c correlation	0.94	EDS
Total number of atoms	11882	wwPDB-VP
Average B, all atoms (Å ²)	89.0	wwPDB-VP

Xtrriage's analysis on translational NCS is as follows: *The analyses of the Patterson function reveals a significant off-origin peak that is 40.88 % of the origin peak, indicating pseudo-translational symmetry. The chance of finding a peak of this or larger height randomly in a structure without pseudo-translational symmetry is equal to 2.5639e-04. The detected translational NCS is most likely also responsible for the elevated intensity ratio.*

¹Intensities estimated from amplitudes.

²Theoretical values of $\langle |L| \rangle$, $\langle L^2 \rangle$ for acentric reflections are 0.5, 0.333 respectively for untwinned datasets, and 0.375, 0.2 for perfectly twinned datasets.

5 Model quality [i](#)

5.1 Standard geometry [i](#)

Bond lengths and bond angles in the following residue types are not validated in this section: ZN, PO4

The Z score for a bond length (or angle) is the number of standard deviations the observed value is removed from the expected value. A bond length (or angle) with $|Z| > 5$ is considered an outlier worth inspection. RMSZ is the root-mean-square of all Z scores of the bond lengths (or angles).

Mol	Chain	Bond lengths		Bond angles	
		RMSZ	# Z >5	RMSZ	# Z >5
1	C	0.92	0/159	1.37	4/244 (1.6%)
1	D	1.23	1/162 (0.6%)	1.67	2/248 (0.8%)
1	F	0.91	0/162	1.49	2/248 (0.8%)
1	I	1.14	1/162 (0.6%)	1.45	4/248 (1.6%)
2	A	0.95	1/2854 (0.0%)	1.00	12/3873 (0.3%)
2	B	1.05	4/2867 (0.1%)	1.05	16/3890 (0.4%)
2	E	0.96	1/2867 (0.0%)	1.00	8/3890 (0.2%)
2	G	0.99	5/2873 (0.2%)	1.03	13/3897 (0.3%)
All	All	0.99	13/12106 (0.1%)	1.05	61/16538 (0.4%)

Chiral center outliers are detected by calculating the chiral volume of a chiral center and verifying if the center is modelled as a planar moiety or with the opposite hand. A planarity outlier is detected by checking planarity of atoms in a peptide group, atoms in a mainchain group or atoms of a sidechain that are expected to be planar.

Mol	Chain	#Chirality outliers	#Planarity outliers
2	G	0	1

The worst 5 of 13 bond length outliers are listed below:

Mol	Chain	Res	Type	Atoms	Z	Observed(Å)	Ideal(Å)
2	E	313	ARG	CZ-NH1	6.54	1.41	1.33
2	A	137	ASP	CB-CG	6.40	1.65	1.51
2	G	313	ARG	CZ-NH1	6.35	1.41	1.33
1	I	6	DA	O3'-P	-6.03	1.53	1.61
1	D	4	DT	O3'-P	-5.91	1.54	1.61

The worst 5 of 61 bond angle outliers are listed below:

Mol	Chain	Res	Type	Atoms	Z	Observed(°)	Ideal(°)
1	F	4	DT	O5'-P-OP2	-13.66	93.41	105.70
1	D	1	DA	O5'-P-OP1	13.09	126.40	110.70
2	G	133	ARG	NE-CZ-NH2	10.17	125.39	120.30
2	A	89	VAL	CG1-CB-CG2	-8.79	96.83	110.90
2	E	213	ARG	NE-CZ-NH2	-7.93	116.33	120.30

There are no chirality outliers.

All (1) planarity outliers are listed below:

Mol	Chain	Res	Type	Group
2	G	56	LEU	Peptide

5.2 Too-close contacts [i](#)

In the following table, the Non-H and H(model) columns list the number of non-hydrogen atoms and hydrogen atoms in the chain respectively. The H(added) column lists the number of hydrogen atoms added and optimized by MolProbity. The Clashes column lists the number of clashes within the asymmetric unit, whereas Symm-Clashes lists symmetry-related clashes.

Mol	Chain	Non-H	H(model)	H(added)	Clashes	Symm-Clashes
1	C	142	0	81	7	0
1	D	145	0	80	5	1
1	F	145	0	80	1	0
1	I	145	0	80	17	0
2	A	2781	0	2654	60	1
2	B	2794	0	2665	58	1
2	E	2794	0	2664	32	1
2	G	2800	0	2674	41	2
3	A	15	0	0	0	0
3	B	10	0	0	0	0
3	C	5	0	0	0	0
3	D	5	0	0	0	0
3	E	15	0	0	2	0
3	F	5	0	0	1	0
3	G	15	0	0	1	0
3	I	5	0	0	0	0
4	A	1	0	0	0	0
4	B	1	0	0	1	0
4	E	1	0	0	0	0
4	G	1	0	0	0	0
5	A	11	0	0	2	0
5	B	13	0	0	3	0

Continued on next page...

Continued from previous page...

Mol	Chain	Non-H	H(model)	H(added)	Clashes	Symm-Clashes
5	C	1	0	0	0	0
5	D	1	0	0	0	0
5	E	14	0	0	1	0
5	G	16	0	0	1	0
5	I	1	0	0	0	0
All	All	11882	0	10978	184	3

The all-atom clashscore is defined as the number of clashes found per 1000 atoms (including hydrogen atoms). The all-atom clashscore for this structure is 8.

The worst 5 of 184 close contacts within the same asymmetric unit are listed below, sorted by their clash magnitude.

Atom-1	Atom-2	Interatomic distance (Å)	Clash overlap (Å)
2:A:329:ALA:HB1	2:B:303:LYS:HG3	1.22	1.17
2:A:329:ALA:HB1	2:B:303:LYS:CG	1.80	1.08
2:A:329:ALA:O	2:B:303:LYS:HD3	1.54	1.06
2:B:320:ARG:NH2	2:G:71:ASP:OD2	2.03	0.91
5:A:502:HOH:O	2:B:278:ARG:HD3	1.76	0.85

All (3) symmetry-related close contacts are listed below. The label for Atom-2 includes the symmetry operator and encoded unit-cell translations to be applied.

Atom-1	Atom-2	Interatomic distance (Å)	Clash overlap (Å)
2:A:100:SER:OG	2:E:137:ASP:OD2[3_844]	2.01	0.19
1:D:4:DT:OP1	2:G:136:ARG:NH1[4_575]	2.15	0.05
2:B:71:ASP:OD2	2:G:320:ARG:NH2[1_545]	2.19	0.01

5.3 Torsion angles [i](#)

5.3.1 Protein backbone [i](#)

In the following table, the Percentiles column shows the percent Ramachandran outliers of the chain as a percentile score with respect to all X-ray entries followed by that with respect to entries of similar resolution.

The Analysed column shows the number of residues for which the backbone conformation was analysed, and the total number of residues.

Mol	Chain	Analysed	Favoured	Allowed	Outliers	Percentiles	
2	A	340/361 (94%)	324 (95%)	15 (4%)	1 (0%)	41	71
2	B	342/361 (95%)	322 (94%)	19 (6%)	1 (0%)	41	71
2	E	342/361 (95%)	322 (94%)	19 (6%)	1 (0%)	41	71
2	G	342/361 (95%)	321 (94%)	19 (6%)	2 (1%)	25	58
All	All	1366/1444 (95%)	1289 (94%)	72 (5%)	5 (0%)	34	66

All (5) Ramachandran outliers are listed below:

Mol	Chain	Res	Type
2	B	245	GLN
2	A	216	HIS
2	G	216	HIS
2	E	216	HIS
2	G	74	PRO

5.3.2 Protein sidechains [i](#)

In the following table, the Percentiles column shows the percent sidechain outliers of the chain as a percentile score with respect to all X-ray entries followed by that with respect to entries of similar resolution.

The Analysed column shows the number of residues for which the sidechain conformation was analysed, and the total number of residues.

Mol	Chain	Analysed	Rotameric	Outliers	Percentiles	
2	A	302/327 (92%)	283 (94%)	19 (6%)	18	46
2	B	303/327 (93%)	281 (93%)	22 (7%)	14	38
2	E	303/327 (93%)	277 (91%)	26 (9%)	10	30
2	G	304/327 (93%)	284 (93%)	20 (7%)	16	44
All	All	1212/1308 (93%)	1125 (93%)	87 (7%)	14	39

5 of 87 residues with a non-rotameric sidechain are listed below:

Mol	Chain	Res	Type
2	E	234	LYS
2	G	66	PHE
2	E	257	HIS
2	E	369	GLN
2	G	146	GLN

Sometimes sidechains can be flipped to improve hydrogen bonding and reduce clashes. All (4) such sidechains are listed below:

Mol	Chain	Res	Type
2	E	129	GLN
2	E	245	GLN
2	G	129	GLN
2	G	216	HIS

5.3.3 RNA [i](#)

There are no RNA molecules in this entry.

5.4 Non-standard residues in protein, DNA, RNA chains [i](#)

There are no non-standard protein/DNA/RNA residues in this entry.

5.5 Carbohydrates [i](#)

There are no monosaccharides in this entry.

5.6 Ligand geometry [i](#)

Of 19 ligands modelled in this entry, 4 are monoatomic - leaving 15 for Mogul analysis.

In the following table, the Counts columns list the number of bonds (or angles) for which Mogul statistics could be retrieved, the number of bonds (or angles) that are observed in the model and the number of bonds (or angles) that are defined in the Chemical Component Dictionary. The Link column lists molecule types, if any, to which the group is linked. The Z score for a bond length (or angle) is the number of standard deviations the observed value is removed from the expected value. A bond length (or angle) with $|Z| > 2$ is considered an outlier worth inspection. RMSZ is the root-mean-square of all Z scores of the bond lengths (or angles).

Mol	Type	Chain	Res	Link	Bond lengths			Bond angles		
					Counts	RMSZ	$\# Z > 2$	Counts	RMSZ	$\# Z > 2$
3	PO4	B	402	-	4,4,4	0.82	0	6,6,6	0.98	0
3	PO4	G	402	-	4,4,4	0.92	0	6,6,6	0.55	0
3	PO4	E	403	-	4,4,4	1.18	0	6,6,6	1.36	2 (33%)
3	PO4	E	404	-	4,4,4	0.62	0	6,6,6	0.89	0
3	PO4	E	402	-	4,4,4	0.78	0	6,6,6	1.10	1 (16%)
3	PO4	G	404	-	4,4,4	0.63	0	6,6,6	1.34	1 (16%)
3	PO4	A	402	-	4,4,4	0.77	0	6,6,6	0.86	0

Mol	Type	Chain	Res	Link	Bond lengths			Bond angles		
					Counts	RMSZ	# Z > 2	Counts	RMSZ	# Z > 2
3	PO4	I	101	-	4,4,4	0.70	0	6,6,6	1.02	0
3	PO4	B	403	-	4,4,4	0.91	0	6,6,6	0.64	0
3	PO4	F	101	-	4,4,4	0.76	0	6,6,6	0.81	0
3	PO4	G	403	-	4,4,4	0.80	0	6,6,6	0.81	0
3	PO4	A	403	-	4,4,4	0.88	0	6,6,6	0.72	0
3	PO4	C	101	-	4,4,4	1.05	0	6,6,6	0.67	0
3	PO4	A	404	-	4,4,4	0.88	0	6,6,6	0.71	0
3	PO4	D	101	-	4,4,4	0.78	0	6,6,6	1.07	0

There are no bond length outliers.

All (4) bond angle outliers are listed below:

Mol	Chain	Res	Type	Atoms	Z	Observed(°)	Ideal(°)
3	E	402	PO4	O3-P-O1	-2.12	103.14	110.89
3	G	404	PO4	O3-P-O1	-2.11	103.17	110.89
3	E	403	PO4	O4-P-O2	2.08	114.63	107.97
3	E	403	PO4	O2-P-O1	-2.01	103.53	110.89

There are no chirality outliers.

There are no torsion outliers.

There are no ring outliers.

3 monomers are involved in 4 short contacts:

Mol	Chain	Res	Type	Clashes	Symm-Clashes
3	E	403	PO4	2	0
3	F	101	PO4	1	0
3	G	403	PO4	1	0

5.7 Other polymers [i](#)

There are no such residues in this entry.

5.8 Polymer linkage issues [i](#)

There are no chain breaks in this entry.

6 Fit of model and data [i](#)

6.1 Protein, DNA and RNA chains [i](#)

In the following table, the column labelled ‘#RSRZ > 2’ contains the number (and percentage) of RSRZ outliers, followed by percent RSRZ outliers for the chain as percentile scores relative to all X-ray entries and entries of similar resolution. The OWAB column contains the minimum, median, 95th percentile and maximum values of the occupancy-weighted average B-factor per residue. The column labelled ‘Q < 0.9’ lists the number of (and percentage) of residues with an average occupancy less than 0.9.

Mol	Chain	Analysed	<RSRZ>	#RSRZ>2	OWAB(Å ²)	Q<0.9
1	C	7/30 (23%)	-0.07	0 100 100	59, 64, 70, 77	0
1	D	7/30 (23%)	-0.20	0 100 100	53, 57, 62, 73	0
1	F	7/30 (23%)	-0.31	0 100 100	59, 64, 72, 77	0
1	I	7/30 (23%)	-0.37	0 100 100	57, 63, 69, 76	0
2	A	344/361 (95%)	0.47	32 (9%) 8 6	47, 90, 154, 190	0
2	B	346/361 (95%)	0.19	10 (2%) 51 47	40, 79, 128, 222	0
2	E	346/361 (95%)	0.42	27 (7%) 13 10	49, 92, 140, 247	0
2	G	346/361 (95%)	0.36	21 (6%) 21 17	49, 83, 140, 200	0
All	All	1410/1564 (90%)	0.35	90 (6%) 19 15	40, 85, 141, 247	0

The worst 5 of 90 RSRZ outliers are listed below:

Mol	Chain	Res	Type	RSRZ
2	E	232	TRP	20.2
2	B	232	TRP	10.8
2	B	233	VAL	10.4
2	G	232	TRP	7.2
2	A	361	TRP	7.1

6.2 Non-standard residues in protein, DNA, RNA chains [i](#)

There are no non-standard protein/DNA/RNA residues in this entry.

6.3 Carbohydrates [i](#)

There are no monosaccharides in this entry.

6.4 Ligands [i](#)

In the following table, the Atoms column lists the number of modelled atoms in the group and the number defined in the chemical component dictionary. The B-factors column lists the minimum, median, 95th percentile and maximum values of B factors of atoms in the group. The column labelled 'Q< 0.9' lists the number of atoms with occupancy less than 0.9.

Mol	Type	Chain	Res	Atoms	RSCC	RSR	B-factors(Å ²)	Q<0.9
3	PO4	A	404	5/5	0.82	0.19	104,112,128,138	0
3	PO4	G	403	5/5	0.88	0.20	83,85,98,107	0
3	PO4	A	403	5/5	0.90	0.25	82,88,100,103	0
3	PO4	E	404	5/5	0.92	0.18	99,102,122,122	0
3	PO4	I	101	5/5	0.92	0.19	92,99,102,104	0
3	PO4	D	101	5/5	0.93	0.22	70,82,84,100	0
3	PO4	G	404	5/5	0.93	0.18	81,81,95,97	0
3	PO4	E	402	5/5	0.94	0.18	83,91,103,107	0
3	PO4	B	402	5/5	0.94	0.15	84,86,92,95	0
3	PO4	F	101	5/5	0.95	0.16	81,92,104,107	0
3	PO4	B	403	5/5	0.95	0.17	72,87,94,95	0
3	PO4	A	402	5/5	0.95	0.22	78,87,91,101	0
4	ZN	A	401	1/1	0.95	0.16	126,126,126,126	0
3	PO4	C	101	5/5	0.96	0.20	71,84,87,97	0
3	PO4	E	403	5/5	0.96	0.16	70,71,83,84	0
3	PO4	G	402	5/5	0.97	0.19	67,80,90,91	0
4	ZN	G	401	1/1	0.97	0.20	104,104,104,104	0
4	ZN	E	401	1/1	0.98	0.19	102,102,102,102	0
4	ZN	B	401	1/1	0.99	0.26	72,72,72,72	0

6.5 Other polymers [i](#)

There are no such residues in this entry.