



Full wwPDB X-ray Structure Validation Report ⓘ

Feb 28, 2024 – 07:48 PM EST

PDB ID : 5S4P
Title : Tubulin-Z275165822-complex
Authors : Muehlethaler, T.; Gioia, D.; Prota, A.E.; Sharpe, M.E.; Cavalli, A.; Steinmetz, M.O.
Deposited on : 2020-11-08
Resolution : 2.29 Å(reported)

This is a Full wwPDB X-ray Structure Validation Report for a publicly released PDB entry.

We welcome your comments at validation@mail.wwpdb.org

A user guide is available at

<https://www.wwpdb.org/validation/2017/XrayValidationReportHelp>

with specific help available everywhere you see the ⓘ symbol.

The types of validation reports are described at

<http://www.wwpdb.org/validation/2017/FAQs#types>.

The following versions of software and data (see [references ⓘ](#)) were used in the production of this report:

MolProbity : 4.02b-467
Mogul : 1.8.5 (274361), CSD as541be (2020)
Xtriage (Phenix) : 1.13
EDS : 2.36
buster-report : 1.1.7 (2018)
Percentile statistics : 20191225.v01 (using entries in the PDB archive December 25th 2019)
Refmac : 5.8.0158
CCP4 : 7.0.044 (Gargrove)
Ideal geometry (proteins) : Engh & Huber (2001)
Ideal geometry (DNA, RNA) : Parkinson et al. (1996)
Validation Pipeline (wwPDB-VP) : 2.36

1 Overall quality at a glance i

The following experimental techniques were used to determine the structure:

X-RAY DIFFRACTION

The reported resolution of this entry is 2.29 Å.

Percentile scores (ranging between 0-100) for global validation metrics of the entry are shown in the following graphic. The table shows the number of entries on which the scores are based.

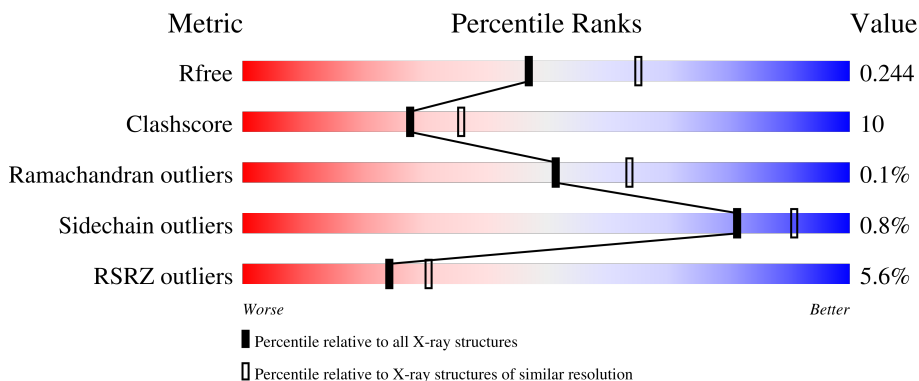

Metric	Whole archive (#Entries)	Similar resolution (#Entries, resolution range(Å))
R_{free}	130704	5042 (2.30-2.30)
Clashscore	141614	5643 (2.30-2.30)
Ramachandran outliers	138981	5575 (2.30-2.30)
Sidechain outliers	138945	5575 (2.30-2.30)
RSRZ outliers	127900	4938 (2.30-2.30)

The table below summarises the geometric issues observed across the polymeric chains and their fit to the electron density. The red, orange, yellow and green segments of the lower bar indicate the fraction of residues that contain outliers for ≥ 3 , 2, 1 and 0 types of geometric quality criteria respectively. A grey segment represents the fraction of residues that are not modelled. The numeric value for each fraction is indicated below the corresponding segment, with a dot representing fractions $\leq 5\%$. The upper red bar (where present) indicates the fraction of residues that have poor fit to the electron density. The numeric value is given above the bar.

Mol	Chain	Length	Quality of chain
1	A	451	 3% 76% 20%
1	C	451	 % 77% 20%
2	B	445	 4% 71% 24% 5%
2	D	445	 4% 75% 21%
3	E	143	 6% 78% 8% 14%

Continued on next page...

Continued from previous page...

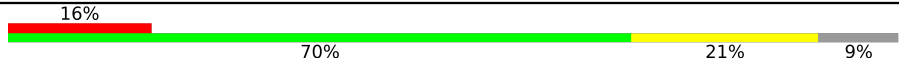
Mol	Chain	Length	Quality of chain
4	F	384	 <p>A horizontal bar chart representing the quality of chain. The bar is divided into four segments: a red segment on the left labeled '16%', a large green segment labeled '70%', a yellow segment labeled '21%', and a small grey segment on the far right labeled '9%'.</p>

2 Entry composition i

There are 12 unique types of molecules in this entry. The entry contains 18111 atoms, of which 75 are hydrogens and 0 are deuteriums.

In the tables below, the ZeroOcc column contains the number of atoms modelled with zero occupancy, the AltConf column contains the number of residues with at least one atom in alternate conformation and the Trace column contains the number of residues modelled with at most 2 atoms.

- Molecule 1 is a protein called Tubulin alpha-1B chain.

Mol	Chain	Residues	Atoms					ZeroOcc	AltConf	Trace
			Total	C	N	O	S			
1	A	438	Total	C	N	O	S	0	0	0
			3424	2167	582	653	22			
1	C	440	Total	C	N	O	S	0	2	0
			3452	2183	586	660	23			

- Molecule 2 is a protein called Tubulin beta-2B chain.

Mol	Chain	Residues	Atoms					ZeroOcc	AltConf	Trace
			Total	C	N	O	S			
2	B	422	Total	C	N	O	S	3	0	0
			3324	2090	567	640	27			
2	D	426	Total	C	N	O	S	5	0	0
			3343	2098	570	648	27			

- Molecule 3 is a protein called Stathmin-4.

Mol	Chain	Residues	Atoms					ZeroOcc	AltConf	Trace
			Total	C	N	O	S			
3	E	123	Total	C	N	O	S	0	0	0
			1014	625	183	201	5			

There are 2 discrepancies between the modelled and reference sequences:

Chain	Residue	Modelled	Actual	Comment	Reference
E	3	MET	-	initiating methionine	UNP P63043
E	4	ALA	-	expression tag	UNP P63043

- Molecule 4 is a protein called Tubulin-Tyrosine Ligase.

Mol	Chain	Residues	Atoms					ZeroOcc	AltConf	Trace
			Total	C	N	O	S			
4	F	349	Total	C	N	O	S	0	0	0
			2854	1829	491	520	14			

There are 6 discrepancies between the modelled and reference sequences:

Chain	Residue	Modelled	Actual	Comment	Reference
F	379	HIS	-	expression tag	UNP E1BQ43
F	380	HIS	-	expression tag	UNP E1BQ43
F	381	HIS	-	expression tag	UNP E1BQ43
F	382	HIS	-	expression tag	UNP E1BQ43
F	383	HIS	-	expression tag	UNP E1BQ43
F	384	HIS	-	expression tag	UNP E1BQ43

- Molecule 5 is GUANOSINE-5'-TRIPHOSPHATE (three-letter code: GTP) (formula: $C_{10}H_{16}N_5O_{14}P_3$).



Mol	Chain	Residues	Atoms					ZeroOcc	AltConf
			Total	C	N	O	P		
5	A	1	Total	C	N	O	P	0	0
			32	10	5	14	3		
5	C	1	Total	C	N	O	P	0	0
			32	10	5	14	3		

- Molecule 6 is MAGNESIUM ION (three-letter code: MG) (formula: Mg).

Mol	Chain	Residues	Atoms		ZeroOcc	AltConf
6	A	1	Total	Mg	0	0
			1	1		
6	B	1	Total	Mg	0	0
			1	1		
6	C	1	Total	Mg	0	0
			1	1		
6	D	1	Total	Mg	0	0
			1	1		

Continued on next page...

Continued from previous page...

Mol	Chain	Residues	Atoms		ZeroOcc	AltConf
6	F	1	Total	Mg	0	0
			1	1		

- Molecule 7 is CALCIUM ION (three-letter code: CA) (formula: Ca).

Mol	Chain	Residues	Atoms		ZeroOcc	AltConf
7	A	2	Total	Ca	0	0
			2	2		
7	B	1	Total	Ca	0	0
			1	1		
7	C	1	Total	Ca	0	0
			1	1		

- Molecule 8 is 1-[4-(4-chlorophenyl)piperazin-1-yl]ethan-1-one (three-letter code: WNY) (formula: C₁₂H₁₅ClN₂O) (labeled as "Ligand of Interest" by depositor).

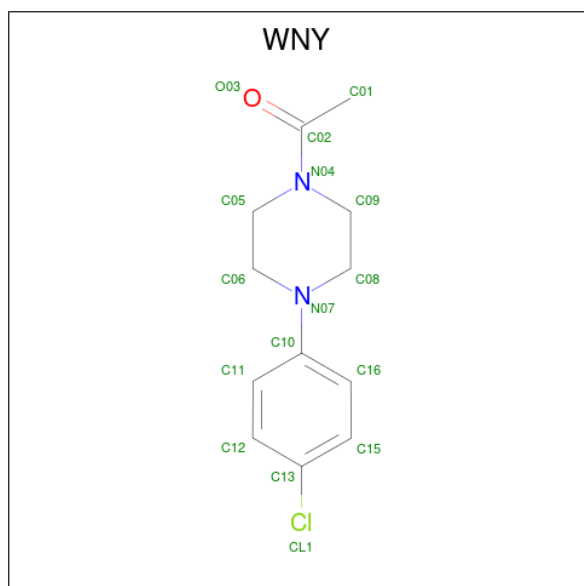

Mol	Chain	Residues	Atoms					ZeroOcc	AltConf	
8	A	1	Total	C	Cl	H	N	O	0	0
			31	12	1	15	2	1		
8	B	1	Total	C	Cl	H	N	O	0	0
			31	12	1	15	2	1		
8	B	1	Total	C	Cl	H	N	O	0	0
			31	12	1	15	2	1		
8	C	1	Total	C	Cl	H	N	O	0	0
			31	12	1	15	2	1		
8	C	1	Total	C	Cl	H	N	O	0	0
			31	12	1	15	2	1		

Mol	Chain	Residues	Atoms					ZeroOcc	AltConf
			Total	C	N	O	S		
10	B	1	12	6	1	4	1	0	0

- Molecule 11 is PHOSPHOMETHYLPHOSPHONIC ACID ADENYLATE ESTER (three-letter code: ACP) (formula: C₁₁H₁₈N₅O₁₂P₃).

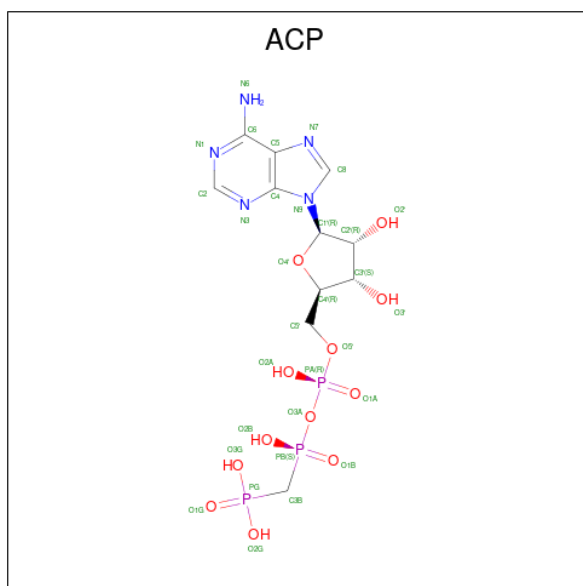

Mol	Chain	Residues	Atoms					ZeroOcc	AltConf
			Total	C	N	O	P		
11	F	1	31	11	5	12	3	0	0

- Molecule 12 is water.

Mol	Chain	Residues	Atoms		ZeroOcc	AltConf
12	A	68	Total	O	0	0
			68	68		
12	B	70	Total	O	0	0
			70	70		
12	C	178	Total	O	0	0
			178	178		
12	D	32	Total	O	0	0
			32	32		
12	E	10	Total	O	0	0
			10	10		
12	F	15	Total	O	0	0
			15	15		

3 Residue-property plots [i](#)

These plots are drawn for all protein, RNA, DNA and oligosaccharide chains in the entry. The first graphic for a chain summarises the proportions of the various outlier classes displayed in the second graphic. The second graphic shows the sequence view annotated by issues in geometry and electron density. Residues are color-coded according to the number of geometric quality criteria for which they contain at least one outlier: green = 0, yellow = 1, orange = 2 and red = 3 or more. A red dot above a residue indicates a poor fit to the electron density ($RSRZ > 2$). Stretches of 2 or more consecutive residues without any outlier are shown as a green connector. Residues present in the sample, but not in the model, are shown in grey.

- Molecule 1: Tubulin alpha-1B chain

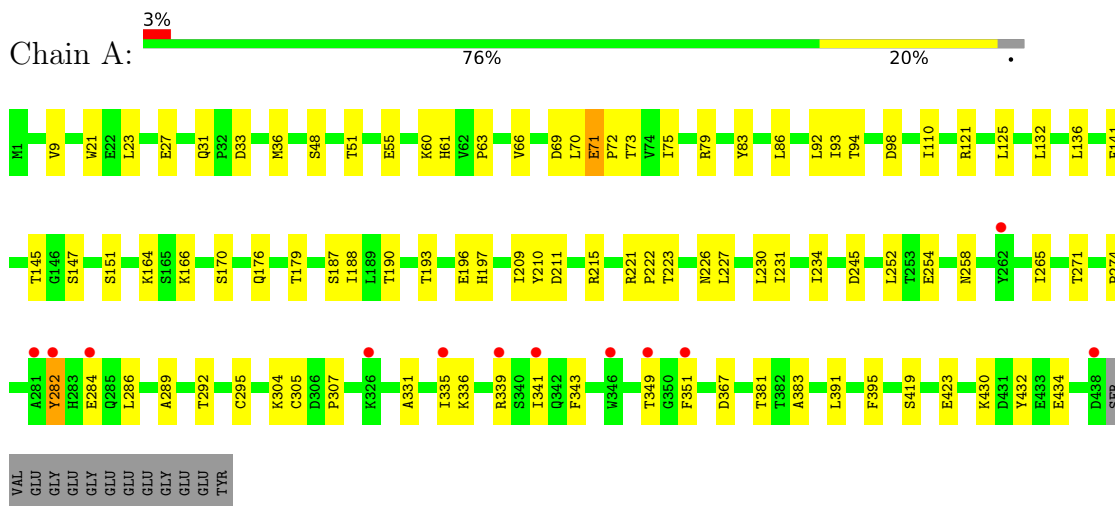

- Molecule 1: Tubulin alpha-1B chain

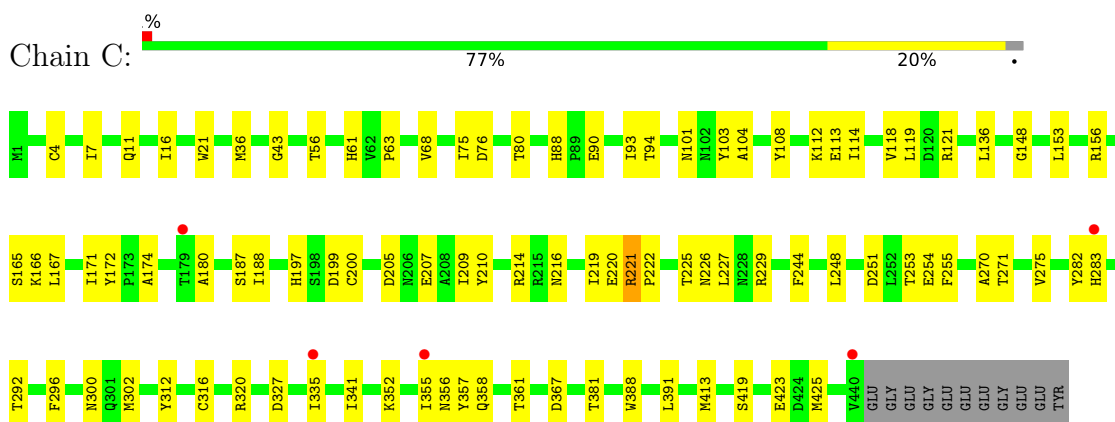

- Molecule 2: Tubulin beta-2B chain

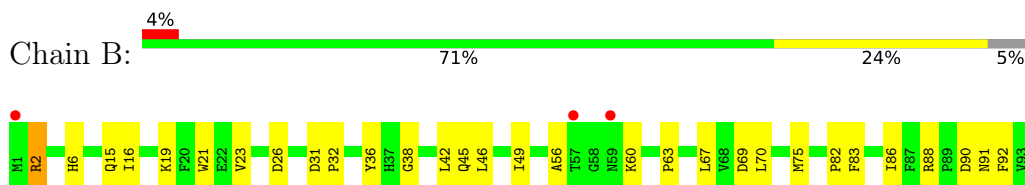

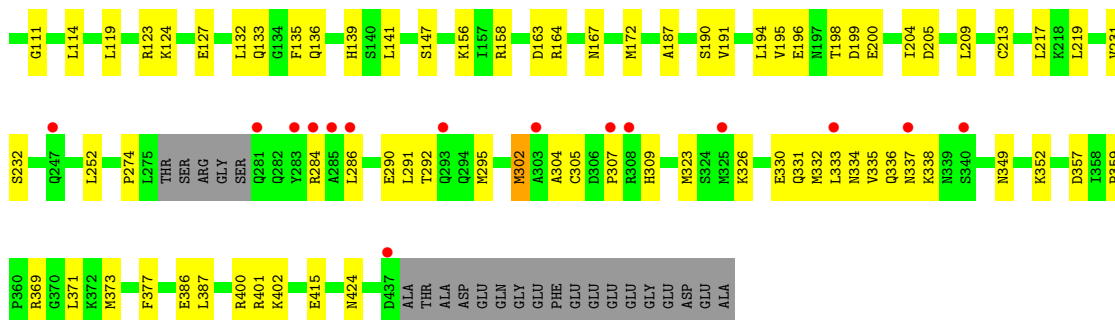

• Molecule 2: Tubulin beta-2B chain

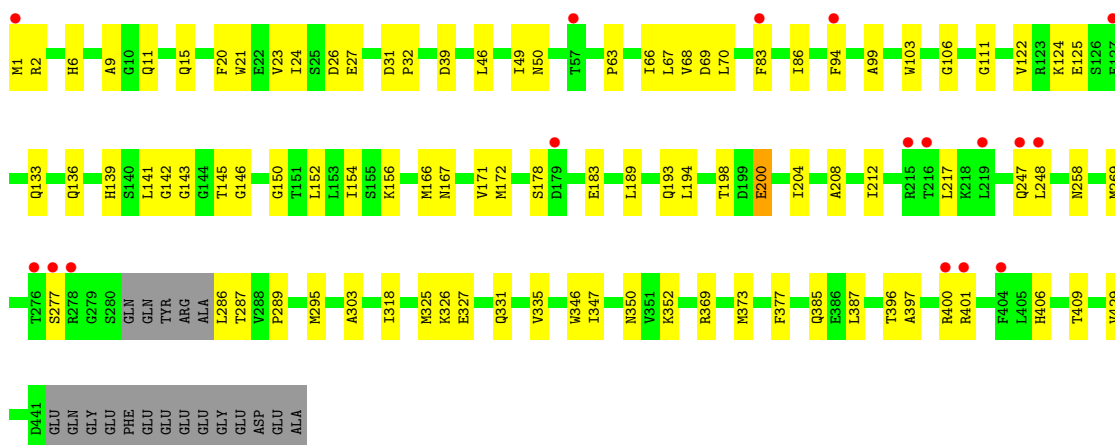
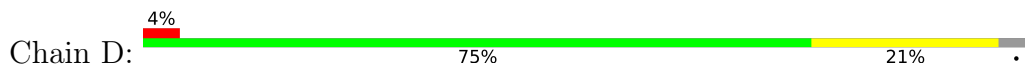

• Molecule 3: Stathmin-4

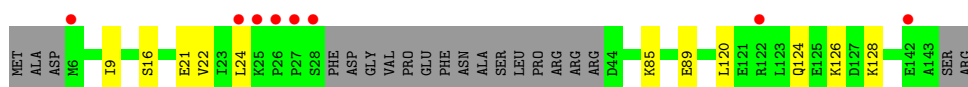
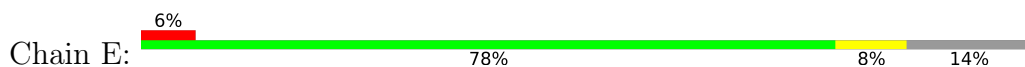

• Molecule 4: Tubulin-Tyrosine Ligase

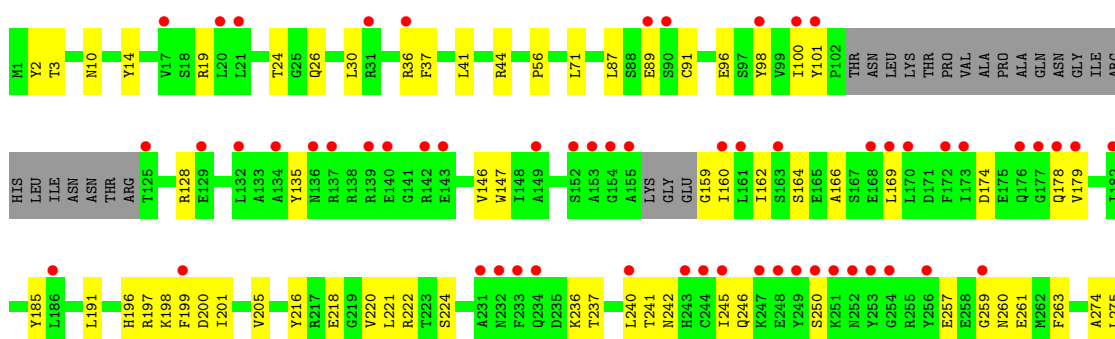



4 Data and refinement statistics

Property	Value	Source
Space group	P 21 21 21	Depositor
Cell constants a, b, c, α , β , γ	104.25Å 157.05Å 178.16Å 90.00° 90.00° 90.00°	Depositor
Resolution (Å)	78.52 – 2.29 78.52 – 2.29	Depositor EDS
% Data completeness (in resolution range)	97.8 (78.52-2.29) 97.8 (78.52-2.29)	Depositor EDS
R_{merge}	0.13	Depositor
R_{sym}	(Not available)	Depositor
$\langle I/\sigma(I) \rangle$ ¹	2.12 (at 2.29Å)	Xtrriage
Refinement program	PHENIX 1.18.2_3874	Depositor
R, R_{free}	0.208 , 0.244 0.208 , 0.244	Depositor DCC
R_{free} test set	1962 reflections (1.52%)	wwPDB-VP
Wilson B-factor (Å ²)	46.1	Xtrriage
Anisotropy	0.201	Xtrriage
Bulk solvent k_{sol} (e/Å ³), B_{sol} (Å ²)	0.32 , 40.5	EDS
L-test for twinning ²	$\langle L \rangle = 0.49$, $\langle L^2 \rangle = 0.33$	Xtrriage
Estimated twinning fraction	No twinning to report.	Xtrriage
F_o, F_c correlation	0.95	EDS
Total number of atoms	18111	wwPDB-VP
Average B, all atoms (Å ²)	63.0	wwPDB-VP

Xtrriage's analysis on translational NCS is as follows: *The largest off-origin peak in the Patterson function is 2.43% of the height of the origin peak. No significant pseudotranslation is detected.*

¹Intensities estimated from amplitudes.

²Theoretical values of $\langle |L| \rangle$, $\langle L^2 \rangle$ for acentric reflections are 0.5, 0.333 respectively for untwinned datasets, and 0.375, 0.2 for perfectly twinned datasets.

5 Model quality

5.1 Standard geometry

Bond lengths and bond angles in the following residue types are not validated in this section: CA, GTP, ACP, GDP, MG, MES, WNY

The Z score for a bond length (or angle) is the number of standard deviations the observed value is removed from the expected value. A bond length (or angle) with $|Z| > 5$ is considered an outlier worth inspection. RMSZ is the root-mean-square of all Z scores of the bond lengths (or angles).

Mol	Chain	Bond lengths		Bond angles	
		RMSZ	# Z >5	RMSZ	# Z >5
1	A	0.25	0/3502	0.42	0/4754
1	C	0.26	0/3530	0.43	0/4792
2	B	0.25	0/3398	0.41	0/4601
2	D	0.25	0/3416	0.41	0/4626
3	E	0.25	0/1022	0.36	0/1356
4	F	0.24	0/2921	0.40	0/3946
All	All	0.25	0/17789	0.41	0/24075

There are no bond length outliers.

There are no bond angle outliers.

There are no chirality outliers.

There are no planarity outliers.

5.2 Too-close contacts

In the following table, the Non-H and H(model) columns list the number of non-hydrogen atoms and hydrogen atoms in the chain respectively. The H(added) column lists the number of hydrogen atoms added and optimized by MolProbity. The Clashes column lists the number of clashes within the asymmetric unit, whereas Symm-Clashes lists symmetry-related clashes.

Mol	Chain	Non-H	H(model)	H(added)	Clashes	Symm-Clashes
1	A	3424	0	3335	74	0
1	C	3452	0	3357	64	0
2	B	3324	0	3198	84	0
2	D	3343	0	3222	68	0
3	E	1014	0	1029	10	0
4	F	2854	0	2815	59	0
5	A	32	0	12	1	0

Continued on next page...

Continued from previous page...

Mol	Chain	Non-H	H(model)	H(added)	Clashes	Symm-Clashes
5	C	32	0	12	0	0
6	A	1	0	0	0	0
6	B	1	0	0	0	0
6	C	1	0	0	0	0
6	D	1	0	0	0	0
6	F	1	0	0	0	0
7	A	2	0	0	0	0
7	B	1	0	0	0	0
7	C	1	0	0	0	0
8	A	16	15	0	0	0
8	B	32	30	0	1	0
8	C	32	30	0	0	0
9	B	28	0	12	1	0
9	D	28	0	12	1	0
10	B	12	0	12	2	0
11	F	31	0	14	4	0
12	A	68	0	0	2	0
12	B	70	0	0	3	0
12	C	178	0	0	1	0
12	D	32	0	0	1	0
12	E	10	0	0	0	0
12	F	15	0	0	0	0
All	All	18036	75	17030	346	0

The all-atom clashscore is defined as the number of clashes found per 1000 atoms (including hydrogen atoms). The all-atom clashscore for this structure is 10.

All (346) close contacts within the same asymmetric unit are listed below, sorted by their clash magnitude.

Atom-1	Atom-2	Interatomic distance (Å)	Clash overlap (Å)
2:D:295:MET:HE2	2:D:377:PHE:HB2	1.45	0.99
1:C:209:ILE:HD11	1:C:302:MET:HE3	1.48	0.92
4:F:236:LYS:HB3	4:F:240:LEU:HD13	1.57	0.86
2:D:217:LEU:HA	2:D:277:SER:HB3	1.60	0.84
4:F:241:THR:OG1	11:F:401:ACP:O3'	1.97	0.81
2:D:83:PHE:O	2:D:86:ILE:HG22	1.84	0.78
1:A:71:GLU:OE2	1:A:73:THR:OG1	2.00	0.77
4:F:331:GLU:OE2	11:F:401:ACP:O3G	2.03	0.76
2:B:274:PRO:HB3	2:B:286:LEU:HD22	1.68	0.73
1:C:93:ILE:HD11	1:C:121:ARG:HG3	1.71	0.73
2:D:136:GLN:HA	2:D:167:ASN:O	1.88	0.73

Continued on next page...

Continued from previous page...

Atom-1	Atom-2	Interatomic distance (Å)	Clash overlap (Å)
1:C:270:ALA:O	1:C:302:MET:HG2	1.89	0.72
2:B:83:PHE:O	2:B:86:ILE:HG22	1.91	0.70
1:A:211:ASP:OD2	1:A:304:LYS:NZ	2.20	0.69
2:D:397:ALA:HA	2:D:400:ARG:NH1	2.07	0.69
1:A:336:LYS:HG3	3:E:24:LEU:HD13	1.73	0.69
2:B:67:LEU:HD22	2:B:92:PHE:CE2	2.28	0.68
1:C:76:ASP:O	1:C:80:THR:HG22	1.93	0.68
2:B:16:ILE:HD13	2:B:231:VAL:HG11	1.75	0.68
1:C:254:GLU:HG2	1:C:352:LYS:HE2	1.75	0.68
2:B:337:ASN:OD1	4:F:36:ARG:HD3	1.93	0.67
4:F:200:ASP:OD1	4:F:222:ARG:HB2	1.94	0.67
2:B:209:LEU:CD2	2:B:302:MET:HG2	2.24	0.67
1:A:381:THR:HG22	1:A:383:ALA:H	1.60	0.67
2:B:284:ARG:NH2	2:B:290:GLU:OE2	2.27	0.67
4:F:128:ARG:NH2	4:F:174:ASP:OD1	2.27	0.67
1:C:4[A]:CYS:SG	1:C:136:LEU:HG	2.34	0.67
2:D:397:ALA:O	2:D:401:ARG:NH1	2.28	0.67
2:D:2:ARG:NH1	12:D:601:HOH:O	2.23	0.66
1:A:210:TYR:CE1	1:A:222:PRO:HD2	2.31	0.66
2:B:209:LEU:HD21	2:B:302:MET:HG2	1.77	0.66
1:C:327:ASP:OD2	12:C:601:HOH:O	2.14	0.66
2:B:163:ASP:OD1	12:B:601:HOH:O	2.14	0.66
1:C:320:ARG:HA	1:C:356:ASN:O	1.96	0.66
2:B:21:TRP:CZ3	2:B:63:PRO:HB3	2.32	0.65
1:A:335:ILE:HG23	1:A:339:ARG:HG3	1.78	0.65
2:B:69:ASP:O	2:B:94:PHE:HA	1.97	0.65
2:B:2:ARG:HB2	2:B:133:GLN:HE21	1.63	0.64
4:F:318:ASP:OD2	11:F:401:ACP:O2G	2.15	0.64
4:F:348:GLN:NE2	4:F:352:ASP:OD1	2.30	0.64
1:C:226:ASN:ND2	1:C:367:ASP:OD2	2.31	0.64
2:B:286:LEU:HD12	2:B:290:GLU:OE1	1.99	0.63
1:C:209:ILE:HD11	1:C:302:MET:CE	2.27	0.62
2:B:295:MET:CG	2:B:377:PHE:HB2	2.29	0.62
4:F:371:PRO:HA	4:F:372:THR:O	2.00	0.62
1:A:351:PHE:HE1	3:E:24:LEU:HD11	1.65	0.61
2:B:133:GLN:OE1	2:B:252:LEU:HG	2.00	0.61
2:B:292:THR:HG22	2:B:335:VAL:HG21	1.82	0.61
1:C:165:SER:HA	1:C:199:ASP:OD2	2.00	0.61
3:E:85:LYS:O	3:E:89:GLU:HG3	2.00	0.61
2:D:2:ARG:HB3	2:D:133:GLN:CG	2.30	0.61
2:D:70:LEU:HD12	2:D:99:ALA:HB2	1.82	0.61

Continued on next page...

Continued from previous page...

Atom-1	Atom-2	Interatomic distance (Å)	Clash overlap (Å)
1:C:221:ARG:HG3	2:D:325:MET:HG2	1.82	0.60
3:E:128:LYS:O	3:E:128:LYS:HD3	2.01	0.60
1:C:209:ILE:HG22	1:C:227:LEU:HD22	1.83	0.60
1:A:166:LYS:HE2	1:A:197:HIS:O	2.02	0.60
1:A:289:ALA:HA	1:A:331:ALA:CB	2.31	0.60
4:F:14:TYR:HB3	4:F:41:LEU:HD13	1.82	0.60
4:F:147:TRP:HB2	4:F:169:LEU:HD11	1.83	0.60
1:A:71:GLU:HG2	1:A:72:PRO:HD2	1.84	0.59
2:B:305:CYS:O	2:B:307:PRO:HD3	2.02	0.59
3:E:120:LEU:O	3:E:124:GLN:HG3	2.01	0.59
4:F:242:ASN:HD22	4:F:245:ILE:HD12	1.67	0.59
1:C:11:GLN:HE22	2:D:247:GLN:NE2	2.01	0.59
1:C:292:THR:HG22	1:C:335:ILE:HD12	1.84	0.59
4:F:10:ASN:HB2	4:F:44:ARG:HH22	1.67	0.59
2:D:1:MET:HG3	2:D:50:ASN:HB2	1.84	0.58
1:A:209:ILE:HG23	1:A:230:LEU:HD23	1.84	0.58
4:F:371:PRO:CA	4:F:372:THR:HB	2.33	0.58
1:C:292:THR:HG22	1:C:335:ILE:CD1	2.34	0.58
1:A:245:ASP:HB3	3:E:16:SER:OG	2.03	0.58
2:D:141:LEU:HD12	2:D:172:MET:SD	2.43	0.58
2:D:269:MET:HG3	2:D:303:ALA:HB3	1.86	0.58
2:D:172:MET:HG3	2:D:387:LEU:HD11	1.84	0.58
1:A:21:TRP:CZ3	1:A:63:PRO:HB3	2.38	0.57
2:B:141:LEU:HD12	2:B:172:MET:SD	2.45	0.57
2:D:46:LEU:HA	2:D:49:ILE:HB	1.87	0.57
2:D:1:MET:CE	2:D:50:ASN:HB2	2.33	0.57
4:F:146:VAL:HG22	4:F:164:SER:HB3	1.85	0.57
2:B:424:ASN:HB3	12:B:634:HOH:O	2.04	0.57
1:C:11:GLN:HE22	2:D:247:GLN:HE22	1.51	0.57
4:F:147:TRP:HB2	4:F:169:LEU:CD1	2.35	0.56
2:B:334:ASN:OD1	2:B:338:LYS:HD3	2.05	0.56
1:A:187:SER:CB	1:A:391:LEU:HD21	2.36	0.56
1:C:296:PHE:CD1	1:C:335:ILE:HD13	2.40	0.56
2:D:26:ASP:OD2	2:D:369:ARG:HD2	2.06	0.56
4:F:371:PRO:HA	4:F:372:THR:C	2.25	0.56
2:D:327:GLU:O	2:D:331:GLN:HG2	2.06	0.56
1:A:289:ALA:HA	1:A:331:ALA:HB1	1.88	0.55
4:F:197:ARG:NH1	4:F:257:GLU:OE2	2.25	0.55
2:B:123:ARG:O	2:B:127:GLU:HG3	2.06	0.55
1:C:214:ARG:HG2	1:C:219:ILE:O	2.06	0.55
1:A:141:PHE:CE1	1:A:170:SER:HB3	2.42	0.55

Continued on next page...

Continued from previous page...

Atom-1	Atom-2	Interatomic distance (Å)	Clash overlap (Å)
1:A:209:ILE:HG22	1:A:227:LEU:HD22	1.89	0.55
2:B:295:MET:HG2	2:B:377:PHE:HB2	1.89	0.55
4:F:3:THR:OG1	4:F:37:PHE:HA	2.07	0.54
1:A:179:THR:HA	2:B:352:LYS:HD2	1.89	0.54
4:F:3:THR:HB	4:F:30:LEU:HD11	1.89	0.54
1:A:292:THR:HG22	1:A:335:ILE:HD12	1.88	0.54
2:D:154:ILE:HG23	2:D:166:MET:HG2	1.89	0.54
4:F:236:LYS:HB3	4:F:240:LEU:CD1	2.35	0.54
2:B:36:TYR:CD1	2:B:46:LEU:HD21	2.42	0.54
2:D:11:GLN:O	2:D:15:GLN:HG2	2.08	0.54
1:A:211:ASP:HB3	1:A:215:ARG:NH2	2.23	0.54
1:A:226:ASN:ND2	1:A:367:ASP:OD2	2.41	0.54
2:B:204:ILE:HD13	2:B:231:VAL:HG13	1.89	0.54
2:D:1:MET:HG3	2:D:50:ASN:CB	2.38	0.54
1:C:312:TYR:CD2	1:C:341:ILE:HG23	2.43	0.53
4:F:24:THR:O	4:F:26:GLN:HG3	2.08	0.53
2:D:21:TRP:CZ3	2:D:63:PRO:HB3	2.43	0.53
1:A:292:THR:HG22	1:A:335:ILE:CD1	2.39	0.53
2:B:333:LEU:O	2:B:337:ASN:ND2	2.42	0.53
1:A:69:ASP:O	1:A:94:THR:HA	2.09	0.53
1:A:227:LEU:O	1:A:231:ILE:HG13	2.09	0.53
1:A:430:LYS:HE2	1:A:434:GLU:OE2	2.08	0.53
2:D:6:HIS:CD2	2:D:21:TRP:HE1	2.26	0.53
4:F:205:VAL:HG21	4:F:291:ILE:HD13	1.91	0.53
2:D:2:ARG:HB3	2:D:133:GLN:HG2	1.91	0.53
1:C:174:ALA:HB1	1:C:207:GLU:HB2	1.90	0.53
2:B:136:GLN:HA	2:B:167:ASN:O	2.09	0.53
2:B:15:GLN:NE2	9:B:501:GDP:O6	2.42	0.53
1:A:136:LEU:HD21	1:A:252:LEU:CD2	2.39	0.52
1:A:71:GLU:HG2	1:A:72:PRO:CD	2.38	0.52
2:B:19:LYS:O	2:B:23:VAL:HG23	2.08	0.52
2:B:323:MET:HE1	2:B:373:MET:HB2	1.90	0.52
1:C:21:TRP:CZ3	1:C:63:PRO:HB3	2.45	0.52
2:D:152:LEU:O	2:D:156:LYS:HG2	2.09	0.52
1:A:71:GLU:HG2	1:A:72:PRO:N	2.24	0.52
2:B:88:ARG:NH1	2:B:90:ASP:HB2	2.24	0.52
2:B:6:HIS:CD2	2:B:21:TRP:HE1	2.27	0.52
4:F:371:PRO:HA	4:F:372:THR:HB	1.89	0.52
2:B:332:MET:O	2:B:336:GLN:HG3	2.10	0.51
2:B:26:ASP:OD1	2:B:369:ARG:NH2	2.44	0.51
4:F:10:ASN:CB	4:F:44:ARG:HH22	2.23	0.51

Continued on next page...

Continued from previous page...

Atom-1	Atom-2	Interatomic distance (Å)	Clash overlap (Å)
2:B:88:ARG:HH11	2:B:90:ASP:HB2	1.75	0.51
2:D:103:TRP:CE3	2:D:189:LEU:HD13	2.46	0.51
2:B:286:LEU:HD23	2:B:291:LEU:CD2	2.40	0.51
2:D:248:LEU:HD11	2:D:352:LYS:HB3	1.92	0.50
2:D:318:ILE:N	2:D:318:ILE:HD12	2.25	0.50
4:F:198:LYS:HG2	4:F:199:PHE:H	1.76	0.50
2:D:1:MET:HE2	2:D:50:ASN:HB2	1.92	0.50
2:D:287:THR:HB	2:D:289:PRO:HD2	1.92	0.50
1:A:36:MET:HB3	1:A:61:HIS:CE1	2.46	0.50
2:D:20:PHE:CZ	2:D:24:ILE:HD13	2.46	0.50
4:F:159:GLY:C	4:F:160:ILE:HD12	2.31	0.50
1:A:75:ILE:HD12	1:A:94:THR:HG22	1.94	0.50
2:B:205:ASP:OD2	2:B:304:ALA:HB3	2.12	0.50
1:C:248:LEU:HD13	1:C:355:ILE:HD12	1.93	0.50
1:C:93:ILE:HG22	1:C:114:ILE:HD11	1.93	0.50
2:B:124:LYS:HD3	2:B:124:LYS:C	2.32	0.50
2:B:167:ASN:ND2	2:B:200:GLU:HB2	2.27	0.50
1:A:83:TYR:CD2	1:A:86:LEU:HD11	2.47	0.49
1:A:351:PHE:O	3:E:22:VAL:HG12	2.13	0.49
1:C:43:GLY:HA2	1:C:56:THR:O	2.11	0.49
1:A:430:LYS:O	1:A:434:GLU:HG3	2.12	0.49
2:B:400:ARG:HG3	2:B:401:ARG:HG2	1.94	0.49
2:D:396:THR:O	2:D:400:ARG:HG2	2.12	0.49
1:A:21:TRP:CE3	1:A:63:PRO:HB3	2.48	0.49
1:A:98:ASP:HB2	5:A:501:GTP:O2G	2.12	0.49
1:C:188:ILE:HG13	1:C:425:MET:HG3	1.94	0.49
2:B:191:VAL:O	2:B:195:VAL:HG23	2.13	0.49
2:D:67:LEU:N	2:D:67:LEU:HD12	2.27	0.49
2:B:326:LYS:O	2:B:330:GLU:HG3	2.12	0.49
1:C:210:TYR:CZ	1:C:222:PRO:HD2	2.48	0.49
1:A:223:THR:O	1:A:227:LEU:HG	2.12	0.49
2:B:359:PRO:HB2	2:B:371:LEU:O	2.13	0.49
2:D:21:TRP:CE3	2:D:63:PRO:HB3	2.47	0.48
1:A:141:PHE:O	1:A:147:SER:HB3	2.14	0.48
2:B:88:ARG:NH1	2:B:90:ASP:OD2	2.47	0.48
2:D:143:GLY:HA3	9:D:501:GDP:O3A	2.13	0.48
2:D:124:LYS:C	2:D:124:LYS:HD3	2.34	0.48
2:D:23:VAL:O	2:D:27:GLU:HG3	2.14	0.48
2:D:106:GLY:O	2:D:111:GLY:HA3	2.13	0.48
2:D:171:VAL:HA	2:D:204:ILE:O	2.14	0.48
2:B:158:ARG:NH1	2:B:196:GLU:O	2.47	0.48

Continued on next page...

Continued from previous page...

Atom-1	Atom-2	Interatomic distance (Å)	Clash overlap (Å)
2:B:349:ASN:O	2:B:352:LYS:HE2	2.12	0.48
2:D:66:ILE:HD12	2:D:122:VAL:HG22	1.96	0.48
4:F:280:GLU:OE1	4:F:284:LEU:HD23	2.14	0.48
2:B:213:CYS:HA	2:B:217:LEU:HB2	1.95	0.48
1:A:132:LEU:O	1:A:164:LYS:NZ	2.46	0.48
1:A:265:ILE:HG23	1:A:432:TYR:CE1	2.49	0.48
1:A:271:THR:HG21	1:A:295:CYS:HA	1.96	0.48
2:D:31:ASP:HB2	2:D:32:PRO:HD2	1.95	0.48
2:D:295:MET:CE	2:D:377:PHE:HB2	2.32	0.48
1:A:31:GLN:HB2	1:A:33:ASP:OD1	2.14	0.47
1:C:68:VAL:HG11	1:C:118:VAL:HG21	1.95	0.47
11:F:401:ACP:O3G	11:F:401:ACP:O1B	2.32	0.47
2:D:387:LEU:HD23	2:D:387:LEU:C	2.34	0.47
1:A:336:LYS:HG3	3:E:24:LEU:CD1	2.42	0.47
8:B:506:WNY:O03	1:C:352:LYS:HA	2.14	0.47
1:C:255:PHE:CD1	1:C:316:CYS:HB3	2.50	0.47
2:B:56:ALA:HB3	2:B:60:LYS:HB2	1.96	0.47
2:B:23:VAL:HG21	2:B:232:SER:HB3	1.96	0.47
1:A:176:GLN:HG3	4:F:56:PRO:HG3	1.96	0.47
2:B:164:ARG:HD2	12:B:647:HOH:O	2.14	0.47
4:F:197:ARG:HB2	4:F:224:SER:O	2.15	0.47
2:B:75:MET:HE3	2:B:92:PHE:CD2	2.50	0.47
1:C:244:PHE:CD1	1:C:358:GLN:HG2	2.50	0.47
1:C:101:ASN:ND2	1:C:180:ALA:HB2	2.29	0.46
2:D:31:ASP:HB2	2:D:32:PRO:CD	2.45	0.46
2:B:42:LEU:H	2:B:42:LEU:HD12	1.80	0.46
1:C:187:SER:HB3	1:C:391:LEU:HD21	1.97	0.46
4:F:198:LYS:O	4:F:199:PHE:HB3	2.14	0.46
2:B:70:LEU:HD12	2:B:99:ALA:HB2	1.96	0.46
1:A:136:LEU:HD21	1:A:252:LEU:HD21	1.95	0.46
1:A:289:ALA:HA	1:A:331:ALA:HB2	1.97	0.46
1:A:335:ILE:HG23	1:A:339:ARG:CG	2.45	0.46
1:C:248:LEU:HD12	1:C:357:TYR:OH	2.15	0.46
2:B:147:SER:OG	2:B:190:SER:OG	2.25	0.46
2:B:323:MET:HB3	2:B:373:MET:CE	2.46	0.46
1:C:244:PHE:CE1	1:C:358:GLN:HG2	2.51	0.46
2:B:2:ARG:HB2	2:B:133:GLN:NE2	2.27	0.46
2:B:172:MET:HG3	2:B:387:LEU:HD11	1.98	0.46
1:C:104:ALA:HB2	1:C:413:MET:SD	2.56	0.46
1:A:23:LEU:O	1:A:27:GLU:HG3	2.16	0.45
2:B:46:LEU:HA	2:B:49:ILE:HB	1.98	0.45

Continued on next page...

Continued from previous page...

Atom-1	Atom-2	Interatomic distance (Å)	Clash overlap (Å)
4:F:87:LEU:O	4:F:91:CYS:HB2	2.16	0.45
4:F:162:ILE:HD13	4:F:185:TYR:CE2	2.51	0.45
1:C:36:MET:HB3	1:C:61:HIS:CE1	2.51	0.45
1:C:174:ALA:CB	1:C:207:GLU:HB2	2.47	0.45
2:D:69:ASP:O	2:D:94:PHE:HA	2.16	0.45
2:D:347:ILE:HG22	2:D:350:ASN:HB3	1.99	0.45
4:F:100:ILE:HD12	4:F:128:ARG:HA	1.98	0.45
1:A:336:LYS:HD2	1:A:341:ILE:HD12	1.99	0.45
2:D:63:PRO:HD3	2:D:86:ILE:HG12	1.99	0.45
4:F:259:GLY:O	4:F:261:GLU:HG3	2.17	0.45
1:A:79:ARG:HG2	1:A:92:LEU:HD12	1.98	0.45
1:A:187:SER:HB3	1:A:391:LEU:HD21	1.99	0.45
2:D:406:HIS:HA	2:D:409:THR:OG1	2.18	0.45
1:A:70:LEU:HD13	1:A:110:ILE:HG21	1.99	0.44
1:A:196:GLU:OE1	1:A:196:GLU:HA	2.18	0.44
1:C:167:LEU:HG	1:C:200:CYS:HB3	2.00	0.44
1:C:282:TYR:O	1:C:283:HIS:HB2	2.17	0.44
2:D:208:ALA:O	2:D:212:ILE:HG13	2.17	0.44
2:B:38:GLY:HA3	2:B:45:GLN:OE1	2.17	0.44
2:B:132:LEU:HD21	2:B:135:PHE:CZ	2.52	0.44
1:C:7:ILE:HG21	1:C:153:LEU:HD21	1.99	0.44
1:C:21:TRP:CE3	1:C:63:PRO:HB3	2.53	0.44
1:C:166:LYS:HE2	1:C:197:HIS:O	2.16	0.44
1:C:220:GLU:HB3	2:D:326:LYS:HD2	1.99	0.44
2:D:248:LEU:HD21	2:D:352:LYS:HB3	1.99	0.44
4:F:377:LYS:HD3	4:F:379:HIS:NE2	2.32	0.44
1:A:93:ILE:HD11	1:A:121:ARG:HG3	1.98	0.44
1:C:75:ILE:HD12	1:C:94:THR:HG22	1.99	0.44
2:D:2:ARG:HB2	2:D:133:GLN:HE21	1.83	0.44
4:F:242:ASN:HD22	4:F:245:ILE:CD1	2.31	0.44
1:A:274:PRO:HB3	1:A:286:LEU:HD12	1.98	0.44
2:B:164:ARG:O	10:B:504:MES:H31	2.17	0.44
1:A:419:SER:O	1:A:423:GLU:HG3	2.18	0.44
1:C:251:ASP:OD2	1:C:253:THR:OG1	2.29	0.44
2:B:21:TRP:CE3	2:B:63:PRO:HB3	2.52	0.44
2:B:75:MET:HE3	2:B:92:PHE:HD2	1.83	0.44
1:C:271:THR:HG23	1:C:300:ASN:O	2.18	0.44
1:A:48:SER:O	1:A:51:THR:HG23	2.18	0.43
2:B:309:HIS:ND1	2:B:386:GLU:OE2	2.50	0.43
2:B:88:ARG:HD3	2:B:91:ASN:OD1	2.19	0.43
4:F:101:TYR:CD2	4:F:179:VAL:HG22	2.53	0.43

Continued on next page...

Continued from previous page...

Atom-1	Atom-2	Interatomic distance (Å)	Clash overlap (Å)
4:F:296:MET:SD	4:F:380:HIS:HB2	2.57	0.43
4:F:371:PRO:N	4:F:372:THR:HB	2.33	0.43
2:D:69:ASP:HA	2:D:145:THR:HG21	2.00	0.43
1:A:83:TYR:HD2	1:A:86:LEU:HD11	1.83	0.43
1:A:151:SER:HB2	1:A:193:THR:OG1	2.19	0.43
2:B:213:CYS:HB3	2:B:219:LEU:HD12	2.01	0.43
1:A:55:GLU:HA	1:A:60:LYS:O	2.19	0.43
2:B:323:MET:HB3	2:B:373:MET:HE2	2.00	0.43
2:D:124:LYS:HD3	2:D:125:GLU:N	2.34	0.43
1:A:66:VAL:HG23	1:A:125:LEU:HD12	2.01	0.43
4:F:205:VAL:CG2	4:F:291:ILE:HD13	2.49	0.43
2:B:67:LEU:N	2:B:67:LEU:HD12	2.34	0.42
1:A:254:GLU:HG2	1:A:258:ASN:ND2	2.34	0.42
4:F:191:LEU:HD12	4:F:196:HIS:CE1	2.55	0.42
4:F:246:GLN:HB3	4:F:260:ASN:ND2	2.33	0.42
1:A:75:ILE:HD12	1:A:94:THR:CG2	2.50	0.42
2:B:119:LEU:HD11	2:B:156:LYS:HB3	2.01	0.42
2:D:194:LEU:HD22	2:D:198:THR:HG21	2.01	0.42
1:C:88:HIS:HE1	1:C:90:GLU:HG3	1.85	0.42
1:C:103:TYR:CE2	1:C:148:GLY:HA2	2.54	0.42
1:C:225:THR:O	1:C:229:ARG:HG2	2.19	0.42
1:A:176:GLN:HB2	12:A:636:HOH:O	2.19	0.42
2:D:142:GLY:O	2:D:183:GLU:HG2	2.20	0.42
4:F:19:ARG:HD2	4:F:19:ARG:O	2.20	0.42
1:A:188:ILE:HD12	1:A:395:PHE:HB2	2.02	0.42
1:A:234:ILE:HD12	1:A:234:ILE:N	2.35	0.42
1:A:335:ILE:CG2	1:A:339:ARG:HG3	2.48	0.42
2:B:323:MET:CE	2:B:373:MET:HB2	2.50	0.42
2:D:193:GLN:OE1	3:E:126:LYS:NZ	2.38	0.42
4:F:96:GLU:OE2	4:F:98:TYR:OH	2.26	0.42
4:F:274:ALA:HB3	4:F:275:LEU:HD22	2.02	0.42
1:A:187:SER:O	1:A:190:THR:HG22	2.20	0.42
1:A:265:ILE:HG23	1:A:432:TYR:CZ	2.54	0.42
1:A:305:CYS:O	1:A:307:PRO:HD3	2.19	0.42
2:B:209:LEU:HD23	2:B:302:MET:HG2	1.99	0.42
4:F:160:ILE:HD12	4:F:160:ILE:N	2.35	0.42
2:B:31:ASP:HB2	2:B:32:PRO:CD	2.50	0.41
2:B:42:LEU:HD12	2:B:42:LEU:N	2.35	0.41
1:C:16:ILE:CD1	1:C:171:ILE:HD11	2.50	0.41
2:D:385:GLN:HB2	2:D:429:VAL:HG13	2.02	0.41
4:F:201:ILE:HG12	4:F:221:LEU:HG	2.01	0.41

Continued on next page...

Continued from previous page...

Atom-1	Atom-2	Interatomic distance (Å)	Clash overlap (Å)
4:F:240:LEU:HD12	4:F:240:LEU:N	2.35	0.41
4:F:299:GLU:HB3	4:F:300:PRO:HD3	2.02	0.41
2:D:1:MET:CG	2:D:50:ASN:HB2	2.49	0.41
2:B:274:PRO:HB3	2:B:286:LEU:CD2	2.46	0.41
2:B:402:LYS:HE2	2:B:415:GLU:OE1	2.20	0.41
2:B:31:ASP:HB2	2:B:32:PRO:HD2	2.03	0.41
2:B:114:LEU:O	2:B:114:LEU:HG	2.20	0.41
2:D:167:ASN:OD1	2:D:200:GLU:HG3	2.21	0.41
1:C:119:LEU:HD11	1:C:156:ARG:HB3	2.01	0.41
1:C:312:TYR:CE2	1:C:341:ILE:HG23	2.55	0.41
1:A:188:ILE:HD12	1:A:395:PHE:CD2	2.56	0.41
4:F:71:LEU:HD11	4:F:294:CYS:HB3	2.03	0.41
2:B:199:ASP:OD1	10:B:504:MES:H62	2.21	0.41
1:C:172:TYR:HB3	1:C:205:ASP:HA	2.01	0.41
2:D:346:TRP:CE3	2:D:347:ILE:HG13	2.56	0.41
3:E:9:ILE:HG13	3:E:21:GLU:HB3	2.03	0.41
4:F:237:THR:O	4:F:246:GLN:NE2	2.51	0.41
1:A:193:THR:HG23	12:A:632:HOH:O	2.20	0.41
2:B:21:TRP:CH2	2:B:63:PRO:HB3	2.56	0.41
4:F:2:TYR:CE1	4:F:359:PHE:HB3	2.56	0.41
4:F:216:TYR:CZ	4:F:218:GLU:HB2	2.56	0.41
1:A:9:VAL:HG12	1:A:145:THR:HG22	2.03	0.41
1:A:234:ILE:HD12	1:A:234:ILE:H	1.85	0.41
2:B:187:ALA:O	2:B:191:VAL:HG23	2.21	0.41
2:B:331:GLN:O	2:B:335:VAL:HG23	2.20	0.41
1:C:216:ASN:HB3	1:C:275:VAL:O	2.20	0.41
2:D:9:ALA:HA	2:D:68:VAL:O	2.21	0.41
4:F:220:VAL:HG12	4:F:263:PHE:CE1	2.56	0.41
4:F:246:GLN:O	4:F:250:SER:HB3	2.20	0.41
1:C:108:TYR:O	1:C:112:LYS:HG2	2.21	0.41
1:C:112:LYS:NZ	1:C:113:GLU:OE2	2.54	0.41
1:C:180:ALA:HA	2:D:258:ASN:OD1	2.22	0.40
1:C:296:PHE:CE1	1:C:335:ILE:HD13	2.56	0.40
4:F:135:TYR:CZ	4:F:166:ALA:HB2	2.57	0.40
4:F:178:GLN:N	4:F:178:GLN:OE1	2.54	0.40
2:B:357:ASP:O	2:B:359:PRO:HD3	2.20	0.40
1:C:93:ILE:CD1	1:C:121:ARG:HG3	2.45	0.40
1:C:103:TYR:CD2	1:C:148:GLY:HA2	2.55	0.40
2:D:146:GLY:O	2:D:150:GLY:HA3	2.21	0.40
2:D:178:SER:HB3	2:D:183:GLU:OE2	2.21	0.40
2:D:286:LEU:O	2:D:373:MET:HE1	2.22	0.40

Continued on next page...

Continued from previous page...

Atom-1	Atom-2	Interatomic distance (Å)	Clash overlap (Å)
1:C:270:ALA:C	1:C:302:MET:HG2	2.41	0.40
1:C:388:TRP:CE3	1:C:425:MET:HE1	2.56	0.40
1:C:419:SER:O	1:C:423:GLU:HG3	2.21	0.40
1:A:343:PHE:CD1	1:A:349:THR:HG23	2.57	0.40
2:B:106:GLY:O	2:B:111:GLY:HA3	2.21	0.40
2:B:194:LEU:HD22	2:B:198:THR:HG21	2.02	0.40
4:F:320:MET:HE3	4:F:320:MET:HB3	1.96	0.40

There are no symmetry-related clashes.

5.3 Torsion angles [i](#)

5.3.1 Protein backbone [i](#)

In the following table, the Percentiles column shows the percent Ramachandran outliers of the chain as a percentile score with respect to all X-ray entries followed by that with respect to entries of similar resolution.

The Analysed column shows the number of residues for which the backbone conformation was analysed, and the total number of residues.

Mol	Chain	Analysed	Favoured	Allowed	Outliers	Percentiles	
1	A	436/451 (97%)	425 (98%)	10 (2%)	1 (0%)	47	58
1	C	440/451 (98%)	431 (98%)	9 (2%)	0	100	100
2	B	418/445 (94%)	406 (97%)	11 (3%)	1 (0%)	47	58
2	D	422/445 (95%)	407 (96%)	15 (4%)	0	100	100
3	E	119/143 (83%)	119 (100%)	0	0	100	100
4	F	341/384 (89%)	324 (95%)	17 (5%)	0	100	100
All	All	2176/2319 (94%)	2112 (97%)	62 (3%)	2 (0%)	51	64

All (2) Ramachandran outliers are listed below:

Mol	Chain	Res	Type
1	A	282	TYR
2	B	82	PRO

5.3.2 Protein sidechains [i](#)

In the following table, the Percentiles column shows the percent sidechain outliers of the chain as a percentile score with respect to all X-ray entries followed by that with respect to entries of similar resolution.

The Analysed column shows the number of residues for which the sidechain conformation was analysed, and the total number of residues.

Mol	Chain	Analysed	Rotameric	Outliers	Percentiles	
1	A	369/379 (97%)	365 (99%)	4 (1%)	73	86
1	C	373/379 (98%)	370 (99%)	3 (1%)	81	91
2	B	364/383 (95%)	361 (99%)	3 (1%)	81	91
2	D	368/383 (96%)	364 (99%)	4 (1%)	73	86
3	E	110/127 (87%)	110 (100%)	0	100	100
4	F	312/342 (91%)	311 (100%)	1 (0%)	92	97
All	All	1896/1993 (95%)	1881 (99%)	15 (1%)	81	91

All (15) residues with a non-rotameric sidechain are listed below:

Mol	Chain	Res	Type
1	A	71	GLU
1	A	221	ARG
1	A	282	TYR
1	A	284	GLU
2	B	2	ARG
2	B	139	HIS
2	B	302	MET
1	C	221	ARG
1	C	361	THR
1	C	381	THR
2	D	39	ASP
2	D	139	HIS
2	D	200	GLU
2	D	335	VAL
4	F	89	GLU

Sometimes sidechains can be flipped to improve hydrogen bonding and reduce clashes. All (21) such sidechains are listed below:

Mol	Chain	Res	Type
1	A	11	GLN
1	A	101	ASN

Continued on next page...

Continued from previous page...

Mol	Chain	Res	Type
1	A	300	ASN
2	B	15	GLN
2	B	167	ASN
2	B	282	GLN
2	B	294	GLN
2	B	300	ASN
2	B	424	ASN
1	C	11	GLN
1	C	285	GLN
1	C	300	ASN
1	C	406	HIS
2	D	96	GLN
2	D	294	GLN
2	D	300	ASN
4	F	229	ASN
4	F	242	ASN
4	F	269	GLN
4	F	333	ASN
4	F	380	HIS

5.3.3 RNA [i](#)

There are no RNA molecules in this entry.

5.4 Non-standard residues in protein, DNA, RNA chains [i](#)

There are no non-standard protein/DNA/RNA residues in this entry.

5.5 Carbohydrates [i](#)

There are no monosaccharides in this entry.

5.6 Ligand geometry [i](#)

Of 20 ligands modelled in this entry, 9 are monoatomic - leaving 11 for Mogul analysis.

In the following table, the Counts columns list the number of bonds (or angles) for which Mogul statistics could be retrieved, the number of bonds (or angles) that are observed in the model and the number of bonds (or angles) that are defined in the Chemical Component Dictionary. The Link column lists molecule types, if any, to which the group is linked. The Z score for a bond length (or angle) is the number of standard deviations the observed value is removed from the

expected value. A bond length (or angle) with $|Z| > 2$ is considered an outlier worth inspection. RMSZ is the root-mean-square of all Z scores of the bond lengths (or angles).

Mol	Type	Chain	Res	Link	Bond lengths			Bond angles		
					Counts	RMSZ	# $ Z > 2$	Counts	RMSZ	# $ Z > 2$
5	GTP	A	501	6	26,34,34	1.12	2 (7%)	32,54,54	1.35	5 (15%)
8	WNY	C	505	-	17,17,17	0.19	0	23,23,23	0.71	0
8	WNY	C	504	-	17,17,17	0.21	0	23,23,23	0.75	0
8	WNY	B	506	-	17,17,17	0.27	0	23,23,23	0.95	1 (4%)
8	WNY	A	505	-	17,17,17	0.24	0	23,23,23	0.82	1 (4%)
8	WNY	B	505	-	17,17,17	0.31	0	23,23,23	1.13	2 (8%)
9	GDP	B	501	6	24,30,30	0.93	1 (4%)	30,47,47	1.10	3 (10%)
11	ACP	F	401	6	27,33,33	1.41	5 (18%)	32,52,52	1.51	4 (12%)
5	GTP	C	501	6	26,34,34	1.14	2 (7%)	32,54,54	1.34	5 (15%)
9	GDP	D	501	6	24,30,30	0.95	1 (4%)	30,47,47	1.16	4 (13%)
10	MES	B	504	-	12,12,12	2.22	1 (8%)	14,16,16	1.98	5 (35%)

In the following table, the Chirals column lists the number of chiral outliers, the number of chiral centers analysed, the number of these observed in the model and the number defined in the Chemical Component Dictionary. Similar counts are reported in the Torsion and Rings columns. '-' means no outliers of that kind were identified.

Mol	Type	Chain	Res	Link	Chirals	Torsions	Rings
5	GTP	A	501	6	-	9/18/38/38	0/3/3/3
8	WNY	C	505	-	-	4/8/18/18	0/2/2/2
8	WNY	C	504	-	-	4/8/18/18	0/2/2/2
8	WNY	B	506	-	-	7/8/18/18	0/2/2/2
8	WNY	A	505	-	-	4/8/18/18	0/2/2/2
8	WNY	B	505	-	-	0/8/18/18	0/2/2/2
9	GDP	B	501	6	-	3/12/32/32	0/3/3/3
11	ACP	F	401	6	-	13/15/38/38	0/3/3/3
5	GTP	C	501	6	-	9/18/38/38	0/3/3/3
9	GDP	D	501	6	-	6/12/32/32	0/3/3/3
10	MES	B	504	-	-	4/6/14/14	0/1/1/1

All (12) bond length outliers are listed below:

Mol	Chain	Res	Type	Atoms	Z	Observed(Å)	Ideal(Å)
10	B	504	MES	C8-S	-7.42	1.67	1.77
5	A	501	GTP	C5-C6	-3.93	1.39	1.47

Continued on next page...

Continued from previous page...

Mol	Chain	Res	Type	Atoms	Z	Observed(Å)	Ideal(Å)
5	C	501	GTP	C5-C6	-3.93	1.39	1.47
11	F	401	ACP	PG-O2G	2.99	1.61	1.54
11	F	401	ACP	PB-O3A	2.98	1.61	1.58
11	F	401	ACP	PG-O3G	2.97	1.61	1.54
11	F	401	ACP	C5-C4	2.50	1.47	1.40
9	B	501	GDP	C6-N1	-2.37	1.34	1.37
9	D	501	GDP	C6-N1	-2.31	1.34	1.37
11	F	401	ACP	PB-O2B	2.25	1.61	1.56
5	A	501	GTP	C2-N3	2.13	1.38	1.33
5	C	501	GTP	C2-N3	2.13	1.38	1.33

All (30) bond angle outliers are listed below:

Mol	Chain	Res	Type	Atoms	Z	Observed(°)	Ideal(°)
11	F	401	ACP	PB-O3A-PA	-4.21	119.22	132.56
10	B	504	MES	C5-N4-C3	3.88	117.57	108.83
11	F	401	ACP	C3'-C2'-C1'	3.69	106.54	100.98
8	B	505	WNY	C08-N07-C06	3.60	119.46	111.52
11	F	401	ACP	N3-C2-N1	-3.17	123.73	128.68
10	B	504	MES	O1S-S-C8	3.11	110.66	106.92
5	C	501	GTP	C8-N7-C5	3.10	108.90	102.99
9	D	501	GDP	PA-O3A-PB	-3.09	122.24	132.83
5	A	501	GTP	C5-C6-N1	3.02	119.28	113.95
5	C	501	GTP	C5-C6-N1	3.00	119.25	113.95
5	A	501	GTP	C8-N7-C5	2.99	108.68	102.99
10	B	504	MES	O3S-S-C8	2.83	110.35	105.77
10	B	504	MES	C6-C5-N4	-2.83	105.81	110.10
5	A	501	GTP	PB-O3B-PG	-2.78	123.29	132.83
5	C	501	GTP	C2-N1-C6	-2.77	120.00	125.10
5	A	501	GTP	PA-O3A-PB	-2.72	123.48	132.83
5	C	501	GTP	PA-O3A-PB	-2.71	123.54	132.83
8	B	506	WNY	C08-N07-C06	2.67	117.41	111.52
9	B	501	GDP	PA-O3A-PB	-2.64	123.76	132.83
5	A	501	GTP	C2-N1-C6	-2.63	120.25	125.10
11	F	401	ACP	C4-C5-N7	-2.60	106.69	109.40
5	C	501	GTP	PB-O3B-PG	-2.45	124.41	132.83
9	B	501	GDP	C5-C6-N1	2.45	118.28	113.95
9	D	501	GDP	C8-N7-C5	2.42	107.59	102.99
8	B	505	WNY	C05-C06-N07	2.37	115.30	110.70
9	B	501	GDP	C8-N7-C5	2.28	107.34	102.99
10	B	504	MES	C7-N4-C5	2.27	117.03	111.23
8	A	505	WNY	C08-N07-C06	2.22	116.42	111.52

Continued on next page...

Continued from previous page...

Mol	Chain	Res	Type	Atoms	Z	Observed(°)	Ideal(°)
9	D	501	GDP	C5-C6-N1	2.21	117.85	113.95
9	D	501	GDP	C3'-C2'-C1'	2.01	104.00	100.98

There are no chirality outliers.

All (63) torsion outliers are listed below:

Mol	Chain	Res	Type	Atoms
5	A	501	GTP	C5'-O5'-PA-O1A
5	A	501	GTP	C5'-O5'-PA-O2A
5	C	501	GTP	C5'-O5'-PA-O1A
5	C	501	GTP	C5'-O5'-PA-O2A
8	A	505	WNY	C01-C02-N04-C05
8	A	505	WNY	C01-C02-N04-C09
8	A	505	WNY	O03-C02-N04-C05
8	A	505	WNY	O03-C02-N04-C09
8	B	506	WNY	C01-C02-N04-C05
8	B	506	WNY	C01-C02-N04-C09
8	B	506	WNY	O03-C02-N04-C05
8	B	506	WNY	O03-C02-N04-C09
8	C	504	WNY	C01-C02-N04-C05
8	C	504	WNY	C01-C02-N04-C09
8	C	504	WNY	O03-C02-N04-C05
8	C	504	WNY	O03-C02-N04-C09
8	C	505	WNY	C01-C02-N04-C05
8	C	505	WNY	C01-C02-N04-C09
8	C	505	WNY	O03-C02-N04-C05
8	C	505	WNY	O03-C02-N04-C09
9	B	501	GDP	C5'-O5'-PA-O1A
9	B	501	GDP	C5'-O5'-PA-O2A
9	D	501	GDP	C5'-O5'-PA-O1A
9	D	501	GDP	C5'-O5'-PA-O2A
10	B	504	MES	C8-C7-N4-C5
10	B	504	MES	C7-C8-S-O2S
10	B	504	MES	C7-C8-S-O3S
11	F	401	ACP	PB-C3B-PG-O1G
11	F	401	ACP	PB-C3B-PG-O2G
11	F	401	ACP	PB-C3B-PG-O3G
11	F	401	ACP	PG-C3B-PB-O1B
11	F	401	ACP	PG-C3B-PB-O2B
11	F	401	ACP	PG-C3B-PB-O3A
11	F	401	ACP	C5'-O5'-PA-O1A
11	F	401	ACP	C5'-O5'-PA-O2A

Continued on next page...

Continued from previous page...

Mol	Chain	Res	Type	Atoms
11	F	401	ACP	O4'-C4'-C5'-O5'
11	F	401	ACP	C3'-C4'-C5'-O5'
8	B	506	WNY	C16-C10-N07-C06
10	B	504	MES	C7-C8-S-O1S
5	C	501	GTP	PB-O3B-PG-O1G
5	A	501	GTP	PB-O3A-PA-O2A
5	C	501	GTP	PB-O3A-PA-O2A
5	A	501	GTP	C4'-C5'-O5'-PA
5	A	501	GTP	PB-O3A-PA-O1A
5	A	501	GTP	PB-O3B-PG-O1G
9	D	501	GDP	PA-O3A-PB-O1B
8	B	506	WNY	C11-C10-N07-C06
5	A	501	GTP	PB-O3B-PG-O2G
5	A	501	GTP	PB-O3B-PG-O3G
5	C	501	GTP	PB-O3B-PG-O2G
5	C	501	GTP	PB-O3B-PG-O3G
9	D	501	GDP	PA-O3A-PB-O2B
9	D	501	GDP	PA-O3A-PB-O3B
11	F	401	ACP	PB-O3A-PA-O1A
11	F	401	ACP	PB-O3A-PA-O2A
5	A	501	GTP	C5'-O5'-PA-O3A
5	C	501	GTP	C5'-O5'-PA-O3A
9	B	501	GDP	C5'-O5'-PA-O3A
9	D	501	GDP	C5'-O5'-PA-O3A
11	F	401	ACP	C5'-O5'-PA-O3A
5	C	501	GTP	PB-O3A-PA-O1A
5	C	501	GTP	C4'-C5'-O5'-PA
8	B	506	WNY	C11-C10-N07-C08

There are no ring outliers.

6 monomers are involved in 10 short contacts:

Mol	Chain	Res	Type	Clashes	Symm-Clashes
5	A	501	GTP	1	0
8	B	506	WNY	1	0
9	B	501	GDP	1	0
11	F	401	ACP	4	0
9	D	501	GDP	1	0
10	B	504	MES	2	0

The following is a two-dimensional graphical depiction of Mogul quality analysis of bond lengths, bond angles, torsion angles, and ring geometry for all instances of the Ligand of Interest. In

addition, ligands with molecular weight > 250 and outliers as shown on the validation Tables will also be included. For torsion angles, if less than 5% of the Mogul distribution of torsion angles is within 10 degrees of the torsion angle in question, then that torsion angle is considered an outlier. Any bond that is central to one or more torsion angles identified as an outlier by Mogul will be highlighted in the graph. For rings, the root-mean-square deviation (RMSD) between the ring in question and similar rings identified by Mogul is calculated over all ring torsion angles. If the average RMSD is greater than 60 degrees and the minimal RMSD between the ring in question and any Mogul-identified rings is also greater than 60 degrees, then that ring is considered an outlier. The outliers are highlighted in purple. The color gray indicates Mogul did not find sufficient equivalents in the CSD to analyse the geometry.

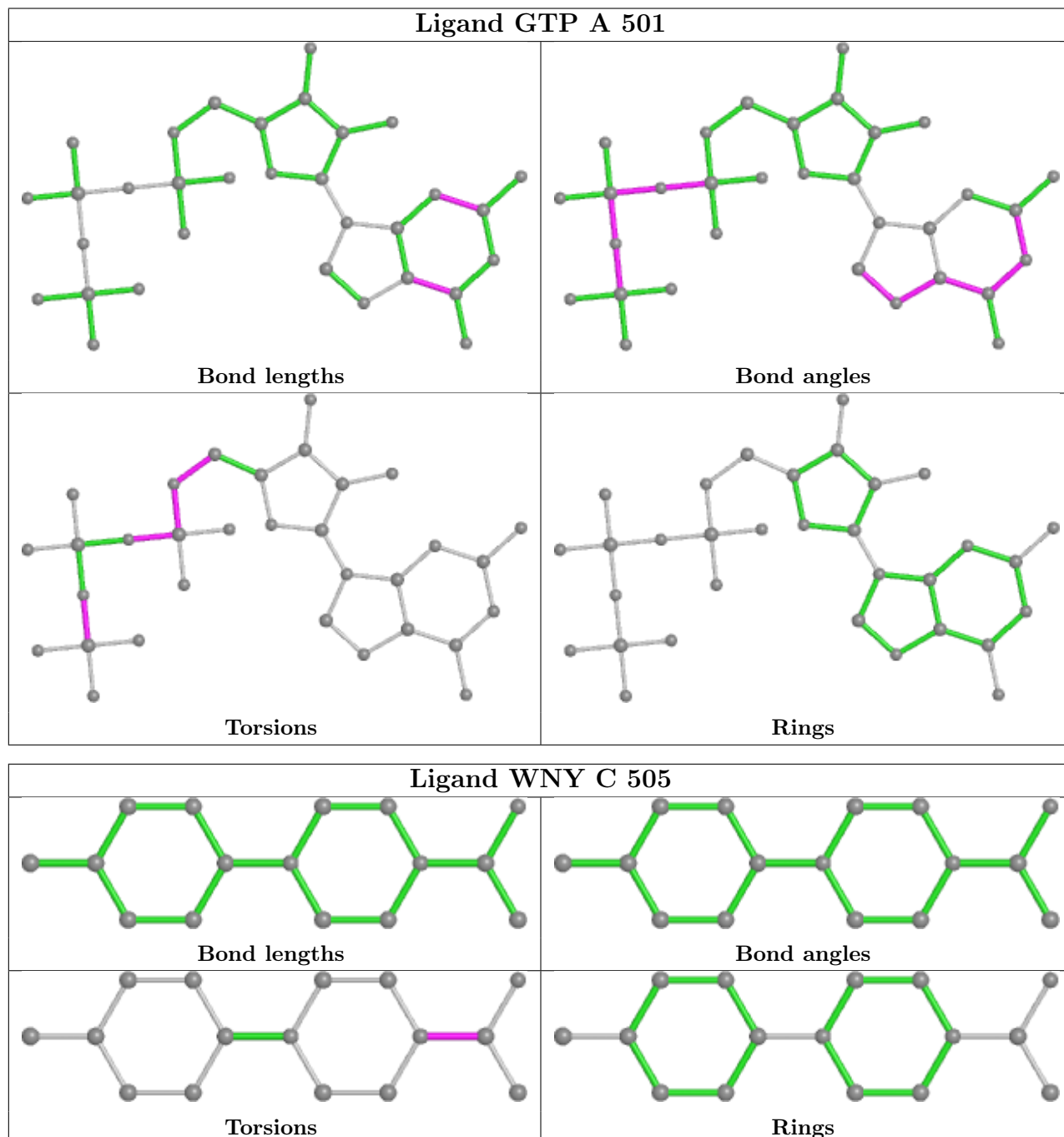

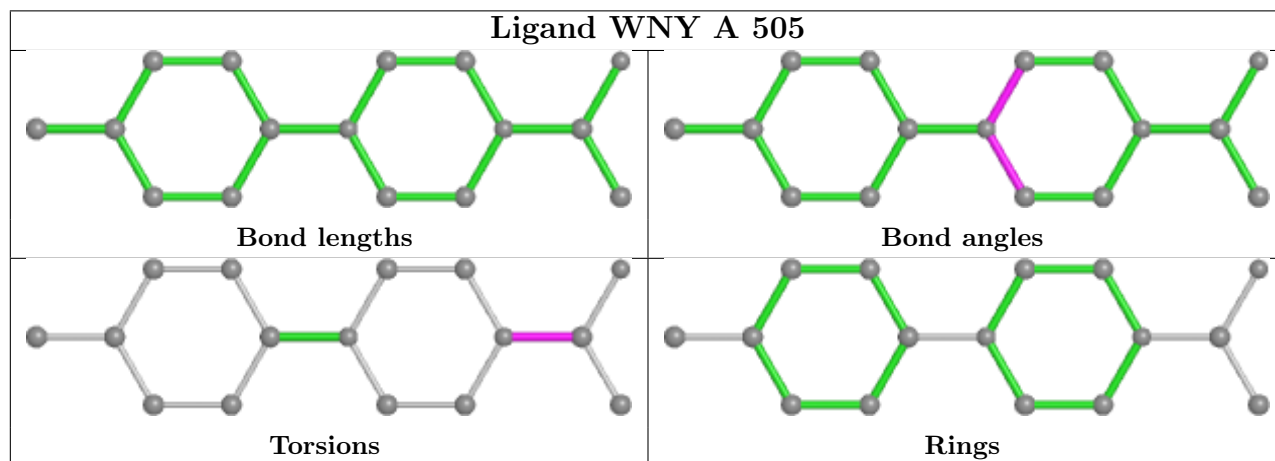
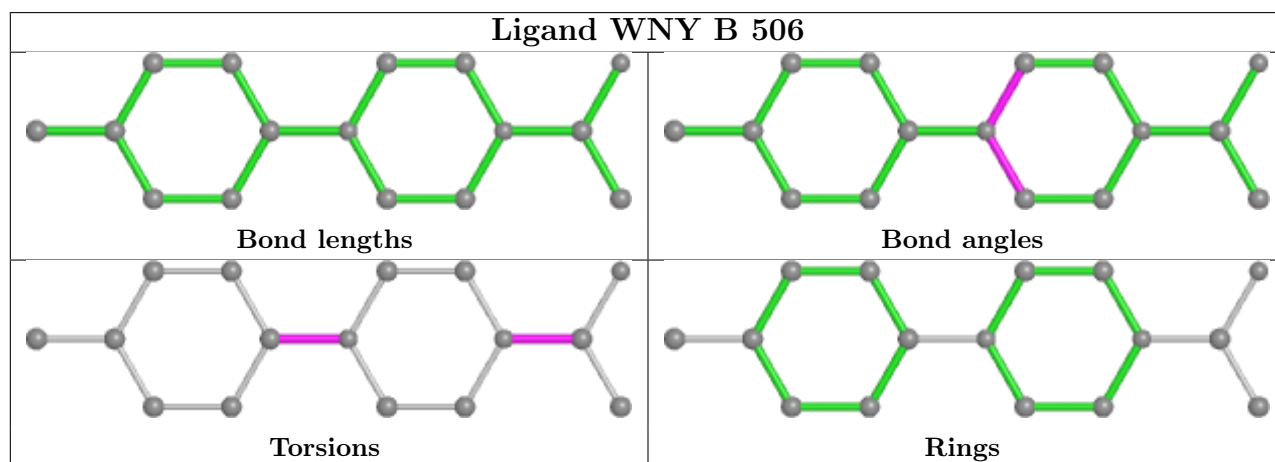
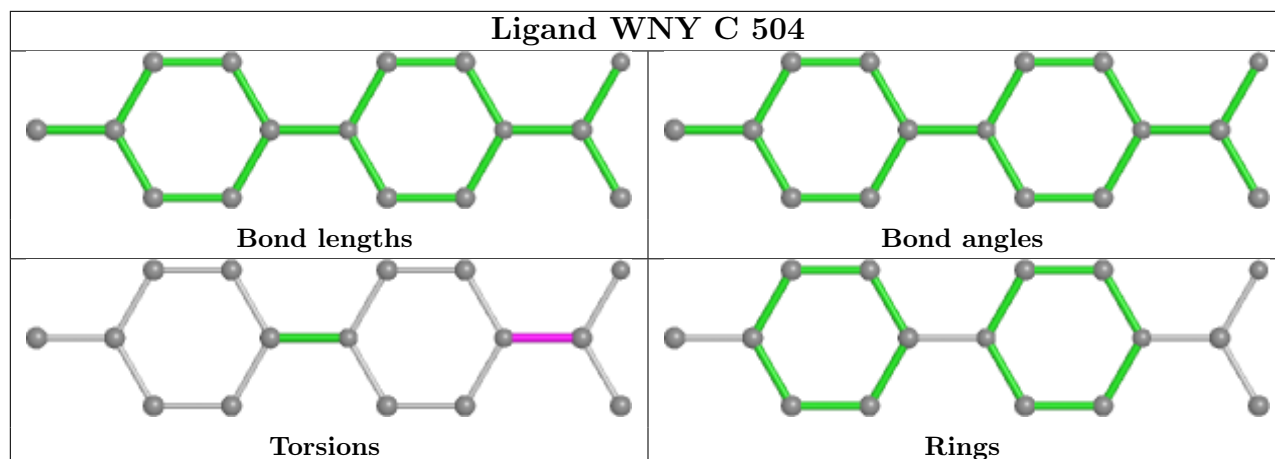

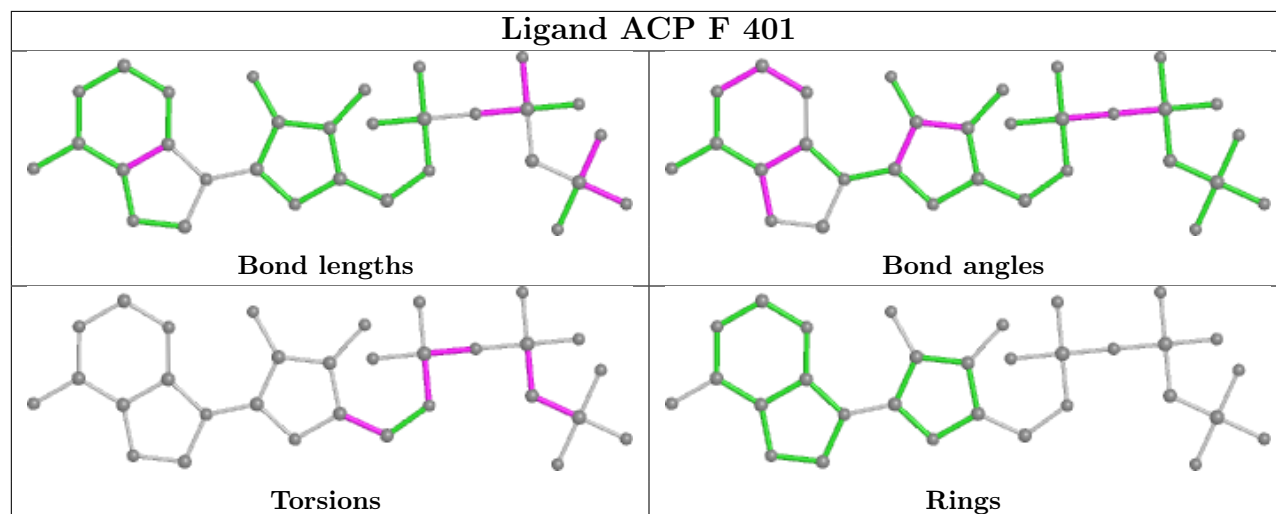
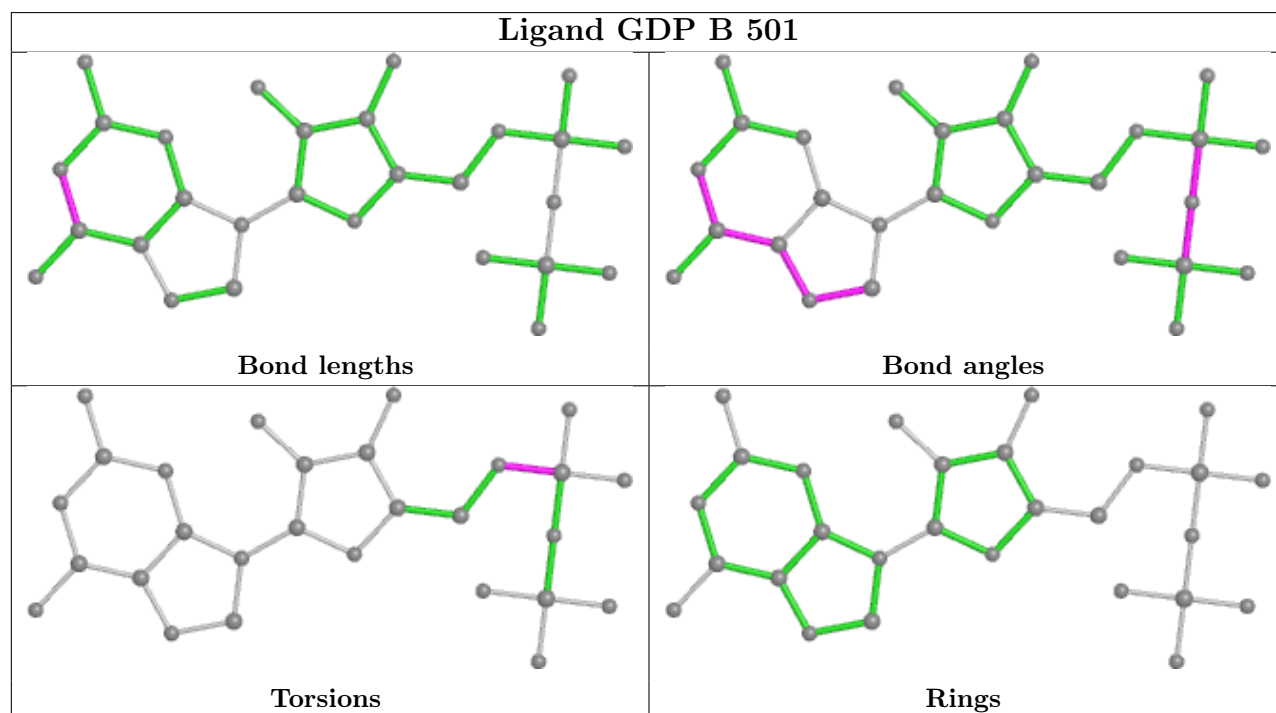
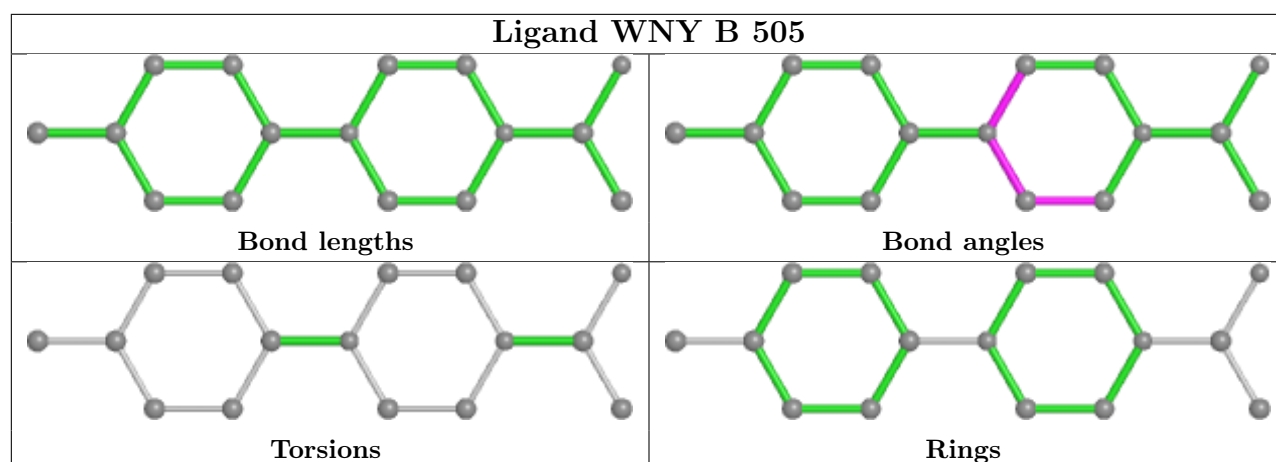

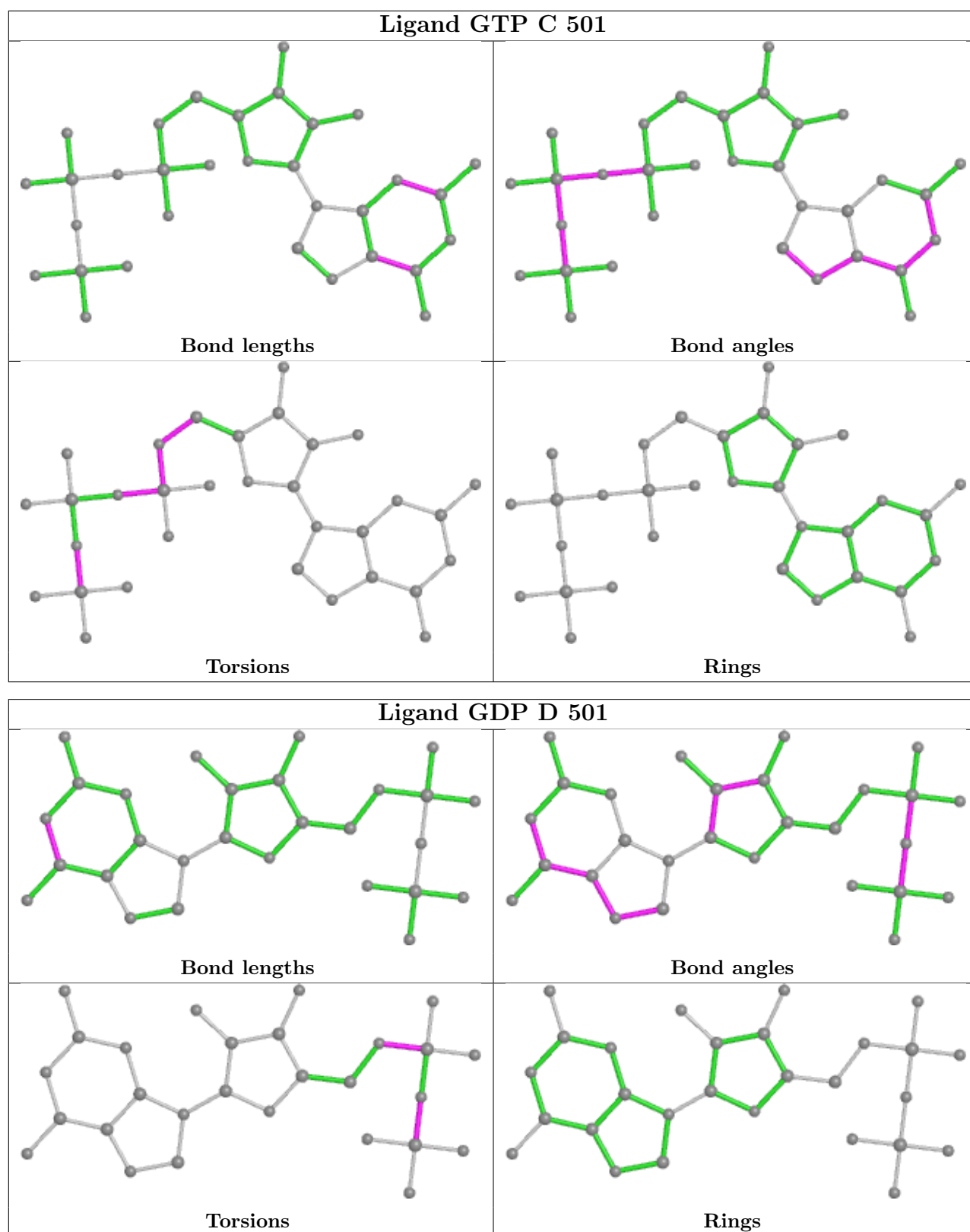

5.7 Other polymers [i](#)

There are no such residues in this entry.

5.8 Polymer linkage issues

There are no chain breaks in this entry.

6 Fit of model and data

6.1 Protein, DNA and RNA chains

In the following table, the column labelled ‘#RSRZ > 2’ contains the number (and percentage) of RSRZ outliers, followed by percent RSRZ outliers for the chain as percentile scores relative to all X-ray entries and entries of similar resolution. The OWAB column contains the minimum, median, 95th percentile and maximum values of the occupancy-weighted average B-factor per residue. The column labelled ‘Q < 0.9’ lists the number of (and percentage) of residues with an average occupancy less than 0.9.

Mol	Chain	Analysed	<RSRZ>	#RSRZ>2	OWAB(Å ²)	Q<0.9
1	A	438/451 (97%)	0.16	12 (2%) 54 62	34, 55, 95, 154	0
1	C	440/451 (97%)	0.25	5 (1%) 80 85	32, 45, 69, 124	0
2	B	422/445 (94%)	0.52	18 (4%) 35 42	33, 55, 101, 145	3 (0%)
2	D	426/445 (95%)	0.25	17 (3%) 38 45	40, 63, 96, 140	4 (0%)
3	E	123/143 (86%)	0.79	8 (6%) 18 24	43, 64, 124, 161	0
4	F	349/384 (90%)	0.96	62 (17%) 1 1	48, 79, 137, 163	0
All	All	2198/2319 (94%)	0.43	122 (5%) 24 30	32, 59, 109, 163	7 (0%)

All (122) RSRZ outliers are listed below:

Mol	Chain	Res	Type	RSRZ
3	E	24	LEU	11.3
4	F	173	ILE	9.9
3	E	26	PRO	9.3
2	B	281	GLN	8.8
3	E	27	PRO	8.7
2	B	284	ARG	8.5
1	A	349	THR	6.8
3	E	28	SER	6.5
4	F	137	ARG	5.8
4	F	371	PRO	5.5
4	F	251	LYS	5.4
4	F	372	THR	5.3
2	B	1	MET	5.1
4	F	244	CYS	4.9
3	E	25	LYS	4.9
4	F	245	ILE	4.9
4	F	253	TYR	4.8
2	D	278	ARG	4.7
4	F	177	GLY	4.5

Continued on next page...

Continued from previous page...

Mol	Chain	Res	Type	RSRZ
2	B	333	LEU	4.5
4	F	152	SER	4.4
2	B	283	TYR	4.4
1	A	339	ARG	4.3
3	E	6	MET	4.2
4	F	231	ALA	4.2
4	F	160	ILE	4.0
2	D	277	SER	4.0
4	F	90	SER	4.0
4	F	233	PHE	4.0
4	F	249	TYR	3.9
4	F	259	GLY	3.9
4	F	240	LEU	3.8
3	E	142	GLU	3.8
4	F	169	LEU	3.8
4	F	248	GLU	3.8
4	F	155	ALA	3.8
4	F	178	GLN	3.7
4	F	89	GLU	3.5
2	D	127	GLU	3.5
4	F	170	LEU	3.4
4	F	182	ILE	3.3
1	A	438	ASP	3.3
2	D	276	THR	3.3
4	F	256	TYR	3.3
4	F	17	VAL	3.3
4	F	142	ARG	3.3
1	A	351	PHE	3.3
4	F	232	ASN	3.2
2	D	1	MET	3.2
4	F	136	ASN	3.2
2	D	57	THR	3.1
2	B	337	ASN	3.1
2	D	404	PHE	3.1
1	A	262	TYR	3.1
4	F	100	ILE	3.0
4	F	172	PHE	3.0
4	F	234	GLN	3.0
2	B	325	MET	2.9
4	F	143	GLU	2.9
4	F	129	GLU	2.9
2	B	303	ALA	2.9

Continued on next page...

Continued from previous page...

Mol	Chain	Res	Type	RSRZ
1	A	346	TRP	2.8
2	B	59	ASN	2.8
2	D	219	LEU	2.8
2	D	94	PHE	2.8
4	F	20	LEU	2.8
2	B	286	LEU	2.8
4	F	161	LEU	2.8
2	B	57	THR	2.8
2	D	401	ARG	2.8
4	F	179	VAL	2.7
4	F	31	ARG	2.7
4	F	132	LEU	2.7
1	C	283	HIS	2.7
4	F	243	HIS	2.7
4	F	139	ARG	2.7
1	A	281	ALA	2.6
2	D	248	LEU	2.6
2	B	285	ALA	2.6
4	F	250	SER	2.6
1	C	179	THR	2.5
1	A	326	LYS	2.5
4	F	254	GLY	2.5
2	B	247	GLN	2.5
1	A	282	TYR	2.5
4	F	149	ALA	2.5
4	F	140	GLU	2.5
1	A	284	GLU	2.4
4	F	168	GLU	2.4
4	F	163	SER	2.4
4	F	186	LEU	2.4
2	B	308	ARG	2.4
4	F	101	TYR	2.4
4	F	134	ALA	2.4
2	D	400	ARG	2.3
4	F	98	TYR	2.3
2	B	340	SER	2.3
1	C	440	VAL	2.3
4	F	199	PHE	2.3
4	F	247	LYS	2.3
4	F	176	GLN	2.3
3	E	122	ARG	2.3
2	B	307	PRO	2.3

Continued on next page...

Continued from previous page...

Mol	Chain	Res	Type	RSRZ
4	F	36	ARG	2.2
2	D	179	ASP	2.2
2	D	83	PHE	2.2
1	A	341	ILE	2.2
1	C	335	ILE	2.2
1	A	335	ILE	2.2
1	C	355	ILE	2.2
4	F	252	ASN	2.2
4	F	125	THR	2.2
2	D	215	ARG	2.1
2	B	293	GLN	2.1
4	F	154	GLY	2.1
2	D	247	GLN	2.1
4	F	376	ILE	2.1
2	B	437	ASP	2.1
2	D	216	THR	2.0
4	F	335	ALA	2.0
4	F	21	LEU	2.0
4	F	153	ALA	2.0

6.2 Non-standard residues in protein, DNA, RNA chains [i](#)

There are no non-standard protein/DNA/RNA residues in this entry.

6.3 Carbohydrates [i](#)

There are no monosaccharides in this entry.

6.4 Ligands [i](#)

In the following table, the Atoms column lists the number of modelled atoms in the group and the number defined in the chemical component dictionary. The B-factors column lists the minimum, median, 95th percentile and maximum values of B factors of atoms in the group. The column labelled 'Q<0.9' lists the number of atoms with occupancy less than 0.9.

Mol	Type	Chain	Res	Atoms	RSCC	RSR	B-factors(Å ²)	Q<0.9
8	WNY	B	506	16/16	0.70	0.30	52,69,76,83	31
8	WNY	A	505	16/16	0.85	0.24	61,82,111,111	31
8	WNY	C	505	16/16	0.85	0.21	46,63,75,82	31
11	ACP	F	401	31/31	0.85	0.14	76,86,93,99	0

Continued on next page...

Continued from previous page...

Mol	Type	Chain	Res	Atoms	RSCC	RSR	B-factors(\AA^2)	Q<0.9
6	MG	D	502	1/1	0.87	0.06	63,63,63,63	0
7	CA	B	503	1/1	0.87	0.14	95,95,95,95	0
8	WNY	B	505	16/16	0.90	0.19	51,60,69,72	31
10	MES	B	504	12/12	0.90	0.15	57,63,77,81	0
8	WNY	C	504	16/16	0.90	0.22	49,64,77,77	31
6	MG	B	502	1/1	0.91	0.18	36,36,36,36	0
7	CA	A	504	1/1	0.91	0.07	84,84,84,84	0
6	MG	F	402	1/1	0.92	0.06	78,78,78,78	0
7	CA	A	503	1/1	0.93	0.09	73,73,73,73	0
9	GDP	D	501	28/28	0.95	0.14	54,59,68,74	0
6	MG	C	502	1/1	0.96	0.14	34,34,34,34	0
5	GTP	C	501	32/32	0.98	0.16	29,35,40,42	0
7	CA	C	503	1/1	0.98	0.15	59,59,59,59	0
6	MG	A	502	1/1	0.99	0.11	32,32,32,32	0
5	GTP	A	501	32/32	0.99	0.15	32,38,41,43	0
9	GDP	B	501	28/28	0.99	0.17	30,42,47,49	0

The following is a graphical depiction of the model fit to experimental electron density of all instances of the Ligand of Interest. In addition, ligands with molecular weight > 250 and outliers as shown on the geometry validation Tables will also be included. Each fit is shown from different orientation to approximate a three-dimensional view.

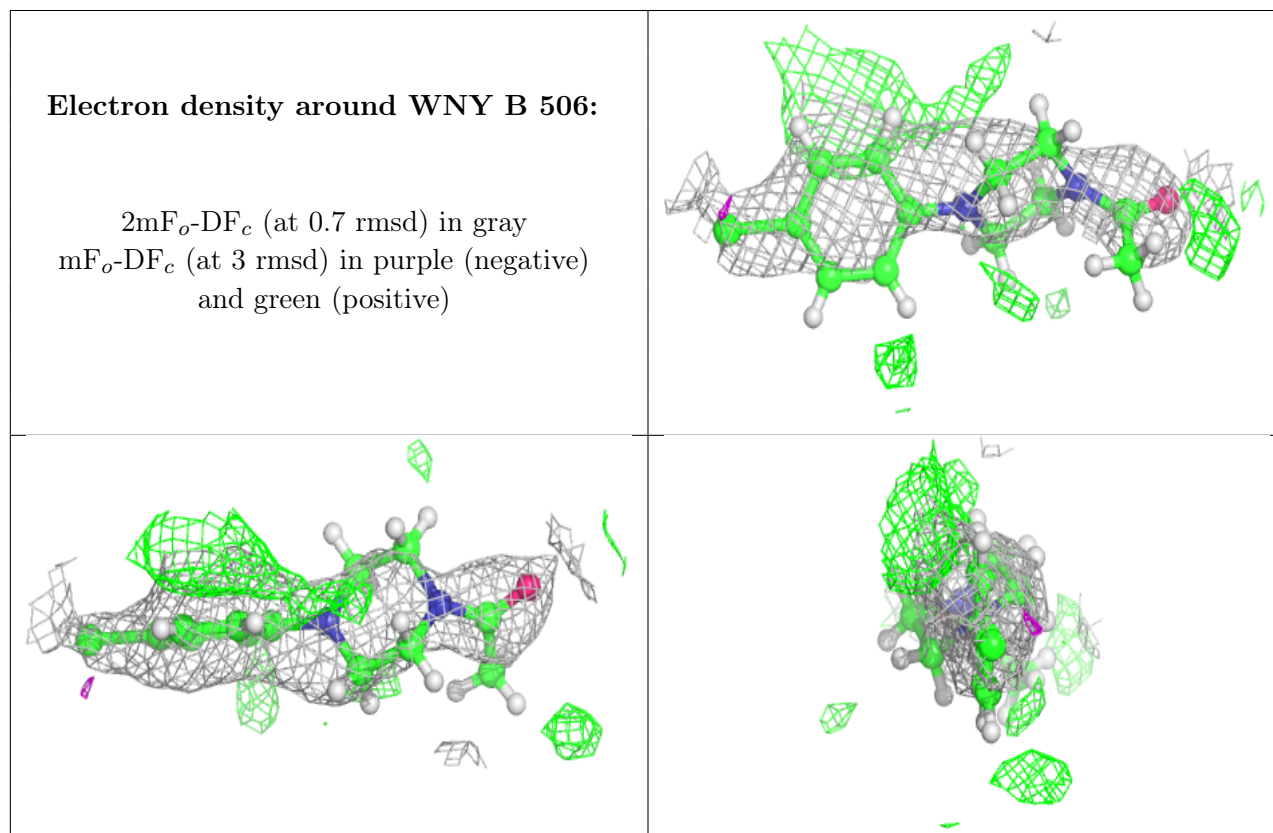

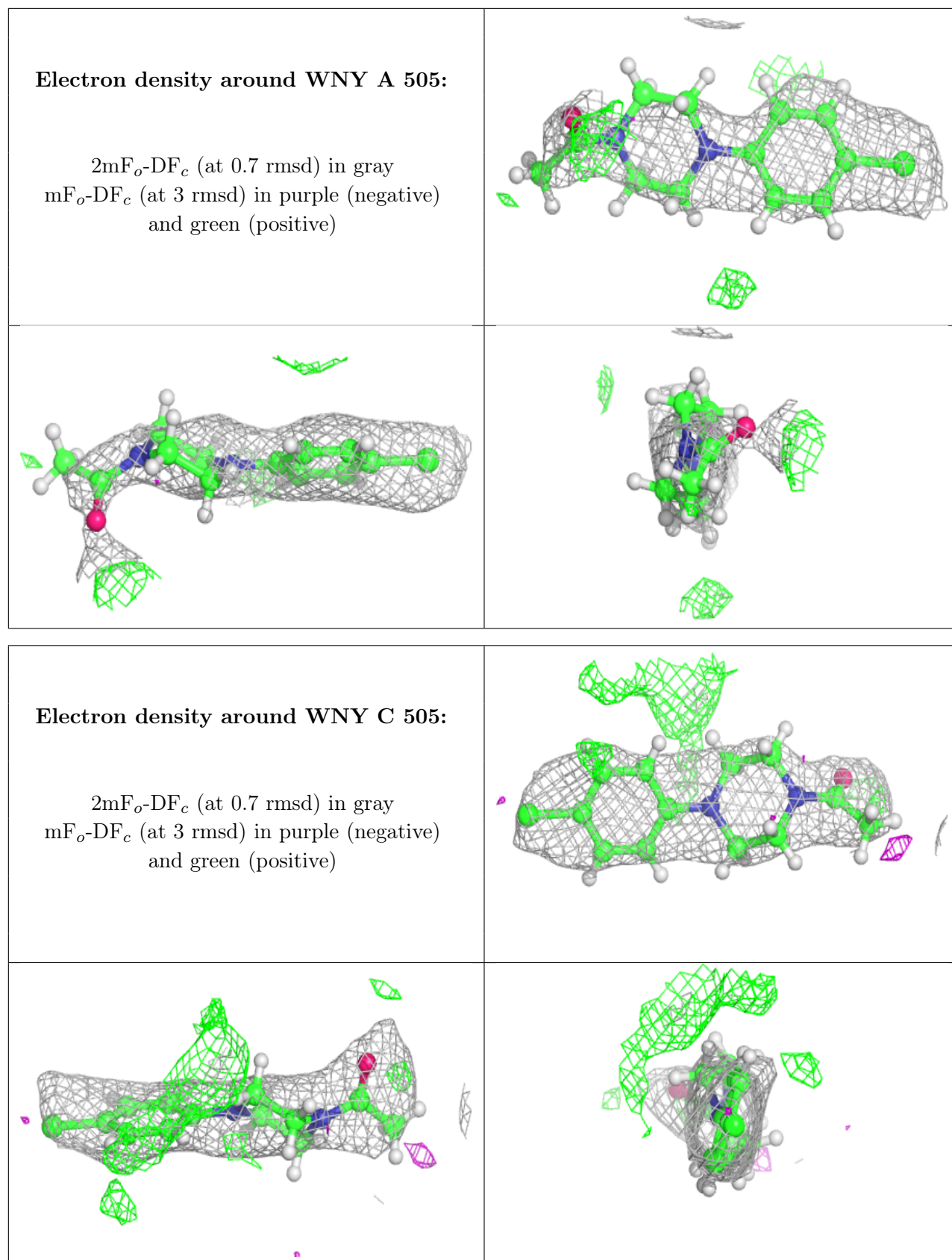

Electron density around ACP F 401:

$2mF_o-DF_c$ (at 0.7 rmsd) in gray
 mF_o-DF_c (at 3 rmsd) in purple (negative)
and green (positive)

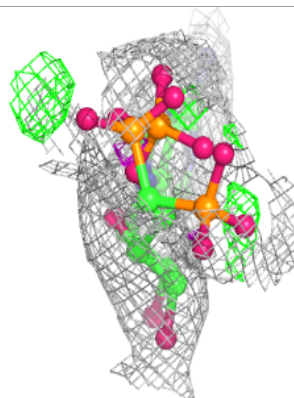
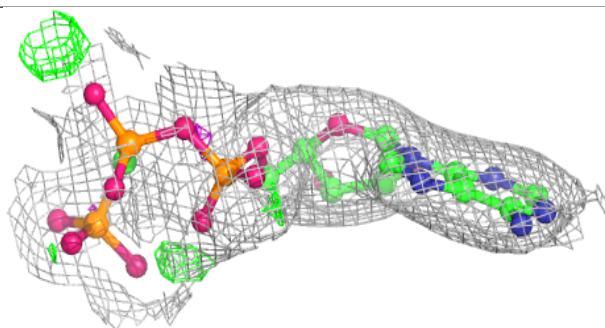
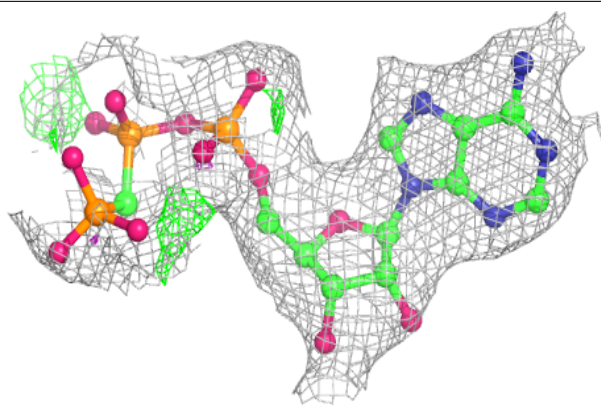
**Electron density around WNY B 505:**

$2mF_o-DF_c$ (at 0.7 rmsd) in gray
 mF_o-DF_c (at 3 rmsd) in purple (negative)
and green (positive)

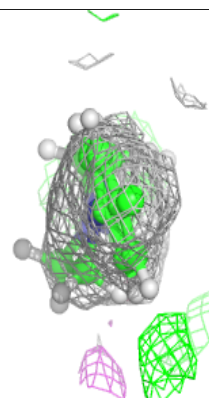
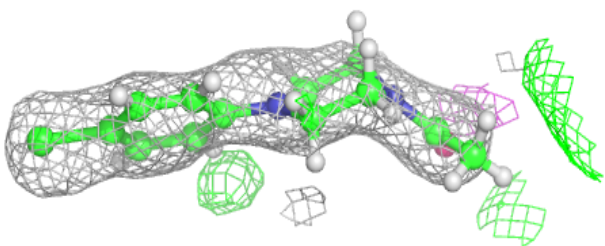
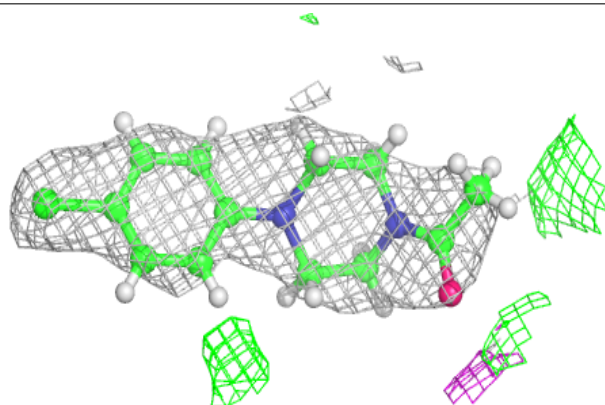

Electron density around WNY C 504:

$2mF_o-DF_c$ (at 0.7 rmsd) in gray
 mF_o-DF_c (at 3 rmsd) in purple (negative)
and green (positive)

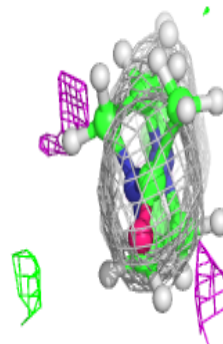
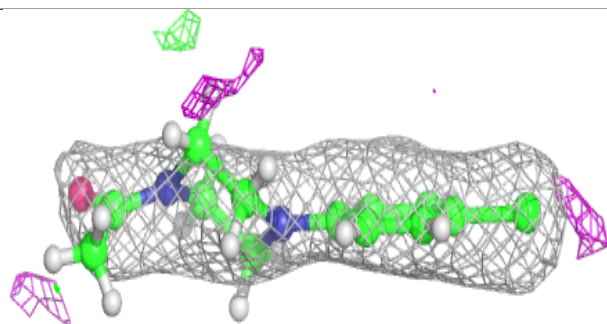
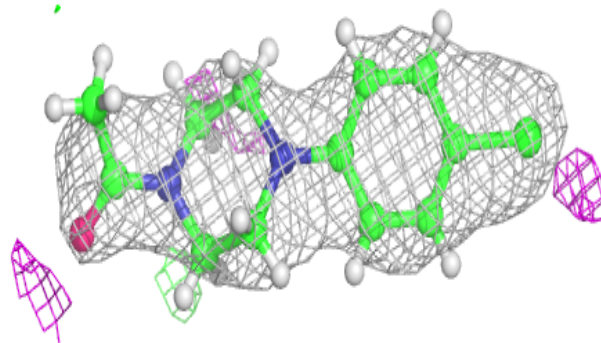
**Electron density around GDP D 501:**

$2mF_o-DF_c$ (at 0.7 rmsd) in gray
 mF_o-DF_c (at 3 rmsd) in purple (negative)
and green (positive)

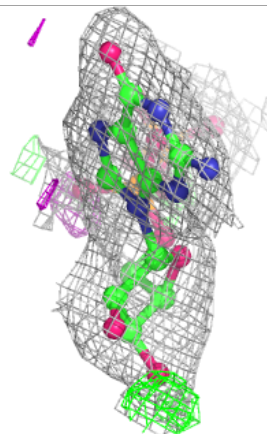
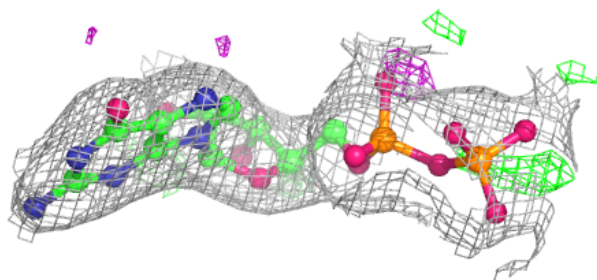
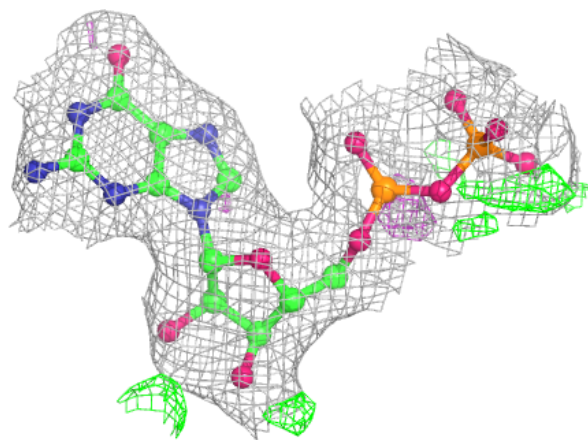

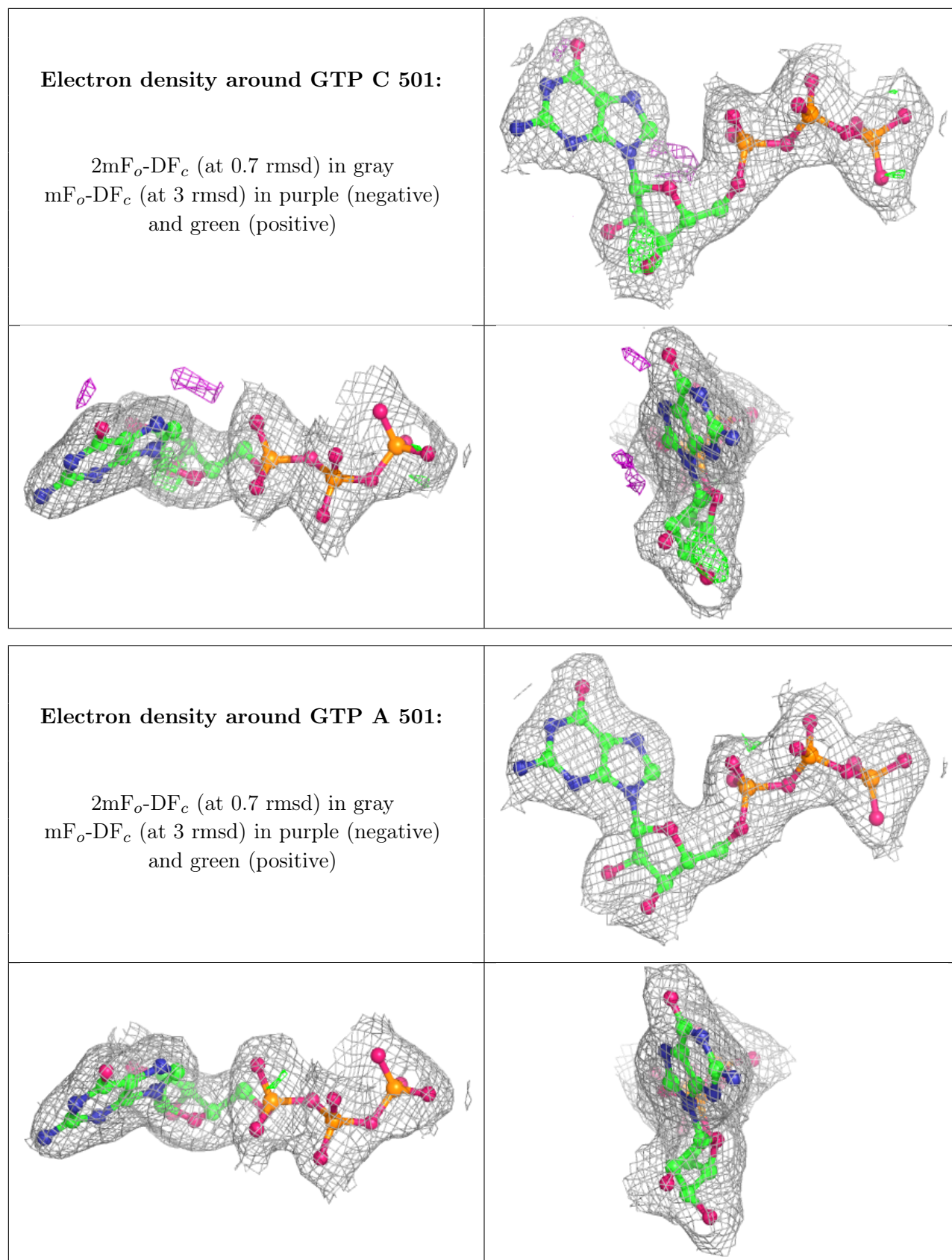

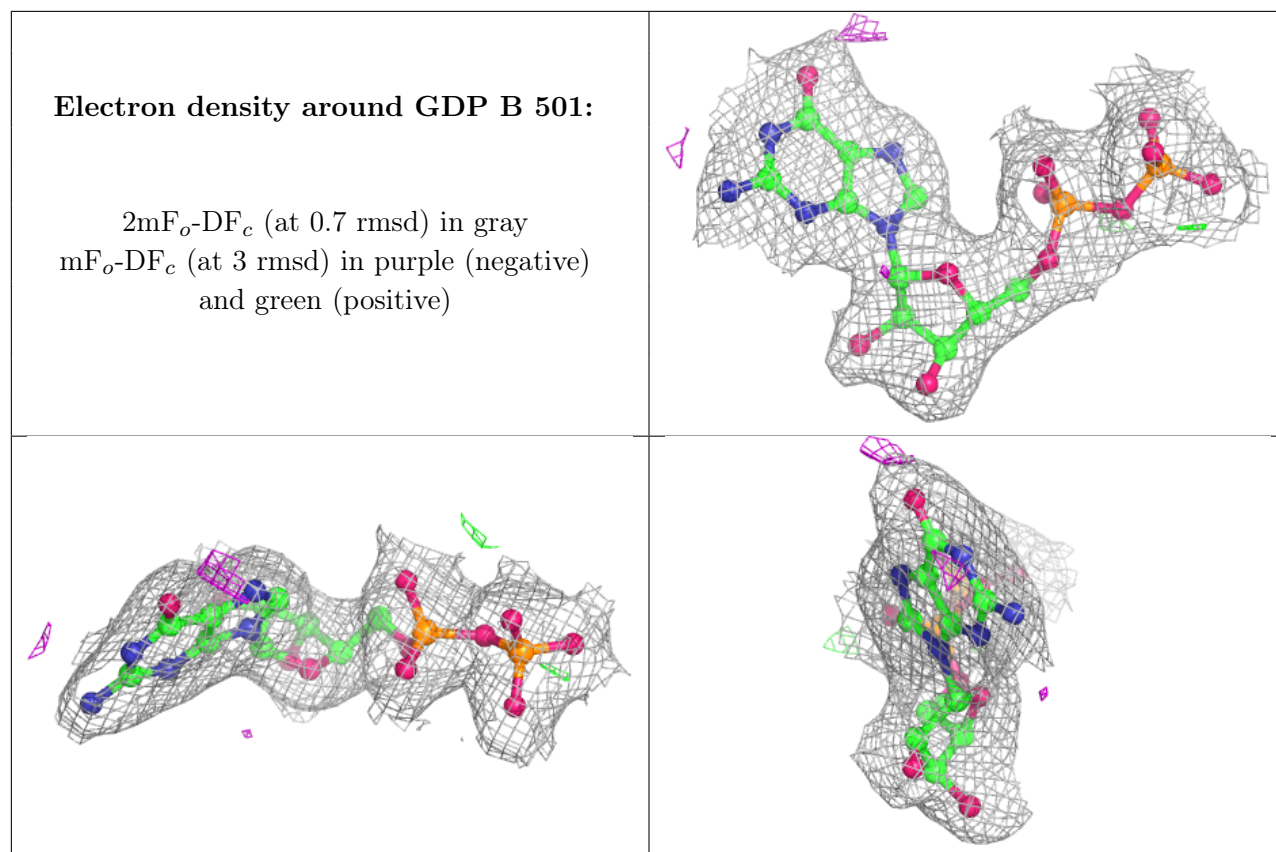

6.5 Other polymers [i](#)

There are no such residues in this entry.