



Full wwPDB X-ray Structure Validation Report ⓘ

May 13, 2020 – 05:46 am BST

PDB ID : 5HIN
Title : Crystal structure of human dihydroorotate dehydrogenase (DHODH) with 18L compound
Authors : Huang, J.; Wu, D.; Lu, Q.; Yao, X.
Deposited on : 2016-01-12
Resolution : 1.60 Å(reported)

This is a Full wwPDB X-ray Structure Validation Report for a publicly released PDB entry.

We welcome your comments at validation@mail.wwpdb.org

A user guide is available at

<https://www.wwpdb.org/validation/2017/XrayValidationReportHelp>

with specific help available everywhere you see the ⓘ symbol.

The following versions of software and data (see [references ⓘ](#)) were used in the production of this report:

MolProbity : 4.02b-467
Mogul : 1.8.5 (274361), CSD as541be (2020)
Xtriage (Phenix) : 1.13
EDS : 2.11
buster-report : 1.1.7 (2018)
Percentile statistics : 20191225.v01 (using entries in the PDB archive December 25th 2019)
Refmac : 5.8.0158
CCP4 : 7.0.044 (Gargrove)
Ideal geometry (proteins) : Engh & Huber (2001)
Ideal geometry (DNA, RNA) : Parkinson et al. (1996)
Validation Pipeline (wwPDB-VP) : 2.11

1 Overall quality at a glance

The following experimental techniques were used to determine the structure:

X-RAY DIFFRACTION

The reported resolution of this entry is 1.60 Å.

Percentile scores (ranging between 0-100) for global validation metrics of the entry are shown in the following graphic. The table shows the number of entries on which the scores are based.

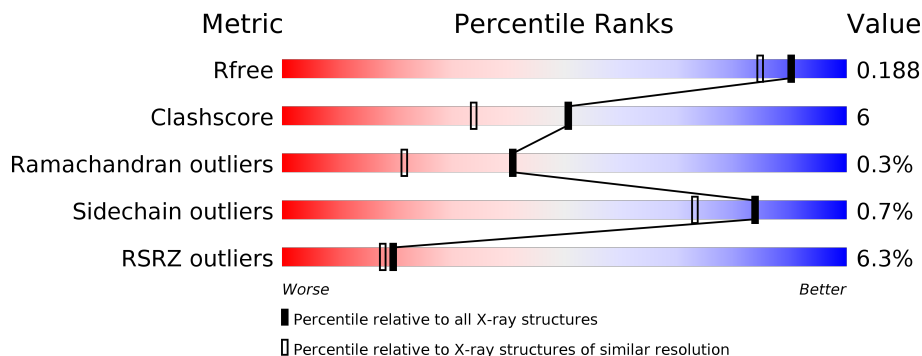

Metric	Whole archive (#Entries)	Similar resolution (#Entries, resolution range(Å))
R_{free}	130704	3398 (1.60-1.60)
Clashscore	141614	3665 (1.60-1.60)
Ramachandran outliers	138981	3564 (1.60-1.60)
Sidechain outliers	138945	3563 (1.60-1.60)
RSRZ outliers	127900	3321 (1.60-1.60)

The table below summarises the geometric issues observed across the polymeric chains and their fit to the electron density. The red, orange, yellow and green segments on the lower bar indicate the fraction of residues that contain outliers for ≥ 3 , 2, 1 and 0 types of geometric quality criteria respectively. A grey segment represents the fraction of residues that are not modelled. The numeric value for each fraction is indicated below the corresponding segment, with a dot representing fractions $\leq 5\%$. The upper red bar (where present) indicates the fraction of residues that have poor fit to the electron density. The numeric value is given above the bar.

Mol	Chain	Length	Quality of chain
1	A	390	

The following table lists non-polymeric compounds, carbohydrate monomers and non-standard residues in protein, DNA, RNA chains that are outliers for geometric or electron-density-fit criteria:

Mol	Type	Chain	Res	Chirality	Geometry	Clashes	Electron density
6	ACT	A	410	-	-	X	-

2 Entry composition

There are 7 unique types of molecules in this entry. The entry contains 3100 atoms, of which 0 are hydrogens and 0 are deuteriums.

In the tables below, the ZeroOcc column contains the number of atoms modelled with zero occupancy, the AltConf column contains the number of residues with at least one atom in alternate conformation and the Trace column contains the number of residues modelled with at most 2 atoms.

- Molecule 1 is a protein called Dihydroorotate dehydrogenase (quinone), mitochondrial.

Mol	Chain	Residues	Atoms					ZeroOcc	AltConf	Trace
			Total	C	N	O	S			
1	A	365	2807	1760	519	524	4	0	3	0

There are 23 discrepancies between the modelled and reference sequences:

Chain	Residue	Modelled	Actual	Comment	Reference
A	7	MET	-	expression tag	UNP Q02127
A	8	GLY	-	expression tag	UNP Q02127
A	9	HIS	-	expression tag	UNP Q02127
A	10	HIS	-	expression tag	UNP Q02127
A	11	HIS	-	expression tag	UNP Q02127
A	12	HIS	-	expression tag	UNP Q02127
A	13	HIS	-	expression tag	UNP Q02127
A	14	HIS	-	expression tag	UNP Q02127
A	15	HIS	-	expression tag	UNP Q02127
A	16	HIS	-	expression tag	UNP Q02127
A	17	HIS	-	expression tag	UNP Q02127
A	18	HIS	-	expression tag	UNP Q02127
A	19	SER	-	expression tag	UNP Q02127
A	20	SER	-	expression tag	UNP Q02127
A	21	GLY	-	expression tag	UNP Q02127
A	22	HIS	-	expression tag	UNP Q02127
A	23	ILE	-	expression tag	UNP Q02127
A	24	ASP	-	expression tag	UNP Q02127
A	25	ASP	-	expression tag	UNP Q02127
A	26	ASP	-	expression tag	UNP Q02127
A	27	ASP	-	expression tag	UNP Q02127
A	28	LYS	-	expression tag	UNP Q02127
A	29	HIS	-	expression tag	UNP Q02127

- Molecule 2 is FLAVIN MONONUCLEOTIDE (three-letter code: FMN) (formula: C₁₇H₂₁N₄O₉P).

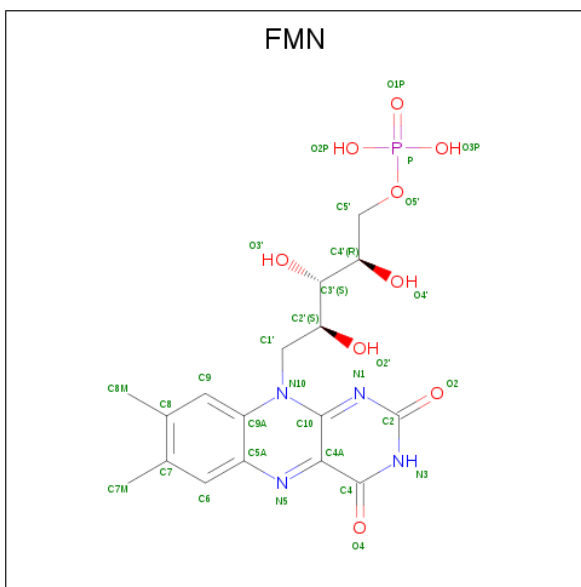

Mol	Chain	Residues	Atoms					ZeroOcc	AltConf
			Total	C	N	O	P		
2	A	1	31	17	4	9	1	0	0

- Molecule 3 is OROTIC ACID (three-letter code: ORO) (formula: $C_5H_4N_2O_4$).

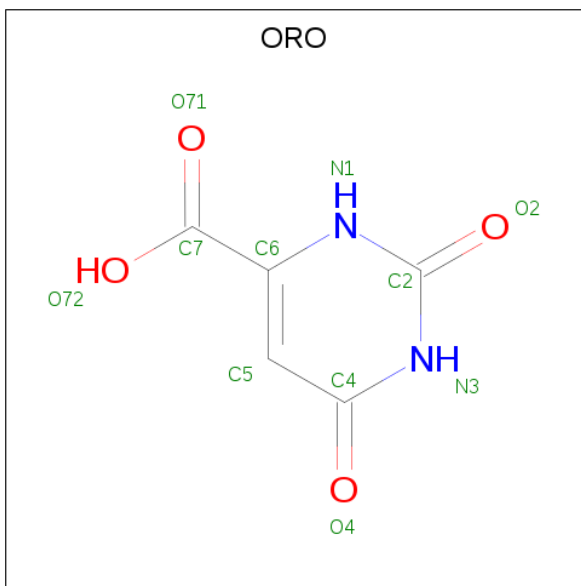

Mol	Chain	Residues	Atoms				ZeroOcc	AltConf
			Total	C	N	O		
3	A	1	11	5	2	4	0	0

- Molecule 4 is SULFATE ION (three-letter code: SO4) (formula: O_4S).



Mol	Chain	Residues	Atoms	ZeroOcc	AltConf
4	A	1	Total O S 5 4 1	0	0
4	A	1	Total O S 5 4 1	0	0
4	A	1	Total O S 5 4 1	0	0
4	A	1	Total O S 5 4 1	0	0
4	A	1	Total O S 5 4 1	0	0

- Molecule 5 is methyl (2Z)-(3-{4-[(4-tert-butylphenyl)carbamoyl]phenyl}-4-oxo-1,3-thiazolidin-2-ylidene)(cyano)acetate (three-letter code: 1KL) (formula: C₂₄H₂₃N₃O₄S).

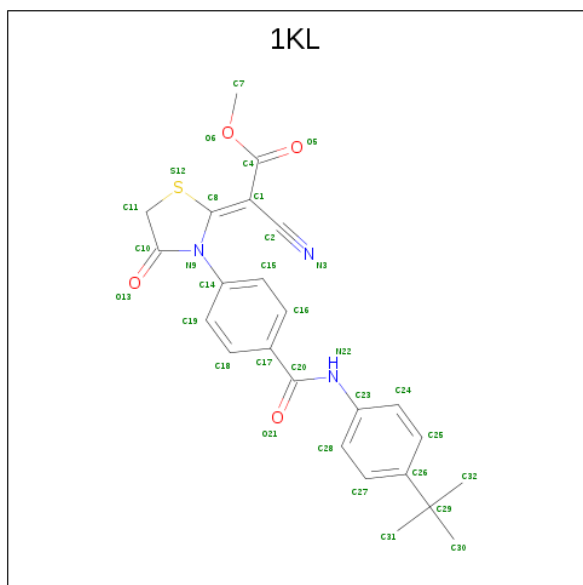

Mol	Chain	Residues	Atoms					ZeroOcc	AltConf
			Total	C	N	O	S		
5	A	1	32	24	3	4	1	0	0

- Molecule 6 is ACETATE ION (three-letter code: ACT) (formula: C₂H₃O₂).

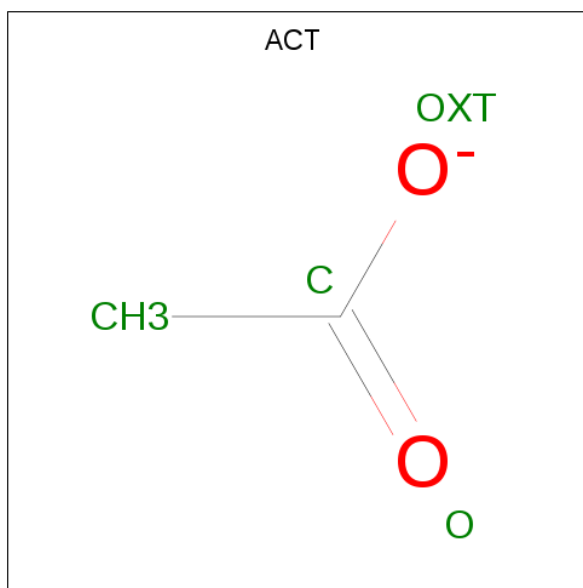

Mol	Chain	Residues	Atoms			ZeroOcc	AltConf
			Total	C	O		
6	A	1	4	2	2	0	0
6	A	1	4	2	2	0	0

- Molecule 7 is water.

Mol	Chain	Residues	Atoms		ZeroOcc	AltConf
7	A	186	Total 186	O 186	0	0

3 Residue-property plots [i](#)

These plots are drawn for all protein, RNA and DNA chains in the entry. The first graphic for a chain summarises the proportions of the various outlier classes displayed in the second graphic. The second graphic shows the sequence view annotated by issues in geometry and electron density. Residues are color-coded according to the number of geometric quality criteria for which they contain at least one outlier: green = 0, yellow = 1, orange = 2 and red = 3 or more. A red dot above a residue indicates a poor fit to the electron density ($RSRZ > 2$). Stretches of 2 or more consecutive residues without any outlier are shown as a green connector. Residues present in the sample, but not in the model, are shown in grey.

- Molecule 1: Dihydroorotate dehydrogenase (quinone), mitochondrial

Chain A: 

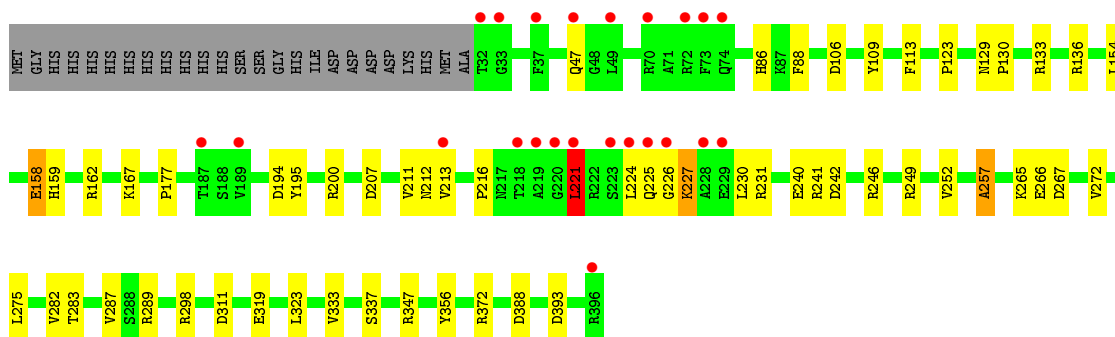

4 Data and refinement statistics

Property	Value	Source
Space group	P 32 2 1	Depositor
Cell constants a, b, c, α , β , γ	90.73Å 90.73Å 122.63Å 90.00° 90.00° 120.00°	Depositor
Resolution (Å)	28.56 – 1.60 28.56 – 1.60	Depositor EDS
% Data completeness (in resolution range)	99.7 (28.56-1.60) 99.7 (28.56-1.60)	Depositor EDS
R_{merge}	(Not available)	Depositor
R_{sym}	(Not available)	Depositor
$\langle I/\sigma(I) \rangle$ ¹	8.97 (at 1.60Å)	Xtrriage
Refinement program	REFMAC 5.7.0032	Depositor
R, R_{free}	0.163 , 0.182 0.168 , 0.188	Depositor DCC
R_{free} test set	2001 reflections (2.60%)	wwPDB-VP
Wilson B-factor (Å ²)	17.3	Xtrriage
Anisotropy	0.013	Xtrriage
Bulk solvent k_{sol} (e/Å ³), B_{sol} (Å ²)	0.42 , 55.1	EDS
L-test for twinning ²	$\langle L \rangle = 0.50$, $\langle L^2 \rangle = 0.33$	Xtrriage
Estimated twinning fraction	0.019 for -h,-k,l	Xtrriage
F_o, F_c correlation	0.96	EDS
Total number of atoms	3100	wwPDB-VP
Average B, all atoms (Å ²)	22.0	wwPDB-VP

Xtrriage's analysis on translational NCS is as follows: *The largest off-origin peak in the Patterson function is 3.51% of the height of the origin peak. No significant pseudotranslation is detected.*

¹Intensities estimated from amplitudes.

²Theoretical values of $\langle |L| \rangle$, $\langle L^2 \rangle$ for acentric reflections are 0.5, 0.333 respectively for untwinned datasets, and 0.375, 0.2 for perfectly twinned datasets.

5 Model quality i

5.1 Standard geometry i

Bond lengths and bond angles in the following residue types are not validated in this section: FMN, ORO, ACT, SO4, 1KL

The Z score for a bond length (or angle) is the number of standard deviations the observed value is removed from the expected value. A bond length (or angle) with $|Z| > 5$ is considered an outlier worth inspection. RMSZ is the root-mean-square of all Z scores of the bond lengths (or angles).

Mol	Chain	Bond lengths		Bond angles	
		RMSZ	# Z >5	RMSZ	# Z >5
1	A	1.38	10/2865 (0.3%)	1.46	34/3870 (0.9%)

Chiral center outliers are detected by calculating the chiral volume of a chiral center and verifying if the center is modelled as a planar moiety or with the opposite hand. A planarity outlier is detected by checking planarity of atoms in a peptide group, atoms in a mainchain group or atoms of a sidechain that are expected to be planar.

Mol	Chain	#Chirality outliers	#Planarity outliers
1	A	0	1

All (10) bond length outliers are listed below:

Mol	Chain	Res	Type	Atoms	Z	Observed(Å)	Ideal(Å)
1	A	337	SER	CB-OG	-7.94	1.31	1.42
1	A	266	GLU	CD-OE2	-6.66	1.18	1.25
1	A	319	GLU	CG-CD	6.11	1.61	1.51
1	A	212	ASN	N-CA	-5.95	1.34	1.46
1	A	257	ALA	N-CA	-5.45	1.35	1.46
1	A	267	ASP	CB-CG	5.35	1.62	1.51
1	A	195	TYR	CZ-OH	5.29	1.46	1.37
1	A	323	LEU	CA-CB	-5.21	1.41	1.53
1	A	133	ARG	NE-CZ	5.02	1.39	1.33
1	A	212	ASN	CG-OD1	-5.01	1.12	1.24

All (34) bond angle outliers are listed below:

Mol	Chain	Res	Type	Atoms	Z	Observed(°)	Ideal(°)
1	A	249	ARG	NE-CZ-NH1	10.14	125.37	120.30
1	A	133	ARG	NE-CZ-NH1	-9.31	115.65	120.30
1	A	227	LYS	N-CA-C	9.06	135.46	111.00

Continued on next page...

Continued from previous page...

Mol	Chain	Res	Type	Atoms	Z	Observed(°)	Ideal(°)
1	A	311	ASP	CB-CG-OD1	8.92	126.33	118.30
1	A	347	ARG	NE-CZ-NH2	-8.28	116.16	120.30
1	A	275	LEU	CB-CG-CD1	7.89	124.42	111.00
1	A	319	GLU	OE1-CD-OE2	-7.43	114.39	123.30
1	A	207	ASP	CB-CG-OD1	-7.11	111.90	118.30
1	A	207	ASP	CB-CG-OD2	6.97	124.57	118.30
1	A	372	ARG	NE-CZ-NH1	-6.76	116.92	120.30
1	A	289	ARG	NE-CZ-NH2	6.72	123.66	120.30
1	A	231	ARG	NE-CZ-NH1	6.72	123.66	120.30
1	A	167	LYS	CD-CE-NZ	-6.66	96.37	111.70
1	A	113	PHE	CB-CG-CD2	6.46	125.33	120.80
1	A	298	ARG	NE-CZ-NH1	-6.35	117.12	120.30
1	A	241	ARG	NE-CZ-NH2	6.33	123.46	120.30
1	A	221	LEU	CB-CG-CD1	6.32	121.75	111.00
1	A	393	ASP	CB-CG-OD1	6.17	123.86	118.30
1	A	109	TYR	CG-CD2-CE2	6.14	126.21	121.30
1	A	252	VAL	CG1-CB-CG2	-5.92	101.42	110.90
1	A	393	ASP	CB-CG-OD2	-5.55	113.30	118.30
1	A	388	ASP	CB-CG-OD1	-5.54	113.32	118.30
1	A	106	ASP	CB-CG-OD2	-5.50	113.35	118.30
1	A	372	ARG	NE-CZ-NH2	5.42	123.01	120.30
1	A	194	ASP	CB-CG-OD1	5.31	123.08	118.30
1	A	246	ARG	NE-CZ-NH1	5.27	122.93	120.30
1	A	333	VAL	CA-CB-CG1	5.25	118.77	110.90
1	A	113	PHE	CB-CG-CD1	-5.24	117.13	120.80
1	A	231	ARG	NE-CZ-NH2	-5.17	117.71	120.30
1	A	319	GLU	CG-CD-OE2	5.13	128.56	118.30
1	A	242	ASP	CB-CG-OD2	-5.13	113.69	118.30
1	A	162	ARG	NE-CZ-NH1	-5.10	117.75	120.30
1	A	272	VAL	CG1-CB-CG2	5.10	119.06	110.90
1	A	158	GLU	OE1-CD-OE2	-5.03	117.26	123.30

There are no chirality outliers.

All (1) planarity outliers are listed below:

Mol	Chain	Res	Type	Group
1	A	158	GLU	Sidechain

5.2 Too-close contacts [\(i\)](#)

In the following table, the Non-H and H(model) columns list the number of non-hydrogen atoms and hydrogen atoms in the chain respectively. The H(added) column lists the number of hydrogen atoms added and optimized by MolProbity. The Clashes column lists the number of clashes within the asymmetric unit, whereas Symm-Clashes lists symmetry related clashes.

Mol	Chain	Non-H	H(model)	H(added)	Clashes	Symm-Clashes
1	A	2807	0	2879	30	0
2	A	31	0	19	0	0
3	A	11	0	3	0	0
4	A	25	0	0	0	0
5	A	32	0	0	3	0
6	A	8	0	6	3	0
7	A	186	0	0	2	0
All	All	3100	0	2907	33	0

The all-atom clashscore is defined as the number of clashes found per 1000 atoms (including hydrogen atoms). The all-atom clashscore for this structure is 6.

All (33) close contacts within the same asymmetric unit are listed below, sorted by their clash magnitude.

Atom-1	Atom-2	Interatomic distance (Å)	Clash overlap (Å)
1:A:47:GLN:HG3	1:A:136:ARG:CZ	1.46	1.41
1:A:47:GLN:HG3	1:A:136:ARG:NH1	1.70	1.06
1:A:47:GLN:CG	1:A:136:ARG:CZ	2.35	1.03
1:A:47:GLN:HG3	1:A:136:ARG:NH2	1.92	0.84
1:A:47:GLN:CG	1:A:136:ARG:NH1	2.45	0.79
1:A:221:LEU:HD23	1:A:224:LEU:HD12	1.68	0.73
1:A:200:ARG:NH1	1:A:240:GLU:OE2	2.23	0.71
1:A:213:VAL:HA	1:A:221:LEU:HD21	1.74	0.69
1:A:226:GLY:O	1:A:230:LEU:HB2	1.96	0.64
5:A:408:1KL:S12	5:A:408:1KL:O5	2.57	0.62
1:A:47:GLN:CD	1:A:136:ARG:NE	2.53	0.62
1:A:159:HIS:HD2	7:A:671:HOH:O	1.82	0.62
1:A:216:PRO:HB3	1:A:287:VAL:CG1	2.33	0.59
1:A:226:GLY:O	1:A:230:LEU:CB	2.52	0.58
1:A:200:ARG:HH11	1:A:240:GLU:CD	2.06	0.58
1:A:200:ARG:NH1	1:A:240:GLU:CD	2.57	0.57
5:A:408:1KL:C14	5:A:408:1KL:C2	2.85	0.54
1:A:211:VAL:HG12	1:A:213:VAL:HG13	1.89	0.54
1:A:225:GLN:HE22	1:A:257:ALA:H	1.56	0.51
1:A:265:LYS:NZ	6:A:410:ACT:CH3	2.74	0.50

Continued on next page...

Continued from previous page...

Atom-1	Atom-2	Interatomic distance (Å)	Clash overlap (Å)
1:A:129:ASN:HB3	1:A:130:PRO:HD2	1.93	0.50
1:A:221:LEU:C	1:A:221:LEU:CD2	2.80	0.50
1:A:86:HIS:HB3	7:A:537:HOH:O	2.14	0.47
1:A:221:LEU:CD2	1:A:221:LEU:O	2.63	0.47
1:A:123:PRO:HA	1:A:154:LEU:HG	1.98	0.46
1:A:265:LYS:NZ	6:A:410:ACT:H1	2.30	0.46
1:A:221:LEU:C	1:A:221:LEU:HD22	2.37	0.45
1:A:47:GLN:CD	1:A:136:ARG:CZ	2.84	0.44
1:A:282:VAL:HA	1:A:283:THR:HA	1.83	0.43
5:A:408:1KL:C15	5:A:408:1KL:C2	2.97	0.43
1:A:47:GLN:OE1	1:A:136:ARG:CD	2.68	0.42
1:A:265:LYS:HZ2	6:A:410:ACT:CH3	2.34	0.40
1:A:88:PHE:CE2	1:A:177:PRO:HG2	2.57	0.40

There are no symmetry-related clashes.

5.3 Torsion angles [i](#)

5.3.1 Protein backbone [i](#)

In the following table, the Percentiles column shows the percent Ramachandran outliers of the chain as a percentile score with respect to all X-ray entries followed by that with respect to entries of similar resolution.

The Analysed column shows the number of residues for which the backbone conformation was analysed, and the total number of residues.

Mol	Chain	Analysed	Favoured	Allowed	Outliers	Percentiles
1	A	367/390 (94%)	354 (96%)	12 (3%)	1 (0%)	41 21

All (1) Ramachandran outliers are listed below:

Mol	Chain	Res	Type
1	A	227	LYS

5.3.2 Protein sidechains [i](#)

In the following table, the Percentiles column shows the percent sidechain outliers of the chain as a percentile score with respect to all X-ray entries followed by that with respect to entries of similar resolution.

The Analysed column shows the number of residues for which the sidechain conformation was analysed, and the total number of residues.

Mol	Chain	Analysed	Rotameric	Outliers	Percentiles
1	A	299/317 (94%)	297 (99%)	2 (1%)	84 73

All (2) residues with a non-rotameric sidechain are listed below:

Mol	Chain	Res	Type
1	A	221	LEU
1	A	356	TYR

Some sidechains can be flipped to improve hydrogen bonding and reduce clashes. All (2) such sidechains are listed below:

Mol	Chain	Res	Type
1	A	159	HIS
1	A	225	GLN

5.3.3 RNA [i](#)

There are no RNA molecules in this entry.

5.4 Non-standard residues in protein, DNA, RNA chains [i](#)

There are no non-standard protein/DNA/RNA residues in this entry.

5.5 Carbohydrates [i](#)

There are no carbohydrates in this entry.

5.6 Ligand geometry [i](#)

10 ligands are modelled in this entry.

In the following table, the Counts columns list the number of bonds (or angles) for which Mogul statistics could be retrieved, the number of bonds (or angles) that are observed in the model and the number of bonds (or angles) that are defined in the Chemical Component Dictionary. The Link column lists molecule types, if any, to which the group is linked. The Z score for a bond length (or angle) is the number of standard deviations the observed value is removed from the expected value. A bond length (or angle) with $|Z| > 2$ is considered an outlier worth inspection. RMSZ is the root-mean-square of all Z scores of the bond lengths (or angles).

Mol	Type	Chain	Res	Link	Bond lengths			Bond angles		
					Counts	RMSZ	# Z > 2	Counts	RMSZ	# Z > 2
4	SO4	A	405	-	4,4,4	0.73	0	6,6,6	0.96	0
6	ACT	A	410	-	1,3,3	3.63	1 (100%)	0,3,3	0.00	-
3	ORO	A	402	-	6,11,11	2.10	2 (33%)	3,15,15	3.77	2 (66%)
6	ACT	A	409	-	1,3,3	0.80	0	0,3,3	0.00	-
4	SO4	A	403	-	4,4,4	0.53	0	6,6,6	0.75	0
4	SO4	A	406	-	4,4,4	0.65	0	6,6,6	0.64	0
5	1KL	A	408	-	33,34,34	2.36	9 (27%)	42,49,49	2.13	10 (23%)
4	SO4	A	404	-	4,4,4	0.35	0	6,6,6	0.54	0
2	FMN	A	401	-	31,33,33	2.02	5 (16%)	40,50,50	2.58	9 (22%)
4	SO4	A	407	-	4,4,4	0.43	0	6,6,6	1.19	1 (16%)

In the following table, the Chirals column lists the number of chiral outliers, the number of chiral centers analysed, the number of these observed in the model and the number defined in the Chemical Component Dictionary. Similar counts are reported in the Torsion and Rings columns. '-' means no outliers of that kind were identified.

Mol	Type	Chain	Res	Link	Chirals	Torsions	Rings
3	ORO	A	402	-	-	0/0/4/4	0/1/1/1
2	FMN	A	401	-	-	5/18/18/18	0/3/3/3
5	1KL	A	408	-	-	1/28/43/43	0/3/3/3

All (17) bond length outliers are listed below:

Mol	Chain	Res	Type	Atoms	Z	Observed(Å)	Ideal(Å)
2	A	401	FMN	C4A-C10	7.45	1.46	1.38
5	A	408	1KL	C2-C1	-6.60	1.30	1.43
5	A	408	1KL	C10-N9	-6.41	1.31	1.40
5	A	408	1KL	C11-S12	-4.08	1.74	1.80
2	A	401	FMN	C4-C4A	4.01	1.48	1.41
6	A	410	ACT	CH3-C	3.63	1.53	1.48
5	A	408	1KL	C11-C10	3.58	1.56	1.50
5	A	408	1KL	C14-N9	3.44	1.49	1.44
3	A	402	ORO	C2-N3	-3.14	1.31	1.38
2	A	401	FMN	C2-N1	-3.08	1.32	1.38
5	A	408	1KL	C2-N3	3.08	1.20	1.14
3	A	402	ORO	C2-N1	-2.92	1.32	1.38
5	A	408	1KL	C23-N22	-2.89	1.35	1.41
5	A	408	1KL	O13-C10	2.82	1.29	1.23
5	A	408	1KL	C8-N9	-2.45	1.34	1.39
2	A	401	FMN	C2-N3	-2.24	1.33	1.38
2	A	401	FMN	C9A-C5A	2.17	1.46	1.42

All (22) bond angle outliers are listed below:

Mol	Chain	Res	Type	Atoms	Z	Observed(°)	Ideal(°)
2	A	401	FMN	C4-N3-C2	9.87	123.47	115.14
5	A	408	1KL	O13-C10-N9	8.72	131.81	124.01
2	A	401	FMN	C4-C4A-C10	-6.96	115.35	119.95
3	A	402	ORO	C5-C4-N3	-5.62	117.52	124.08
2	A	401	FMN	C4A-N5-C5A	4.56	121.33	116.77
2	A	401	FMN	C4-C4A-N5	4.51	123.76	118.60
2	A	401	FMN	C4A-C4-N3	-4.27	117.60	123.43
5	A	408	1KL	C14-N9-C10	-3.85	116.08	123.05
5	A	408	1KL	C24-C25-C26	3.80	126.30	121.22
2	A	401	FMN	C1'-N10-C9A	3.78	121.27	118.29
5	A	408	1KL	C27-C28-C23	3.31	124.12	120.30
5	A	408	1KL	O13-C10-C11	-3.15	116.86	123.54
2	A	401	FMN	C6-C5A-N5	3.11	122.48	119.05
3	A	402	ORO	C4-C5-C6	3.00	118.67	116.73
5	A	408	1KL	C27-C26-C25	-2.96	113.57	117.97
5	A	408	1KL	C25-C26-C29	2.96	127.38	121.58
5	A	408	1KL	O6-C4-C1	2.33	115.81	111.41
2	A	401	FMN	C5A-C9A-N10	2.26	119.35	117.72
2	A	401	FMN	O4'-C4'-C3'	2.13	114.28	109.10
5	A	408	1KL	C28-C23-C24	-2.08	116.18	119.03
4	A	407	SO4	O3-S-O2	-2.08	98.45	109.31
5	A	408	1KL	O21-C20-C17	-2.01	117.35	120.94

There are no chirality outliers.

All (6) torsion outliers are listed below:

Mol	Chain	Res	Type	Atoms
2	A	401	FMN	C2'-C3'-C4'-O4'
2	A	401	FMN	O3'-C3'-C4'-O4'
2	A	401	FMN	O3'-C3'-C4'-C5'
2	A	401	FMN	C2'-C3'-C4'-C5'
2	A	401	FMN	C4'-C5'-O5'-P
5	A	408	1KL	C25-C26-C29-C30

There are no ring outliers.

2 monomers are involved in 6 short contacts:

Mol	Chain	Res	Type	Clashes	Symm-Clashes
6	A	410	ACT	3	0
5	A	408	1KL	3	0

The following is a two-dimensional graphical depiction of Mogul quality analysis of bond lengths, bond angles, torsion angles, and ring geometry for all instances of the Ligand of Interest. In addition, ligands with molecular weight > 250 and outliers as shown on the validation Tables will also be included. For torsion angles, if less than 5% of the Mogul distribution of torsion angles is within 10 degrees of the torsion angle in question, then that torsion angle is considered an outlier. Any bond that is central to one or more torsion angles identified as an outlier by Mogul will be highlighted in the graph. For rings, the root-mean-square deviation (RMSD) between the ring in question and similar rings identified by Mogul is calculated over all ring torsion angles. If the average RMSD is greater than 60 degrees and the minimal RMSD between the ring in question and any Mogul-identified rings is also greater than 60 degrees, then that ring is considered an outlier. The outliers are highlighted in purple. The color gray indicates Mogul did not find sufficient equivalents in the CSD to analyse the geometry.

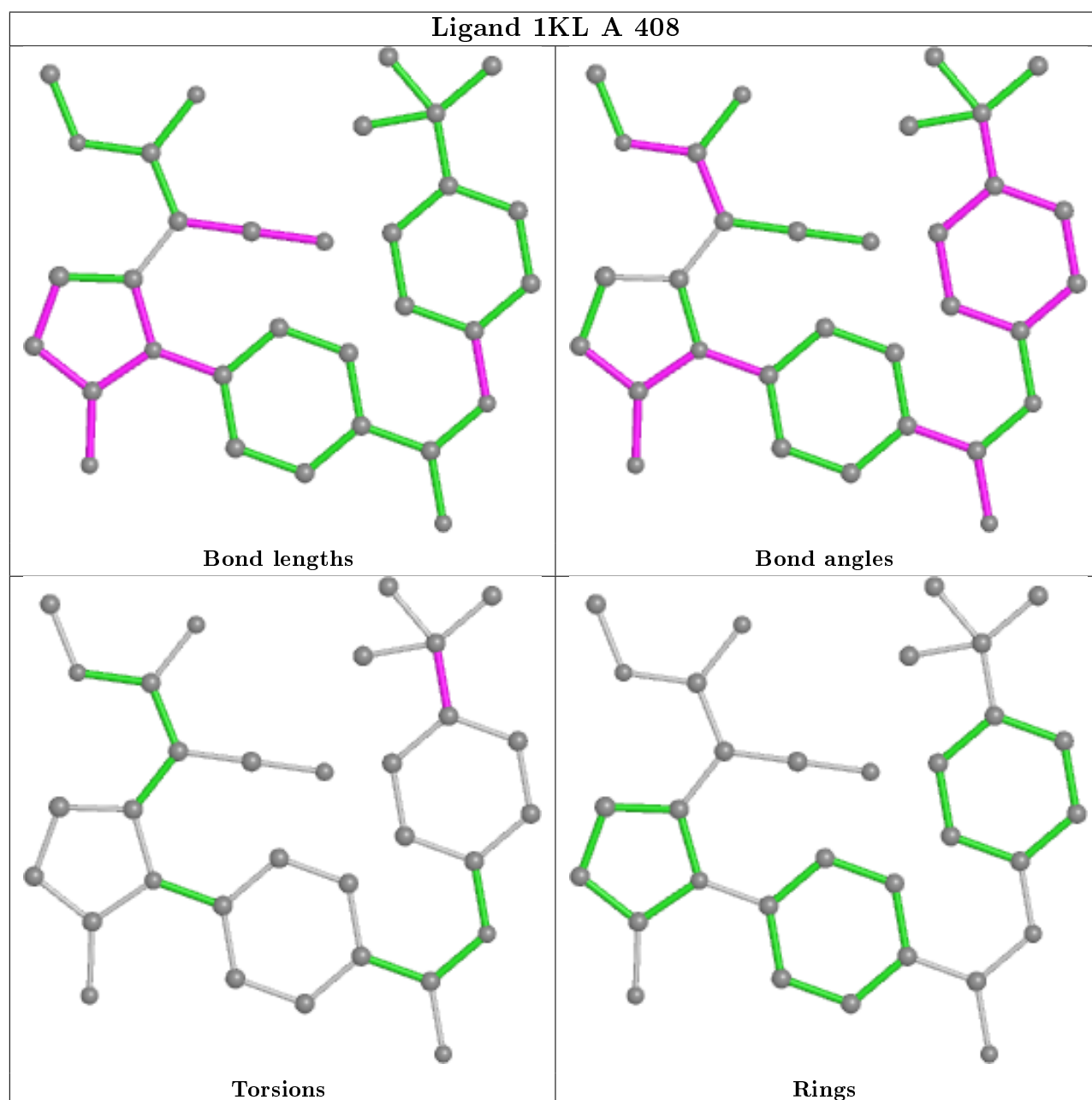

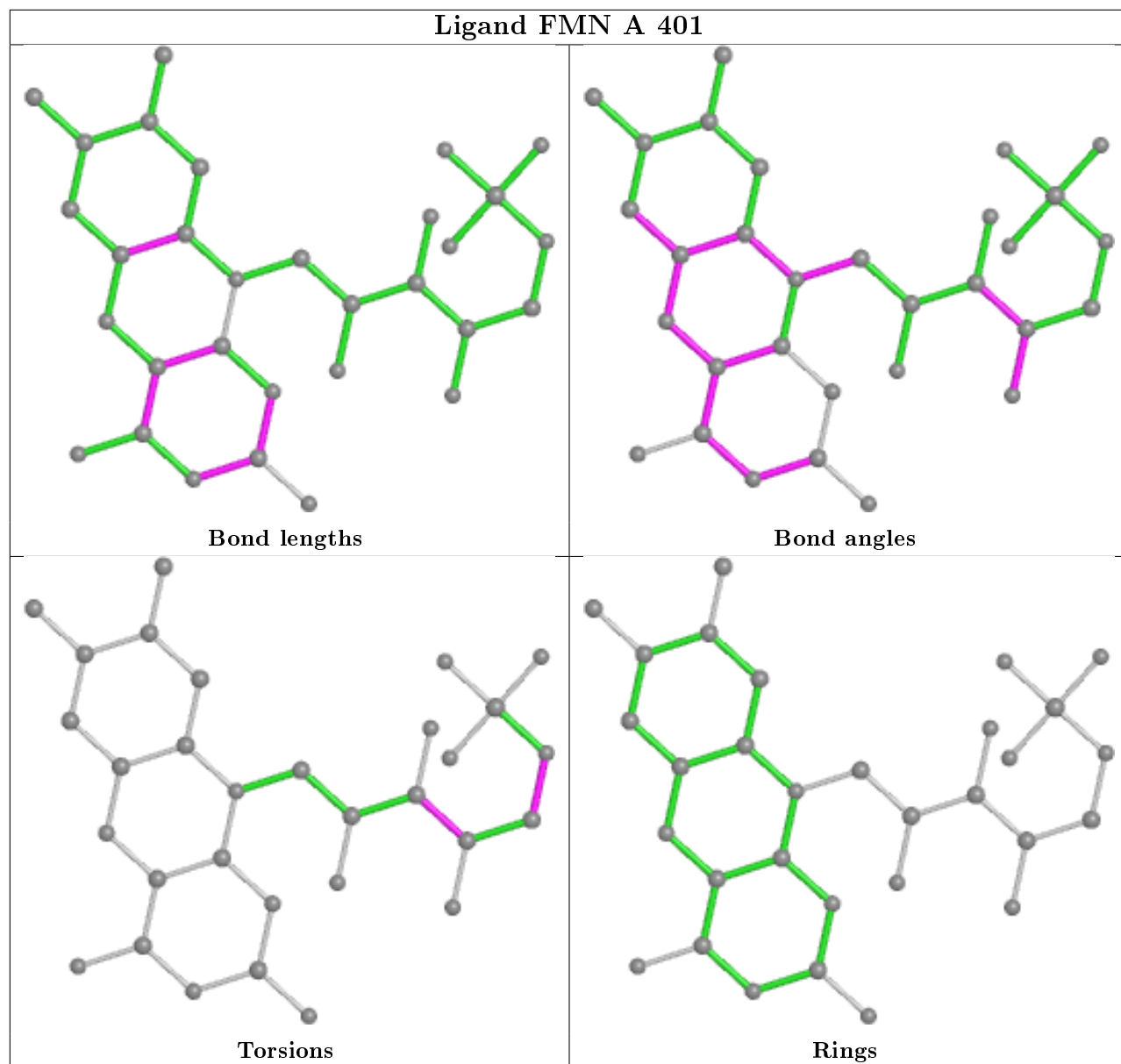

5.7 Other polymers [\(i\)](#)

There are no such residues in this entry.

5.8 Polymer linkage issues [\(i\)](#)

There are no chain breaks in this entry.

6 Fit of model and data

6.1 Protein, DNA and RNA chains

In the following table, the column labelled ‘#RSRZ> 2’ contains the number (and percentage) of RSRZ outliers, followed by percent RSRZ outliers for the chain as percentile scores relative to all X-ray entries and entries of similar resolution. The OWAB column contains the minimum, median, 95th percentile and maximum values of the occupancy-weighted average B-factor per residue. The column labelled ‘Q< 0.9’ lists the number of (and percentage) of residues with an average occupancy less than 0.9.

Mol	Chain	Analysed	<RSRZ>	#RSRZ>2	OWAB(Å ²)	Q<0.9
1	A	365/390 (93%)	-0.02	23 (6%) 20 18	10, 17, 41, 87	5 (1%)

All (23) RSRZ outliers are listed below:

Mol	Chain	Res	Type	RSRZ
1	A	72	ARG	6.2
1	A	219	ALA	5.8
1	A	225	GLN	5.6
1	A	189	VAL	5.5
1	A	70	ARG	5.4
1	A	223	SER	5.2
1	A	224	LEU	5.1
1	A	226	GLY	4.5
1	A	213	VAL	4.2
1	A	74	GLN	4.1
1	A	47	GLN	4.1
1	A	32	THR	3.9
1	A	396	ARG	3.7
1	A	220	GLY	3.4
1	A	218	THR	3.2
1	A	228	ALA	3.1
1	A	49	LEU	2.7
1	A	33	GLY	2.6
1	A	221	LEU	2.5
1	A	73	PHE	2.5
1	A	37	PHE	2.3
1	A	187	THR	2.1
1	A	229	GLU	2.0

6.2 Non-standard residues in protein, DNA, RNA chains [i](#)

There are no non-standard protein/DNA/RNA residues in this entry.

6.3 Carbohydrates [i](#)

There are no carbohydrates in this entry.

6.4 Ligands [i](#)

In the following table, the Atoms column lists the number of modelled atoms in the group and the number defined in the chemical component dictionary. The B-factors column lists the minimum, median, 95th percentile and maximum values of B factors of atoms in the group. The column labelled 'Q< 0.9' lists the number of atoms with occupancy less than 0.9.

Mol	Type	Chain	Res	Atoms	RSCC	RSR	B-factors(\AA^2)	Q<0.9
6	ACT	A	409	4/4	0.70	0.18	45,50,51,65	0
6	ACT	A	410	4/4	0.77	0.20	23,31,32,38	0
4	SO4	A	406	5/5	0.90	0.32	41,70,73,75	0
4	SO4	A	405	5/5	0.93	0.28	33,50,56,58	0
4	SO4	A	404	5/5	0.93	0.32	63,71,80,92	0
5	1KL	A	408	32/32	0.94	0.08	16,20,31,35	0
4	SO4	A	407	5/5	0.94	0.27	53,62,65,72	0
2	FMN	A	401	31/31	0.97	0.09	8,10,12,13	0
3	ORO	A	402	11/11	0.97	0.07	11,11,15,15	0
4	SO4	A	403	5/5	0.99	0.10	26,26,34,37	0

The following is a graphical depiction of the model fit to experimental electron density of all instances of the Ligand of Interest. In addition, ligands with molecular weight > 250 and outliers as shown on the geometry validation Tables will also be included. Each fit is shown from different orientation to approximate a three-dimensional view.

Electron density around 1KL A 408:

$2mF_o-DF_c$ (at 0.7 rmsd) in gray
 mF_o-DF_c (at 3 rmsd) in purple (negative)
and green (positive)

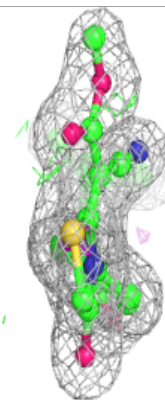
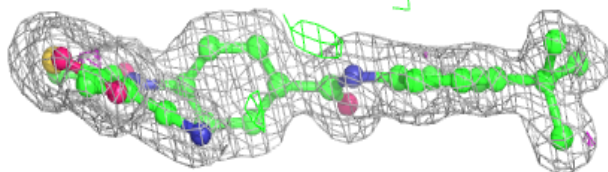
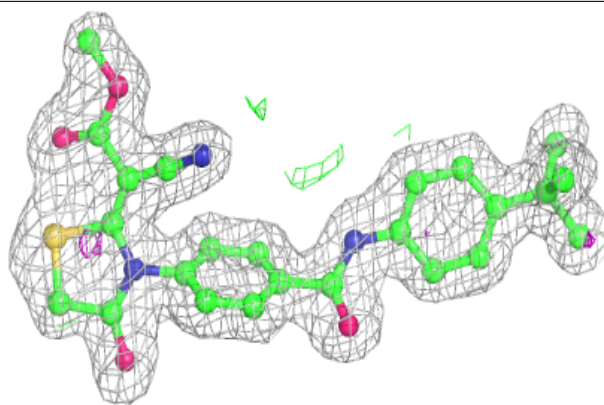
**Electron density around FMN A 401:**

$2mF_o-DF_c$ (at 0.7 rmsd) in gray
 mF_o-DF_c (at 3 rmsd) in purple (negative)
and green (positive)

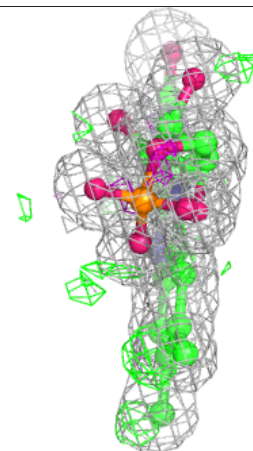
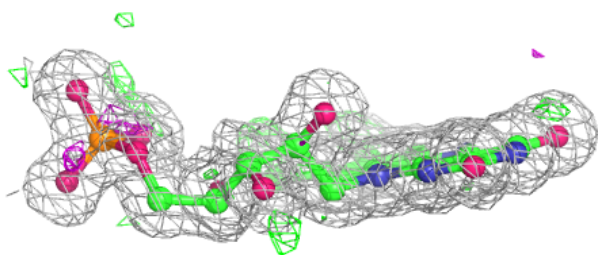
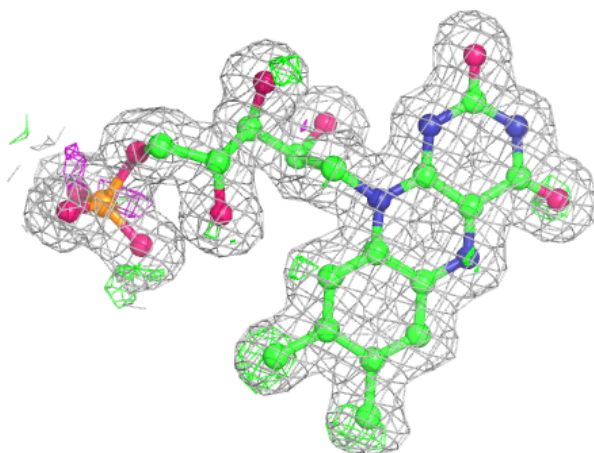

6.5 Other polymers

There are no such residues in this entry.