



Full wwPDB X-ray Structure Validation Report ⓘ

May 13, 2020 – 03:16 am BST

PDB ID : 4YLF
Title : Insights into flavin-based electron bifurcation via the NADH-dependent reduced ferredoxin-NADP oxidoreductase structure
Authors : Ermler, U.; Thauer, R.K.; Demmer, J.K.; Huang, H.; Wang, S.; Demmer, U.
Deposited on : 2015-03-05
Resolution : 2.30 Å(reported)

This is a Full wwPDB X-ray Structure Validation Report for a publicly released PDB entry.

We welcome your comments at validation@mail.wwpdb.org

A user guide is available at

<https://www.wwpdb.org/validation/2017/XrayValidationReportHelp>

with specific help available everywhere you see the ⓘ symbol.

The following versions of software and data (see [references ⓘ](#)) were used in the production of this report:

MolProbity : 4.02b-467
Mogul : 1.8.5 (274361), CSD as541be (2020)
Xtriage (Phenix) : 1.13
EDS : 2.11
buster-report : 1.1.7 (2018)
Percentile statistics : 20191225.v01 (using entries in the PDB archive December 25th 2019)
Refmac : 5.8.0158
CCP4 : 7.0.044 (Gargrove)
Ideal geometry (proteins) : Engh & Huber (2001)
Ideal geometry (DNA, RNA) : Parkinson et al. (1996)
Validation Pipeline (wwPDB-VP) : 2.11

1 Overall quality at a glance i

The following experimental techniques were used to determine the structure:

X-RAY DIFFRACTION

The reported resolution of this entry is 2.30 Å.

Percentile scores (ranging between 0-100) for global validation metrics of the entry are shown in the following graphic. The table shows the number of entries on which the scores are based.

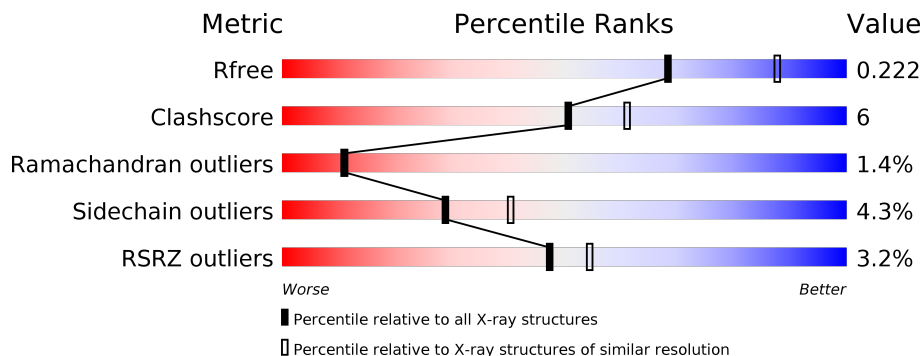

Metric	Whole archive (#Entries)	Similar resolution (#Entries, resolution range(Å))
R_{free}	130704	5042 (2.30-2.30)
Clashscore	141614	5643 (2.30-2.30)
Ramachandran outliers	138981	5575 (2.30-2.30)
Sidechain outliers	138945	5575 (2.30-2.30)
RSRZ outliers	127900	4938 (2.30-2.30)

The table below summarises the geometric issues observed across the polymeric chains and their fit to the electron density. The red, orange, yellow and green segments on the lower bar indicate the fraction of residues that contain outliers for ≥ 3 , 2, 1 and 0 types of geometric quality criteria respectively. A grey segment represents the fraction of residues that are not modelled. The numeric value for each fraction is indicated below the corresponding segment, with a dot representing fractions $\leq 5\%$. The upper red bar (where present) indicates the fraction of residues that have poor fit to the electron density. The numeric value is given above the bar.

Mol	Chain	Length	Quality of chain
1	A	276	<div style="display: flex; align-items: center;"> <div style="width: 4%; height: 10px; background-color: red; margin-right: 5px;"></div> <div style="width: 82%; height: 10px; background-color: green; margin-right: 5px;"></div> <div style="width: 17%; height: 10px; background-color: yellow; margin-right: 5px;"></div> <div style="width: 0.5%; height: 10px; background-color: grey; margin-right: 5px;"></div> <div style="width: 0.5%; height: 10px; background-color: red; margin-right: 5px;"></div> </div> <p style="margin-left: 40px;">82% 17% •</p>
1	C	276	<div style="display: flex; align-items: center;"> <div style="width: 8%; height: 10px; background-color: red; margin-right: 5px;"></div> <div style="width: 73%; height: 10px; background-color: green; margin-right: 5px;"></div> <div style="width: 20%; height: 10px; background-color: yellow; margin-right: 5px;"></div> <div style="width: 5%; height: 10px; background-color: grey; margin-right: 5px;"></div> <div style="width: 0.5%; height: 10px; background-color: red; margin-right: 5px;"></div> </div> <p style="margin-left: 40px;">73% 20% • 5%</p>
2	B	468	<div style="display: flex; align-items: center;"> <div style="width: 2%; height: 10px; background-color: red; margin-right: 5px;"></div> <div style="width: 86%; height: 10px; background-color: green; margin-right: 5px;"></div> <div style="width: 14%; height: 10px; background-color: yellow; margin-right: 5px;"></div> </div> <p style="margin-left: 40px;">86% 14%</p>
2	D	468	<div style="display: flex; align-items: center;"> <div style="width: 0.5%; height: 10px; background-color: red; margin-right: 5px;"></div> <div style="width: 87%; height: 10px; background-color: green; margin-right: 5px;"></div> <div style="width: 12%; height: 10px; background-color: yellow; margin-right: 5px;"></div> </div> <p style="margin-left: 40px;">87% 12% •</p>

2 Entry composition [i](#)

There are 7 unique types of molecules in this entry. The entry contains 11843 atoms, of which 0 are hydrogens and 0 are deuteriums.

In the tables below, the ZeroOcc column contains the number of atoms modelled with zero occupancy, the AltConf column contains the number of residues with at least one atom in alternate conformation and the Trace column contains the number of residues modelled with at most 2 atoms.

- Molecule 1 is a protein called Dihydroorotate dehydrogenase B (NAD(+)), electron transfer subunit homolog.

Mol	Chain	Residues	Atoms					ZeroOcc	AltConf	Trace
			Total	C	N	O	S			
1	A	276	Total 2140	C 1369	N 359	O 398	S 14	0	0	0
1	C	263	Total 2031	C 1301	N 339	O 378	S 13	0	0	0

- Molecule 2 is a protein called Dihydropyrimidine dehydrogenase subunit A.

Mol	Chain	Residues	Atoms					ZeroOcc	AltConf	Trace
			Total	C	N	O	S			
2	B	468	Total 3625	C 2295	N 636	O 673	S 21	0	0	0
2	D	468	Total 3625	C 2295	N 636	O 673	S 21	0	0	0

- Molecule 3 is FE2/S2 (INORGANIC) CLUSTER (three-letter code: FES) (formula: Fe₂S₂).

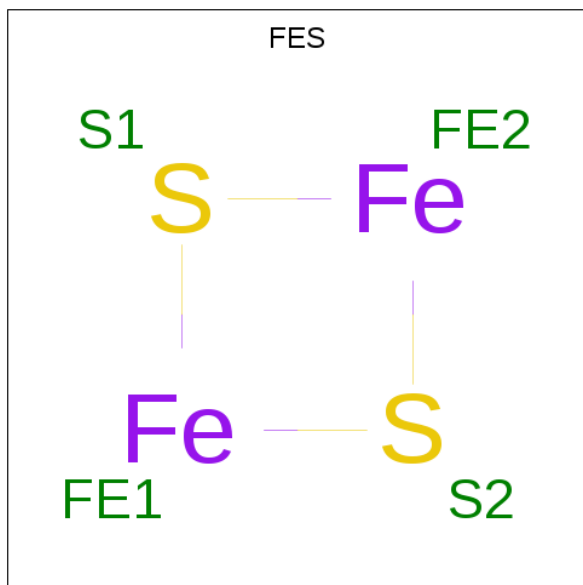

Mol	Chain	Residues	Atoms	ZeroOcc	AltConf
3	A	1	Total Fe S 4 2 2	0	0
3	C	1	Total Fe S 4 2 2	0	0

- Molecule 4 is FLAVIN-ADENINE DINUCLEOTIDE (three-letter code: FAD) (formula: $C_{27}H_{33}N_9O_{15}P_2$).

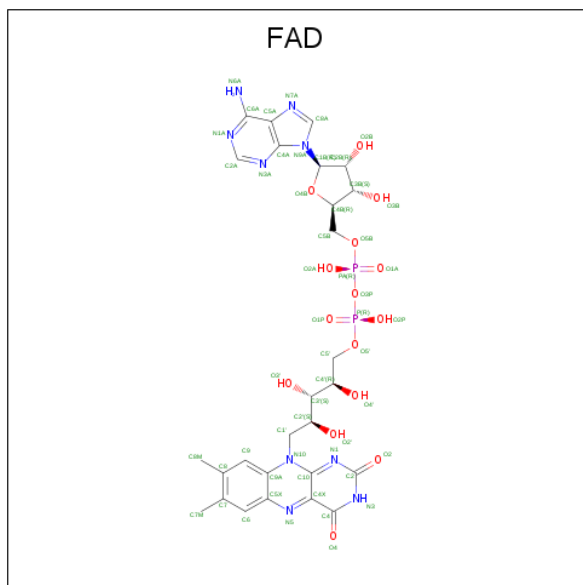

Mol	Chain	Residues	Atoms	ZeroOcc	AltConf
4	A	1	Total C N O P 53 27 9 15 2	0	0
4	B	1	Total C N O P 53 27 9 15 2	0	0
4	C	1	Total C N O P 53 27 9 15 2	0	0
4	D	1	Total C N O P 53 27 9 15 2	0	0

- Molecule 5 is IRON/SULFUR CLUSTER (three-letter code: SF4) (formula: Fe_4S_4).

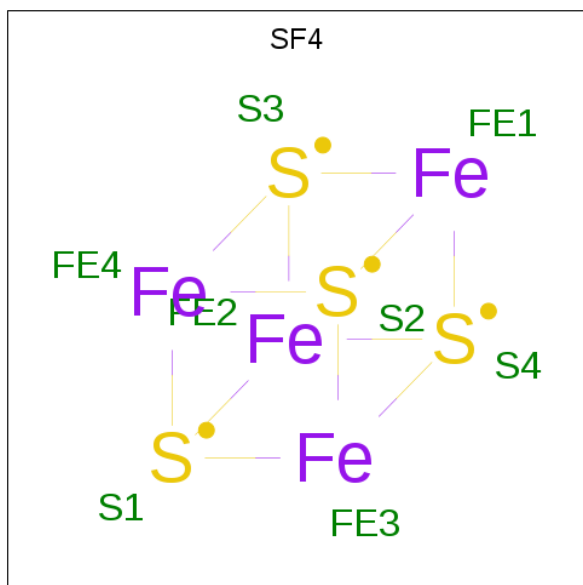

Mol	Chain	Residues	Atoms		ZeroOcc	AltConf
5	B	1	Total	Fe S	0	0
			8	4 4		
5	B	1	Total	Fe S	0	0
			8	4 4		
5	D	1	Total	Fe S	0	0
			8	4 4		
5	D	1	Total	Fe S	0	0
			8	4 4		

- Molecule 6 is PHOSPHATE ION (three-letter code: PO4) (formula: O₄P).

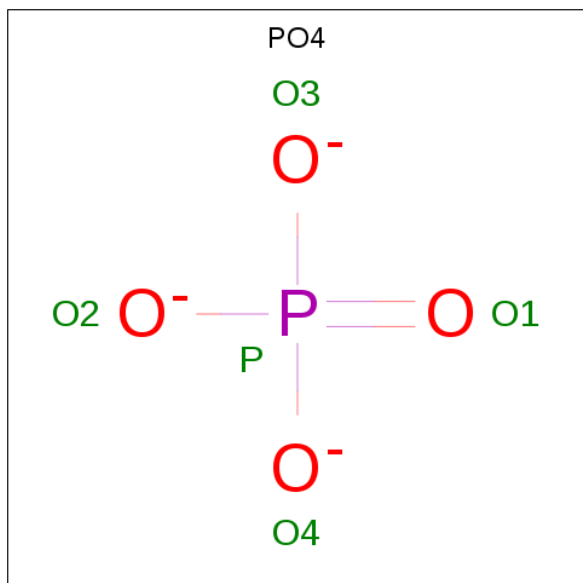

Mol	Chain	Residues	Atoms			ZeroOcc	AltConf
6	B	1	Total	O	P	0	0
			5	4	1		
6	D	1	Total	O	P	0	0
			5	4	1		

- Molecule 7 is water.

Mol	Chain	Residues	Atoms		ZeroOcc	AltConf
7	A	21	Total	O	0	0
			21	21		
7	B	58	Total	O	0	0
			58	58		
7	C	18	Total	O	0	0
			18	18		
7	D	63	Total	O	0	0
			63	63		

3 Residue-property plots [i](#)

These plots are drawn for all protein, RNA and DNA chains in the entry. The first graphic for a chain summarises the proportions of the various outlier classes displayed in the second graphic. The second graphic shows the sequence view annotated by issues in geometry and electron density. Residues are color-coded according to the number of geometric quality criteria for which they contain at least one outlier: green = 0, yellow = 1, orange = 2 and red = 3 or more. A red dot above a residue indicates a poor fit to the electron density ($RSRZ > 2$). Stretches of 2 or more consecutive residues without any outlier are shown as a green connector. Residues present in the sample, but not in the model, are shown in grey.

- Molecule 1: Dihydroorotate dehydrogenase B (NAD(+)), electron transfer subunit homolog

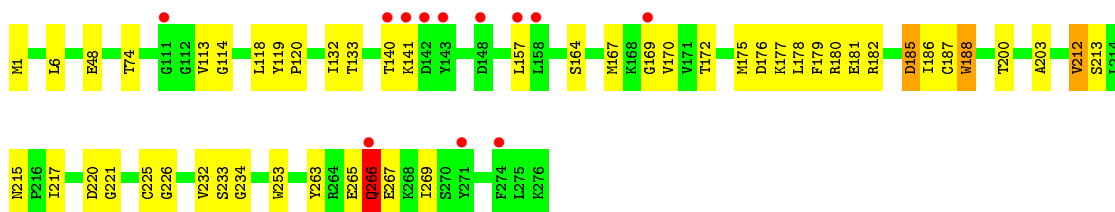
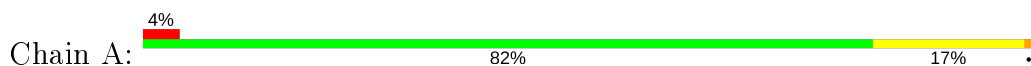

- Molecule 1: Dihydroorotate dehydrogenase B (NAD(+)), electron transfer subunit homolog

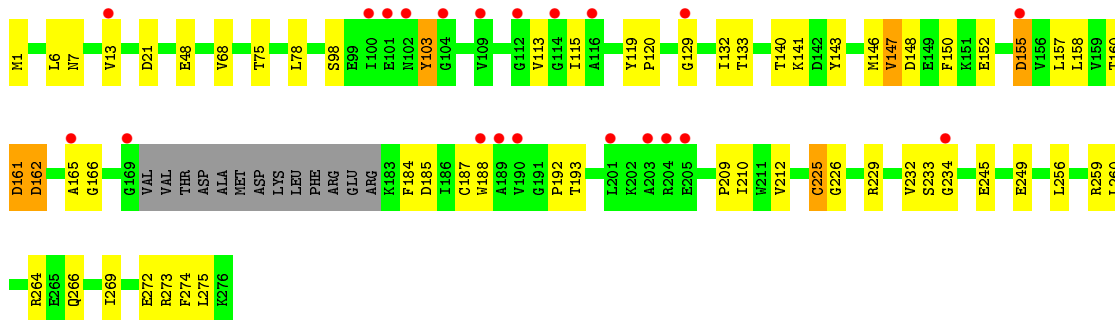

- Molecule 2: Dihydropyrimidine dehydrogenase subunit A

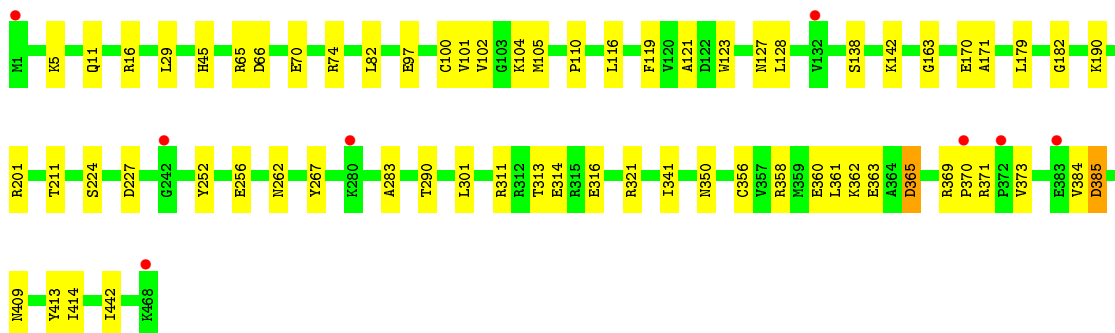
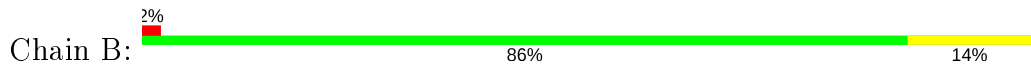

● Molecule 2: Dihydropyrimidine dehydrogenase subunit A

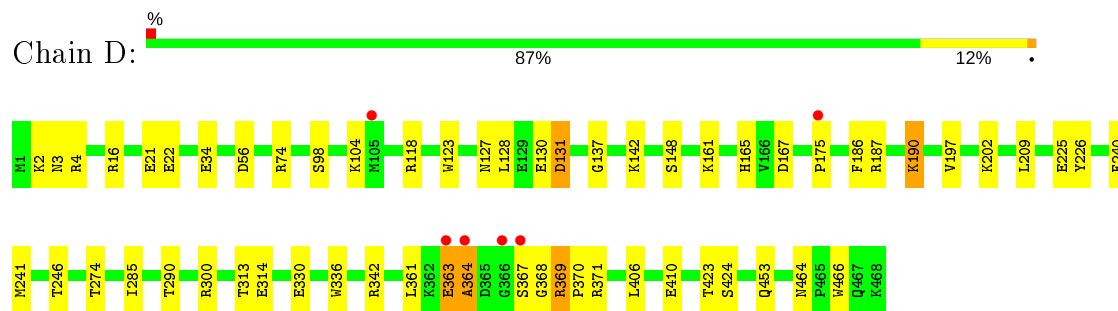

4 Data and refinement statistics

Property	Value	Source
Space group	P 43	Depositor
Cell constants a, b, c, α , β , γ	81.42Å 81.42Å 311.48Å 90.00° 90.00° 90.00°	Depositor
Resolution (Å)	46.29 – 2.30 46.29 – 2.30	Depositor EDS
% Data completeness (in resolution range)	96.9 (46.29-2.30) 96.9 (46.29-2.30)	Depositor EDS
R_{merge}	(Not available)	Depositor
R_{sym}	0.08	Depositor
$\langle I/\sigma(I) \rangle$ ¹	2.56 (at 2.29Å)	Xtrriage
Refinement program	PHENIX (phenix.refine: 1.9_1692)	Depositor
R, R_{free}	0.187 , 0.219 0.194 , 0.222	Depositor DCC
R_{free} test set	4317 reflections (4.99%)	wwPDB-VP
Wilson B-factor (Å ²)	35.8	Xtrriage
Anisotropy	0.451	Xtrriage
Bulk solvent k_{sol} (e/Å ³), B_{sol} (Å ²)	0.29 , 29.4	EDS
L-test for twinning ²	$\langle L \rangle = 0.43$, $\langle L^2 \rangle = 0.26$	Xtrriage
Estimated twinning fraction	0.447 for h,-k,-l	Xtrriage
F_o, F_c correlation	0.95	EDS
Total number of atoms	11843	wwPDB-VP
Average B, all atoms (Å ²)	58.0	wwPDB-VP

Xtrriage's analysis on translational NCS is as follows: *The largest off-origin peak in the Patterson function is 4.31% of the height of the origin peak. No significant pseudotranslation is detected.*

¹Intensities estimated from amplitudes.

²Theoretical values of $\langle |L| \rangle$, $\langle L^2 \rangle$ for acentric reflections are 0.5, 0.333 respectively for untwinned datasets, and 0.375, 0.2 for perfectly twinned datasets.

5 Model quality [i](#)

5.1 Standard geometry [i](#)

Bond lengths and bond angles in the following residue types are not validated in this section: SF4, PO4, FAD, FES

The Z score for a bond length (or angle) is the number of standard deviations the observed value is removed from the expected value. A bond length (or angle) with $|Z| > 5$ is considered an outlier worth inspection. RMSZ is the root-mean-square of all Z scores of the bond lengths (or angles).

Mol	Chain	Bond lengths		Bond angles	
		RMSZ	# Z >5	RMSZ	# Z >5
1	A	0.32	0/2178	0.55	0/2939
1	C	0.33	0/2067	0.57	0/2789
2	B	0.34	0/3697	0.51	0/4994
2	D	0.35	0/3697	0.52	0/4994
All	All	0.34	0/11639	0.53	0/15716

Chiral center outliers are detected by calculating the chiral volume of a chiral center and verifying if the center is modelled as a planar moiety or with the opposite hand. A planarity outlier is detected by checking planarity of atoms in a peptide group, atoms in a mainchain group or atoms of a sidechain that are expected to be planar.

Mol	Chain	#Chirality outliers	#Planarity outliers
1	A	0	1

There are no bond length outliers.

There are no bond angle outliers.

There are no chirality outliers.

All (1) planarity outliers are listed below:

Mol	Chain	Res	Type	Group
1	A	266	GLN	Peptide

5.2 Too-close contacts [i](#)

In the following table, the Non-H and H(model) columns list the number of non-hydrogen atoms and hydrogen atoms in the chain respectively. The H(added) column lists the number of hydrogen atoms added and optimized by MolProbity. The Clashes column lists the number of clashes within the asymmetric unit, whereas Symm-Clashes lists symmetry related clashes.

Mol	Chain	Non-H	H(model)	H(added)	Clashes	Symm-Clashes
1	A	2140	0	2188	27	0
1	C	2031	0	2075	33	0
2	B	3625	0	3646	33	0
2	D	3625	0	3646	39	0
3	A	4	0	0	1	0
3	C	4	0	0	0	0
4	A	53	0	30	5	0
4	B	53	0	30	2	0
4	C	53	0	31	2	0
4	D	53	0	30	3	0
5	B	16	0	0	1	0
5	D	16	0	0	0	0
6	B	5	0	0	1	0
6	D	5	0	0	0	0
7	A	21	0	0	1	0
7	B	58	0	0	5	0
7	C	18	0	0	0	0
7	D	63	0	0	7	0
All	All	11843	0	11676	133	0

The all-atom clashscore is defined as the number of clashes found per 1000 atoms (including hydrogen atoms). The all-atom clashscore for this structure is 6.

All (133) close contacts within the same asymmetric unit are listed below, sorted by their clash magnitude.

Atom-1	Atom-2	Interatomic distance (Å)	Clash overlap (Å)
1:C:48:GLU:OE2	1:C:266:GLN:NE2	2.20	0.74
2:B:121:ALA:O	7:B:601:HOH:O	2.06	0.73
2:D:16:ARG:O	2:D:300:ARG:NH1	2.22	0.72
2:D:187:ARG:NH2	4:D:503:FAD:O4	2.21	0.72
2:B:385:ASP:OD1	2:B:385:ASP:N	2.23	0.71
2:B:290:THR:HA	4:B:503:FAD:HM73	1.73	0.71
1:A:178:LEU:O	1:A:182:ARG:N	2.25	0.70
2:B:171:ALA:O	7:B:602:HOH:O	2.09	0.70
2:B:414:ILE:O	7:B:603:HOH:O	2.09	0.70
2:D:161:LYS:NZ	7:D:604:HOH:O	2.24	0.69
2:B:313:THR:OG1	2:B:316:GLU:OE1	2.10	0.68
2:B:442:ILE:HD12	5:B:502:SF4:S3	2.34	0.67
2:D:148:SER:OG	2:D:175:PRO:O	2.08	0.67
1:A:1:MET:N	1:C:249:GLU:O	2.30	0.65
1:A:263:TYR:HH	2:B:252:TYR:HH	1.38	0.64
2:D:290:THR:HA	4:D:503:FAD:HM73	1.78	0.64

Continued on next page...

Continued from previous page...

Atom-1	Atom-2	Interatomic distance (Å)	Clash overlap (Å)
1:A:187:CYS:SG	1:A:188:TRP:N	2.71	0.63
2:B:182:GLY:O	2:B:262:ASN:ND2	2.32	0.63
1:A:220:ASP:OD1	1:A:221:GLY:N	2.32	0.63
6:B:504:PO4:O1	7:B:601:HOH:O	2.16	0.62
4:D:503:FAD:O4'	4:D:503:FAD:O2'	2.17	0.62
2:D:300:ARG:NH1	7:D:601:HOH:O	2.35	0.60
1:A:266:GLN:OE1	1:A:266:GLN:N	2.34	0.60
1:C:161:ASP:OD2	1:C:165:ALA:N	2.35	0.59
2:B:409:ASN:OD1	2:B:413:TYR:N	2.36	0.58
2:D:148:SER:O	2:D:148:SER:OG	2.22	0.58
1:A:232:VAL:O	1:A:234:GLY:N	2.37	0.57
2:B:360:GLU:N	2:B:373:VAL:O	2.37	0.57
2:D:406:LEU:CD1	2:D:423:THR:HG21	2.34	0.57
1:C:132:ILE:N	1:C:155:ASP:OD2	2.33	0.57
2:D:313:THR:OG1	2:D:314:GLU:N	2.38	0.57
2:D:21:GLU:O	7:D:601:HOH:O	2.17	0.56
1:A:172:THR:HA	1:A:175:MET:HE3	1.91	0.53
2:D:406:LEU:CD1	2:D:423:THR:CG2	2.86	0.53
2:D:406:LEU:HD11	2:D:423:THR:HG21	1.91	0.53
2:B:256:GLU:OE1	7:B:604:HOH:O	2.18	0.53
1:A:177:LYS:O	1:A:180:ARG:NH2	2.42	0.53
2:B:138:SER:N	2:B:163:GLY:O	2.40	0.53
2:B:45:HIS:O	2:B:45:HIS:ND1	2.41	0.51
2:B:65:ARG:HG2	2:B:66:ASP:N	2.26	0.50
1:A:226:GLY:N	3:A:501:FES:S2	2.77	0.50
2:D:342:ARG:NH2	7:D:614:HOH:O	2.45	0.50
1:C:161:ASP:OD2	1:C:166:GLY:N	2.43	0.50
1:A:215:ASN:HA	4:A:502:FAD:HM83	1.93	0.49
2:D:423:THR:HG22	2:D:424:SER:N	2.27	0.49
2:D:22:GLU:HA	2:D:186:PHE:HA	1.93	0.49
2:B:267:TYR:HB3	2:B:301:LEU:HD21	1.94	0.49
1:C:232:VAL:O	1:C:234:GLY:N	2.45	0.49
2:B:100:CYS:SG	2:B:102:VAL:HG22	2.53	0.49
2:D:4:ARG:NH2	7:D:613:HOH:O	2.44	0.49
1:C:6:LEU:HG	1:C:7:ASN:H	1.77	0.49
1:A:48:GLU:OE2	1:A:74:THR:OG1	2.29	0.49
1:C:273:ARG:O	1:C:275:LEU:N	2.45	0.48
1:C:75:THR:OG1	4:C:301:FAD:O2P	2.20	0.48
4:C:301:FAD:O4'	4:C:301:FAD:O2'	2.25	0.48
2:B:102:VAL:HG23	2:B:110:PRO:HA	1.96	0.48
2:B:170:GLU:OE2	4:B:503:FAD:O2B	2.27	0.47

Continued on next page...

Continued from previous page...

Atom-1	Atom-2	Interatomic distance (Å)	Clash overlap (Å)
1:C:266:GLN:HA	1:C:269:ILE:HG22	1.96	0.47
2:D:175:PRO:CB	2:D:197:VAL:HG21	2.43	0.47
1:C:273:ARG:C	1:C:275:LEU:H	2.18	0.47
2:D:118:ARG:NH1	7:D:615:HOH:O	2.48	0.47
1:C:147:VAL:HG12	1:C:150:PHE:HB2	1.97	0.47
1:C:98:SER:OG	1:C:245:GLU:OE1	2.32	0.47
2:B:123:TRP:O	2:B:127:ASN:ND2	2.41	0.47
1:C:225:CYS:SG	1:C:226:GLY:N	2.88	0.47
1:A:212:VAL:HG11	1:A:253:TRP:CH2	2.50	0.47
1:C:152:GLU:HG3	1:C:157:LEU:HD13	1.96	0.46
2:B:5:LYS:NZ	2:B:97:GLU:OE2	2.41	0.46
1:C:146:MET:O	1:C:148:ASP:N	2.49	0.46
1:A:266:GLN:HB3	4:A:502:FAD:H52A	1.98	0.45
1:C:103:TYR:N	1:C:103:TYR:CD1	2.84	0.45
2:D:423:THR:HG22	2:D:424:SER:H	1.82	0.45
2:B:29:LEU:HA	2:B:119:PHE:CZ	2.51	0.45
1:C:115:ILE:HG23	1:C:146:MET:HG2	1.99	0.45
1:C:187:CYS:SG	1:C:188:TRP:N	2.89	0.45
2:D:131:ASP:OD2	2:D:202:LYS:NZ	2.43	0.45
2:D:406:LEU:HD11	2:D:423:THR:CG2	2.45	0.45
2:B:101:VAL:HA	2:B:104:LYS:HG2	1.99	0.45
2:D:369:ARG:HB3	2:D:370:PRO:HD2	1.99	0.44
2:D:241:MET:HE1	2:D:285:ILE:HG21	1.99	0.44
1:C:157:LEU:HD23	1:C:158:LEU:N	2.32	0.44
2:D:314:GLU:HA	2:D:336:TRP:CH2	2.53	0.44
1:A:225:CYS:SG	1:A:226:GLY:N	2.90	0.44
2:D:123:TRP:O	2:D:127:ASN:N	2.50	0.44
2:D:363:GLU:O	2:D:364:ALA:HB2	2.18	0.44
1:C:212:VAL:O	1:C:245:GLU:HA	2.18	0.44
2:D:300:ARG:NH2	2:D:330:GLU:OE2	2.51	0.44
1:C:68:VAL:HG11	1:C:78:LEU:HD23	2.00	0.43
1:A:132:ILE:HG22	1:A:133:THR:N	2.33	0.43
2:D:142:LYS:HA	2:D:165:HIS:HB2	2.00	0.43
2:B:365:ASP:HA	2:B:370:PRO:HA	2.00	0.43
1:C:13:VAL:HG23	1:C:21:ASP:HB3	1.99	0.43
2:D:464:ASN:ND2	2:D:466:TRP:O	2.52	0.43
1:A:217:ILE:HA	4:A:502:FAD:N6A	2.33	0.43
1:A:266:GLN:CB	4:A:502:FAD:H52A	2.49	0.43
1:C:119:TYR:N	1:C:120:PRO:HD2	2.33	0.43
2:D:98:SER:O	2:D:104:LYS:NZ	2.34	0.42
2:D:367:SER:O	2:D:369:ARG:N	2.48	0.42

Continued on next page...

Continued from previous page...

Atom-1	Atom-2	Interatomic distance (Å)	Clash overlap (Å)
1:A:140:THR:OG1	1:A:141:LYS:N	2.52	0.42
1:A:266:GLN:HA	1:A:269:ILE:HG22	2.01	0.42
1:C:141:LYS:HG3	1:C:165:ALA:HB2	2.01	0.42
1:A:213:SER:OG	7:A:601:HOH:O	2.22	0.42
1:C:229:ARG:NH2	2:D:246:THR:O	2.53	0.42
1:A:175:MET:O	1:A:176:ASP:HB3	2.19	0.42
4:A:502:FAD:H1'1	4:A:502:FAD:H9	1.93	0.42
2:D:190:LYS:N	2:D:190:LYS:HD2	2.35	0.42
1:C:161:ASP:OD1	1:C:162:ASP:N	2.53	0.42
2:B:11:GLN:HB3	2:B:16:ARG:HB3	2.01	0.41
1:A:119:TYR:N	1:A:120:PRO:HD2	2.35	0.41
2:B:70:GLU:O	2:B:74:ARG:HG2	2.20	0.41
2:B:170:GLU:O	2:B:211:THR:N	2.48	0.41
2:D:74:ARG:O	7:D:602:HOH:O	2.21	0.41
2:D:175:PRO:HB3	2:D:197:VAL:HG21	2.02	0.41
1:A:114:GLY:O	1:A:118:LEU:N	2.54	0.41
1:C:160:THR:HG22	1:C:161:ASP:N	2.35	0.41
1:A:265:GLU:O	1:A:266:GLN:HB2	2.21	0.41
2:B:363:GLU:HB3	2:B:371:ARG:HB3	2.02	0.41
1:C:1:MET:N	1:C:1:MET:SD	2.87	0.41
2:B:142:LYS:O	2:B:227:ASP:N	2.54	0.41
2:D:369:ARG:HE	2:D:370:PRO:HD2	1.86	0.41
1:C:119:TYR:HE1	1:C:150:PHE:HB3	1.85	0.41
1:C:113:VAL:HB	1:C:192:PRO:HG3	2.02	0.41
1:C:272:GLU:O	1:C:275:LEU:HD13	2.20	0.41
1:A:200:THR:O	1:A:203:ALA:N	2.49	0.40
1:C:193:THR:HG21	1:C:260:LEU:HD11	2.02	0.40
2:D:137:GLY:HA2	2:D:165:HIS:CD2	2.56	0.40
1:A:265:GLU:C	1:A:267:GLU:H	2.25	0.40
2:B:341:ILE:HD12	2:B:356:CYS:HA	2.03	0.40
2:B:369:ARG:O	2:B:370:PRO:C	2.59	0.40
2:D:175:PRO:HB2	2:D:197:VAL:HG21	2.02	0.40
2:D:225:GLU:HG3	2:D:226:TYR:CD2	2.57	0.40
2:B:283:ALA:HB2	2:B:384:VAL:HG11	2.04	0.40
2:B:369:ARG:HD2	2:B:370:PRO:HD3	2.04	0.40

There are no symmetry-related clashes.

5.3 Torsion angles [i](#)

5.3.1 Protein backbone [i](#)

In the following table, the Percentiles column shows the percent Ramachandran outliers of the chain as a percentile score with respect to all X-ray entries followed by that with respect to entries of similar resolution.

The Analysed column shows the number of residues for which the backbone conformation was analysed, and the total number of residues.

Mol	Chain	Analysed	Favoured	Allowed	Outliers	Percentiles	
1	A	274/276 (99%)	242 (88%)	27 (10%)	5 (2%)	8	7
1	C	259/276 (94%)	222 (86%)	30 (12%)	7 (3%)	5	3
2	B	466/468 (100%)	440 (94%)	25 (5%)	1 (0%)	47	58
2	D	466/468 (100%)	440 (94%)	19 (4%)	7 (2%)	10	10
All	All	1465/1488 (98%)	1344 (92%)	101 (7%)	20 (1%)	11	11

All (20) Ramachandran outliers are listed below:

Mol	Chain	Res	Type
2	D	363	GLU
2	B	362	LYS
2	D	131	ASP
2	D	364	ALA
1	A	6	LEU
1	A	169	GLY
1	A	185	ASP
1	A	233	SER
1	C	233	SER
1	C	256	LEU
1	C	274	PHE
1	A	167	MET
1	C	155	ASP
2	D	130	GLU
1	C	129	GLY
2	D	56	ASP
1	C	147	VAL
1	C	209	PRO
2	D	368	GLY
2	D	369	ARG

5.3.2 Protein sidechains [i](#)

In the following table, the Percentiles column shows the percent sidechain outliers of the chain as a percentile score with respect to all X-ray entries followed by that with respect to entries of similar resolution.

The Analysed column shows the number of residues for which the sidechain conformation was analysed, and the total number of residues.

Mol	Chain	Analysed	Rotameric	Outliers	Percentiles	
1	A	233/233 (100%)	222 (95%)	11 (5%)	26	37
1	C	221/233 (95%)	209 (95%)	12 (5%)	22	30
2	B	381/381 (100%)	365 (96%)	16 (4%)	30	42
2	D	381/381 (100%)	368 (97%)	13 (3%)	37	51
All	All	1216/1228 (99%)	1164 (96%)	52 (4%)	29	40

All (52) residues with a non-rotameric sidechain are listed below:

Mol	Chain	Res	Type
1	A	113	VAL
1	A	157	LEU
1	A	164	SER
1	A	170	VAL
1	A	179	PHE
1	A	181	GLU
1	A	185	ASP
1	A	186	ILE
1	A	188	TRP
1	A	212	VAL
1	A	266	GLN
2	B	82	LEU
2	B	105	MET
2	B	116	LEU
2	B	128	LEU
2	B	179	LEU
2	B	190	LYS
2	B	201	ARG
2	B	224	SER
2	B	311	ARG
2	B	314	GLU
2	B	321	ARG
2	B	350	ASN
2	B	358	ARG

Continued on next page...

Continued from previous page...

Mol	Chain	Res	Type
2	B	361	LEU
2	B	365	ASP
2	B	385	ASP
1	C	103	TYR
1	C	133	THR
1	C	140	THR
1	C	143	TYR
1	C	161	ASP
1	C	162	ASP
1	C	184	PHE
1	C	185	ASP
1	C	210	ILE
1	C	225	CYS
1	C	259	ARG
1	C	264	ARG
2	D	2	LYS
2	D	3	ASN
2	D	34	GLU
2	D	128	LEU
2	D	167	ASP
2	D	190	LYS
2	D	209	LEU
2	D	240	PHE
2	D	274	THR
2	D	361	LEU
2	D	371	ARG
2	D	410	GLU
2	D	453	GLN

Some sidechains can be flipped to improve hydrogen bonding and reduce clashes. All (1) such sidechains are listed below:

Mol	Chain	Res	Type
2	B	11	GLN

5.3.3 RNA

There are no RNA molecules in this entry.

5.4 Non-standard residues in protein, DNA, RNA chains [i](#)

There are no non-standard protein/DNA/RNA residues in this entry.

5.5 Carbohydrates [i](#)

There are no carbohydrates in this entry.

5.6 Ligand geometry [i](#)

12 ligands are modelled in this entry.

In the following table, the Counts columns list the number of bonds (or angles) for which Mogul statistics could be retrieved, the number of bonds (or angles) that are observed in the model and the number of bonds (or angles) that are defined in the Chemical Component Dictionary. The Link column lists molecule types, if any, to which the group is linked. The Z score for a bond length (or angle) is the number of standard deviations the observed value is removed from the expected value. A bond length (or angle) with $|Z| > 2$ is considered an outlier worth inspection. RMSZ is the root-mean-square of all Z scores of the bond lengths (or angles).

Mol	Type	Chain	Res	Link	Bond lengths			Bond angles		
					Counts	RMSZ	# Z > 2	Counts	RMSZ	# Z > 2
5	SF4	D	502	2	0,12,12	0.00	-	-	-	-
4	FAD	B	503	-	51,58,58	4.15	18 (35%)	60,89,89	2.25	12 (20%)
5	SF4	B	502	2	0,12,12	0.00	-	-	-	-
4	FAD	A	502	-	51,58,58	4.16	18 (35%)	60,89,89	2.26	12 (20%)
5	SF4	D	501	2	0,12,12	0.00	-	-	-	-
4	FAD	C	301	-	51,58,58	4.17	18 (35%)	60,89,89	2.32	14 (23%)
6	PO4	B	504	-	4,4,4	0.88	0	6,6,6	0.56	0
3	FES	A	501	1	0,4,4	0.00	-	-	-	-
6	PO4	D	504	-	4,4,4	1.04	0	6,6,6	0.60	0
3	FES	C	302	1	0,4,4	0.00	-	-	-	-
4	FAD	D	503	-	51,58,58	4.19	19 (37%)	60,89,89	2.19	11 (18%)
5	SF4	B	501	2	0,12,12	0.00	-	-	-	-

In the following table, the Chirals column lists the number of chiral outliers, the number of chiral centers analysed, the number of these observed in the model and the number defined in the Chemical Component Dictionary. Similar counts are reported in the Torsion and Rings columns. '-' means no outliers of that kind were identified.

Mol	Type	Chain	Res	Link	Chirals	Torsions	Rings
5	SF4	D	502	2	-	-	0/6/5/5
4	FAD	B	503	-	-	2/30/50/50	0/6/6/6

Continued on next page...

Continued from previous page...

Mol	Type	Chain	Res	Link	Chirals	Torsions	Rings
5	SF4	B	502	2	-	-	0/6/5/5
4	FAD	A	502	-	-	9/30/50/50	0/6/6/6
5	SF4	D	501	2	-	-	0/6/5/5
4	FAD	C	301	-	-	7/30/50/50	0/6/6/6
3	FES	A	501	1	-	-	0/1/1/1
3	FES	C	302	1	-	-	0/1/1/1
5	SF4	B	501	2	-	-	0/6/5/5
4	FAD	D	503	-	-	3/30/50/50	0/6/6/6

All (73) bond length outliers are listed below:

Mol	Chain	Res	Type	Atoms	Z	Observed(Å)	Ideal(Å)
4	B	503	FAD	C2B-C1B	-15.44	1.30	1.53
4	C	301	FAD	O4B-C1B	15.38	1.62	1.41
4	D	503	FAD	C2B-C1B	-15.16	1.30	1.53
4	A	502	FAD	O4B-C1B	15.00	1.62	1.41
4	A	502	FAD	C2B-C1B	-14.87	1.31	1.53
4	D	503	FAD	O4B-C1B	14.75	1.61	1.41
4	B	503	FAD	O4B-C1B	14.56	1.61	1.41
4	C	301	FAD	C2B-C1B	-14.47	1.31	1.53
4	D	503	FAD	C9A-N10	8.57	1.50	1.38
4	B	503	FAD	C9A-N10	8.17	1.49	1.38
4	C	301	FAD	C9A-N10	8.09	1.49	1.38
4	A	502	FAD	C9A-N10	8.08	1.49	1.38
4	A	502	FAD	C4X-N5	7.76	1.44	1.33
4	D	503	FAD	C10-N1	7.69	1.43	1.33
4	C	301	FAD	C4X-N5	7.65	1.44	1.33
4	B	503	FAD	C4X-N5	7.50	1.44	1.33
4	D	503	FAD	C4X-N5	7.12	1.43	1.33
4	B	503	FAD	C10-N1	7.10	1.42	1.33
4	B	503	FAD	O4B-C4B	-6.77	1.29	1.45
4	C	301	FAD	C10-N1	6.73	1.41	1.33
4	A	502	FAD	C10-N1	6.70	1.41	1.33
4	D	503	FAD	O4B-C4B	-6.69	1.30	1.45
4	A	502	FAD	O4B-C4B	-6.68	1.30	1.45
4	C	301	FAD	C5X-N5	6.65	1.46	1.35
4	C	301	FAD	O4B-C4B	-6.60	1.30	1.45
4	B	503	FAD	C5X-N5	6.52	1.46	1.35
4	A	502	FAD	C5X-N5	6.43	1.46	1.35
4	D	503	FAD	C5X-N5	6.04	1.45	1.35
4	B	503	FAD	C4-N3	5.60	1.42	1.33
4	D	503	FAD	C4-N3	5.44	1.42	1.33

Continued on next page...

Continued from previous page...

Mol	Chain	Res	Type	Atoms	Z	Observed(Å)	Ideal(Å)
4	C	301	FAD	C4-N3	5.37	1.42	1.33
4	A	502	FAD	C4-N3	5.36	1.42	1.33
4	C	301	FAD	C4X-C10	5.03	1.43	1.38
4	A	502	FAD	C4X-C10	4.84	1.43	1.38
4	B	503	FAD	C4X-C10	4.72	1.43	1.38
4	D	503	FAD	C4X-C10	4.64	1.43	1.38
4	C	301	FAD	C4-C4X	4.46	1.49	1.41
4	D	503	FAD	C2-N1	4.38	1.46	1.38
4	A	502	FAD	C2-N3	4.20	1.46	1.38
4	C	301	FAD	C2-N3	4.18	1.46	1.38
4	A	502	FAD	C2-N1	4.17	1.46	1.38
4	A	502	FAD	C4-C4X	4.09	1.48	1.41
4	D	503	FAD	C2-N3	4.06	1.46	1.38
4	B	503	FAD	C2-N3	4.03	1.46	1.38
4	C	301	FAD	C2-N1	3.86	1.45	1.38
4	D	503	FAD	O2B-C2B	3.54	1.51	1.43
4	B	503	FAD	C4-C4X	3.52	1.47	1.41
4	C	301	FAD	C2A-N3A	3.47	1.37	1.32
4	A	502	FAD	O2B-C2B	3.44	1.51	1.43
4	B	503	FAD	C6A-N6A	3.42	1.46	1.34
4	A	502	FAD	C6A-N6A	3.36	1.46	1.34
4	D	503	FAD	C6A-N6A	3.35	1.46	1.34
4	C	301	FAD	C6A-N6A	3.34	1.46	1.34
4	C	301	FAD	O2B-C2B	3.34	1.50	1.43
4	D	503	FAD	C2A-N3A	3.31	1.37	1.32
4	B	503	FAD	C2-N1	3.30	1.44	1.38
4	B	503	FAD	O2B-C2B	3.28	1.50	1.43
4	D	503	FAD	C4-C4X	3.28	1.47	1.41
4	B	503	FAD	C2A-N3A	3.17	1.37	1.32
4	A	502	FAD	C2A-N3A	3.13	1.37	1.32
4	D	503	FAD	O4-C4	-3.07	1.16	1.24
4	D	503	FAD	O3B-C3B	-2.82	1.36	1.43
4	B	503	FAD	O4-C4	-2.73	1.17	1.24
4	C	301	FAD	C2A-N1A	2.70	1.38	1.33
4	B	503	FAD	O3B-C3B	-2.70	1.36	1.43
4	C	301	FAD	O4-C4	-2.67	1.17	1.24
4	A	502	FAD	O3B-C3B	-2.65	1.36	1.43
4	A	502	FAD	O4-C4	-2.63	1.17	1.24
4	D	503	FAD	C2A-N1A	2.62	1.38	1.33
4	A	502	FAD	C2A-N1A	2.57	1.38	1.33
4	C	301	FAD	O3B-C3B	-2.43	1.37	1.43
4	B	503	FAD	C2A-N1A	2.32	1.38	1.33

Continued on next page...

Continued from previous page...

Mol	Chain	Res	Type	Atoms	Z	Observed(Å)	Ideal(Å)
4	D	503	FAD	C4'-C3'	-2.15	1.49	1.53

All (49) bond angle outliers are listed below:

Mol	Chain	Res	Type	Atoms	Z	Observed(°)	Ideal(°)
4	D	503	FAD	C5A-C6A-N6A	7.08	131.11	120.35
4	B	503	FAD	C5A-C6A-N6A	7.05	131.07	120.35
4	A	502	FAD	C5A-C6A-N6A	7.04	131.04	120.35
4	C	301	FAD	C5A-C6A-N6A	6.88	130.80	120.35
4	C	301	FAD	C7M-C7-C8	6.41	133.88	120.74
4	B	503	FAD	C4-N3-C2	6.14	120.32	115.14
4	D	503	FAD	C7M-C7-C8	6.08	133.20	120.74
4	A	502	FAD	C7M-C7-C8	6.07	133.17	120.74
4	C	301	FAD	C4-N3-C2	6.05	120.25	115.14
4	A	502	FAD	C4-N3-C2	5.96	120.17	115.14
4	C	301	FAD	C7M-C7-C6	-5.91	106.21	120.34
4	B	503	FAD	N3A-C2A-N1A	-5.76	119.67	128.68
4	D	503	FAD	C7M-C7-C6	-5.64	106.86	120.34
4	B	503	FAD	C7M-C7-C6	-5.60	106.95	120.34
4	B	503	FAD	C7M-C7-C8	5.59	132.19	120.74
4	A	502	FAD	C7M-C7-C6	-5.54	107.08	120.34
4	A	502	FAD	N3A-C2A-N1A	-5.47	120.12	128.68
4	D	503	FAD	C4-N3-C2	5.41	119.71	115.14
4	D	503	FAD	N3A-C2A-N1A	-5.28	120.42	128.68
4	B	503	FAD	C1'-N10-C9A	5.10	122.31	118.29
4	C	301	FAD	C1'-N10-C9A	5.05	122.26	118.29
4	C	301	FAD	N3A-C2A-N1A	-5.01	120.85	128.68
4	D	503	FAD	C1'-N10-C9A	4.77	122.05	118.29
4	A	502	FAD	N6A-C6A-N1A	-4.62	108.98	118.57
4	D	503	FAD	N6A-C6A-N1A	-4.58	109.07	118.57
4	B	503	FAD	N6A-C6A-N1A	-4.52	109.18	118.57
4	C	301	FAD	N6A-C6A-N1A	-4.40	109.44	118.57
4	A	502	FAD	C1'-N10-C9A	4.11	121.53	118.29
4	C	301	FAD	C3B-C2B-C1B	3.85	106.78	100.98
4	C	301	FAD	C4X-N5-C5X	3.83	120.60	116.77
4	D	503	FAD	C5X-C9A-N10	3.67	120.37	117.72
4	B	503	FAD	C5X-C9A-N10	3.60	120.32	117.72
4	B	503	FAD	O4B-C1B-C2B	-3.59	101.69	106.93
4	C	301	FAD	C10-C4X-N5	-3.51	118.83	121.26
4	A	502	FAD	C4'-C3'-C2'	-3.34	106.41	113.36
4	A	502	FAD	C4X-N5-C5X	3.27	120.04	116.77
4	A	502	FAD	C5X-C9A-N10	3.24	120.06	117.72

Continued on next page...

Continued from previous page...

Mol	Chain	Res	Type	Atoms	Z	Observed(°)	Ideal(°)
4	D	503	FAD	C4X-N5-C5X	3.03	119.80	116.77
4	C	301	FAD	C4X-C4-N3	-3.01	119.32	123.43
4	D	503	FAD	C4'-C3'-C2'	-2.82	107.50	113.36
4	B	503	FAD	C4X-N5-C5X	2.71	119.48	116.77
4	A	502	FAD	C4X-C4-N3	-2.56	119.93	123.43
4	B	503	FAD	C4X-C4-N3	-2.47	120.05	123.43
4	A	502	FAD	C3B-C2B-C1B	2.47	104.69	100.98
4	C	301	FAD	C5X-C9A-N10	2.42	119.47	117.72
4	C	301	FAD	C4-C4X-N5	2.39	121.33	118.60
4	C	301	FAD	P-O3P-PA	-2.27	125.05	132.83
4	B	503	FAD	C9A-N10-C10	-2.22	119.00	121.91
4	D	503	FAD	C4X-C4-N3	-2.13	120.52	123.43

There are no chirality outliers.

All (21) torsion outliers are listed below:

Mol	Chain	Res	Type	Atoms
4	A	502	FAD	C5B-O5B-PA-O1A
4	A	502	FAD	C5B-O5B-PA-O2A
4	A	502	FAD	C3'-C4'-C5'-O5'
4	A	502	FAD	O4'-C4'-C5'-O5'
4	C	301	FAD	C1'-C2'-C3'-O3'
4	C	301	FAD	C1'-C2'-C3'-C4'
4	A	502	FAD	O4B-C4B-C5B-O5B
4	C	301	FAD	O4B-C4B-C5B-O5B
4	C	301	FAD	O2'-C2'-C3'-O3'
4	A	502	FAD	C3B-C4B-C5B-O5B
4	C	301	FAD	O2'-C2'-C3'-C4'
4	B	503	FAD	PA-O3P-P-O5'
4	A	502	FAD	P-O3P-PA-O5B
4	D	503	FAD	PA-O3P-P-O5'
4	A	502	FAD	C5B-O5B-PA-O3P
4	B	503	FAD	C5'-O5'-P-O1P
4	C	301	FAD	C3B-C4B-C5B-O5B
4	A	502	FAD	PA-O3P-P-O2P
4	D	503	FAD	P-O3P-PA-O1A
4	C	301	FAD	PA-O3P-P-O2P
4	D	503	FAD	O4B-C4B-C5B-O5B

There are no ring outliers.

7 monomers are involved in 15 short contacts:

Mol	Chain	Res	Type	Clashes	Symm-Clashes
4	B	503	FAD	2	0
5	B	502	SF4	1	0
4	A	502	FAD	5	0
4	C	301	FAD	2	0
6	B	504	PO4	1	0
3	A	501	FES	1	0
4	D	503	FAD	3	0

The following is a two-dimensional graphical depiction of Mogul quality analysis of bond lengths, bond angles, torsion angles, and ring geometry for all instances of the Ligand of Interest. In addition, ligands with molecular weight > 250 and outliers as shown on the validation Tables will also be included. For torsion angles, if less than 5% of the Mogul distribution of torsion angles is within 10 degrees of the torsion angle in question, then that torsion angle is considered an outlier. Any bond that is central to one or more torsion angles identified as an outlier by Mogul will be highlighted in the graph. For rings, the root-mean-square deviation (RMSD) between the ring in question and similar rings identified by Mogul is calculated over all ring torsion angles. If the average RMSD is greater than 60 degrees and the minimal RMSD between the ring in question and any Mogul-identified rings is also greater than 60 degrees, then that ring is considered an outlier. The outliers are highlighted in purple. The color gray indicates Mogul did not find sufficient equivalents in the CSD to analyse the geometry.

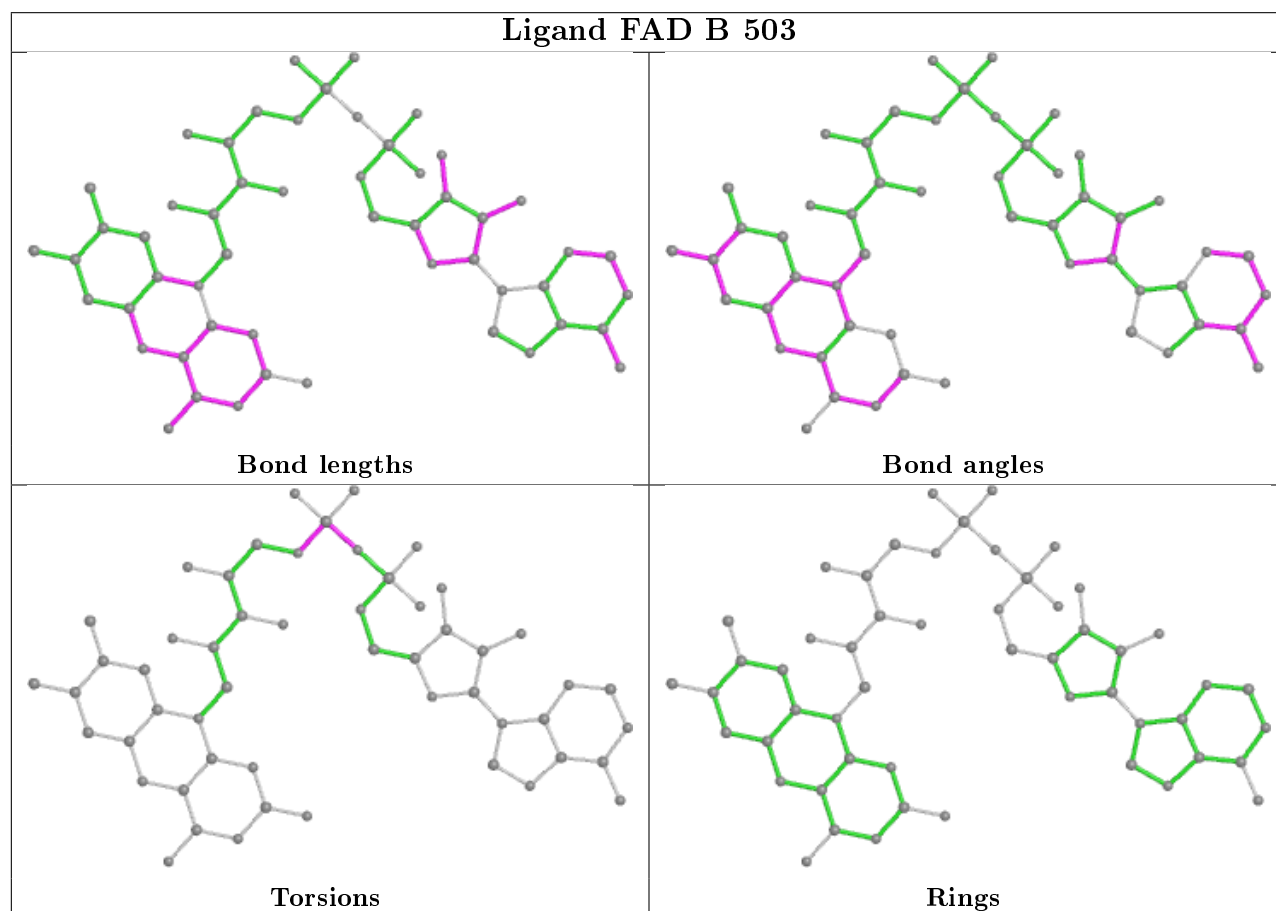

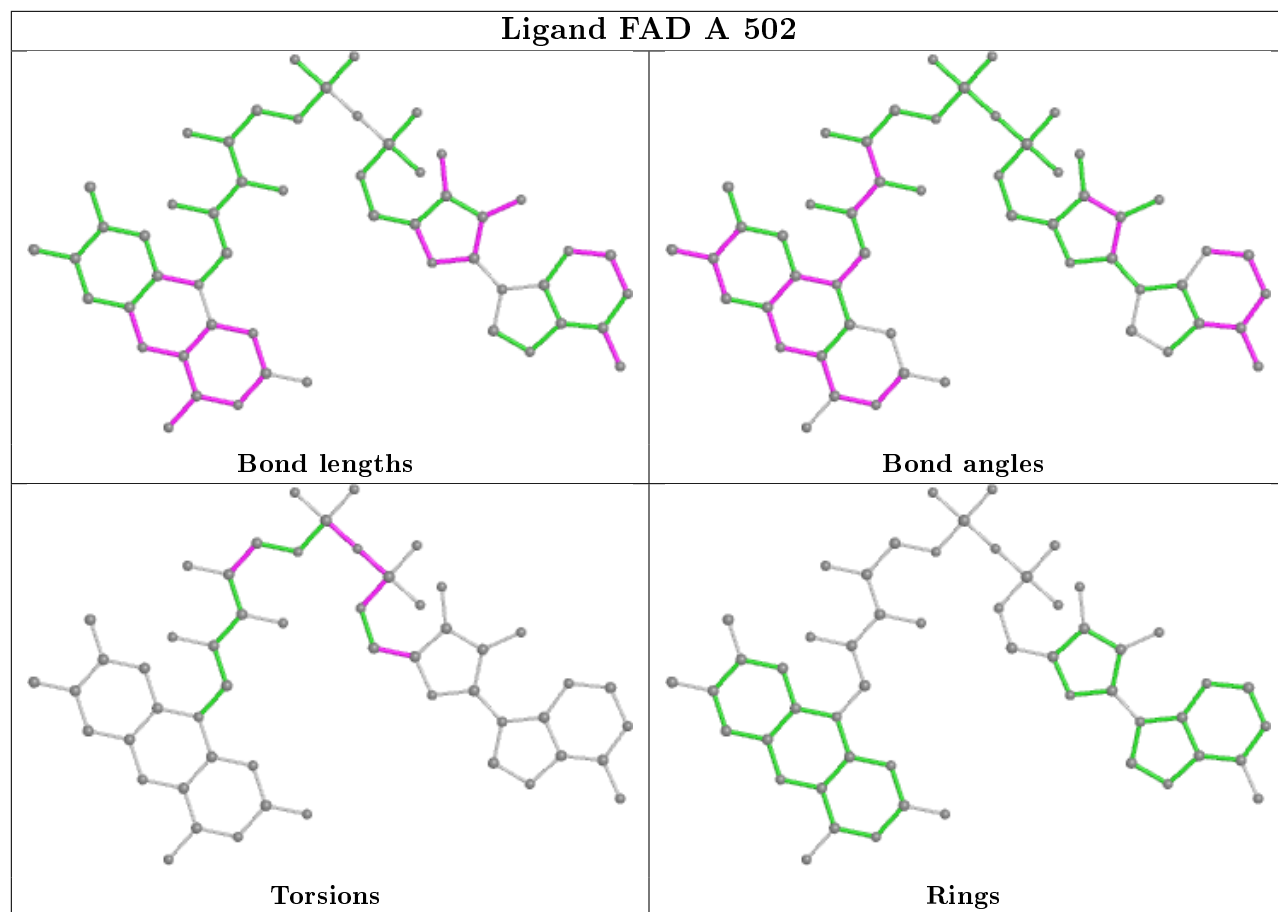

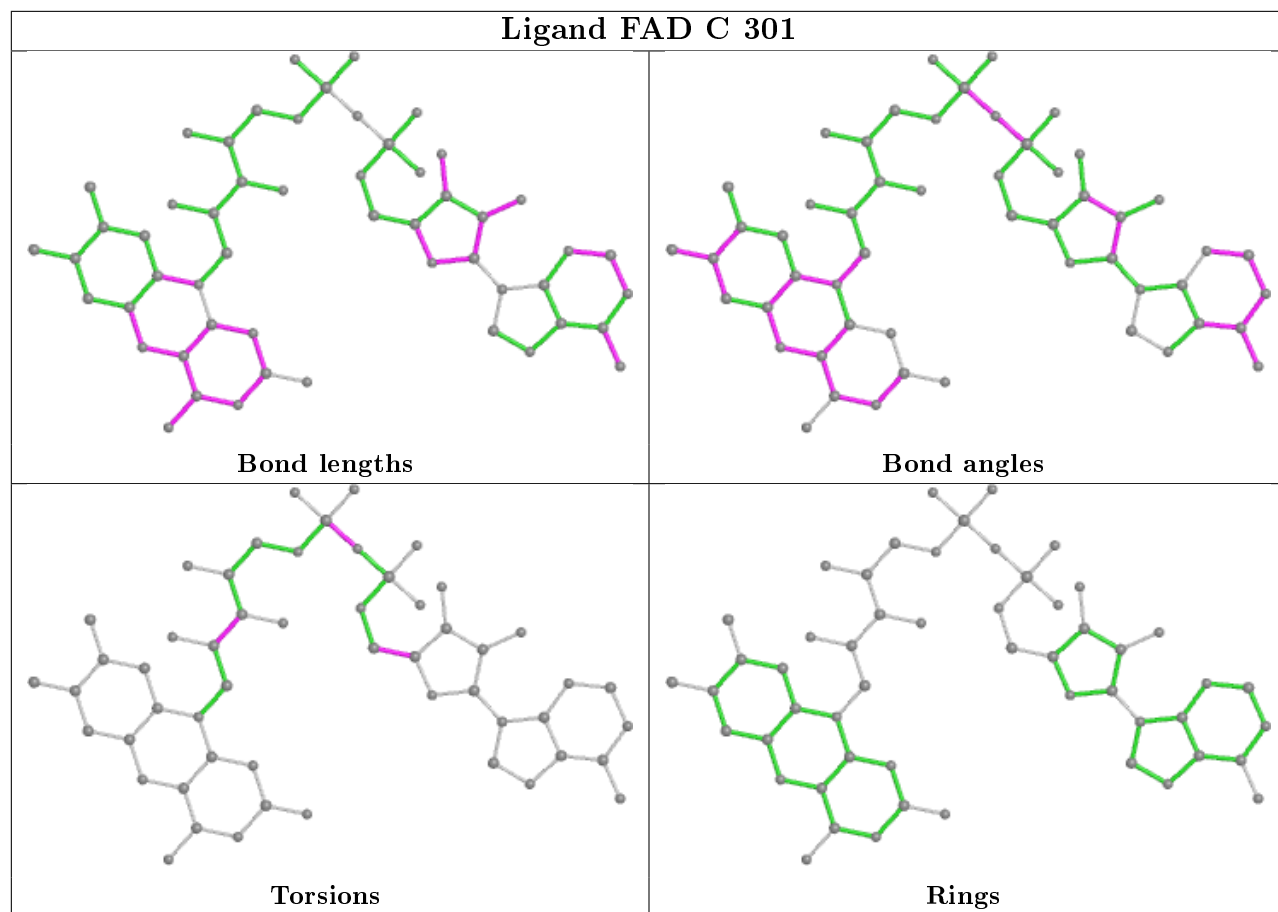

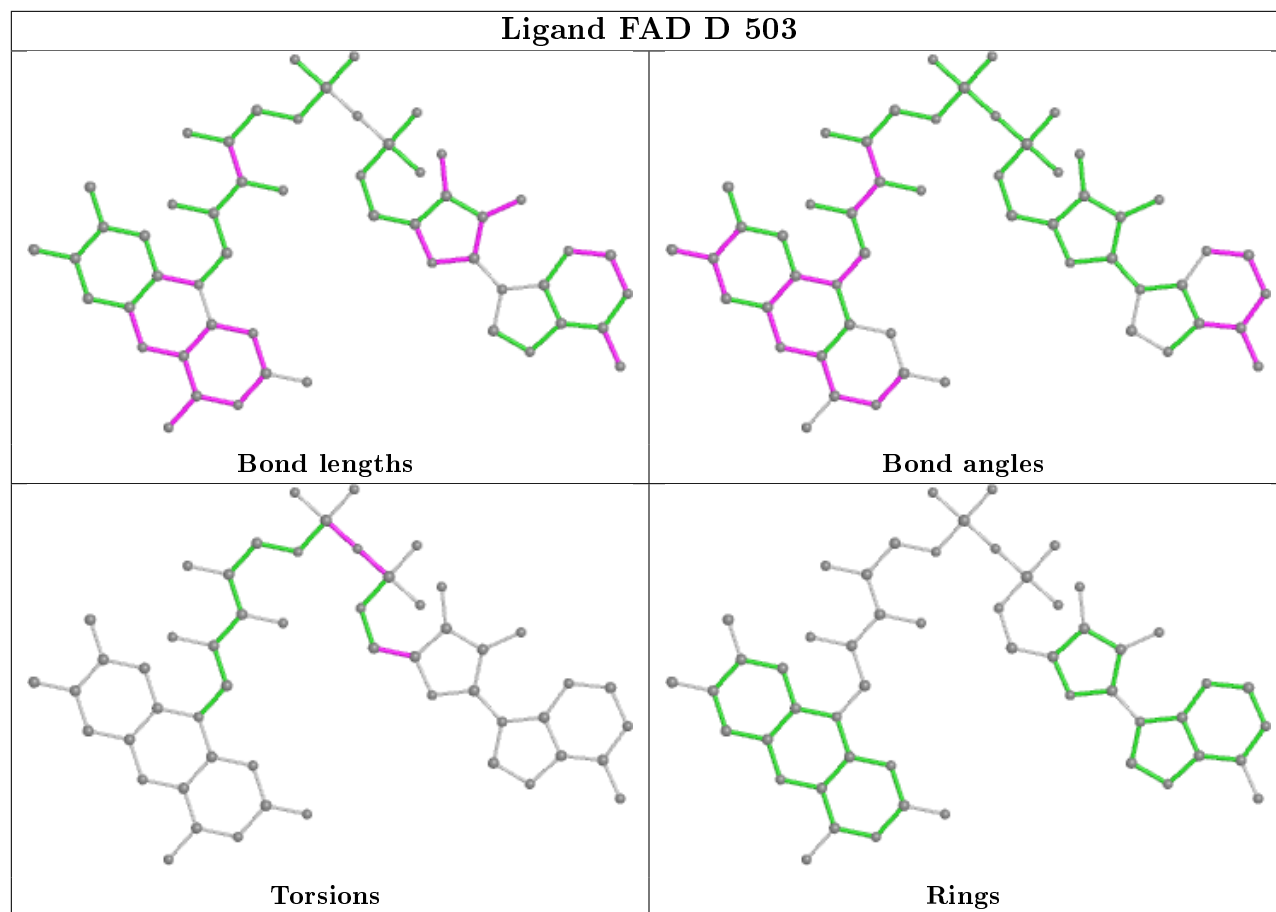

5.7 Other polymers [i](#)

There are no such residues in this entry.

5.8 Polymer linkage issues [i](#)

There are no chain breaks in this entry.

6 Fit of model and data

6.1 Protein, DNA and RNA chains

In the following table, the column labelled ‘#RSRZ> 2’ contains the number (and percentage) of RSRZ outliers, followed by percent RSRZ outliers for the chain as percentile scores relative to all X-ray entries and entries of similar resolution. The OWAB column contains the minimum, median, 95th percentile and maximum values of the occupancy-weighted average B-factor per residue. The column labelled ‘Q< 0.9’ lists the number of (and percentage) of residues with an average occupancy less than 0.9.

Mol	Chain	Analysed	<RSRZ>	#RSRZ>2	OWAB(Å ²)	Q<0.9
1	A	276/276 (100%)	-0.13	12 (4%) 35 42	30, 57, 108, 219	0
1	C	263/276 (95%)	0.15	21 (7%) 12 16	46, 72, 120, 177	0
2	B	468/468 (100%)	-0.42	8 (1%) 70 76	24, 48, 84, 133	0
2	D	468/468 (100%)	-0.40	6 (1%) 77 81	23, 50, 82, 138	0
All	All	1475/1488 (99%)	-0.26	47 (3%) 47 54	23, 54, 99, 219	0

All (47) RSRZ outliers are listed below:

Mol	Chain	Res	Type	RSRZ
1	A	140	THR	12.3
1	C	201	LEU	11.3
1	A	143	TYR	6.4
1	C	203	ALA	6.1
1	A	169	GLY	5.2
2	B	132	VAL	4.9
1	C	190	VAL	4.2
1	A	271	TYR	4.1
1	C	204	ARG	4.0
2	B	280	LYS	3.8
2	D	366	GLY	3.7
2	D	367	SER	3.6
2	D	105	MET	3.5
1	C	114	GLY	3.5
2	D	175	PRO	3.3
2	D	364	ALA	3.2
1	A	141	LYS	3.2
1	C	188	TRP	3.2
1	C	100	ILE	3.1
1	A	157	LEU	3.1
1	C	13	VAL	2.9

Continued on next page...

Continued from previous page...

Mol	Chain	Res	Type	RSRZ
1	C	101	GLU	2.8
1	A	158	LEU	2.8
1	C	102	ASN	2.8
1	C	169	GLY	2.7
1	C	234	GLY	2.6
1	A	148	ASP	2.5
2	B	1	MET	2.4
1	A	142	ASP	2.4
1	C	116	ALA	2.4
2	B	242	GLY	2.4
1	A	111	GLY	2.4
1	C	112	GLY	2.4
1	A	274	PHE	2.3
1	C	205	GLU	2.3
1	C	155	ASP	2.3
2	D	363	GLU	2.2
1	A	266	GLN	2.2
1	C	189	ALA	2.2
2	B	370	PRO	2.1
1	C	104	GLY	2.1
1	C	109	VAL	2.1
2	B	383	GLU	2.1
2	B	372	PRO	2.1
1	C	165	ALA	2.1
1	C	129	GLY	2.1
2	B	468	LYS	2.0

6.2 Non-standard residues in protein, DNA, RNA chains [i](#)

There are no non-standard protein/DNA/RNA residues in this entry.

6.3 Carbohydrates [i](#)

There are no carbohydrates in this entry.

6.4 Ligands [i](#)

In the following table, the Atoms column lists the number of modelled atoms in the group and the number defined in the chemical component dictionary. The B-factors column lists the minimum, median, 95th percentile and maximum values of B factors of atoms in the group. The column labelled 'Q< 0.9' lists the number of atoms with occupancy less than 0.9.

Mol	Type	Chain	Res	Atoms	RSCC	RSR	B-factors(\AA^2)	Q<0.9
5	SF4	D	502	8/8	0.79	0.28	34,82,167,298	0
5	SF4	B	502	8/8	0.91	0.20	22,53,71,108	0
5	SF4	D	501	8/8	0.96	0.21	29,46,118,118	0
4	FAD	C	301	53/53	0.96	0.13	46,57,82,89	0
6	PO4	B	504	5/5	0.96	0.11	56,67,79,93	0
5	SF4	B	501	8/8	0.96	0.21	30,42,162,256	0
4	FAD	A	502	53/53	0.97	0.11	32,44,80,82	0
3	FES	A	501	4/4	0.98	0.10	36,42,60,82	0
4	FAD	B	503	53/53	0.98	0.11	4,31,56,76	0
4	FAD	D	503	53/53	0.98	0.12	21,32,52,54	0
6	PO4	D	504	5/5	0.99	0.08	36,40,51,56	0
3	FES	C	302	4/4	0.99	0.10	43,43,48,50	0

The following is a graphical depiction of the model fit to experimental electron density of all instances of the Ligand of Interest. In addition, ligands with molecular weight > 250 and outliers as shown on the geometry validation Tables will also be included. Each fit is shown from different orientation to approximate a three-dimensional view.

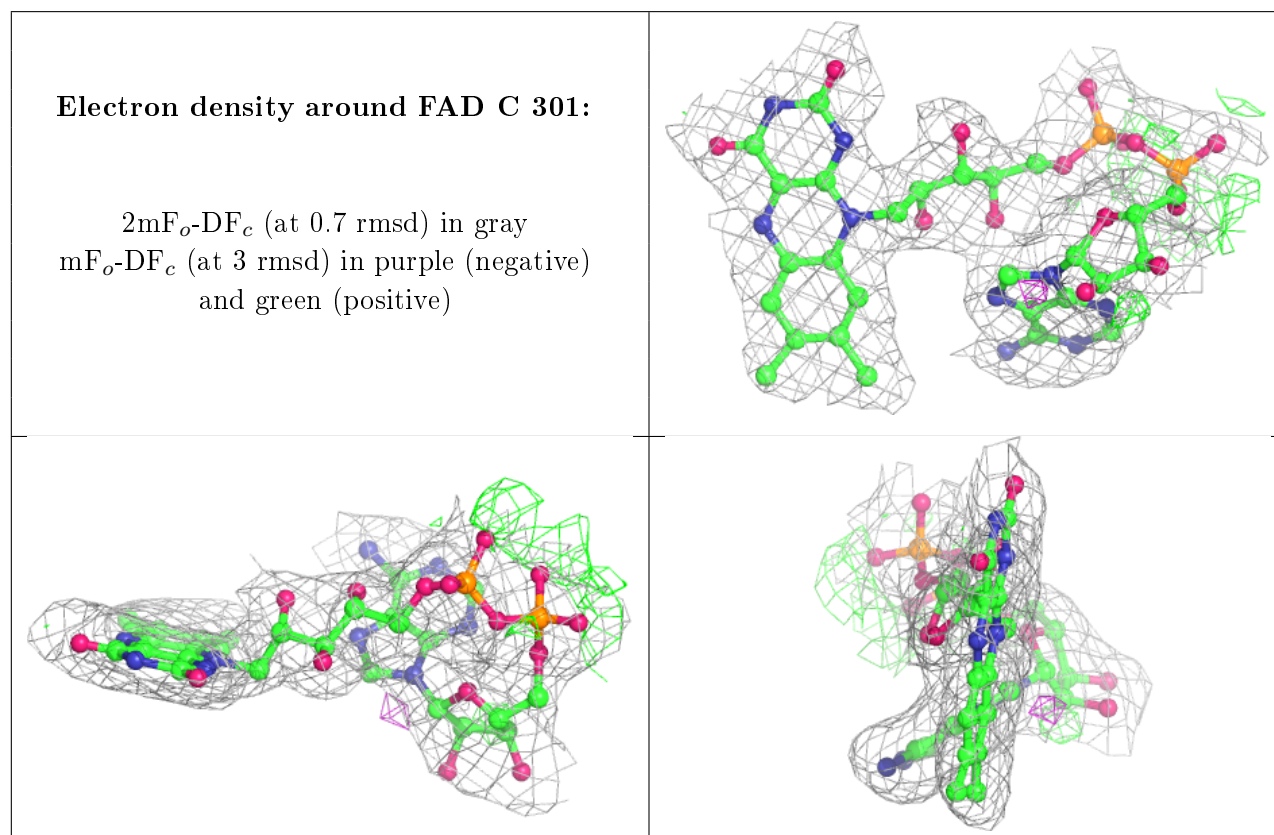

Electron density around FAD A 502:

$2mF_o-DF_c$ (at 0.7 rmsd) in gray
 mF_o-DF_c (at 3 rmsd) in purple (negative)
and green (positive)

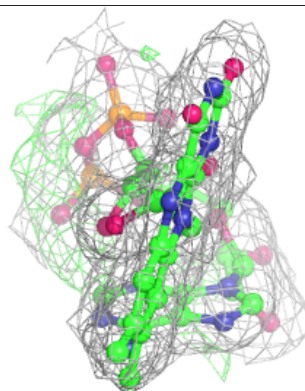
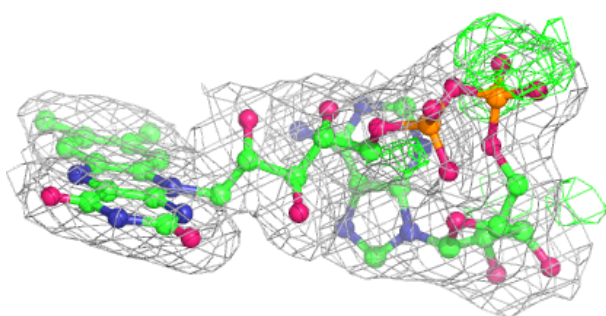
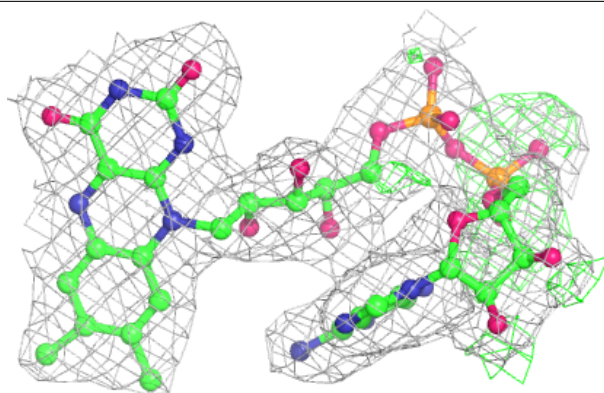
**Electron density around FAD B 503:**

$2mF_o-DF_c$ (at 0.7 rmsd) in gray
 mF_o-DF_c (at 3 rmsd) in purple (negative)
and green (positive)

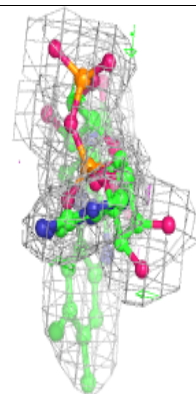
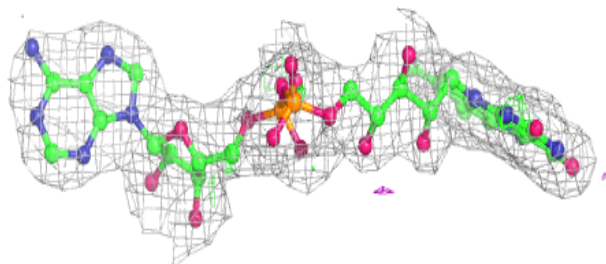
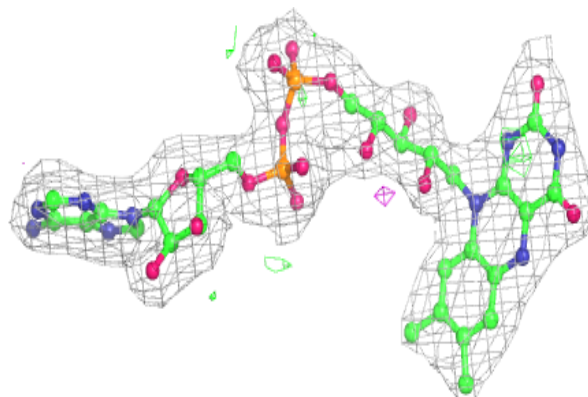

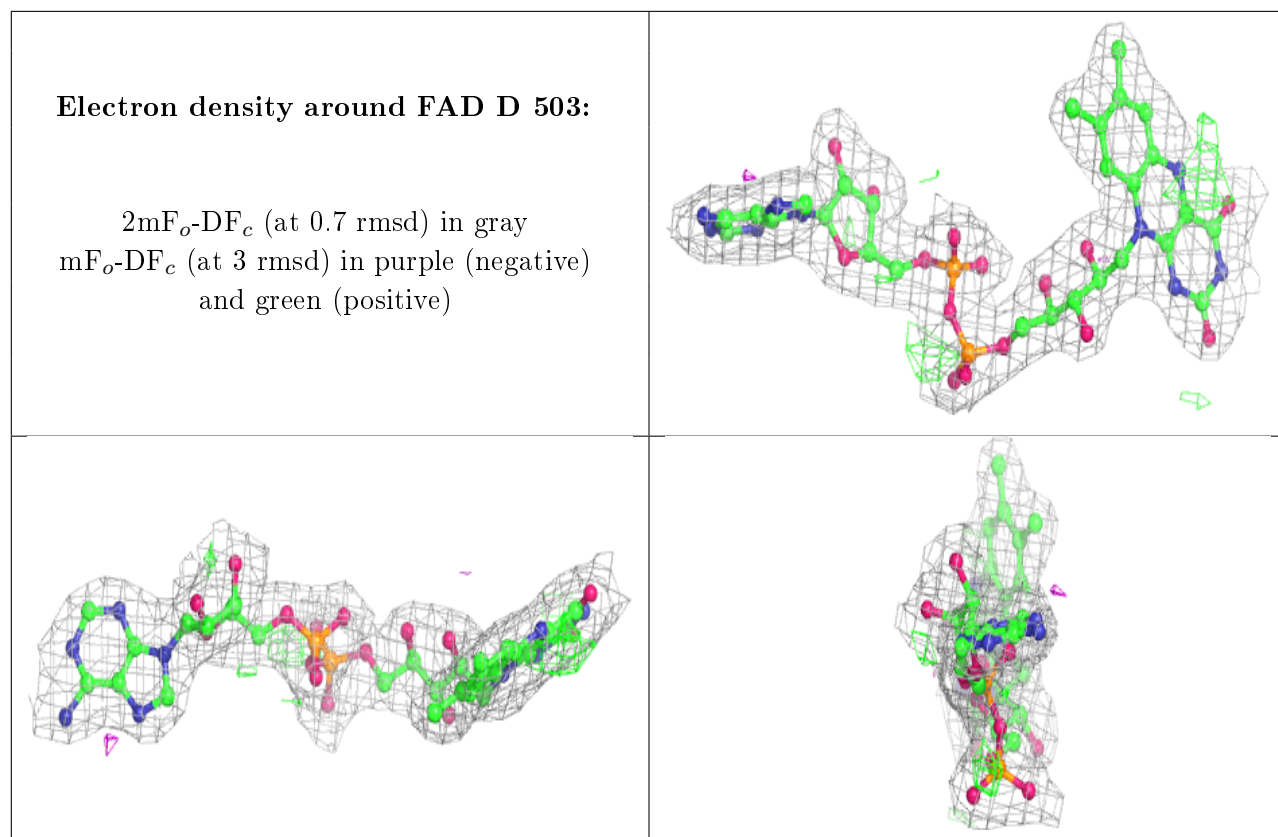

6.5 Other polymers [i](#)

There are no such residues in this entry.