



Full wwPDB X-ray Structure Validation Report ⓘ

Feb 21, 2024 – 08:11 AM EST

PDB ID : 4XAJ
Title : Crystal structure of human NR2E1/TLX
Authors : Zhi, X.; Zhou, E.; Xu, E.
Deposited on : 2014-12-14
Resolution : 3.55 Å(reported)

This is a Full wwPDB X-ray Structure Validation Report for a publicly released PDB entry.

We welcome your comments at validation@mail.wwpdb.org

A user guide is available at

<https://www.wwpdb.org/validation/2017/XrayValidationReportHelp>

with specific help available everywhere you see the ⓘ symbol.

The types of validation reports are described at

<http://www.wwpdb.org/validation/2017/FAQs#types>.

The following versions of software and data (see [references ⓘ](#)) were used in the production of this report:

MolProbity : 4.02b-467
Mogul : 1.8.5 (274361), CSD as541be (2020)
Xtriage (Phenix) : 1.13
EDS : 2.36
Percentile statistics : 20191225.v01 (using entries in the PDB archive December 25th 2019)
Refmac : 5.8.0158
CCP4 : 7.0.044 (Gargrove)
Ideal geometry (proteins) : Engh & Huber (2001)
Ideal geometry (DNA, RNA) : Parkinson et al. (1996)
Validation Pipeline (wwPDB-VP) : 2.36

1 Overall quality at a glance i

The following experimental techniques were used to determine the structure:

X-RAY DIFFRACTION

The reported resolution of this entry is 3.55 Å.

Percentile scores (ranging between 0-100) for global validation metrics of the entry are shown in the following graphic. The table shows the number of entries on which the scores are based.

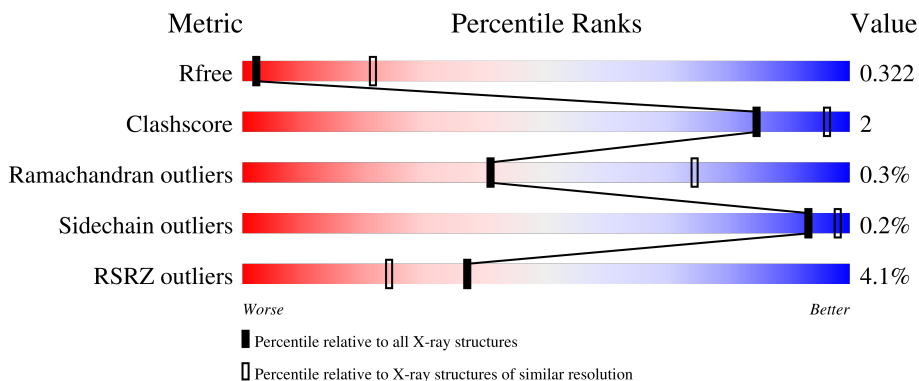



Metric	Whole archive (#Entries)	Similar resolution (#Entries, resolution range(Å))
R_{free}	130704	1020 (3.62-3.50)
Clashscore	141614	1100 (3.62-3.50)
Ramachandran outliers	138981	1065 (3.62-3.50)
Sidechain outliers	138945	1066 (3.62-3.50)
RSRZ outliers	127900	1009 (3.64-3.48)

The table below summarises the geometric issues observed across the polymeric chains and their fit to the electron density. The red, orange, yellow and green segments of the lower bar indicate the fraction of residues that contain outliers for ≥ 3 , 2, 1 and 0 types of geometric quality criteria respectively. A grey segment represents the fraction of residues that are not modelled. The numeric value for each fraction is indicated below the corresponding segment, with a dot representing fractions $\leq 5\%$. The upper red bar (where present) indicates the fraction of residues that have poor fit to the electron density. The numeric value is given above the bar.

Mol	Chain	Length	Quality of chain
1	A	576	 2% 91% 7%
1	B	576	 0% 96%
1	C	576	 3% 93% 6%
1	D	576	 10% 94% 5%
2	P	18	 6% 100%

Continued on next page...

Continued from previous page...

Mol	Chain	Length	Quality of chain
2	Q	18	 89% 11%
3	E	2	 50% 50%
3	F	2	 50% 50%
3	G	2	 50% 50%
3	H	2	 100%

The following table lists non-polymeric compounds, carbohydrate monomers and non-standard residues in protein, DNA, RNA chains that are outliers for geometric or electron-density-fit criteria:

Mol	Type	Chain	Res	Chirality	Geometry	Clashes	Electron density
3	GLC	F	2	-	-	X	-
3	GLC	H	1	-	-	X	-
3	GLC	H	2	-	-	-	X

2 Entry composition i

There are 3 unique types of molecules in this entry. The entry contains 18097 atoms, of which 0 are hydrogens and 0 are deuteriums.

In the tables below, the ZeroOcc column contains the number of atoms modelled with zero occupancy, the AltConf column contains the number of residues with at least one atom in alternate conformation and the Trace column contains the number of residues modelled with at most 2 atoms.

- Molecule 1 is a protein called Maltose-binding periplasmic protein, Nuclear receptor subfamily 2 group E member 1.

Mol	Chain	Residues	Atoms					ZeroOcc	AltConf	Trace
			Total	C	N	O	S			
1	A	568	4424	2847	729	835	13	0	0	0
1	C	568	4424	2848	729	834	13	0	0	0
1	B	570	4437	2856	731	836	14	0	0	0
1	D	568	4424	2848	729	834	13	0	0	0

There are 44 discrepancies between the modelled and reference sequences:

Chain	Residue	Modelled	Actual	Comment	Reference
A	1	MET	-	initiating methionine	UNP P0AEY0
A	369	ASN	-	linker	UNP P0AEY0
A	370	ALA	-	linker	UNP P0AEY0
A	371	ALA	-	linker	UNP P0AEY0
A	372	ALA	-	linker	UNP P0AEY0
A	373	GLU	-	linker	UNP P0AEY0
A	374	PHE	-	linker	UNP P0AEY0
A	1257	ARG	LYS	engineered mutation	UNP Q9Y466
A	1259	THR	ASN	engineered mutation	UNP Q9Y466
A	1260	LEU	LYS	engineered mutation	UNP Q9Y466
A	1338	VAL	CYS	engineered mutation	UNP Q9Y466
B	1	MET	-	initiating methionine	UNP P0AEY0
B	369	ASN	-	linker	UNP P0AEY0
B	370	ALA	-	linker	UNP P0AEY0
B	371	ALA	-	linker	UNP P0AEY0
B	372	ALA	-	linker	UNP P0AEY0
B	373	GLU	-	linker	UNP P0AEY0
B	374	PHE	-	linker	UNP P0AEY0
B	1257	ARG	LYS	engineered mutation	UNP Q9Y466
B	1259	THR	ASN	engineered mutation	UNP Q9Y466

Continued on next page...

Continued from previous page...

Chain	Residue	Modelled	Actual	Comment	Reference
B	1260	LEU	LYS	engineered mutation	UNP Q9Y466
B	1338	VAL	CYS	engineered mutation	UNP Q9Y466
C	1	MET	-	initiating methionine	UNP P0AEY0
C	369	ASN	-	linker	UNP P0AEY0
C	370	ALA	-	linker	UNP P0AEY0
C	371	ALA	-	linker	UNP P0AEY0
C	372	ALA	-	linker	UNP P0AEY0
C	373	GLU	-	linker	UNP P0AEY0
C	374	PHE	-	linker	UNP P0AEY0
C	1257	ARG	LYS	engineered mutation	UNP Q9Y466
C	1259	THR	ASN	engineered mutation	UNP Q9Y466
C	1260	LEU	LYS	engineered mutation	UNP Q9Y466
C	1338	VAL	CYS	engineered mutation	UNP Q9Y466
D	1	MET	-	initiating methionine	UNP P0AEY0
D	369	ASN	-	linker	UNP P0AEY0
D	370	ALA	-	linker	UNP P0AEY0
D	371	ALA	-	linker	UNP P0AEY0
D	372	ALA	-	linker	UNP P0AEY0
D	373	GLU	-	linker	UNP P0AEY0
D	374	PHE	-	linker	UNP P0AEY0
D	1257	ARG	LYS	engineered mutation	UNP Q9Y466
D	1259	THR	ASN	engineered mutation	UNP Q9Y466
D	1260	LEU	LYS	engineered mutation	UNP Q9Y466
D	1338	VAL	CYS	engineered mutation	UNP Q9Y466

- Molecule 2 is a protein called Atrophin/grunge.

Mol	Chain	Residues	Atoms				ZeroOcc	AltConf	Trace
2	Q	18	Total	C	N	O	0	0	0
			148	93	27	28			
2	P	18	Total	C	N	O	0	0	0
			148	93	27	28			

- Molecule 3 is an oligosaccharide called alpha-D-glucopyranose-(1-4)-alpha-D-glucopyranose.



Mol	Chain	Residues	Atoms			ZeroOcc	AltConf	Trace
3	E	2	Total	C	O	0	0	0
			23	12	11			

Continued on next page...

Continued from previous page...

Mol	Chain	Residues	Atoms			ZeroOcc	AltConf	Trace
3	F	2	Total	C	O	0	0	0
			23	12	11			
3	G	2	Total	C	O	0	0	0
			23	12	11			
3	H	2	Total	C	O	0	0	0
			23	12	11			

3 Residue-property plots [i](#)

These plots are drawn for all protein, RNA, DNA and oligosaccharide chains in the entry. The first graphic for a chain summarises the proportions of the various outlier classes displayed in the second graphic. The second graphic shows the sequence view annotated by issues in geometry and electron density. Residues are color-coded according to the number of geometric quality criteria for which they contain at least one outlier: green = 0, yellow = 1, orange = 2 and red = 3 or more. A red dot above a residue indicates a poor fit to the electron density ($RSRZ > 2$). Stretches of 2 or more consecutive residues without any outlier are shown as a green connector. Residues present in the sample, but not in the model, are shown in grey.

- Molecule 1: Maltose-binding periplasmic protein,Nuclear receptor subfamily 2 group E member 1

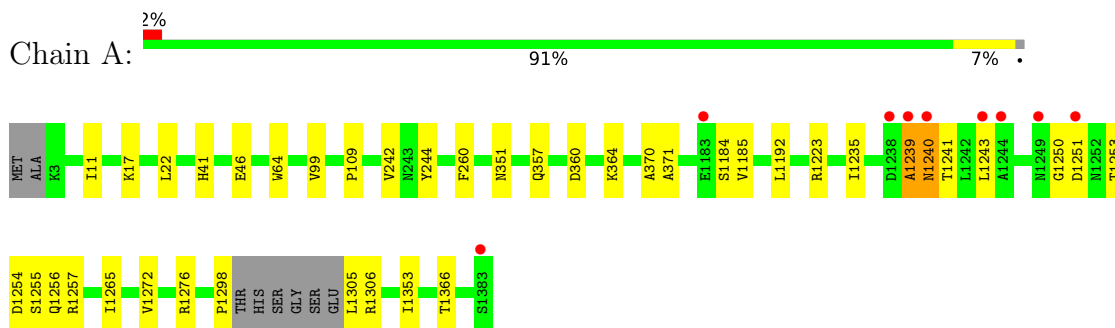

- Molecule 1: Maltose-binding periplasmic protein,Nuclear receptor subfamily 2 group E member 1

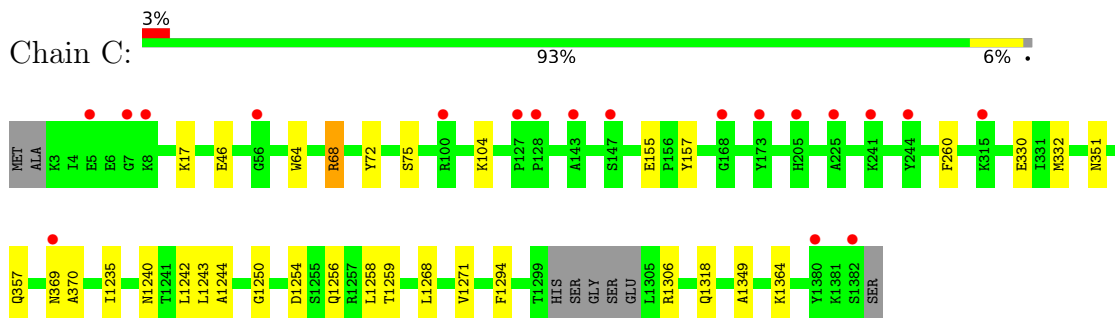

- Molecule 1: Maltose-binding periplasmic protein,Nuclear receptor subfamily 2 group E member 1

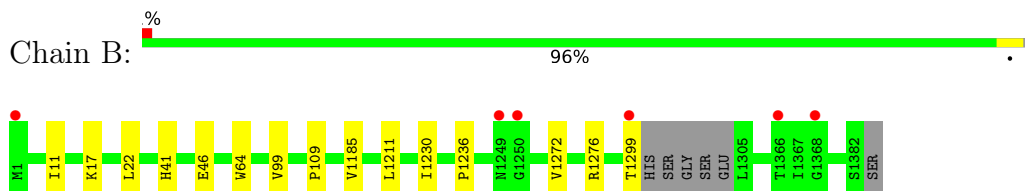

- Molecule 1: Maltose-binding periplasmic protein,Nuclear receptor subfamily 2 group E member 1



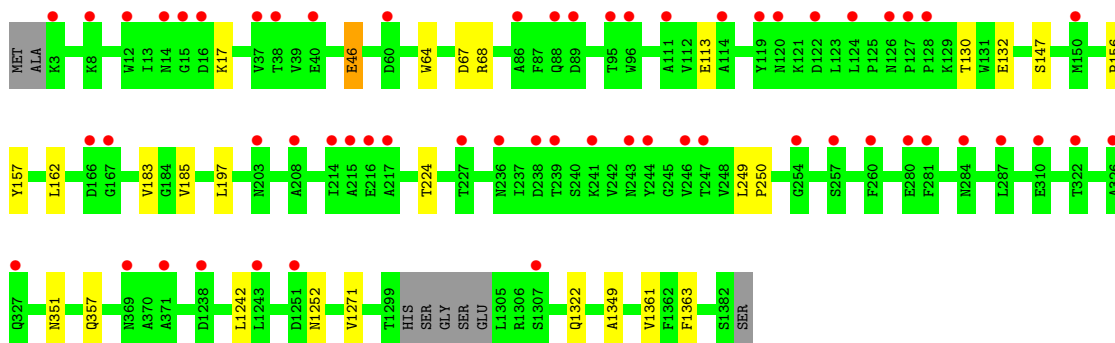

- Molecule 2: Atrophin/grunge

Chain Q: 89% 11%

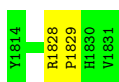

- Molecule 2: Atrophin/grunge

Chain P: 6% 100%



- Molecule 3: alpha-D-glucopyranose-(1-4)-alpha-D-glucopyranose

Chain E: 50% 50%



- Molecule 3: alpha-D-glucopyranose-(1-4)-alpha-D-glucopyranose

Chain F: 50% 50%



- Molecule 3: alpha-D-glucopyranose-(1-4)-alpha-D-glucopyranose

Chain G: 50% 50%



- Molecule 3: alpha-D-glucopyranose-(1-4)-alpha-D-glucopyranose

Chain H: 100%

GLC1
GLC2

4 Data and refinement statistics

Property	Value	Source
Space group	P 21 21 21	Depositor
Cell constants a, b, c, α , β , γ	72.26Å 130.74Å 308.52Å 90.00° 90.00° 90.00°	Depositor
Resolution (Å)	39.90 – 3.55 39.90 – 3.55	Depositor EDS
% Data completeness (in resolution range)	97.8 (39.90-3.55) 98.0 (39.90-3.55)	Depositor EDS
R_{merge}	(Not available)	Depositor
R_{sym}	(Not available)	Depositor
$\langle I/\sigma(I) \rangle$ ¹	2.88 (at 3.57Å)	Xtrriage
Refinement program	PHENIX (phenix.refine: 1.9_1692)	Depositor
R, R_{free}	0.273 , 0.314 0.277 , 0.322	Depositor DCC
R_{free} test set	2529 reflections (7.12%)	wwPDB-VP
Wilson B-factor (Å ²)	58.9	Xtrriage
Anisotropy	0.150	Xtrriage
Bulk solvent k_{sol} (e/Å ³), B_{sol} (Å ²)	0.28 , 32.9	EDS
L-test for twinning ²	$\langle L \rangle = 0.51$, $\langle L^2 \rangle = 0.35$	Xtrriage
Estimated twinning fraction	No twinning to report.	Xtrriage
F_o, F_c correlation	0.89	EDS
Total number of atoms	18097	wwPDB-VP
Average B, all atoms (Å ²)	65.0	wwPDB-VP

Xtrriage's analysis on translational NCS is as follows: *The analyses of the Patterson function reveals a significant off-origin peak that is 51.47 % of the origin peak, indicating pseudo-translational symmetry. The chance of finding a peak of this or larger height randomly in a structure without pseudo-translational symmetry is equal to 5.5865e-05. The detected translational NCS is most likely also responsible for the elevated intensity ratio.*

¹Intensities estimated from amplitudes.

²Theoretical values of $\langle |L| \rangle$, $\langle L^2 \rangle$ for acentric reflections are 0.5, 0.333 respectively for untwinned datasets, and 0.375, 0.2 for perfectly twinned datasets.

5 Model quality [i](#)

5.1 Standard geometry [i](#)

Bond lengths and bond angles in the following residue types are not validated in this section: GLC

The Z score for a bond length (or angle) is the number of standard deviations the observed value is removed from the expected value. A bond length (or angle) with $|Z| > 5$ is considered an outlier worth inspection. RMSZ is the root-mean-square of all Z scores of the bond lengths (or angles).

Mol	Chain	Bond lengths		Bond angles	
		RMSZ	# Z >5	RMSZ	# Z >5
1	A	0.35	0/4521	0.67	1/6137 (0.0%)
1	B	0.34	0/4534	0.67	0/6156
1	C	0.34	0/4521	0.66	1/6139 (0.0%)
1	D	0.33	0/4521	0.67	2/6139 (0.0%)
2	P	0.30	0/152	0.70	0/206
2	Q	0.30	0/152	0.65	0/206
All	All	0.34	0/18401	0.67	4/24983 (0.0%)

Chiral center outliers are detected by calculating the chiral volume of a chiral center and verifying if the center is modelled as a planar moiety or with the opposite hand. A planarity outlier is detected by checking planarity of atoms in a peptide group, atoms in a mainchain group or atoms of a sidechain that are expected to be planar.

Mol	Chain	#Chirality outliers	#Planarity outliers
1	A	0	1

There are no bond length outliers.

All (4) bond angle outliers are listed below:

Mol	Chain	Res	Type	Atoms	Z	Observed(°)	Ideal(°)
1	A	1250	GLY	N-CA-C	5.57	127.03	113.10
1	D	1252	ASN	N-CA-C	5.41	125.60	111.00
1	C	1235	ILE	N-CA-C	-5.39	96.46	111.00
1	D	1322	GLN	CA-CB-CG	5.09	124.61	113.40

There are no chirality outliers.

All (1) planarity outliers are listed below:

Mol	Chain	Res	Type	Group
1	A	370	ALA	Peptide

5.2 Too-close contacts [i](#)

In the following table, the Non-H and H(model) columns list the number of non-hydrogen atoms and hydrogen atoms in the chain respectively. The H(added) column lists the number of hydrogen atoms added and optimized by MolProbity. The Clashes column lists the number of clashes within the asymmetric unit, whereas Symm-Clashes lists symmetry-related clashes.

Mol	Chain	Non-H	H(model)	H(added)	Clashes	Symm-Clashes
1	A	4424	0	4442	22	0
1	B	4437	0	4461	9	0
1	C	4424	0	4444	28	0
1	D	4424	0	4444	22	0
2	P	148	0	140	0	0
2	Q	148	0	140	1	0
3	E	23	0	21	1	0
3	F	23	0	21	7	0
3	G	23	0	21	1	0
3	H	23	0	21	10	0
All	All	18097	0	18155	82	0

The all-atom clashscore is defined as the number of clashes found per 1000 atoms (including hydrogen atoms). The all-atom clashscore for this structure is 2.

All (82) close contacts within the same asymmetric unit are listed below, sorted by their clash magnitude.

Atom-1	Atom-2	Interatomic distance (Å)	Clash overlap (Å)
1:C:64:TRP:HZ2	3:F:2:GLC:H3	1.27	0.96
1:D:67:ASP:OD2	3:H:2:GLC:O3	1.96	0.83
1:C:64:TRP:CZ2	3:F:2:GLC:H3	2.15	0.80
1:A:1255:SER:OG	1:A:1256:GLN:N	2.17	0.76
1:C:17:LYS:NZ	3:F:1:GLC:O2	2.15	0.73
1:C:1306:ARG:HA	1:C:1306:ARG:NE	2.05	0.71
1:D:157:TYR:HB2	3:H:2:GLC:O5	1.95	0.67
1:A:17:LYS:NZ	3:E:1:GLC:O2	2.23	0.65
1:D:46:GLU:HG2	1:D:64:TRP:CH2	2.33	0.64
1:C:68:ARG:HB2	1:C:68:ARG:HH11	1.63	0.64
1:A:364:LYS:HA	1:A:364:LYS:HE2	1.82	0.61
1:C:104:LYS:NZ	1:C:1254:ASP:OD2	2.31	0.61
1:C:46:GLU:OE2	3:F:2:GLC:O4	2.19	0.60

Continued on next page...

Continued from previous page...

Atom-1	Atom-2	Interatomic distance (Å)	Clash overlap (Å)
1:D:157:TYR:CD2	3:H:1:GLC:H61	2.38	0.59
1:A:41:HIS:ND1	1:A:41:HIS:O	2.41	0.54
1:C:75:SER:HB3	1:C:1244:ALA:HB1	1.90	0.53
1:A:1255:SER:HB3	1:A:1257:ARG:H	1.74	0.53
1:A:1257:ARG:O	1:A:1257:ARG:HG2	2.07	0.53
1:A:1240:ASN:N	1:A:1241:THR:HA	2.24	0.52
1:C:68:ARG:HD3	1:C:72:TYR:CZ	2.45	0.52
1:D:183:VAL:HG22	1:D:185:VAL:H	1.75	0.52
1:D:351:ASN:HB3	1:D:357:GLN:HG2	1.92	0.52
1:D:113:GLU:OE1	3:H:1:GLC:O2	2.24	0.52
1:D:130:THR:OG1	1:D:132:GLU:OE1	2.28	0.51
1:C:260:PHE:HB3	1:C:332:MET:CG	2.40	0.51
1:A:1223:ARG:NH1	1:A:1353:ILE:O	2.45	0.50
1:A:1241:THR:HG21	1:A:1265:ILE:HG22	1.93	0.50
1:C:68:ARG:HD3	1:C:72:TYR:CE1	2.46	0.50
1:B:1230:ILE:HG23	1:B:1236:PRO:HD2	1.94	0.49
1:D:1271:VAL:HG22	1:D:1349:ALA:HB1	1.94	0.49
1:A:1272:VAL:O	1:A:1276:ARG:HG2	2.14	0.47
1:C:369:ASN:OD1	1:C:370:ALA:N	2.48	0.47
1:C:1294:PHE:O	1:C:1318:GLN:HB2	2.15	0.46
1:A:1298:PRO:HB2	1:A:1305:LEU:HB2	1.97	0.46
1:D:147:SER:HB3	1:D:224:THR:HG22	1.98	0.46
1:C:260:PHE:HB3	1:C:332:MET:HG3	1.98	0.46
1:C:1256:GLN:O	1:C:1259:THR:N	2.45	0.46
1:C:68:ARG:HD3	1:C:72:TYR:OH	2.16	0.46
1:C:1271:VAL:HG22	1:C:1349:ALA:HB1	1.98	0.45
1:D:157:TYR:CE1	3:H:1:GLC:H4	2.51	0.45
1:C:1306:ARG:HA	1:C:1306:ARG:HE	1.81	0.45
1:D:156:PRO:HG2	3:H:2:GLC:H61	1.99	0.45
1:C:155:GLU:HB3	3:F:2:GLC:O6	2.17	0.45
1:D:1242:LEU:HD12	1:D:1242:LEU:HA	1.71	0.45
1:A:1253:THR:OG1	1:A:1254:ASP:N	2.49	0.45
1:D:17:LYS:HZ3	3:H:1:GLC:C1	2.30	0.45
1:D:162:LEU:HD23	1:D:197:LEU:HG	1.97	0.45
1:B:17:LYS:NZ	3:G:1:GLC:O2	2.25	0.45
1:D:157:TYR:CD1	3:H:1:GLC:H4	2.51	0.44
1:C:260:PHE:HA	1:C:330:GLU:O	2.18	0.44
1:A:1239:ALA:HB1	1:A:1243:LEU:HB3	2.00	0.44
1:A:1184:SER:OG	1:A:1185:VAL:N	2.50	0.44
1:B:41:HIS:O	1:B:41:HIS:ND1	2.51	0.44
1:C:155:GLU:HB3	3:F:2:GLC:HO6	1.82	0.43

Continued on next page...

Continued from previous page...

Atom-1	Atom-2	Interatomic distance (Å)	Clash overlap (Å)
1:C:1256:GLN:C	1:C:1258:LEU:N	2.72	0.43
1:A:242:VAL:HG12	1:A:244:TYR:HB3	2.00	0.43
1:D:17:LYS:NZ	3:H:1:GLC:C1	2.82	0.43
1:D:147:SER:O	1:D:224:THR:HA	2.18	0.43
1:A:99:VAL:HG21	1:A:109:PRO:HD3	1.99	0.43
1:C:157:TYR:HB2	3:F:2:GLC:O5	2.19	0.43
1:C:260:PHE:HB3	1:C:332:MET:HG2	2.00	0.43
1:D:67:ASP:OD1	1:D:68:ARG:N	2.51	0.43
1:B:1211:LEU:HD12	1:B:1211:LEU:HA	1.85	0.42
1:C:1240:ASN:HA	1:C:1243:LEU:HB2	2.01	0.42
1:D:249:LEU:HA	1:D:250:PRO:HD3	1.91	0.42
1:A:351:ASN:HB3	1:A:357:GLN:HG2	2.00	0.42
1:A:1192:LEU:HD11	1:A:1235:ILE:HD12	2.02	0.42
1:B:1299:THR:O	1:B:1299:THR:HG22	2.20	0.42
1:C:1250:GLY:HA2	1:C:1364:LYS:HB3	2.02	0.41
1:D:1242:LEU:HD11	1:D:1361:VAL:HG11	2.01	0.41
1:C:351:ASN:HB3	1:C:357:GLN:HG2	2.02	0.41
1:B:11:ILE:HG21	1:B:22:LEU:HD21	2.03	0.41
1:B:99:VAL:HG21	1:B:109:PRO:HD3	2.03	0.41
1:A:46:GLU:HG2	1:A:64:TRP:CZ2	2.55	0.41
1:B:1272:VAL:O	1:B:1276:ARG:HG2	2.20	0.41
1:A:11:ILE:HG21	1:A:22:LEU:HD21	2.03	0.41
1:D:113:GLU:OE1	3:H:1:GLC:C2	2.69	0.40
1:A:360:ASP:O	1:A:364:LYS:HG2	2.22	0.40
2:Q:1828:ARG:HB3	2:Q:1829:PRO:HD3	2.01	0.40
1:B:46:GLU:HG2	1:B:64:TRP:CZ2	2.56	0.40
1:A:1306:ARG:NE	1:A:1306:ARG:HA	2.35	0.40
1:C:1242:LEU:HD21	1:C:1268:LEU:HD23	2.02	0.40

There are no symmetry-related clashes.

5.3 Torsion angles [i](#)

5.3.1 Protein backbone [i](#)

In the following table, the Percentiles column shows the percent Ramachandran outliers of the chain as a percentile score with respect to all X-ray entries followed by that with respect to entries of similar resolution.

The Analysed column shows the number of residues for which the backbone conformation was analysed, and the total number of residues.

Mol	Chain	Analysed	Favoured	Allowed	Outliers	Percentiles	
1	A	564/576 (98%)	546 (97%)	13 (2%)	5 (1%)	17	57
1	B	566/576 (98%)	548 (97%)	17 (3%)	1 (0%)	47	80
1	C	564/576 (98%)	545 (97%)	19 (3%)	0	100	100
1	D	564/576 (98%)	544 (96%)	20 (4%)	0	100	100
2	P	16/18 (89%)	16 (100%)	0	0	100	100
2	Q	16/18 (89%)	16 (100%)	0	0	100	100
All	All	2290/2340 (98%)	2215 (97%)	69 (3%)	6 (0%)	41	74

All (6) Ramachandran outliers are listed below:

Mol	Chain	Res	Type
1	A	371	ALA
1	A	1239	ALA
1	A	1366	THR
1	B	1185	VAL
1	A	1251	ASP
1	A	1240	ASN

5.3.2 Protein sidechains [i](#)

In the following table, the Percentiles column shows the percent sidechain outliers of the chain as a percentile score with respect to all X-ray entries followed by that with respect to entries of similar resolution.

The Analysed column shows the number of residues for which the sidechain conformation was analysed, and the total number of residues.

Mol	Chain	Analysed	Rotameric	Outliers	Percentiles	
1	A	466/472 (99%)	465 (100%)	1 (0%)	93	98
1	B	467/472 (99%)	467 (100%)	0	100	100
1	C	466/472 (99%)	465 (100%)	1 (0%)	93	98
1	D	466/472 (99%)	464 (100%)	2 (0%)	91	97
2	P	15/15 (100%)	15 (100%)	0	100	100
2	Q	15/15 (100%)	15 (100%)	0	100	100
All	All	1895/1918 (99%)	1891 (100%)	4 (0%)	93	98

All (4) residues with a non-rotameric sidechain are listed below:

Mol	Chain	Res	Type
1	A	260	PHE
1	C	68	ARG
1	D	46	GLU
1	D	1363	PHE

Sometimes sidechains can be flipped to improve hydrogen bonding and reduce clashes. There are no such sidechains identified.

5.3.3 RNA [i](#)

There are no RNA molecules in this entry.

5.4 Non-standard residues in protein, DNA, RNA chains [i](#)

There are no non-standard protein/DNA/RNA residues in this entry.

5.5 Carbohydrates [i](#)

8 monosaccharides are modelled in this entry.

In the following table, the Counts columns list the number of bonds (or angles) for which Mogul statistics could be retrieved, the number of bonds (or angles) that are observed in the model and the number of bonds (or angles) that are defined in the Chemical Component Dictionary. The Link column lists molecule types, if any, to which the group is linked. The Z score for a bond length (or angle) is the number of standard deviations the observed value is removed from the expected value. A bond length (or angle) with $|Z| > 2$ is considered an outlier worth inspection. RMSZ is the root-mean-square of all Z scores of the bond lengths (or angles).

Mol	Type	Chain	Res	Link	Bond lengths			Bond angles		
					Counts	RMSZ	$\# Z > 2$	Counts	RMSZ	$\# Z > 2$
3	GLC	E	1	3	12,12,12	0.57	0	17,17,17	0.70	0
3	GLC	E	2	3	11,11,12	0.63	0	15,15,17	0.81	0
3	GLC	F	1	3	12,12,12	0.56	0	17,17,17	0.85	0
3	GLC	F	2	3	11,11,12	0.74	0	15,15,17	1.05	1 (6%)
3	GLC	G	1	3	12,12,12	0.57	0	17,17,17	0.58	0
3	GLC	G	2	3	11,11,12	0.66	0	15,15,17	0.69	0
3	GLC	H	1	3	12,12,12	0.73	0	17,17,17	1.47	4 (23%)
3	GLC	H	2	3	11,11,12	0.91	0	15,15,17	1.38	2 (13%)

In the following table, the Chirals column lists the number of chiral outliers, the number of chiral centers analysed, the number of these observed in the model and the number defined in the Chemical Component Dictionary. Similar counts are reported in the Torsion and Rings columns.

'-' means no outliers of that kind were identified.

Mol	Type	Chain	Res	Link	Chirals	Torsions	Rings
3	GLC	E	1	3	-	0/2/22/22	0/1/1/1
3	GLC	E	2	3	-	0/2/19/22	0/1/1/1
3	GLC	F	1	3	-	0/2/22/22	0/1/1/1
3	GLC	F	2	3	-	0/2/19/22	0/1/1/1
3	GLC	G	1	3	-	0/2/22/22	0/1/1/1
3	GLC	G	2	3	-	0/2/19/22	0/1/1/1
3	GLC	H	1	3	-	0/2/22/22	0/1/1/1
3	GLC	H	2	3	-	0/2/19/22	0/1/1/1

There are no bond length outliers.

All (7) bond angle outliers are listed below:

Mol	Chain	Res	Type	Atoms	Z	Observed(°)	Ideal(°)
3	H	1	GLC	C1-O5-C5	-3.65	106.78	113.66
3	H	2	GLC	O5-C5-C6	3.10	112.07	107.20
3	F	2	GLC	C6-C5-C4	-2.54	107.06	113.00
3	H	1	GLC	O2-C2-C3	-2.53	104.51	110.35
3	H	2	GLC	C6-C5-C4	-2.44	107.30	113.00
3	H	1	GLC	C3-C4-C5	2.11	114.01	110.24
3	H	1	GLC	O5-C5-C6	2.06	111.56	106.44

There are no chirality outliers.

There are no torsion outliers.

There are no ring outliers.

6 monomers are involved in 19 short contacts:

Mol	Chain	Res	Type	Clashes	Symm-Clashes
3	E	1	GLC	1	0
3	H	1	GLC	7	0
3	G	1	GLC	1	0
3	F	2	GLC	6	0
3	H	2	GLC	3	0
3	F	1	GLC	1	0

The following is a two-dimensional graphical depiction of Mogul quality analysis of bond lengths, bond angles, torsion angles, and ring geometry for oligosaccharide.

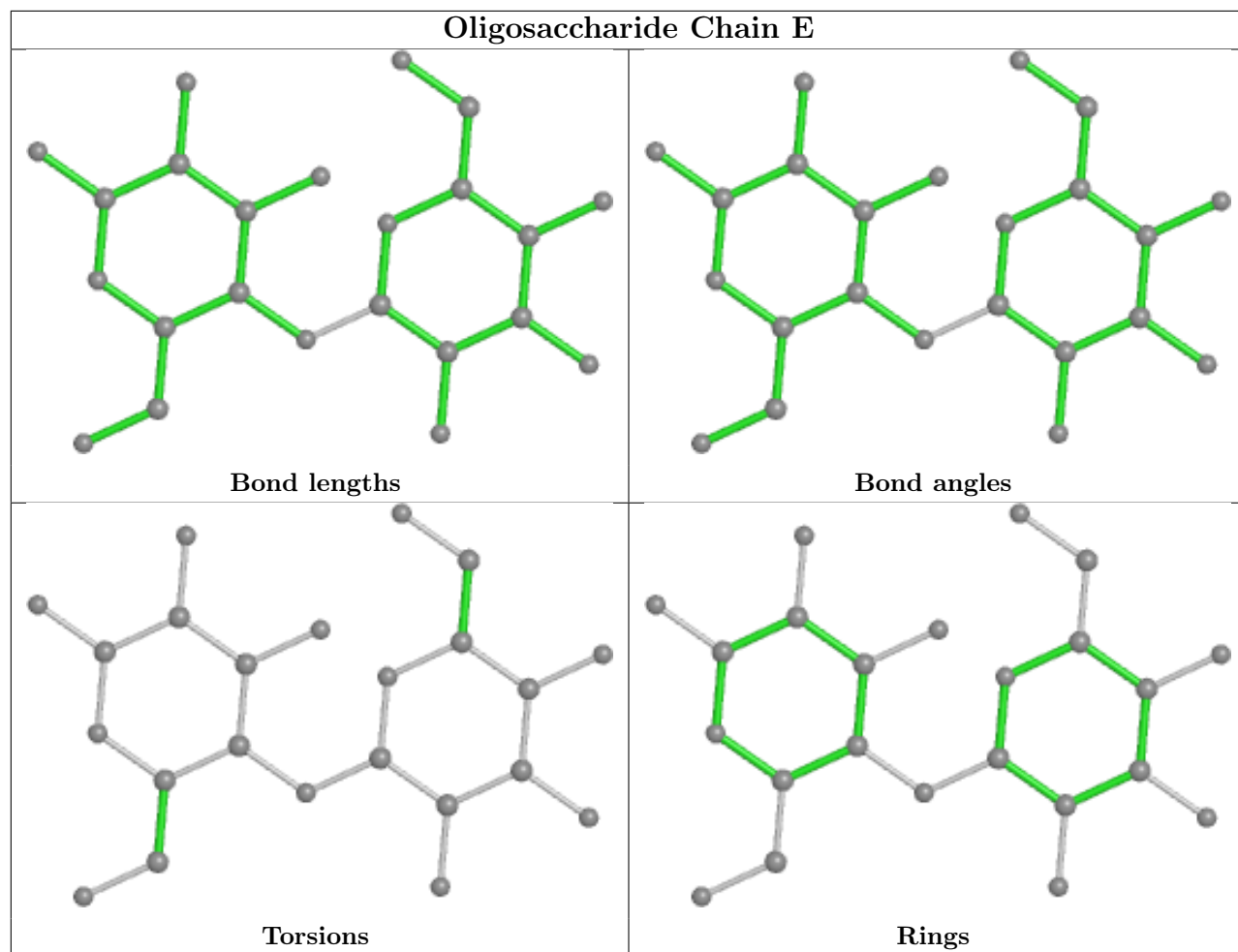

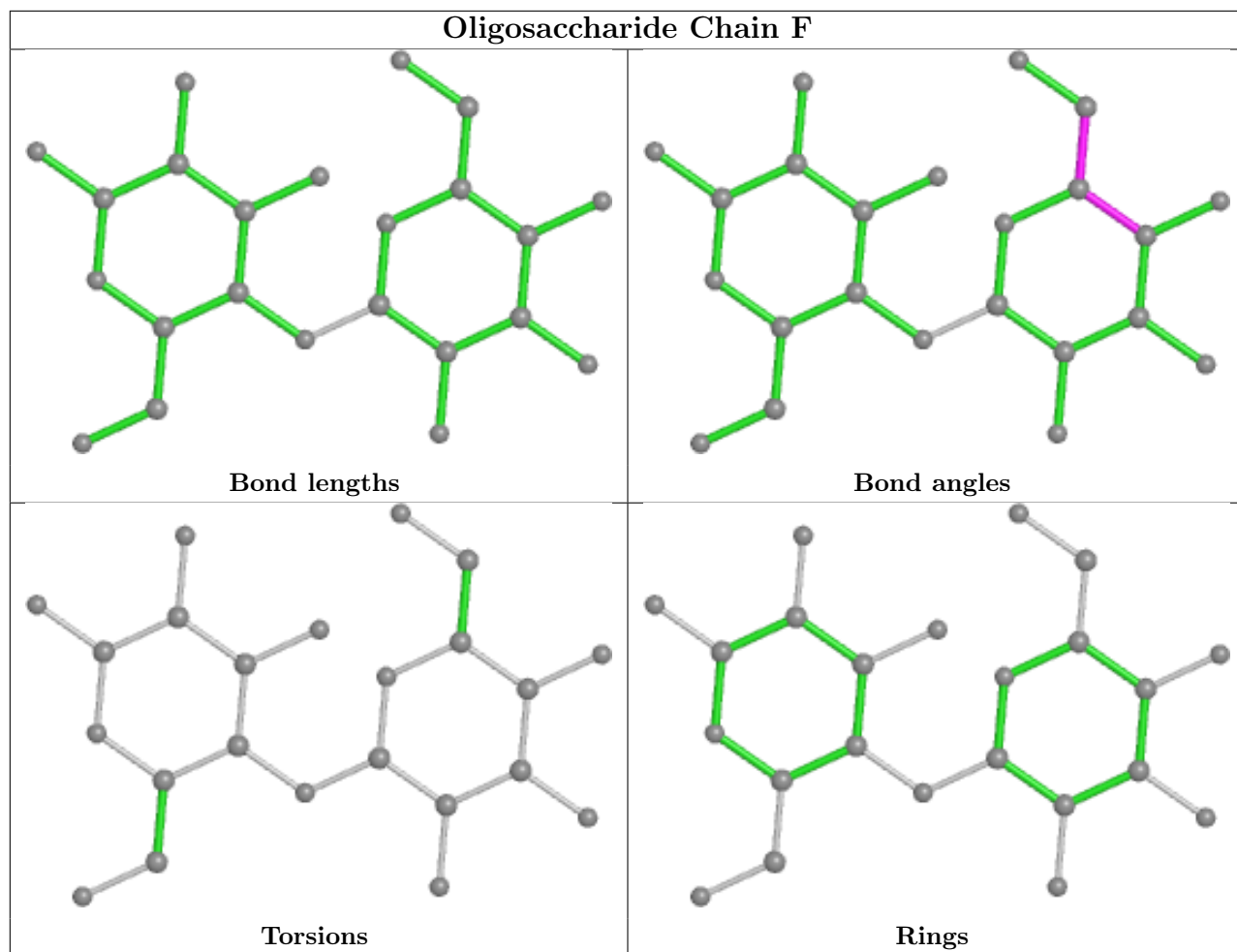

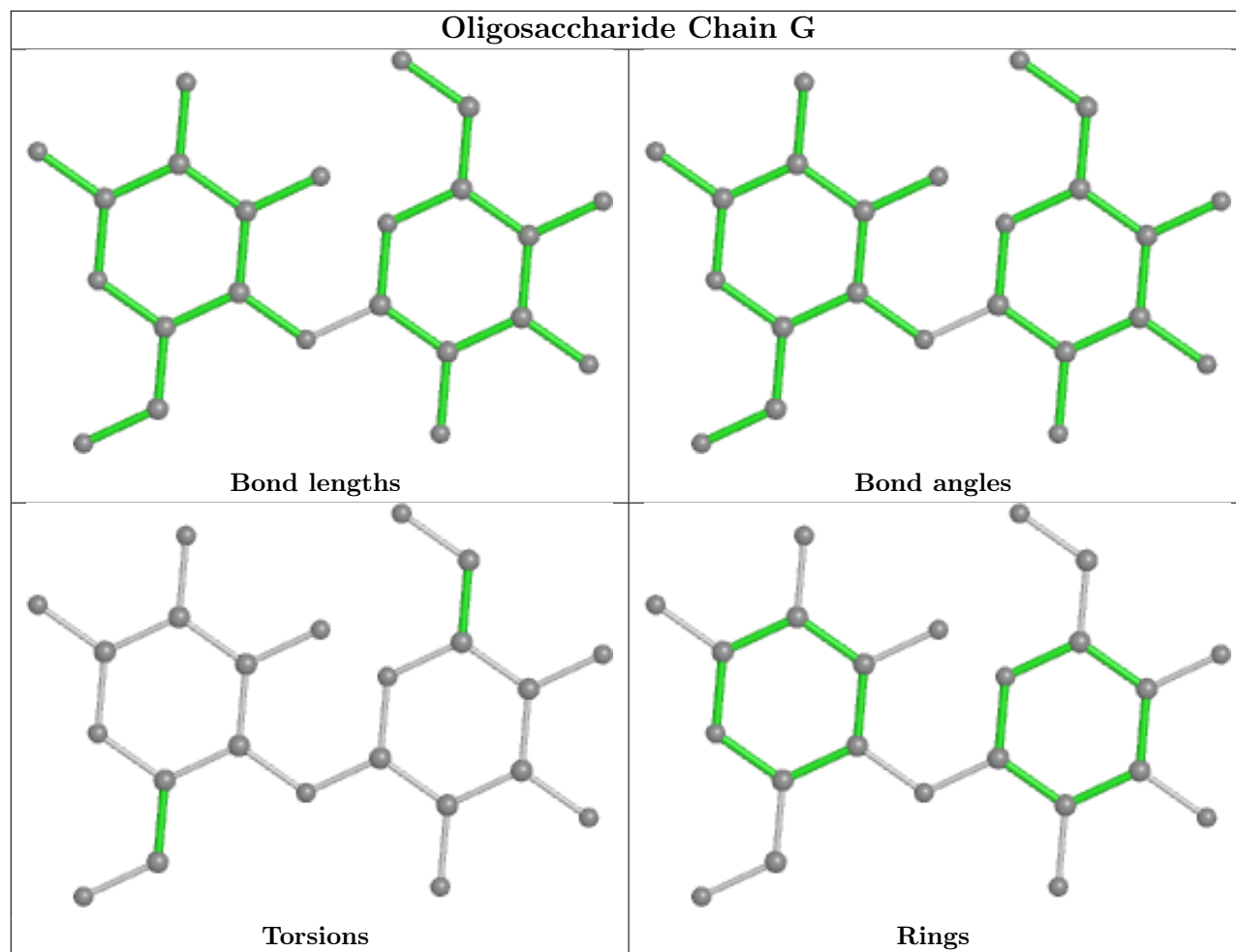

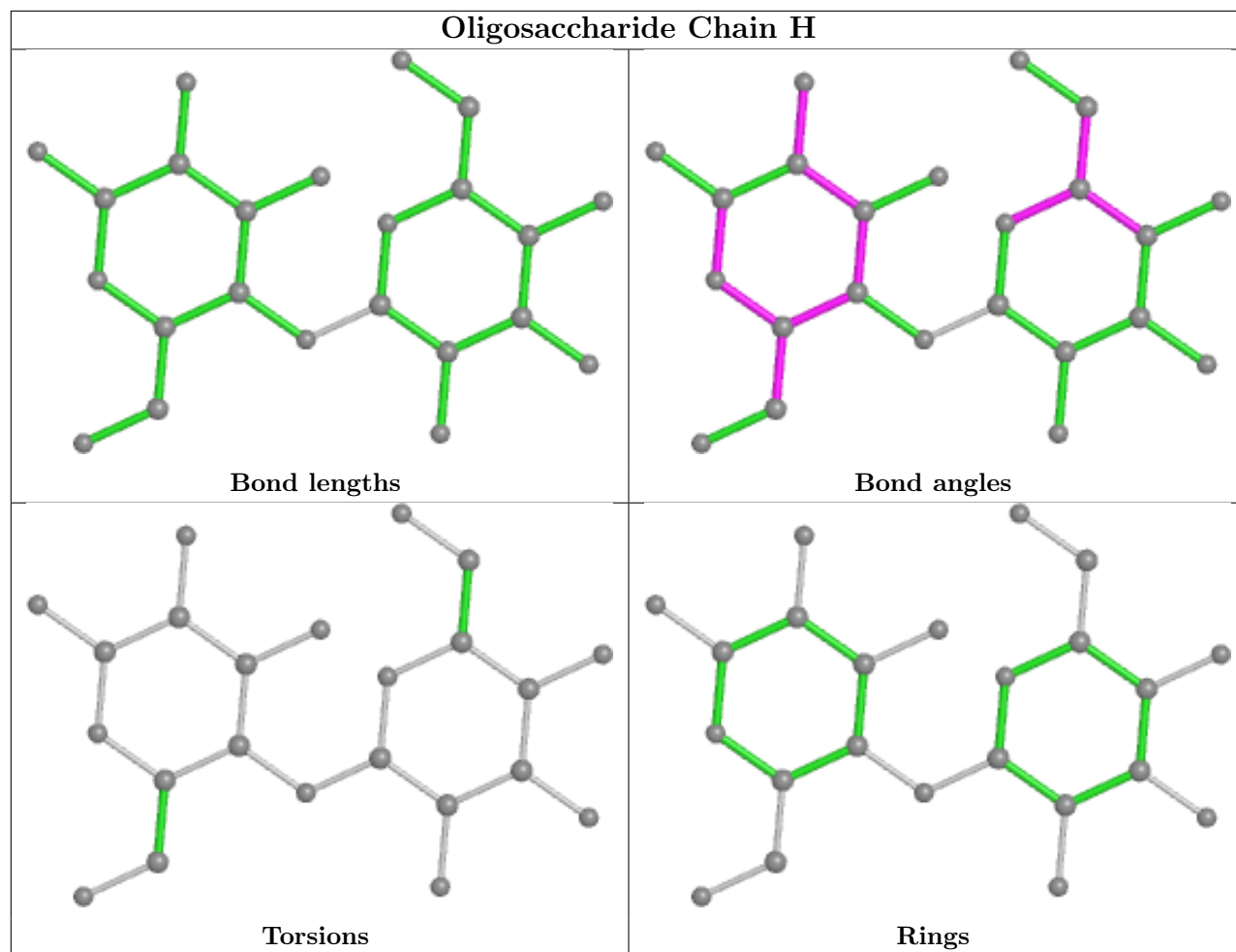

5.6 Ligand geometry [i](#)

There are no ligands in this entry.

5.7 Other polymers [i](#)

There are no such residues in this entry.

5.8 Polymer linkage issues [i](#)

There are no chain breaks in this entry.

6 Fit of model and data [i](#)

6.1 Protein, DNA and RNA chains [i](#)

In the following table, the column labelled ‘#RSRZ> 2’ contains the number (and percentage) of RSRZ outliers, followed by percent RSRZ outliers for the chain as percentile scores relative to all X-ray entries and entries of similar resolution. The OWAB column contains the minimum, median, 95th percentile and maximum values of the occupancy-weighted average B-factor per residue. The column labelled ‘Q< 0.9’ lists the number of (and percentage) of residues with an average occupancy less than 0.9.

Mol	Chain	Analysed	<RSRZ>	#RSRZ>2	OWAB(Å ²)	Q<0.9
1	A	568/576 (98%)	-0.24	9 (1%) 72 57	17, 35, 74, 96	0
1	B	570/576 (98%)	-0.25	6 (1%) 80 67	15, 35, 76, 107	0
1	C	568/576 (98%)	0.24	19 (3%) 46 32	17, 88, 122, 150	0
1	D	568/576 (98%)	0.59	59 (10%) 6 4	18, 116, 185, 210	0
2	P	18/18 (100%)	0.30	1 (5%) 24 15	57, 71, 83, 91	0
2	Q	18/18 (100%)	0.12	0 100 100	50, 63, 90, 91	0
All	All	2310/2340 (98%)	0.09	94 (4%) 37 24	15, 47, 155, 210	0

All (94) RSRZ outliers are listed below:

Mol	Chain	Res	Type	RSRZ
1	A	1244	ALA	5.1
1	A	1240	ASN	4.8
1	D	127	PRO	4.8
1	D	111	ALA	4.6
1	D	244	TYR	4.2
1	D	247	THR	4.2
1	D	287	LEU	4.0
1	D	1243	LEU	3.9
1	D	86	ALA	3.8
1	D	38	THR	3.8
1	D	227	THR	3.7
1	D	1307	SER	3.5
1	D	216	GLU	3.5
1	B	1366	THR	3.5
1	C	205	HIS	3.4
1	B	1249	ASN	3.3
1	D	241	LYS	3.3
1	D	214	ILE	3.3
1	D	280	GLU	3.3

Continued on next page...

Continued from previous page...

Mol	Chain	Res	Type	RSRZ
1	B	1368	GLY	3.3
1	D	310	GLU	3.3
1	D	120	ASN	3.3
1	D	60	ASP	3.2
1	A	1238	ASP	3.2
1	D	14	ASN	3.1
1	C	5	GLU	3.1
1	D	16	ASP	3.0
1	D	1238	ASP	3.0
1	B	1299	THR	3.0
1	D	3	LYS	3.0
1	A	1243	LEU	3.0
1	C	168	GLY	3.0
1	D	243	ASN	3.0
1	D	326	ALA	2.9
1	D	88	GLN	2.9
1	C	7	GLY	2.9
1	D	203	ASN	2.9
1	A	1239	ALA	2.8
1	D	215	ALA	2.8
1	D	284	ASN	2.8
1	D	89	ASP	2.8
1	C	127	PRO	2.7
1	A	1383	SER	2.7
1	D	119	TYR	2.7
1	D	126	ASN	2.6
1	D	167	GLY	2.6
1	D	371	ALA	2.6
1	D	246	VAL	2.6
1	D	239	THR	2.6
1	D	238	ASP	2.6
1	D	15	GLY	2.6
1	D	114	ALA	2.5
1	D	254	GLY	2.5
1	D	281	PHE	2.5
1	D	369	ASN	2.4
1	D	40	GLU	2.4
1	D	122	ASP	2.4
1	C	369	ASN	2.4
1	D	327	GLN	2.4
1	D	236	ASN	2.4
1	C	225	ALA	2.4

Continued on next page...

Continued from previous page...

Mol	Chain	Res	Type	RSRZ
1	D	128	PRO	2.3
1	D	12	TRP	2.3
1	C	173	TYR	2.3
1	C	100	ARG	2.3
1	C	143	ALA	2.3
1	C	241	LYS	2.3
1	D	322	THR	2.3
1	C	1380	TYR	2.3
1	D	95	THR	2.3
1	D	8	LYS	2.3
2	P	1814	TYR	2.3
1	C	128	PRO	2.2
1	D	166	ASP	2.2
1	D	96	TRP	2.2
1	D	37	VAL	2.2
1	D	124	LEU	2.2
1	D	208	ALA	2.2
1	D	260	PHE	2.2
1	A	1183	GLU	2.1
1	A	1249	ASN	2.1
1	C	244	TYR	2.1
1	A	1251	ASP	2.1
1	D	150	MET	2.1
1	D	217	ALA	2.1
1	D	1251	ASP	2.1
1	C	8	LYS	2.1
1	B	1	MET	2.0
1	B	1250	GLY	2.0
1	C	315	LYS	2.0
1	C	147	SER	2.0
1	C	56	GLY	2.0
1	C	1382	SER	2.0
1	D	257	SER	2.0

6.2 Non-standard residues in protein, DNA, RNA chains [\(i\)](#)

There are no non-standard protein/DNA/RNA residues in this entry.

6.3 Carbohydrates [i](#)

In the following table, the Atoms column lists the number of modelled atoms in the group and the number defined in the chemical component dictionary. The B-factors column lists the minimum, median, 95th percentile and maximum values of B factors of atoms in the group. The column labelled 'Q< 0.9' lists the number of atoms with occupancy less than 0.9.

Mol	Type	Chain	Res	Atoms	RSCC	RSR	B-factors(Å ²)	Q<0.9
3	GLC	H	2	11/12	0.46	0.53	84,90,94,94	0
3	GLC	H	1	12/12	0.65	0.38	95,100,104,104	0
3	GLC	F	2	11/12	0.73	0.35	57,60,62,62	0
3	GLC	F	1	12/12	0.82	0.29	63,66,69,69	0
3	GLC	G	2	11/12	0.93	0.21	14,15,15,16	0
3	GLC	E	2	11/12	0.95	0.17	14,15,16,16	0
3	GLC	G	1	12/12	0.96	0.15	14,16,17,17	0
3	GLC	E	1	12/12	0.96	0.13	14,15,16,17	0

The following is a graphical depiction of the model fit to experimental electron density for oligosaccharide. Each fit is shown from different orientation to approximate a three-dimensional view.

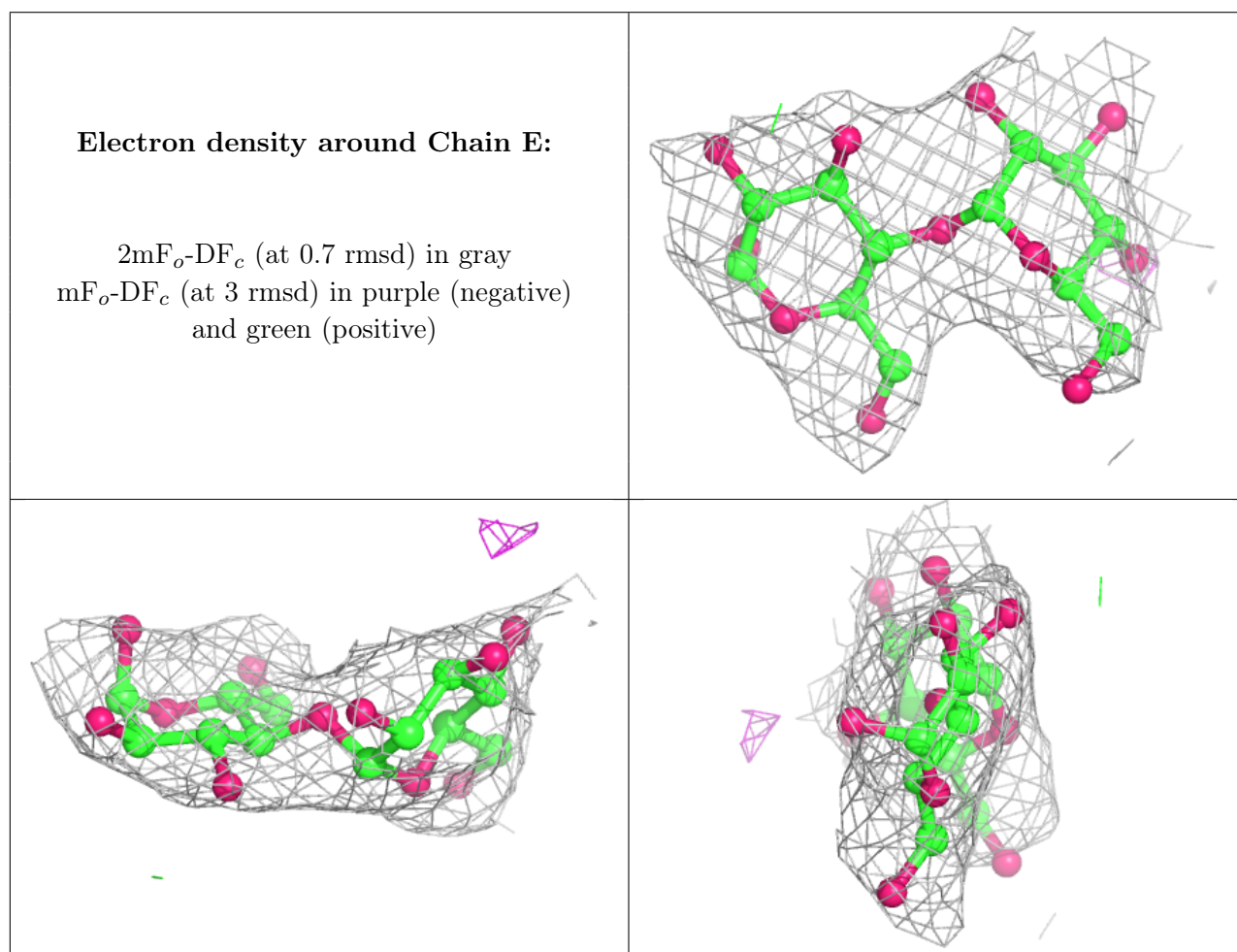

Electron density around Chain F:

$2mF_o-DF_c$ (at 0.7 rmsd) in gray
 mF_o-DF_c (at 3 rmsd) in purple (negative)
and green (positive)

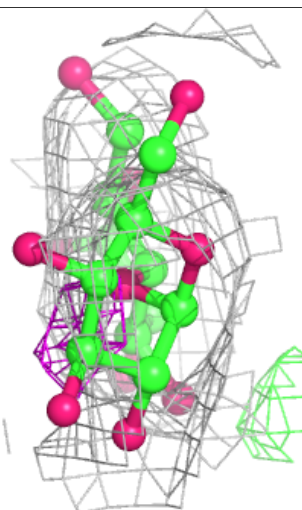
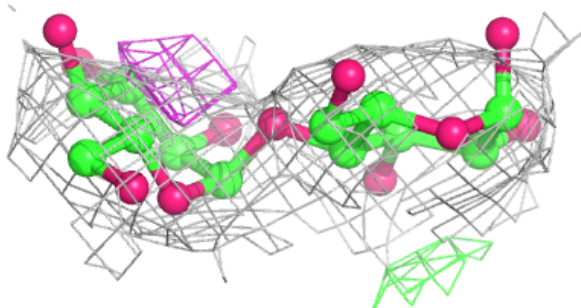
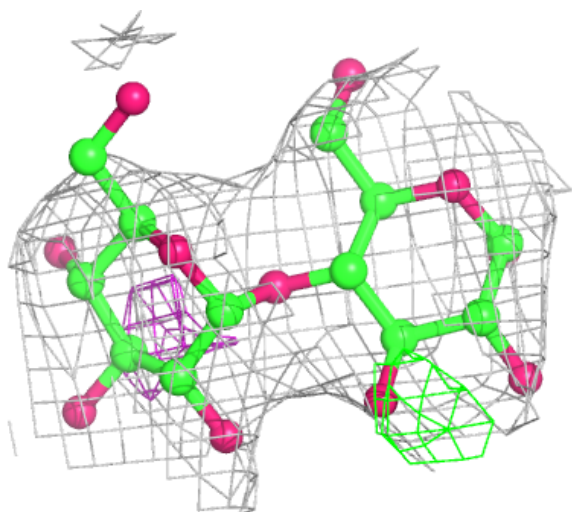

Electron density around Chain G:

$2mF_o-DF_c$ (at 0.7 rmsd) in gray
 mF_o-DF_c (at 3 rmsd) in purple (negative)
and green (positive)

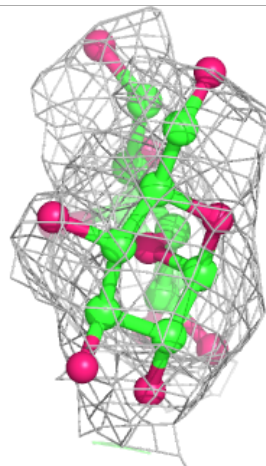
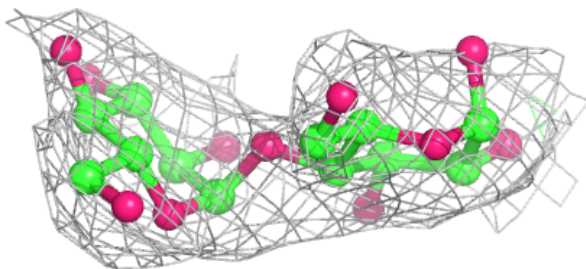
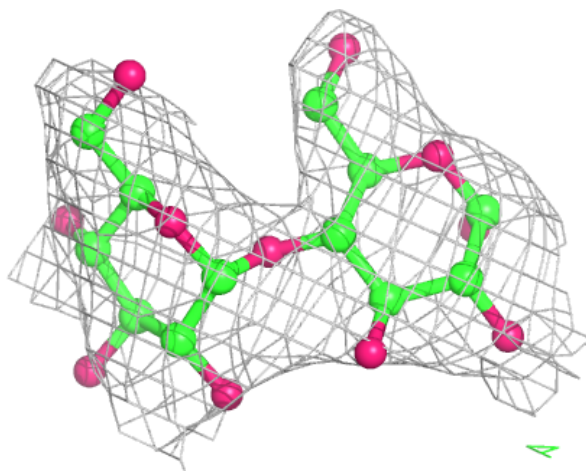

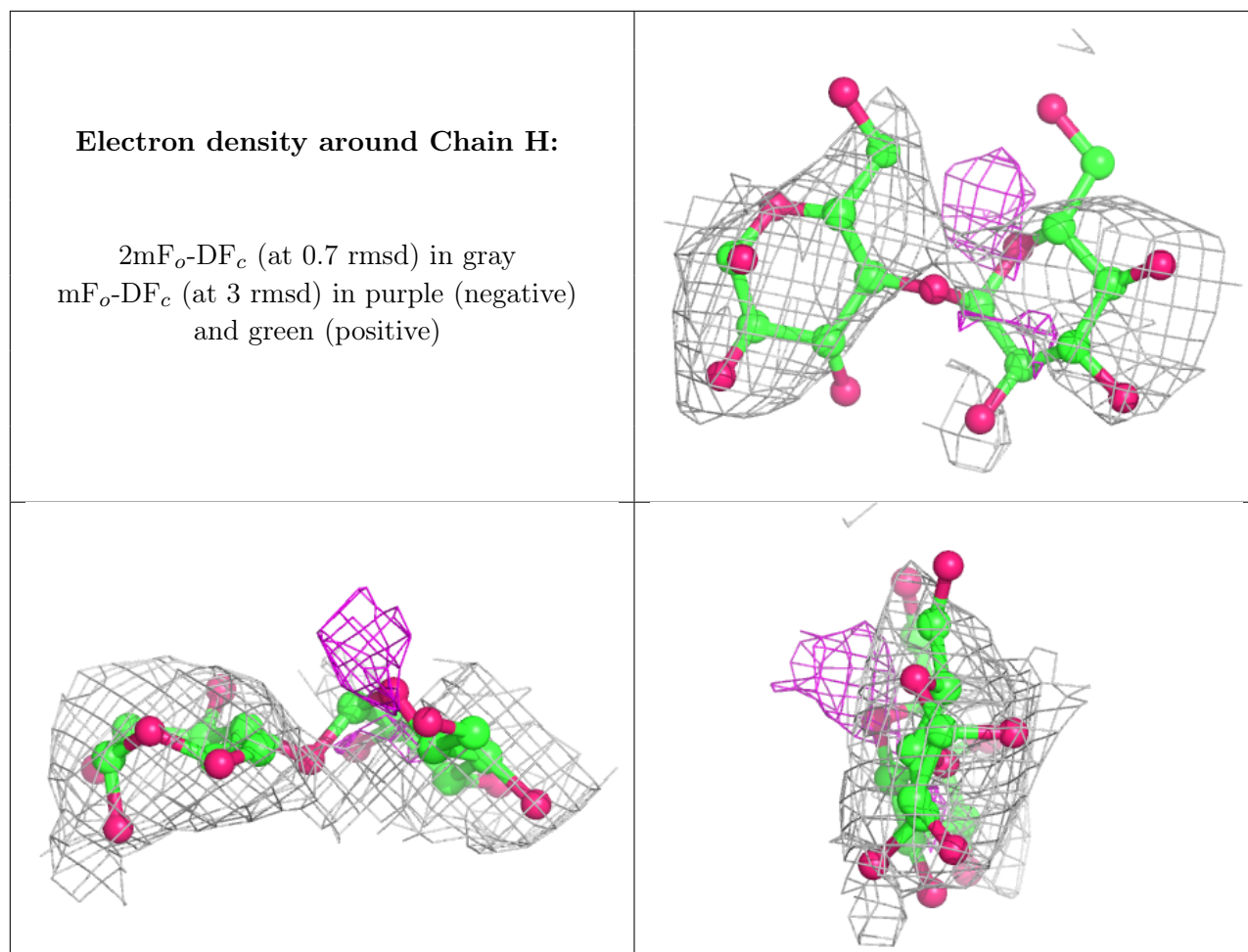

6.4 Ligands [i](#)

There are no ligands in this entry.

6.5 Other polymers [i](#)

There are no such residues in this entry.