



# wwPDB X-ray Structure Validation Summary Report ⓘ

Jun 15, 2020 – 07:06 am BST

PDB ID : 4TLV  
Title : CARDS TOXIN, NICKED  
Authors : Taylor, A.B.; Pakhomova, O.N.; Hart, P.J.  
Deposited on : 2014-05-30  
Resolution : 1.90 Å(reported)

This is a wwPDB X-ray Structure Validation Summary Report for a publicly released PDB entry.

We welcome your comments at [validation@mail.wwpdb.org](mailto:validation@mail.wwpdb.org)

A user guide is available at

<https://www.wwpdb.org/validation/2017/XrayValidationReportHelp>

with specific help available everywhere you see the ⓘ symbol.

---

The following versions of software and data (see [references ⓘ](#)) were used in the production of this report:

MolProbity : 4.02b-467  
Mogul : 1.8.5 (274361), CSD as541be (2020)  
Xtriage (Phenix) : 1.13  
EDS : 2.11  
Percentile statistics : 20191225.v01 (using entries in the PDB archive December 25th 2019)  
Refmac : 5.8.0158  
CCP4 : 7.0.044 (Gargrove)  
Ideal geometry (proteins) : Engh & Huber (2001)  
Ideal geometry (DNA, RNA) : Parkinson et al. (1996)  
Validation Pipeline (wwPDB-VP) : 2.11

# 1 Overall quality at a glance

The following experimental techniques were used to determine the structure:  
*X-RAY DIFFRACTION*

The reported resolution of this entry is 1.90 Å.

Percentile scores (ranging between 0-100) for global validation metrics of the entry are shown in the following graphic. The table shows the number of entries on which the scores are based.

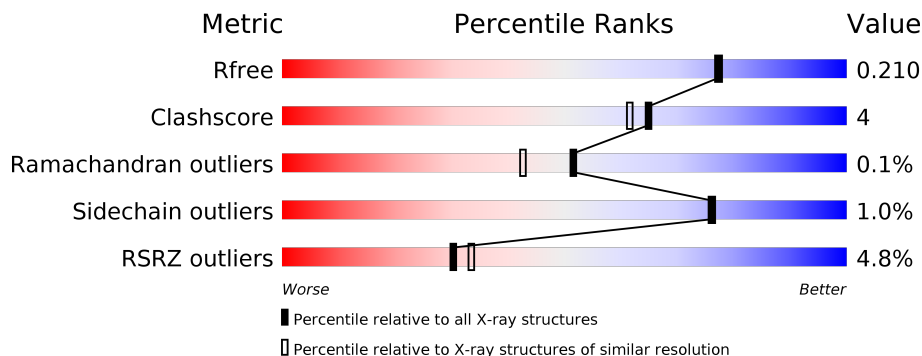

Metric	Whole archive (#Entries)	Similar resolution (#Entries, resolution range(Å))
$R_{free}$	130704	6207 (1.90-1.90)
Clashscore	141614	6847 (1.90-1.90)
Ramachandran outliers	138981	6760 (1.90-1.90)
Sidechain outliers	138945	6760 (1.90-1.90)
RSRZ outliers	127900	6082 (1.90-1.90)

The table below summarises the geometric issues observed across the polymeric chains and their fit to the electron density. The red, orange, yellow and green segments on the lower bar indicate the fraction of residues that contain outliers for  $\geq 3$ , 2, 1 and 0 types of geometric quality criteria respectively. A grey segment represents the fraction of residues that are not modelled. The numeric value for each fraction is indicated below the corresponding segment, with a dot representing fractions  $\leq 5\%$ . The upper red bar (where present) indicates the fraction of residues that have poor fit to the electron density. The numeric value is given above the bar.

Mol	Chain	Length	Quality of chain
1	A	591	
1	B	591	
1	C	591	
1	D	591	
1	E	591	
1	F	591	

The following table lists non-polymeric compounds, carbohydrate monomers and non-standard residues in protein, DNA, RNA chains that are outliers for geometric or electron-density-fit criteria:

<b>Mol</b>	<b>Type</b>	<b>Chain</b>	<b>Res</b>	<b>Chirality</b>	<b>Geometry</b>	<b>Clashes</b>	<b>Electron density</b>
3	GOL	A	606	-	-	X	-
3	GOL	D	603	-	-	X	-
3	GOL	E	603	-	-	X	-
3	GOL	E	604	-	-	X	-
3	GOL	F	603	-	-	X	-
4	ACT	D	608	-	-	X	-

## 2 Entry composition [i](#)

There are 5 unique types of molecules in this entry. The entry contains 30404 atoms, of which 0 are hydrogens and 0 are deuteriums.

In the tables below, the ZeroOcc column contains the number of atoms modelled with zero occupancy, the AltConf column contains the number of residues with at least one atom in alternate conformation and the Trace column contains the number of residues modelled with at most 2 atoms.

- Molecule 1 is a protein called ADP-ribosylating toxin CARDS.

Mol	Chain	Residues	Atoms					ZeroOcc	AltConf	Trace
			Total	C	N	O	S			
1	A	582	4752	3037	810	889	16	0	1	0
1	B	580	4737	3027	808	887	15	0	1	0
1	C	577	4718	3015	805	882	16	0	0	0
1	D	577	4721	3018	805	883	15	0	2	0
1	E	582	4769	3049	814	890	16	0	4	0
1	F	573	4696	3000	803	878	15	0	1	0

There are 24 discrepancies between the modelled and reference sequences:

Chain	Residue	Modelled	Actual	Comment	Reference
A	-1	GLY	-	expression tag	UNP P75409
A	0	HIS	-	expression tag	UNP P75409
A	?	-	GLN	deletion	UNP P75409
A	?	-	LYS	deletion	UNP P75409
B	-1	GLY	-	expression tag	UNP P75409
B	0	HIS	-	expression tag	UNP P75409
B	?	-	GLN	deletion	UNP P75409
B	?	-	LYS	deletion	UNP P75409
C	-1	GLY	-	expression tag	UNP P75409
C	0	HIS	-	expression tag	UNP P75409
C	?	-	GLN	deletion	UNP P75409
C	?	-	LYS	deletion	UNP P75409
D	-1	GLY	-	expression tag	UNP P75409
D	0	HIS	-	expression tag	UNP P75409
D	?	-	GLN	deletion	UNP P75409
D	?	-	LYS	deletion	UNP P75409
E	-1	GLY	-	expression tag	UNP P75409

*Continued on next page...*

Continued from previous page...

Chain	Residue	Modelled	Actual	Comment	Reference
E	0	HIS	-	expression tag	UNP P75409
E	?	-	GLN	deletion	UNP P75409
E	?	-	LYS	deletion	UNP P75409
F	-1	GLY	-	expression tag	UNP P75409
F	0	HIS	-	expression tag	UNP P75409
F	?	-	GLN	deletion	UNP P75409
F	?	-	LYS	deletion	UNP P75409

- Molecule 2 is SULFATE ION (three-letter code: SO4) (formula: O<sub>4</sub>S).

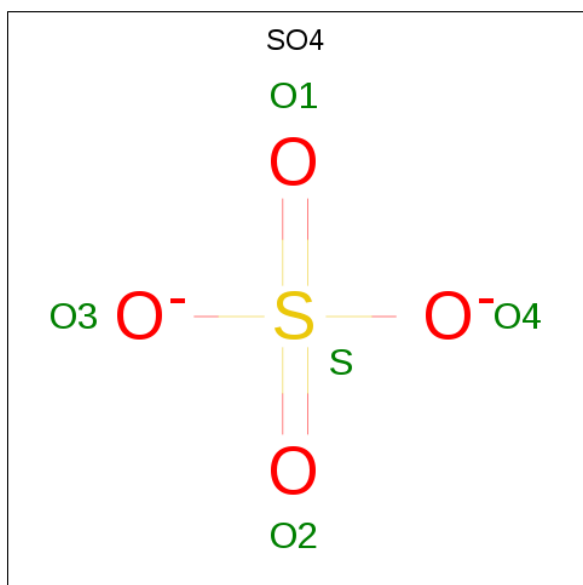

Mol	Chain	Residues	Atoms			ZeroOcc	AltConf
2	A	1	Total	O	S	0	0
			5	4	1		
2	A	1	Total	O	S	0	0
			5	4	1		
2	B	1	Total	O	S	0	0
			5	4	1		
2	D	1	Total	O	S	0	0
			5	4	1		
2	E	1	Total	O	S	0	0
			5	4	1		

- Molecule 3 is GLYCEROL (three-letter code: GOL) (formula: C<sub>3</sub>H<sub>8</sub>O<sub>3</sub>).



Mol	Chain	Residues	Atoms	ZeroOcc	AltConf
3	A	1	Total C O 6 3 3	0	0
3	A	1	Total C O 6 3 3	0	0
3	A	1	Total C O 6 3 3	0	0
3	A	1	Total C O 6 3 3	0	0
3	B	1	Total C O 6 3 3	0	0
3	B	1	Total C O 6 3 3	0	0
3	B	1	Total C O 6 3 3	0	0
3	C	1	Total C O 6 3 3	0	0
3	C	1	Total C O 6 3 3	0	0
3	C	1	Total C O 6 3 3	0	0
3	C	1	Total C O 6 3 3	0	0
3	C	1	Total C O 6 3 3	0	0
3	C	1	Total C O 6 3 3	0	0
3	C	1	Total C O 6 3 3	0	0

*Continued on next page...*

*Continued from previous page...*

Mol	Chain	Residues	Atoms			ZeroOcc	AltConf
3	D	1	Total	C	O	0	0
			6	3	3		
3	D	1	Total	C	O	0	0
			6	3	3		
3	D	1	Total	C	O	0	0
			6	3	3		
3	D	1	Total	C	O	0	0
			6	3	3		
3	D	1	Total	C	O	0	0
			6	3	3		
3	E	1	Total	C	O	0	0
			6	3	3		
3	E	1	Total	C	O	0	0
			6	3	3		
3	E	1	Total	C	O	0	0
			6	3	3		
3	E	1	Total	C	O	0	0
			6	3	3		
3	F	1	Total	C	O	0	0
			6	3	3		
3	F	1	Total	C	O	0	0
			6	3	3		
3	F	1	Total	C	O	0	0
			6	3	3		

- Molecule 4 is ACETATE ION (three-letter code: ACT) (formula: C<sub>2</sub>H<sub>3</sub>O<sub>2</sub>).

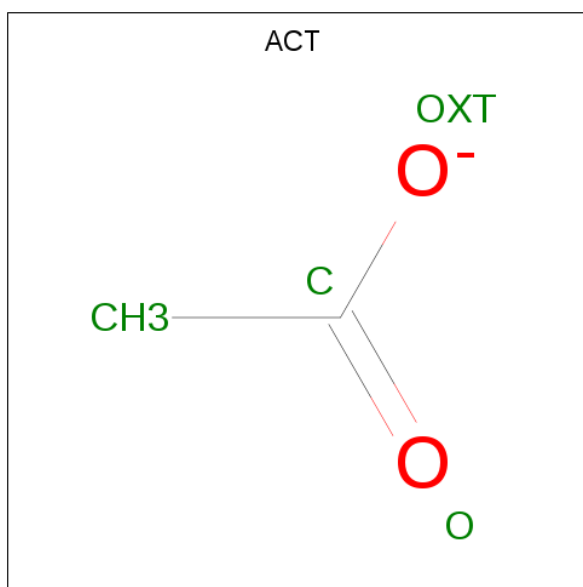

Mol	Chain	Residues	Atoms	ZeroOcc	AltConf
4	A	1	Total C O 4 2 2	0	0
4	A	1	Total C O 4 2 2	0	0
4	D	1	Total C O 4 2 2	0	0
4	E	1	Total C O 4 2 2	0	0

- Molecule 5 is water.

Mol	Chain	Residues	Atoms	ZeroOcc	AltConf
5	A	380	Total O 380 380	0	0
5	B	296	Total O 296 296	0	0
5	C	350	Total O 350 350	0	0
5	D	305	Total O 305 305	0	0
5	E	295	Total O 295 295	0	0
5	F	182	Total O 182 182	0	0



### 3 Residue-property plots [i](#)

These plots are drawn for all protein, RNA and DNA chains in the entry. The first graphic for a chain summarises the proportions of the various outlier classes displayed in the second graphic. The second graphic shows the sequence view annotated by issues in geometry and electron density. Residues are color-coded according to the number of geometric quality criteria for which they contain at least one outlier: green = 0, yellow = 1, orange = 2 and red = 3 or more. A red dot above a residue indicates a poor fit to the electron density ( $RSRZ > 2$ ). Stretches of 2 or more consecutive residues without any outlier are shown as a green connector. Residues present in the sample, but not in the model, are shown in grey.

- Molecule 1: ADP-ribosylating toxin CARDS

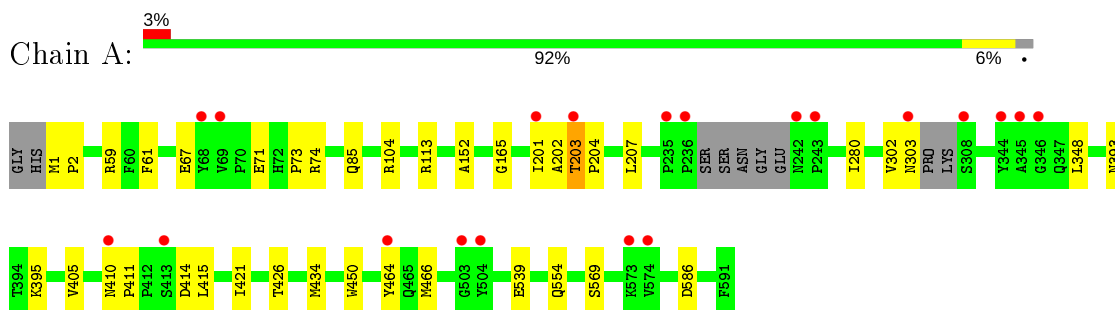

- Molecule 1: ADP-ribosylating toxin CARDS

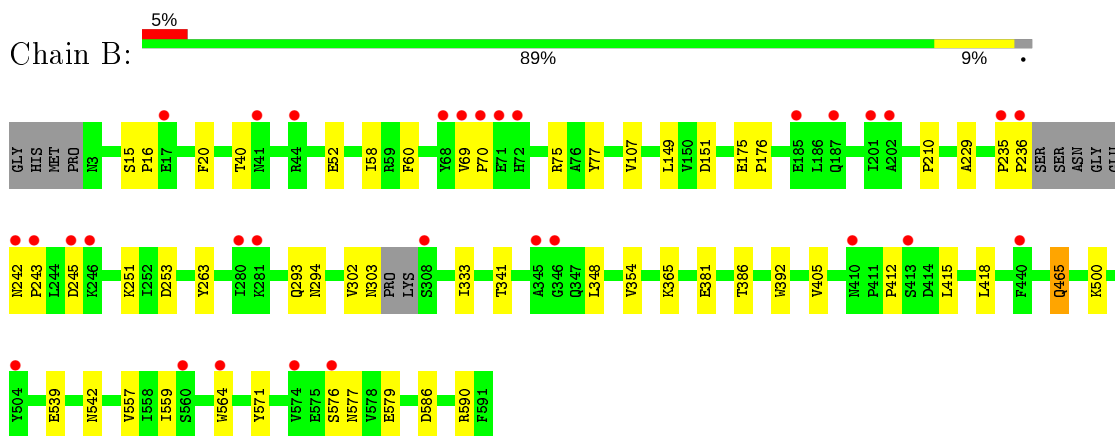

- Molecule 1: ADP-ribosylating toxin CARDS

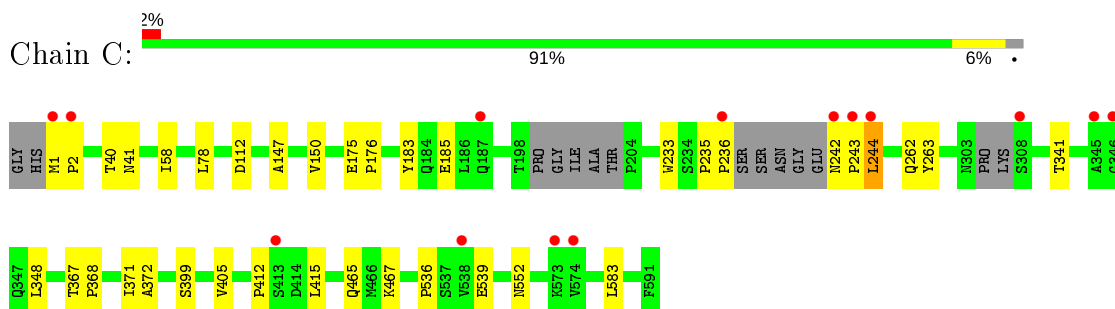

- Molecule 1: ADP-ribosylating toxin CARDS

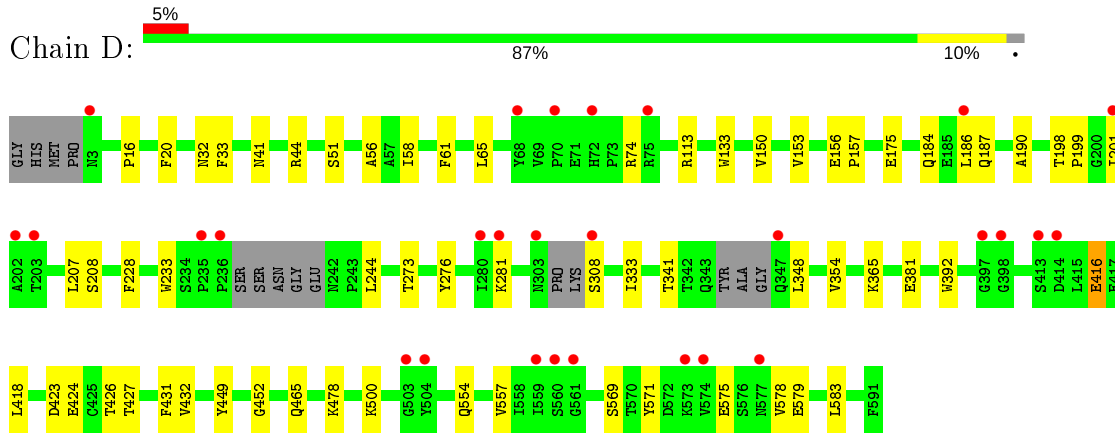

• Molecule 1: ADP-ribosylating toxin CARDS

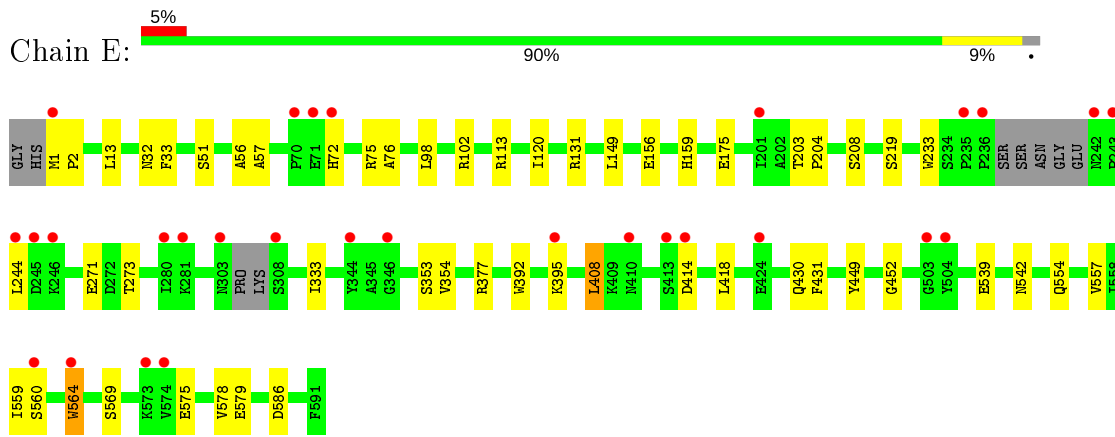

• Molecule 1: ADP-ribosylating toxin CARDS

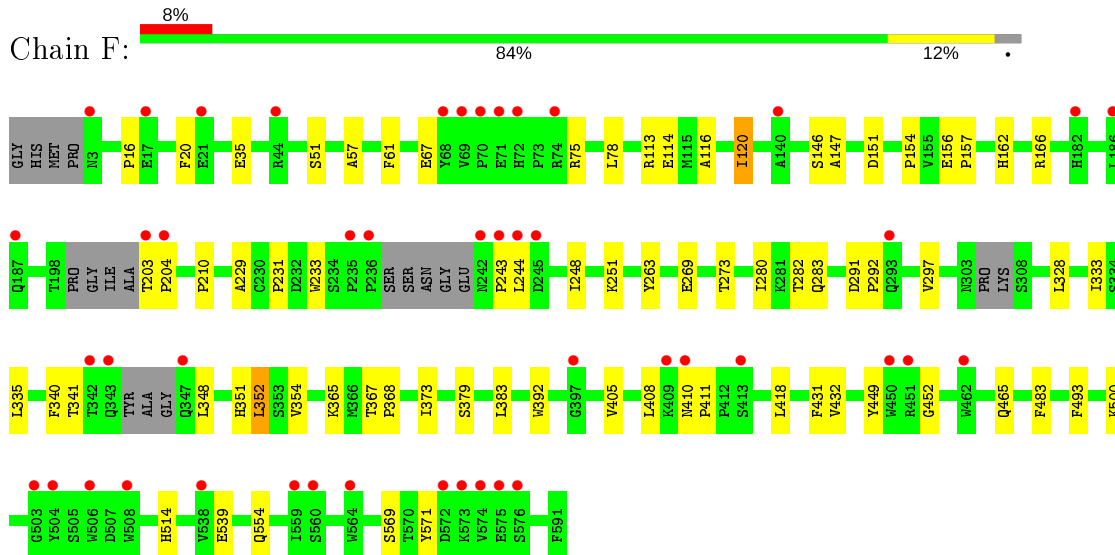

## 4 Data and refinement statistics i

Property	Value	Source
Space group	C 1 2 1	Depositor
Cell constants a, b, c, $\alpha$ , $\beta$ , $\gamma$	191.70Å 107.41Å 222.26Å 90.00° 90.64° 90.00°	Depositor
Resolution (Å)	38.87 – 1.90 38.87 – 1.90	Depositor EDS
% Data completeness (in resolution range)	99.4 (38.87-1.90) 99.4 (38.87-1.90)	Depositor EDS
$R_{merge}$	(Not available)	Depositor
$R_{sym}$	0.07	Depositor
$\langle I/\sigma(I) \rangle$ <sup>1</sup>	2.49 (at 1.91Å)	Xtriage
Refinement program	PHENIX (PHENIX.REFINE: 1.7.3_928)	Depositor
R, $R_{free}$	0.186 , 0.215 0.182 , 0.210	Depositor DCC
$R_{free}$ test set	17675 reflections (5.05%)	wwPDB-VP
Wilson B-factor (Å <sup>2</sup> )	22.0	Xtriage
Anisotropy	0.423	Xtriage
Bulk solvent $k_{sol}$ (e/Å <sup>3</sup> ), $B_{sol}$ (Å <sup>2</sup> )	0.36 , 48.6	EDS
L-test for twinning <sup>2</sup>	$\langle  L  \rangle = 0.50$ , $\langle L^2 \rangle = 0.33$	Xtriage
Estimated twinning fraction	0.005 for -1/2*h-3/2*k,-1/2*h+1/2*k,-l 0.005 for -1/2*h+3/2*k,1/2*h+1/2*k,-l 0.029 for 1/2*h-3/2*k,-1/2*h-1/2*k,-l 0.019 for 1/2*h+3/2*k,1/2*h-1/2*k,-l 0.010 for -h,-k,l	Xtriage
$F_o, F_c$ correlation	0.96	EDS
Total number of atoms	30404	wwPDB-VP
Average B, all atoms (Å <sup>2</sup> )	27.0	wwPDB-VP

Xtriage's analysis on translational NCS is as follows: *The largest off-origin peak in the Patterson function is 2.58% of the height of the origin peak. No significant pseudotranslation is detected.*

<sup>1</sup> Intensities estimated from amplitudes.

<sup>2</sup> Theoretical values of  $\langle |L| \rangle$ ,  $\langle L^2 \rangle$  for acentric reflections are 0.5, 0.333 respectively for untwinned datasets, and 0.375, 0.2 for perfectly twinned datasets.

## 5 Model quality [i](#)

### 5.1 Standard geometry [i](#)

Bond lengths and bond angles in the following residue types are not validated in this section: GOL, SO4, ACT

The Z score for a bond length (or angle) is the number of standard deviations the observed value is removed from the expected value. A bond length (or angle) with  $|Z| > 5$  is considered an outlier worth inspection. RMSZ is the root-mean-square of all Z scores of the bond lengths (or angles).

Mol	Chain	Bond lengths		Bond angles	
		RMSZ	# Z  >5	RMSZ	# Z  >5
1	A	0.50	0/4894	0.58	0/6661
1	B	0.48	0/4878	0.54	0/6639
1	C	0.48	0/4855	0.56	0/6604
1	D	0.49	0/4863	0.54	0/6617
1	E	0.45	0/4922	0.53	0/6699
1	F	0.43	0/4834	0.51	0/6575
All	All	0.47	0/29246	0.55	0/39795

There are no bond length outliers.

There are no bond angle outliers.

There are no chirality outliers.

There are no planarity outliers.

### 5.2 Too-close contacts [i](#)

In the following table, the Non-H and H(model) columns list the number of non-hydrogen atoms and hydrogen atoms in the chain respectively. The H(added) column lists the number of hydrogen atoms added and optimized by MolProbity. The Clashes column lists the number of clashes within the asymmetric unit, whereas Symm-Clashes lists symmetry related clashes.

Mol	Chain	Non-H	H(model)	H(added)	Clashes	Symm-Clashes
1	A	4752	0	4532	29	0
1	B	4737	0	4513	34	0
1	C	4718	0	4494	28	0
1	D	4721	0	4506	56	0
1	E	4769	0	4551	40	0
1	F	4696	0	4470	45	0
2	A	10	0	0	0	0

*Continued on next page...*

Continued from previous page...

Mol	Chain	Non-H	H(model)	H(added)	Clashes	Symm-Clashes
2	B	5	0	0	0	0
2	D	5	0	0	0	0
2	E	5	0	0	0	0
3	A	24	0	32	5	0
3	B	18	0	24	2	0
3	C	42	0	56	7	0
3	D	36	0	48	15	0
3	E	24	0	32	13	0
3	F	18	0	24	5	0
4	A	8	0	6	0	0
4	D	4	0	3	3	0
4	E	4	0	3	1	0
5	A	380	0	0	3	0
5	B	296	0	0	3	0
5	C	350	0	0	3	0
5	D	305	0	0	3	0
5	E	295	0	0	1	0
5	F	182	0	0	1	0
All	All	30404	0	27294	229	0

The all-atom clashscore is defined as the number of clashes found per 1000 atoms (including hydrogen atoms). The all-atom clashscore for this structure is 4.

The worst 5 of 229 close contacts within the same asymmetric unit are listed below, sorted by their clash magnitude.

Atom-1	Atom-2	Interatomic distance (Å)	Clash overlap (Å)
1:C:112:ASP:HB2	3:C:607:GOL:H32	1.41	1.01
1:D:32:ASN:HA	3:D:603:GOL:H11	1.45	0.99
1:D:58[A]:ILE:HD11	1:D:150:VAL:HG11	1.52	0.91
1:D:208:SER:H	3:D:603:GOL:H32	1.46	0.81
1:E:560:SER:HA	1:E:564:TRP:HB2	1.62	0.81

There are no symmetry-related clashes.

## 5.3 Torsion angles [i](#)

### 5.3.1 Protein backbone [i](#)

In the following table, the Percentiles column shows the percent Ramachandran outliers of the chain as a percentile score with respect to all X-ray entries followed by that with respect to entries of similar resolution.

The Analysed column shows the number of residues for which the backbone conformation was analysed, and the total number of residues.

Mol	Chain	Analysed	Favoured	Allowed	Outliers	Percentiles	
1	A	577/591 (98%)	558 (97%)	18 (3%)	1 (0%)	47	38
1	B	575/591 (97%)	556 (97%)	19 (3%)	0	100	100
1	C	569/591 (96%)	555 (98%)	14 (2%)	0	100	100
1	D	571/591 (97%)	554 (97%)	16 (3%)	1 (0%)	47	38
1	E	580/591 (98%)	565 (97%)	14 (2%)	1 (0%)	47	38
1	F	564/591 (95%)	540 (96%)	23 (4%)	1 (0%)	47	38
All	All	3436/3546 (97%)	3328 (97%)	104 (3%)	4 (0%)	51	43

All (4) Ramachandran outliers are listed below:

Mol	Chain	Res	Type
1	A	203	THR
1	E	219	SER
1	F	432	VAL
1	D	432	VAL

### 5.3.2 Protein sidechains [i](#)

In the following table, the Percentiles column shows the percent sidechain outliers of the chain as a percentile score with respect to all X-ray entries followed by that with respect to entries of similar resolution.

The Analysed column shows the number of residues for which the sidechain conformation was analysed, and the total number of residues.

Mol	Chain	Analysed	Rotameric	Outliers	Percentiles	
1	A	518/524 (99%)	515 (99%)	3 (1%)	86	87
1	B	516/524 (98%)	511 (99%)	5 (1%)	76	76
1	C	514/524 (98%)	509 (99%)	5 (1%)	76	76
1	D	516/524 (98%)	510 (99%)	6 (1%)	71	70
1	E	521/524 (99%)	516 (99%)	5 (1%)	76	76
1	F	513/524 (98%)	506 (99%)	7 (1%)	67	65
All	All	3098/3144 (98%)	3067 (99%)	31 (1%)	76	76

5 of 31 residues with a non-rotameric sidechain are listed below:

Mol	Chain	Res	Type
1	D	207	LEU
1	D	465	GLN
1	F	352	LEU
1	D	308	SER
1	D	478	LYS

Some sidechains can be flipped to improve hydrogen bonding and reduce clashes. There are no such sidechains identified.

### 5.3.3 RNA [i](#)

There are no RNA molecules in this entry.

### 5.4 Non-standard residues in protein, DNA, RNA chains [i](#)

There are no non-standard protein/DNA/RNA residues in this entry.

### 5.5 Carbohydrates [i](#)

There are no carbohydrates in this entry.

### 5.6 Ligand geometry [i](#)

36 ligands are modelled in this entry.

In the following table, the Counts columns list the number of bonds (or angles) for which Mogul statistics could be retrieved, the number of bonds (or angles) that are observed in the model and the number of bonds (or angles) that are defined in the Chemical Component Dictionary. The Link column lists molecule types, if any, to which the group is linked. The Z score for a bond length (or angle) is the number of standard deviations the observed value is removed from the expected value. A bond length (or angle) with  $|Z| > 2$  is considered an outlier worth inspection. RMSZ is the root-mean-square of all Z scores of the bond lengths (or angles).

Mol	Type	Chain	Res	Link	Bond lengths			Bond angles		
					Counts	RMSZ	$\# Z  > 2$	Counts	RMSZ	$\# Z  > 2$
3	GOL	A	603	-	5,5,5	0.43	0	5,5,5	0.31	0
3	GOL	D	603	-	5,5,5	0.36	0	5,5,5	0.64	0
3	GOL	F	603	-	5,5,5	0.32	0	5,5,5	0.27	0
3	GOL	E	603	-	5,5,5	0.36	0	5,5,5	0.28	0
3	GOL	D	606	-	5,5,5	0.38	0	5,5,5	0.24	0
3	GOL	A	605	-	5,5,5	0.34	0	5,5,5	0.31	0
3	GOL	C	602	-	5,5,5	0.35	0	5,5,5	0.46	0

Mol	Type	Chain	Res	Link	Bond lengths			Bond angles		
					Counts	RMSZ	# Z  > 2	Counts	RMSZ	# Z  > 2
3	GOL	E	602	-	5,5,5	0.42	0	5,5,5	0.28	0
3	GOL	D	604	-	5,5,5	0.34	0	5,5,5	0.27	0
2	SO4	B	601	-	4,4,4	0.18	0	6,6,6	0.13	0
3	GOL	C	607	-	5,5,5	0.35	0	5,5,5	0.91	0
3	GOL	E	604	-	5,5,5	0.55	0	5,5,5	0.82	0
4	ACT	E	606	-	1,3,3	1.07	0	0,3,3	0.00	-
3	GOL	F	602	-	5,5,5	0.41	0	5,5,5	0.31	0
3	GOL	A	606	-	5,5,5	0.33	0	5,5,5	0.74	0
4	ACT	A	607	-	1,3,3	1.25	0	0,3,3	0.00	-
3	GOL	B	604	-	5,5,5	0.40	0	5,5,5	0.40	0
2	SO4	D	601	-	4,4,4	0.82	0	6,6,6	1.38	1 (16%)
2	SO4	E	601	-	4,4,4	0.16	0	6,6,6	0.27	0
3	GOL	C	604	-	5,5,5	0.36	0	5,5,5	0.28	0
3	GOL	B	602	-	5,5,5	0.47	0	5,5,5	0.18	0
3	GOL	A	604	-	5,5,5	0.35	0	5,5,5	0.31	0
3	GOL	D	602	-	5,5,5	0.35	0	5,5,5	0.56	0
4	ACT	D	608	-	1,3,3	1.11	0	0,3,3	0.00	-
3	GOL	C	601	-	5,5,5	0.39	0	5,5,5	0.40	0
3	GOL	F	601	-	5,5,5	0.39	0	5,5,5	0.29	0
3	GOL	C	606	-	5,5,5	0.33	0	5,5,5	0.49	0
3	GOL	D	607	-	5,5,5	0.34	0	5,5,5	0.33	0
2	SO4	A	601	-	4,4,4	0.20	0	6,6,6	0.21	0
3	GOL	B	603	-	5,5,5	0.42	0	5,5,5	0.29	0
3	GOL	C	603	-	5,5,5	0.41	0	5,5,5	0.39	0
2	SO4	A	602	-	4,4,4	0.13	0	6,6,6	0.16	0
3	GOL	D	605	-	5,5,5	0.34	0	5,5,5	0.23	0
3	GOL	E	605	-	5,5,5	0.32	0	5,5,5	0.37	0
3	GOL	C	605	-	5,5,5	0.33	0	5,5,5	0.33	0
4	ACT	A	608	-	1,3,3	1.22	0	0,3,3	0.00	-

In the following table, the Chirals column lists the number of chiral outliers, the number of chiral centers analysed, the number of these observed in the model and the number defined in the Chemical Component Dictionary. Similar counts are reported in the Torsion and Rings columns. '-' means no outliers of that kind were identified.

Mol	Type	Chain	Res	Link	Chirals	Torsions	Rings
3	GOL	A	603	-	-	0/4/4/4	-
3	GOL	D	603	-	-	0/4/4/4	-
3	GOL	F	603	-	-	2/4/4/4	-
3	GOL	E	603	-	-	2/4/4/4	-
3	GOL	D	606	-	-	4/4/4/4	-
3	GOL	A	605	-	-	2/4/4/4	-

Continued on next page...



Continued from previous page...

Mol	Type	Chain	Res	Link	Chirals	Torsions	Rings
3	GOL	C	602	-	-	2/4/4/4	-
3	GOL	E	602	-	-	0/4/4/4	-
3	GOL	D	604	-	-	2/4/4/4	-
3	GOL	C	607	-	-	4/4/4/4	-
3	GOL	E	604	-	-	4/4/4/4	-
3	GOL	F	602	-	-	2/4/4/4	-
3	GOL	A	606	-	-	3/4/4/4	-
3	GOL	B	604	-	-	2/4/4/4	-
3	GOL	C	604	-	-	0/4/4/4	-
3	GOL	B	602	-	-	2/4/4/4	-
3	GOL	A	604	-	-	4/4/4/4	-
3	GOL	D	602	-	-	2/4/4/4	-
3	GOL	C	601	-	-	0/4/4/4	-
3	GOL	F	601	-	-	2/4/4/4	-
3	GOL	C	606	-	-	2/4/4/4	-
3	GOL	D	607	-	-	0/4/4/4	-
3	GOL	B	603	-	-	0/4/4/4	-
3	GOL	C	603	-	-	2/4/4/4	-
3	GOL	D	605	-	-	4/4/4/4	-
3	GOL	E	605	-	-	2/4/4/4	-
3	GOL	C	605	-	-	1/4/4/4	-

There are no bond length outliers.

All (1) bond angle outliers are listed below:

Mol	Chain	Res	Type	Atoms	Z	Observed(°)	Ideal(°)
2	D	601	SO4	O4-S-O2	3.09	125.42	109.31

There are no chirality outliers.

5 of 50 torsion outliers are listed below:

Mol	Chain	Res	Type	Atoms
3	E	603	GOL	O1-C1-C2-C3
3	D	606	GOL	C1-C2-C3-O3
3	A	605	GOL	O1-C1-C2-C3
3	C	602	GOL	C1-C2-C3-O3
3	D	604	GOL	C1-C2-C3-O3

There are no ring outliers.

19 monomers are involved in 51 short contacts:

Mol	Chain	Res	Type	Clashes	Symm-Clashes
3	D	603	GOL	9	0
3	F	603	GOL	4	0
3	E	603	GOL	4	0
3	D	606	GOL	2	0
3	D	604	GOL	2	0
3	C	607	GOL	2	0
3	E	604	GOL	8	0
4	E	606	ACT	1	0
3	F	602	GOL	1	0
3	A	606	GOL	4	0
3	B	604	GOL	1	0
3	B	602	GOL	1	0
3	A	604	GOL	1	0
4	D	608	ACT	3	0
3	C	601	GOL	1	0
3	C	606	GOL	1	0
3	C	603	GOL	3	0
3	D	605	GOL	2	0
3	E	605	GOL	1	0

## 5.7 Other polymers [i](#)

There are no such residues in this entry.

## 5.8 Polymer linkage issues [i](#)

There are no chain breaks in this entry.

## 6 Fit of model and data [i](#)

### 6.1 Protein, DNA and RNA chains [i](#)

In the following table, the column labelled ‘#RSRZ> 2’ contains the number (and percentage) of RSRZ outliers, followed by percent RSRZ outliers for the chain as percentile scores relative to all X-ray entries and entries of similar resolution. The OWAB column contains the minimum, median, 95<sup>th</sup> percentile and maximum values of the occupancy-weighted average B-factor per residue. The column labelled ‘Q< 0.9’ lists the number of (and percentage) of residues with an average occupancy less than 0.9.

Mol	Chain	Analysed	<RSRZ>	#RSRZ>2	OWAB(Å <sup>2</sup> )	Q<0.9
1	A	582/591 (98%)	0.04	20 (3%) 45 48	10, 19, 43, 65	0
1	B	580/591 (98%)	0.16	31 (5%) 26 29	12, 24, 51, 75	0
1	C	577/591 (97%)	-0.09	14 (2%) 59 62	12, 21, 44, 65	0
1	D	577/591 (97%)	0.10	28 (4%) 29 33	13, 23, 48, 74	0
1	E	582/591 (98%)	0.08	29 (4%) 28 32	14, 26, 52, 78	0
1	F	573/591 (96%)	0.34	46 (8%) 12 13	18, 32, 56, 84	0
All	All	3471/3546 (97%)	0.10	168 (4%) 30 33	10, 24, 50, 84	0

The worst 5 of 168 RSRZ outliers are listed below:

Mol	Chain	Res	Type	RSRZ
1	B	70	PRO	7.6
1	A	203	THR	6.4
1	F	347	GLN	6.0
1	A	345	ALA	6.0
1	F	72	HIS	5.8

### 6.2 Non-standard residues in protein, DNA, RNA chains [i](#)

There are no non-standard protein/DNA/RNA residues in this entry.

### 6.3 Carbohydrates [i](#)

There are no carbohydrates in this entry.

## 6.4 Ligands [i](#)

In the following table, the Atoms column lists the number of modelled atoms in the group and the number defined in the chemical component dictionary. The B-factors column lists the minimum, median, 95<sup>th</sup> percentile and maximum values of B factors of atoms in the group. The column labelled 'Q< 0.9' lists the number of atoms with occupancy less than 0.9.

Mol	Type	Chain	Res	Atoms	RSCC	RSR	B-factors(Å <sup>2</sup> )	Q<0.9
3	GOL	E	603	6/6	0.72	0.15	36,39,43,47	0
3	GOL	F	603	6/6	0.73	0.21	29,33,35,41	6
2	SO4	D	601	5/5	0.80	0.21	32,34,40,43	5
3	GOL	C	602	6/6	0.82	0.39	19,23,26,28	6
3	GOL	D	607	6/6	0.83	0.24	30,35,37,43	6
3	GOL	C	603	6/6	0.83	0.20	18,26,27,30	6
3	GOL	C	607	6/6	0.85	0.21	22,26,39,40	6
3	GOL	D	606	6/6	0.87	0.16	28,36,37,38	6
3	GOL	D	603	6/6	0.87	0.19	20,22,30,34	6
3	GOL	E	605	6/6	0.87	0.21	25,29,30,39	6
3	GOL	C	606	6/6	0.88	0.19	27,29,32,32	6
3	GOL	A	606	6/6	0.89	0.22	9,18,19,19	6
3	GOL	B	603	6/6	0.89	0.37	21,22,24,24	6
3	GOL	D	604	6/6	0.89	0.11	30,34,41,43	0
3	GOL	E	604	6/6	0.89	0.18	19,27,32,32	6
3	GOL	A	605	6/6	0.90	0.14	16,28,31,32	6
3	GOL	B	604	6/6	0.90	0.17	26,31,37,39	6
3	GOL	C	604	6/6	0.91	0.21	31,38,44,50	0
3	GOL	F	601	6/6	0.92	0.39	29,30,31,32	6
2	SO4	B	601	5/5	0.92	0.12	32,35,37,41	5
3	GOL	C	605	6/6	0.92	0.16	23,29,32,37	6
3	GOL	A	603	6/6	0.93	0.23	16,20,26,30	6
3	GOL	D	605	6/6	0.93	0.11	23,30,34,35	6
4	ACT	E	606	4/4	0.94	0.15	27,33,34,34	4
2	SO4	A	602	5/5	0.94	0.13	30,30,35,37	5
3	GOL	A	604	6/6	0.94	0.11	29,35,36,37	6
3	GOL	D	602	6/6	0.94	0.22	21,24,30,31	6
3	GOL	C	601	6/6	0.94	0.30	17,21,21,23	6
3	GOL	E	602	6/6	0.95	0.20	20,23,28,29	6
3	GOL	F	602	6/6	0.95	0.27	25,29,32,32	6
3	GOL	B	602	6/6	0.96	0.26	17,23,23,26	6
4	ACT	D	608	4/4	0.96	0.09	23,28,31,33	4
4	ACT	A	608	4/4	0.96	0.19	15,19,20,22	4
4	ACT	A	607	4/4	0.98	0.07	20,25,26,26	0
2	SO4	A	601	5/5	0.99	0.07	15,15,19,20	0
2	SO4	E	601	5/5	0.99	0.07	17,18,22,23	0

## 6.5 Other polymers

There are no such residues in this entry.