



Full wwPDB X-ray Structure Validation Report ⓘ

Sep 12, 2023 – 03:06 PM EDT

PDB ID : 4NKY
Title : Human steroidogenic cytochrome P450 17A1 mutant A105L with substrate 17alpha-hydroxyprogesterone
Authors : Scott, E.E.; Petrunak, E.M.
Deposited on : 2013-11-13
Resolution : 2.55 Å(reported)

This is a Full wwPDB X-ray Structure Validation Report for a publicly released PDB entry.

We welcome your comments at validation@mail.wwpdb.org

A user guide is available at

<https://www.wwpdb.org/validation/2017/XrayValidationReportHelp>

with specific help available everywhere you see the ⓘ symbol.

The types of validation reports are described at

<http://www.wwpdb.org/validation/2017/FAQs#types>.

The following versions of software and data (see [references ⓘ](#)) were used in the production of this report:

MolProbity : 4.02b-467
Mogul : 1.8.5 (274361), CSD as541be (2020)
Xtriage (Phenix) : 1.13
EDS : 2.35.1
buster-report : 1.1.7 (2018)
Percentile statistics : 20191225.v01 (using entries in the PDB archive December 25th 2019)
Refmac : 5.8.0158
CCP4 : 7.0.044 (Gargrove)
Ideal geometry (proteins) : Engh & Huber (2001)
Ideal geometry (DNA, RNA) : Parkinson et al. (1996)
Validation Pipeline (wwPDB-VP) : 2.35.1

1 Overall quality at a glance

The following experimental techniques were used to determine the structure:

X-RAY DIFFRACTION

The reported resolution of this entry is 2.55 Å.

Percentile scores (ranging between 0-100) for global validation metrics of the entry are shown in the following graphic. The table shows the number of entries on which the scores are based.

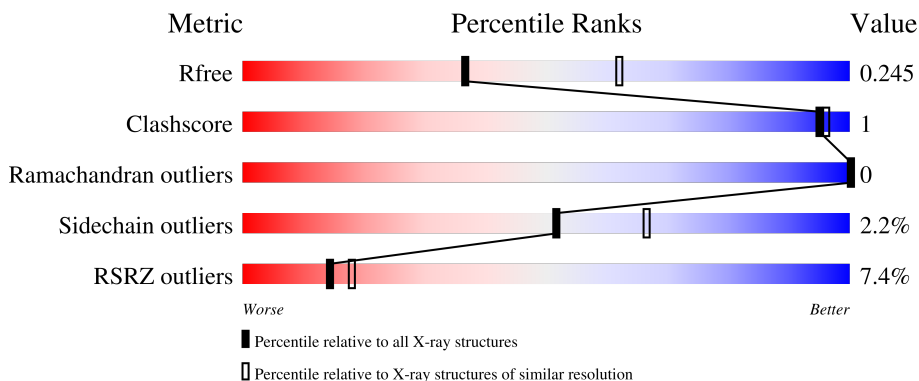

Metric	Whole archive (#Entries)	Similar resolution (#Entries, resolution range(Å))
R_{free}	130704	1284 (2.56-2.52)
Clashscore	141614	1332 (2.56-2.52)
Ramachandran outliers	138981	1315 (2.56-2.52)
Sidechain outliers	138945	1315 (2.56-2.52)
RSRZ outliers	127900	1272 (2.56-2.52)

The table below summarises the geometric issues observed across the polymeric chains and their fit to the electron density. The red, orange, yellow and green segments of the lower bar indicate the fraction of residues that contain outliers for ≥ 3 , 2, 1 and 0 types of geometric quality criteria respectively. A grey segment represents the fraction of residues that are not modelled. The numeric value for each fraction is indicated below the corresponding segment, with a dot representing fractions $\leq 5\%$. The upper red bar (where present) indicates the fraction of residues that have poor fit to the electron density. The numeric value is given above the bar.

Mol	Chain	Length	Quality of chain
1	A	494	 9% 89% 5% 6%
1	B	494	 6% 88% 5% 6%
1	C	494	 6% 90% 5% 6%
1	D	494	 6% 91% 5% 6%

2 Entry composition [i](#)

There are 4 unique types of molecules in this entry. The entry contains 30605 atoms, of which 15344 are hydrogens and 0 are deuteriums.

In the tables below, the ZeroOcc column contains the number of atoms modelled with zero occupancy, the AltConf column contains the number of residues with at least one atom in alternate conformation and the Trace column contains the number of residues modelled with at most 2 atoms.

- Molecule 1 is a protein called Steroid 17-alpha-hydroxylase/17,20 lyase.

Mol	Chain	Residues	Atoms						ZeroOcc	AltConf	Trace
			Total	C	H	N	O	S			
1	A	462	7473	2373	3782	638	665	15	0	0	0
1	B	464	7496	2379	3793	640	669	15	0	0	0
1	C	467	7466	2393	3739	645	674	15	0	0	0
1	D	465	7501	2383	3790	641	672	15	0	0	0

There are 40 discrepancies between the modelled and reference sequences:

Chain	Residue	Modelled	Actual	Comment	Reference
A	19	MET	-	expression tag	UNP P05093
A	20	ALA	-	expression tag	UNP P05093
A	21	LYS	-	expression tag	UNP P05093
A	22	LYS	-	expression tag	UNP P05093
A	23	THR	-	expression tag	UNP P05093
A	105	LEU	ALA	engineered mutation	UNP P05093
A	509	HIS	-	expression tag	UNP P05093
A	510	HIS	-	expression tag	UNP P05093
A	511	HIS	-	expression tag	UNP P05093
A	512	HIS	-	expression tag	UNP P05093
B	19	MET	-	expression tag	UNP P05093
B	20	ALA	-	expression tag	UNP P05093
B	21	LYS	-	expression tag	UNP P05093
B	22	LYS	-	expression tag	UNP P05093
B	23	THR	-	expression tag	UNP P05093
B	105	LEU	ALA	engineered mutation	UNP P05093
B	509	HIS	-	expression tag	UNP P05093
B	510	HIS	-	expression tag	UNP P05093
B	511	HIS	-	expression tag	UNP P05093
B	512	HIS	-	expression tag	UNP P05093
C	19	MET	-	expression tag	UNP P05093

Continued on next page...

Continued from previous page...

Chain	Residue	Modelled	Actual	Comment	Reference
C	20	ALA	-	expression tag	UNP P05093
C	21	LYS	-	expression tag	UNP P05093
C	22	LYS	-	expression tag	UNP P05093
C	23	THR	-	expression tag	UNP P05093
C	105	LEU	ALA	engineered mutation	UNP P05093
C	509	HIS	-	expression tag	UNP P05093
C	510	HIS	-	expression tag	UNP P05093
C	511	HIS	-	expression tag	UNP P05093
C	512	HIS	-	expression tag	UNP P05093
D	19	MET	-	expression tag	UNP P05093
D	20	ALA	-	expression tag	UNP P05093
D	21	LYS	-	expression tag	UNP P05093
D	22	LYS	-	expression tag	UNP P05093
D	23	THR	-	expression tag	UNP P05093
D	105	LEU	ALA	engineered mutation	UNP P05093
D	509	HIS	-	expression tag	UNP P05093
D	510	HIS	-	expression tag	UNP P05093
D	511	HIS	-	expression tag	UNP P05093
D	512	HIS	-	expression tag	UNP P05093

- Molecule 2 is PROTOPORPHYRIN IX CONTAINING FE (three-letter code: HEM) (formula: $C_{34}H_{32}FeN_4O_4$).

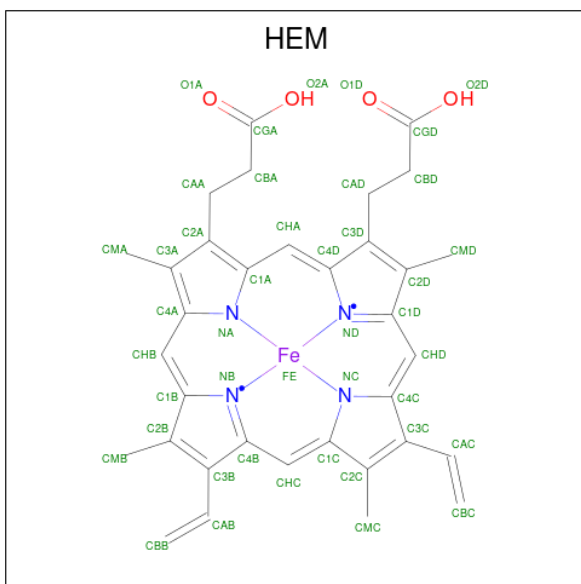

Mol	Chain	Residues	Atoms					ZeroOcc	AltConf	
			Total	C	Fe	H	N			O
2	A	1	73	34	1	30	4	4	0	0

Continued on next page...

Continued from previous page...

Mol	Chain	Residues	Atoms					ZeroOcc	AltConf	
2	B	1	Total	C	Fe	H	N	O	0	0
			73	34	1	30	4	4		
2	C	1	Total	C	Fe	H	N	O	0	0
			73	34	1	30	4	4		
2	D	1	Total	C	Fe	H	N	O	0	0
			73	34	1	30	4	4		

- Molecule 3 is (9beta)-17-hydroxypregn-4-ene-3,20-dione (three-letter code: 3QZ) (formula: $C_{21}H_{30}O_3$).

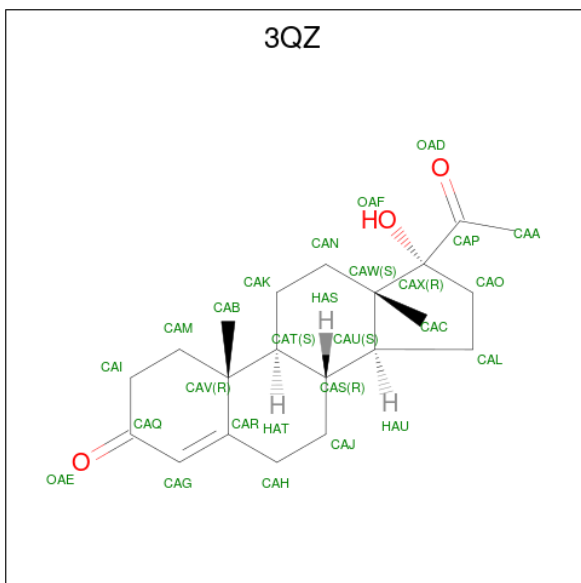

Mol	Chain	Residues	Atoms			ZeroOcc	AltConf	
3	A	1	Total	C	H	O	0	0
			54	21	30	3		
3	B	1	Total	C	H	O	0	0
			54	21	30	3		
3	C	1	Total	C	H	O	0	0
			54	21	30	3		
3	D	1	Total	C	H	O	0	0
			54	21	30	3		

- Molecule 4 is water.

Mol	Chain	Residues	Atoms		ZeroOcc	AltConf
4	A	40	Total	O	0	0
			40	40		
4	B	36	Total	O	0	0
			36	36		

Continued on next page...

Continued from previous page...

Mol	Chain	Residues	Atoms		ZeroOcc	AltConf
4	C	53	Total 53	O 53	0	0
4	D	32	Total 32	O 32	0	0

3 Residue-property plots

These plots are drawn for all protein, RNA, DNA and oligosaccharide chains in the entry. The first graphic for a chain summarises the proportions of the various outlier classes displayed in the second graphic. The second graphic shows the sequence view annotated by issues in geometry and electron density. Residues are color-coded according to the number of geometric quality criteria for which they contain at least one outlier: green = 0, yellow = 1, orange = 2 and red = 3 or more. A red dot above a residue indicates a poor fit to the electron density ($RSRZ > 2$). Stretches of 2 or more consecutive residues without any outlier are shown as a green connector. Residues present in the sample, but not in the model, are shown in grey.

- Molecule 1: Steroid 17-alpha-hydroxylase/17,20 lyase

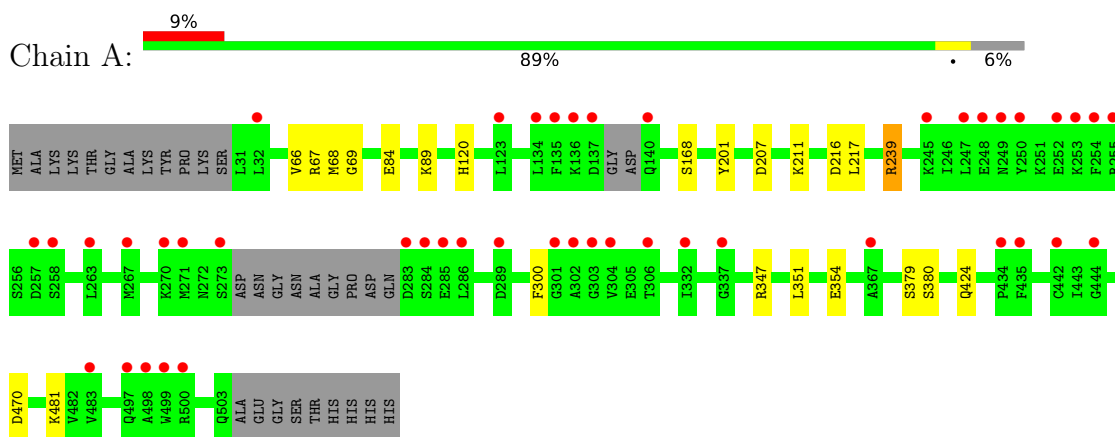

- Molecule 1: Steroid 17-alpha-hydroxylase/17,20 lyase

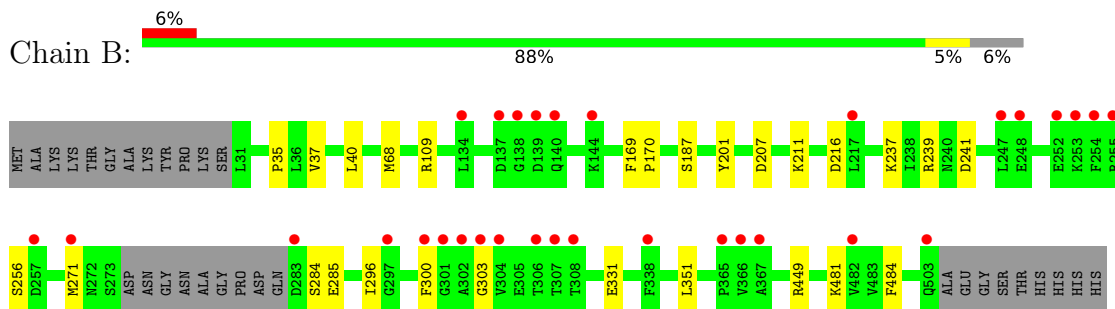

- Molecule 1: Steroid 17-alpha-hydroxylase/17,20 lyase

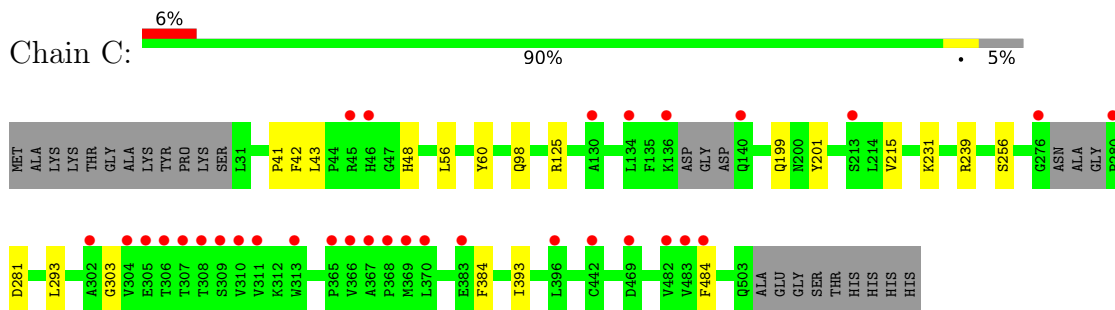

- Molecule 1: Steroid 17-alpha-hydroxylase/17,20 lyase

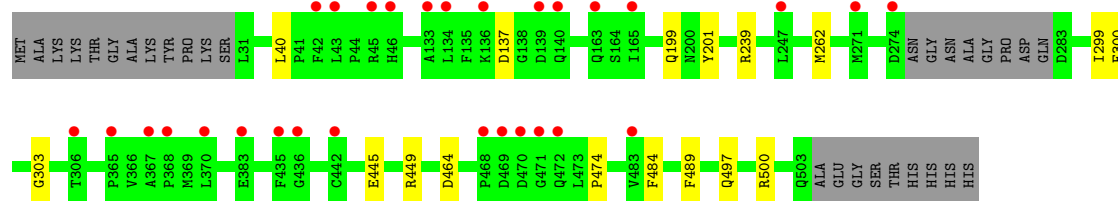
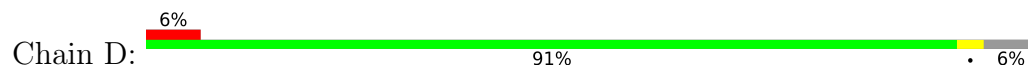

4 Data and refinement statistics

Property	Value	Source
Space group	P 21 21 21	Depositor
Cell constants a, b, c, α , β , γ	91.28Å 151.78Å 168.04Å 90.00° 90.00° 90.00°	Depositor
Resolution (Å)	39.15 – 2.55 39.15 – 2.55	Depositor EDS
% Data completeness (in resolution range)	98.8 (39.15-2.55) 98.8 (39.15-2.55)	Depositor EDS
R_{merge}	(Not available)	Depositor
R_{sym}	(Not available)	Depositor
$\langle I/\sigma(I) \rangle$ ¹	1.50 (at 2.54Å)	Xtrriage
Refinement program	PHENIX (phenix.refine: 1.8.2_1309)	Depositor
R, R_{free}	0.178 , 0.244 0.181 , 0.245	Depositor DCC
R_{free} test set	3806 reflections (5.02%)	wwPDB-VP
Wilson B-factor (Å ²)	52.4	Xtrriage
Anisotropy	0.466	Xtrriage
Bulk solvent k_{sol} (e/Å ³), B_{sol} (Å ²)	0.41 , 47.8	EDS
L-test for twinning ²	$\langle L \rangle = 0.49$, $\langle L^2 \rangle = 0.32$	Xtrriage
Estimated twinning fraction	No twinning to report.	Xtrriage
F_o, F_c correlation	0.95	EDS
Total number of atoms	30605	wwPDB-VP
Average B, all atoms (Å ²)	56.0	wwPDB-VP

Xtrriage's analysis on translational NCS is as follows: *The largest off-origin peak in the Patterson function is 2.93% of the height of the origin peak. No significant pseudotranslation is detected.*

¹Intensities estimated from amplitudes.

²Theoretical values of $\langle |L| \rangle$, $\langle L^2 \rangle$ for acentric reflections are 0.5, 0.333 respectively for untwinned datasets, and 0.375, 0.2 for perfectly twinned datasets.

5 Model quality [i](#)

5.1 Standard geometry [i](#)

Bond lengths and bond angles in the following residue types are not validated in this section: 3QZ, HEM

The Z score for a bond length (or angle) is the number of standard deviations the observed value is removed from the expected value. A bond length (or angle) with $|Z| > 5$ is considered an outlier worth inspection. RMSZ is the root-mean-square of all Z scores of the bond lengths (or angles).

Mol	Chain	Bond lengths		Bond angles	
		RMSZ	# Z >5	RMSZ	# Z >5
1	A	0.35	0/3770	0.51	0/5102
1	B	0.37	0/3783	0.51	0/5121
1	C	0.39	0/3807	0.52	0/5152
1	D	0.37	0/3791	0.51	0/5132
All	All	0.37	0/15151	0.52	0/20507

There are no bond length outliers.

There are no bond angle outliers.

There are no chirality outliers.

There are no planarity outliers.

5.2 Too-close contacts [i](#)

In the following table, the Non-H and H(model) columns list the number of non-hydrogen atoms and hydrogen atoms in the chain respectively. The H(added) column lists the number of hydrogen atoms added and optimized by MolProbity. The Clashes column lists the number of clashes within the asymmetric unit, whereas Symm-Clashes lists symmetry-related clashes.

Mol	Chain	Non-H	H(model)	H(added)	Clashes	Symm-Clashes
1	A	3691	3782	3773	9	0
1	B	3703	3793	3781	9	0
1	C	3727	3739	3802	9	0
1	D	3711	3790	3785	6	0
2	A	43	30	30	2	0
2	B	43	30	30	1	0
2	C	43	30	30	2	0
2	D	43	30	30	2	0
3	A	24	30	30	2	0

Continued on next page...

Continued from previous page...

Mol	Chain	Non-H	H(model)	H(added)	Clashes	Symm-Clashes
3	B	24	30	30	0	0
3	C	24	30	30	0	0
3	D	24	30	30	0	0
4	A	40	0	0	1	0
4	B	36	0	0	0	0
4	C	53	0	0	1	0
4	D	32	0	0	0	0
All	All	15261	15344	15381	35	0

The all-atom clashscore is defined as the number of clashes found per 1000 atoms (including hydrogen atoms). The all-atom clashscore for this structure is 1.

All (35) close contacts within the same asymmetric unit are listed below, sorted by their clash magnitude.

Atom-1	Atom-2	Interatomic distance (Å)	Clash overlap (Å)
3:A:601:3QZ:HAA	3:A:601:3QZ:HAN	1.70	0.71
1:D:445:GLU:OE2	1:D:449:ARG:NH2	2.29	0.65
1:A:239:ARG:NH2	4:A:733:HOH:O	2.29	0.65
1:A:84:GLU:OE2	1:A:89:LYS:NZ	2.31	0.64
2:A:600:HEM:HBB2	2:A:600:HEM:HHC	1.80	0.62
2:A:600:HEM:HBC2	2:A:600:HEM:HHD	1.82	0.61
1:C:42:PHE:O	1:C:43:LEU:HG	2.03	0.59
1:B:303:GLY:HA2	2:B:600:HEM:HMC2	1.85	0.58
1:C:125:ARG:NH1	2:C:600:HEM:O1D	2.37	0.58
3:A:601:3QZ:HAA	3:A:601:3QZ:CAN	2.35	0.57
1:A:470:ASP:O	1:C:231:LYS:NZ	2.35	0.54
1:D:497:GLN:OE1	1:D:500:ARG:NH1	2.42	0.52
1:B:40:LEU:HD21	1:B:68:MET:HE1	1.92	0.51
1:A:347:ARG:NH2	1:A:354:GLU:OE1	2.44	0.51
1:C:48:HIS:HD2	4:C:734:HOH:O	1.94	0.51
1:D:474:PRO:HB3	1:D:489:PHE:CG	2.48	0.48
1:A:211:LYS:O	1:A:481:LYS:NZ	2.34	0.47
1:D:262:MET:SD	1:D:299:ILE:HD13	2.54	0.47
1:B:256:SER:OG	1:B:271:MET:SD	2.73	0.47
1:B:211:LYS:O	1:B:481:LYS:NZ	2.39	0.47
1:D:137:ASP:N	1:D:137:ASP:OD1	2.49	0.46
1:A:66:VAL:HG12	1:A:68:MET:HE2	1.99	0.44
1:B:237:LYS:NZ	1:B:241:ASP:OD2	2.50	0.44
1:A:351:LEU:HD13	1:A:424:GLN:HA	2.00	0.43
1:A:379:SER:OG	1:A:380:SER:N	2.49	0.43
1:B:169:PHE:HB3	1:B:170:PRO:HD3	1.99	0.43

Continued on next page...

Continued from previous page...

Atom-1	Atom-2	Interatomic distance (Å)	Clash overlap (Å)
1:D:303:GLY:HA2	2:D:600:HEM:HMC2	1.99	0.43
1:A:67:ARG:NH1	1:A:69:GLY:O	2.52	0.43
1:B:37:VAL:O	1:C:41:PRO:HD2	2.20	0.42
1:C:42:PHE:HE2	1:C:60:TYR:HH	1.67	0.41
1:B:331:GLU:OE2	1:B:351:LEU:N	2.54	0.41
1:C:303:GLY:HA2	2:C:600:HEM:HMC2	2.02	0.41
1:B:35:PRO:HD3	1:C:384:PHE:CE1	2.55	0.41
1:C:215:VAL:HG13	1:C:393:ILE:CD1	2.52	0.40
2:D:600:HEM:HMC2	2:D:600:HEM:HBC2	2.03	0.40

There are no symmetry-related clashes.

5.3 Torsion angles [i](#)

5.3.1 Protein backbone [i](#)

In the following table, the Percentiles column shows the percent Ramachandran outliers of the chain as a percentile score with respect to all X-ray entries followed by that with respect to entries of similar resolution.

The Analysed column shows the number of residues for which the backbone conformation was analysed, and the total number of residues.

Mol	Chain	Analysed	Favoured	Allowed	Outliers	Percentiles	
1	A	456/494 (92%)	441 (97%)	15 (3%)	0	100	100
1	B	460/494 (93%)	442 (96%)	18 (4%)	0	100	100
1	C	461/494 (93%)	450 (98%)	11 (2%)	0	100	100
1	D	461/494 (93%)	440 (95%)	21 (5%)	0	100	100
All	All	1838/1976 (93%)	1773 (96%)	65 (4%)	0	100	100

There are no Ramachandran outliers to report.

5.3.2 Protein sidechains [i](#)

In the following table, the Percentiles column shows the percent sidechain outliers of the chain as a percentile score with respect to all X-ray entries followed by that with respect to entries of similar resolution.

The Analysed column shows the number of residues for which the sidechain conformation was analysed, and the total number of residues.

Mol	Chain	Analysed	Rotameric	Outliers	Percentiles	
1	A	414/437 (95%)	406 (98%)	8 (2%)	57	72
1	B	415/437 (95%)	403 (97%)	12 (3%)	42	57
1	C	418/437 (96%)	409 (98%)	9 (2%)	52	66
1	D	416/437 (95%)	409 (98%)	7 (2%)	60	75
All	All	1663/1748 (95%)	1627 (98%)	36 (2%)	52	66

All (36) residues with a non-rotameric sidechain are listed below:

Mol	Chain	Res	Type
1	A	120	HIS
1	A	168	SER
1	A	201	TYR
1	A	207	ASP
1	A	216	ASP
1	A	217	LEU
1	A	239	ARG
1	A	300	PHE
1	B	109	ARG
1	B	187	SER
1	B	201	TYR
1	B	207	ASP
1	B	216	ASP
1	B	239	ARG
1	B	284	SER
1	B	285	GLU
1	B	296	ILE
1	B	300	PHE
1	B	449	ARG
1	B	484	PHE
1	C	56	LEU
1	C	98	GLN
1	C	199	GLN
1	C	201	TYR
1	C	239	ARG
1	C	256	SER
1	C	281	ASP
1	C	293	LEU
1	C	484	PHE
1	D	40	LEU
1	D	199	GLN
1	D	201	TYR
1	D	239	ARG

Continued on next page...

Continued from previous page...

Mol	Chain	Res	Type
1	D	300	PHE
1	D	464	ASP
1	D	484	PHE

Sometimes sidechains can be flipped to improve hydrogen bonding and reduce clashes. All (10) such sidechains are listed below:

Mol	Chain	Res	Type
1	A	202	ASN
1	B	50	HIS
1	B	140	GLN
1	B	202	ASN
1	B	407	HIS
1	C	50	HIS
1	C	202	ASN
1	D	50	HIS
1	D	160	HIS
1	D	202	ASN

5.3.3 RNA [i](#)

There are no RNA molecules in this entry.

5.4 Non-standard residues in protein, DNA, RNA chains [i](#)

There are no non-standard protein/DNA/RNA residues in this entry.

5.5 Carbohydrates [i](#)

There are no monosaccharides in this entry.

5.6 Ligand geometry [i](#)

8 ligands are modelled in this entry.

In the following table, the Counts columns list the number of bonds (or angles) for which Mogul statistics could be retrieved, the number of bonds (or angles) that are observed in the model and the number of bonds (or angles) that are defined in the Chemical Component Dictionary. The Link column lists molecule types, if any, to which the group is linked. The Z score for a bond length (or angle) is the number of standard deviations the observed value is removed from the

expected value. A bond length (or angle) with $|Z| > 2$ is considered an outlier worth inspection. RMSZ is the root-mean-square of all Z scores of the bond lengths (or angles).

Mol	Type	Chain	Res	Link	Bond lengths			Bond angles		
					Counts	RMSZ	# Z > 2	Counts	RMSZ	# Z > 2
2	HEM	D	600	1	41,50,50	1.93	8 (19%)	45,82,82	1.77	6 (13%)
3	3QZ	B	601	-	26,27,27	4.23	17 (65%)	41,45,45	3.81	18 (43%)
2	HEM	A	600	1	41,50,50	2.04	7 (17%)	45,82,82	1.78	9 (20%)
3	3QZ	C	601	-	26,27,27	4.24	17 (65%)	41,45,45	3.88	14 (34%)
2	HEM	C	600	1	41,50,50	1.98	8 (19%)	45,82,82	1.82	9 (20%)
3	3QZ	A	601	-	26,27,27	4.22	16 (61%)	41,45,45	3.82	13 (31%)
2	HEM	B	600	1	41,50,50	1.89	5 (12%)	45,82,82	1.66	6 (13%)
3	3QZ	D	601	-	26,27,27	4.32	18 (69%)	41,45,45	3.85	16 (39%)

In the following table, the Chirals column lists the number of chiral outliers, the number of chiral centers analysed, the number of these observed in the model and the number defined in the Chemical Component Dictionary. Similar counts are reported in the Torsion and Rings columns. '-' means no outliers of that kind were identified.

Mol	Type	Chain	Res	Link	Chirals	Torsions	Rings
2	HEM	D	600	1	-	3/12/54/54	-
3	3QZ	B	601	-	-	4/6/68/68	0/4/4/4
2	HEM	A	600	1	-	2/12/54/54	-
3	3QZ	C	601	-	-	4/6/68/68	0/4/4/4
2	HEM	C	600	1	-	2/12/54/54	-
3	3QZ	A	601	-	-	4/6/68/68	0/4/4/4
2	HEM	B	600	1	-	3/12/54/54	-
3	3QZ	D	601	-	-	4/6/68/68	0/4/4/4

All (96) bond length outliers are listed below:

Mol	Chain	Res	Type	Atoms	Z	Observed(Å)	Ideal(Å)
3	C	601	3QZ	CAK-CAT	10.57	1.71	1.53
3	B	601	3QZ	CAK-CAT	10.57	1.71	1.53
3	D	601	3QZ	CAK-CAT	10.19	1.70	1.53
3	A	601	3QZ	CAK-CAT	10.00	1.70	1.53
3	B	601	3QZ	CAO-CAX	9.41	1.69	1.54
3	A	601	3QZ	CAO-CAX	8.91	1.68	1.54
3	D	601	3QZ	CAO-CAX	8.70	1.68	1.54
3	C	601	3QZ	CAO-CAX	8.64	1.67	1.54
2	C	600	HEM	C3D-C2D	8.42	1.54	1.36

Continued on next page...

Continued from previous page...

Mol	Chain	Res	Type	Atoms	Z	Observed(Å)	Ideal(Å)
3	D	601	3QZ	CAN-CAK	8.25	1.71	1.53
3	C	601	3QZ	CAN-CAK	8.12	1.70	1.53
3	B	601	3QZ	CAN-CAK	8.03	1.70	1.53
2	A	600	HEM	C3D-C2D	8.00	1.53	1.36
3	A	601	3QZ	CAN-CAK	7.97	1.70	1.53
2	B	600	HEM	C3D-C2D	7.95	1.53	1.36
2	D	600	HEM	C3D-C2D	7.73	1.53	1.36
3	D	601	3QZ	CAV-CAT	-6.27	1.45	1.56
3	A	601	3QZ	CAJ-CAH	5.98	1.66	1.52
3	D	601	3QZ	CAJ-CAH	5.96	1.66	1.52
3	C	601	3QZ	CAV-CAT	-5.79	1.46	1.56
3	C	601	3QZ	CAJ-CAH	5.77	1.65	1.52
3	A	601	3QZ	CAV-CAT	-5.77	1.46	1.56
3	B	601	3QZ	CAJ-CAH	5.43	1.65	1.52
3	B	601	3QZ	CAV-CAT	-5.32	1.47	1.56
3	D	601	3QZ	CAJ-CAS	4.86	1.62	1.53
3	A	601	3QZ	CAW-CAU	-4.69	1.46	1.54
3	A	601	3QZ	CAJ-CAS	4.58	1.61	1.53
3	B	601	3QZ	CAJ-CAS	4.57	1.61	1.53
2	A	600	HEM	C3C-C2C	-4.48	1.34	1.40
3	C	601	3QZ	CAJ-CAS	4.39	1.61	1.53
3	D	601	3QZ	CAW-CAU	-4.33	1.46	1.54
3	C	601	3QZ	CAW-CAU	-4.24	1.46	1.54
3	B	601	3QZ	CAH-CAR	4.22	1.57	1.50
3	A	601	3QZ	CAH-CAR	4.16	1.57	1.50
3	D	601	3QZ	CAH-CAR	4.14	1.57	1.50
2	A	600	HEM	C3C-CAC	4.10	1.56	1.47
3	B	601	3QZ	CAW-CAU	-4.05	1.47	1.54
3	C	601	3QZ	CAH-CAR	4.02	1.57	1.50
3	D	601	3QZ	CAI-CAQ	3.96	1.58	1.49
2	D	600	HEM	C3C-CAC	3.93	1.55	1.47
3	A	601	3QZ	CAM-CAV	3.85	1.61	1.54
3	C	601	3QZ	CAV-CAR	-3.84	1.45	1.52
3	D	601	3QZ	CAM-CAV	3.83	1.61	1.54
3	D	601	3QZ	CAV-CAR	-3.82	1.45	1.52
2	C	600	HEM	C3C-CAC	3.81	1.55	1.47
2	B	600	HEM	C3C-C2C	-3.76	1.35	1.40
3	B	601	3QZ	CAI-CAQ	3.60	1.57	1.49
3	A	601	3QZ	CAV-CAR	-3.60	1.45	1.52
3	D	601	3QZ	CAS-CAT	-3.55	1.46	1.53
3	C	601	3QZ	CAS-CAT	-3.54	1.46	1.53
3	B	601	3QZ	CAG-CAQ	3.54	1.53	1.45

Continued on next page...

Continued from previous page...

Mol	Chain	Res	Type	Atoms	Z	Observed(Å)	Ideal(Å)
3	A	601	3QZ	CAS-CAT	-3.51	1.46	1.53
3	B	601	3QZ	CAM-CAV	3.48	1.60	1.54
3	B	601	3QZ	CAV-CAR	-3.45	1.46	1.52
2	D	600	HEM	FE-ND	3.39	2.13	1.96
3	C	601	3QZ	CAM-CAV	3.38	1.60	1.54
3	C	601	3QZ	CAI-CAQ	3.37	1.57	1.49
3	C	601	3QZ	CAG-CAQ	3.33	1.52	1.45
3	A	601	3QZ	CAG-CAQ	3.32	1.52	1.45
2	C	600	HEM	C3C-C2C	-3.29	1.35	1.40
2	B	600	HEM	C3C-CAC	3.29	1.54	1.47
3	B	601	3QZ	CAS-CAT	-3.24	1.47	1.53
2	D	600	HEM	C3C-C2C	-3.20	1.35	1.40
3	A	601	3QZ	CAI-CAQ	3.18	1.56	1.49
2	A	600	HEM	CAB-C3B	3.15	1.56	1.47
2	D	600	HEM	CAB-C3B	3.10	1.55	1.47
3	D	601	3QZ	CAG-CAQ	3.07	1.52	1.45
3	C	601	3QZ	CAN-CAW	-2.98	1.48	1.54
2	B	600	HEM	CAB-C3B	2.97	1.55	1.47
3	A	601	3QZ	CAN-CAW	-2.83	1.49	1.54
2	A	600	HEM	FE-NB	2.82	2.10	1.96
3	D	601	3QZ	CAM-CAI	2.80	1.59	1.53
3	D	601	3QZ	CAN-CAW	-2.76	1.49	1.54
2	C	600	HEM	CAB-C3B	2.72	1.54	1.47
2	B	600	HEM	FE-ND	2.66	2.10	1.96
2	C	600	HEM	FE-ND	2.66	2.10	1.96
2	A	600	HEM	FE-ND	2.63	2.09	1.96
3	C	601	3QZ	CAM-CAI	2.55	1.58	1.53
3	A	601	3QZ	CAO-CAL	2.51	1.62	1.54
3	A	601	3QZ	CAM-CAI	2.50	1.58	1.53
3	C	601	3QZ	CAA-CAP	2.49	1.56	1.50
3	B	601	3QZ	CAO-CAL	2.45	1.62	1.54
3	D	601	3QZ	CAO-CAL	2.40	1.62	1.54
3	B	601	3QZ	CAA-CAP	2.38	1.56	1.50
2	C	600	HEM	CAA-C2A	2.37	1.55	1.52
2	A	600	HEM	CAA-C2A	2.36	1.55	1.52
3	C	601	3QZ	CAO-CAL	2.36	1.62	1.54
3	B	601	3QZ	CAN-CAW	-2.30	1.50	1.54
3	B	601	3QZ	CAM-CAI	2.27	1.57	1.53
2	D	600	HEM	CAA-C2A	2.22	1.55	1.52
3	D	601	3QZ	CAA-CAP	2.20	1.55	1.50
2	C	600	HEM	CMB-C2B	2.18	1.55	1.50
3	D	601	3QZ	CAS-CAU	-2.08	1.49	1.53

Continued on next page...

Continued from previous page...

Mol	Chain	Res	Type	Atoms	Z	Observed(Å)	Ideal(Å)
2	C	600	HEM	CMD-C2D	2.06	1.55	1.50
2	D	600	HEM	CMD-C2D	2.05	1.55	1.50
2	D	600	HEM	CMB-C2B	2.00	1.55	1.50

All (91) bond angle outliers are listed below:

Mol	Chain	Res	Type	Atoms	Z	Observed(°)	Ideal(°)
3	A	601	3QZ	CAW-CAX-CAP	15.91	129.72	112.89
3	C	601	3QZ	CAW-CAX-CAP	15.50	129.29	112.89
3	B	601	3QZ	CAW-CAX-CAP	15.00	128.76	112.89
3	D	601	3QZ	CAW-CAX-CAP	14.71	128.45	112.89
3	B	601	3QZ	OAF-CAX-CAO	-8.53	90.79	110.34
3	C	601	3QZ	OAF-CAX-CAO	-8.45	90.95	110.34
3	D	601	3QZ	OAF-CAX-CAO	-8.31	91.28	110.34
3	A	601	3QZ	CAX-CAW-CAU	7.83	108.50	99.89
3	D	601	3QZ	OAF-CAX-CAW	-7.38	90.97	108.09
3	C	601	3QZ	CAX-CAW-CAU	7.35	107.97	99.89
3	A	601	3QZ	OAF-CAX-CAO	-7.14	93.96	110.34
3	A	601	3QZ	OAF-CAX-CAW	-7.08	91.65	108.09
3	D	601	3QZ	CAC-CAW-CAX	-6.87	100.95	109.14
3	C	601	3QZ	CAC-CAW-CAX	-6.86	100.97	109.14
3	B	601	3QZ	CAX-CAW-CAU	6.70	107.26	99.89
3	D	601	3QZ	CAX-CAW-CAU	6.56	107.11	99.89
3	A	601	3QZ	CAM-CAI-CAQ	-6.54	97.62	111.62
3	B	601	3QZ	OAF-CAX-CAW	-6.25	93.59	108.09
2	C	600	HEM	C4D-ND-C1D	6.17	111.44	105.07
2	D	600	HEM	C4D-ND-C1D	6.11	111.39	105.07
3	C	601	3QZ	OAF-CAX-CAW	-6.09	93.96	108.09
3	C	601	3QZ	CAM-CAI-CAQ	-5.96	98.86	111.62
3	B	601	3QZ	CAC-CAW-CAX	-5.72	102.32	109.14
3	D	601	3QZ	CAH-CAR-CAG	-5.71	111.32	120.87
2	B	600	HEM	C4D-ND-C1D	5.53	110.78	105.07
3	B	601	3QZ	CAM-CAI-CAQ	-5.51	99.82	111.62
2	A	600	HEM	C4D-ND-C1D	5.32	110.57	105.07
3	A	601	3QZ	CAC-CAW-CAX	-5.17	102.98	109.14
3	B	601	3QZ	CAL-CAU-CAS	-5.09	110.70	119.08
3	C	601	3QZ	CAL-CAU-CAS	-5.06	110.75	119.08
3	A	601	3QZ	CAL-CAU-CAS	-4.86	111.08	119.08
3	D	601	3QZ	CAL-CAU-CAS	-4.84	111.12	119.08
3	D	601	3QZ	CAH-CAR-CAV	4.75	125.54	116.77
3	B	601	3QZ	CAJ-CAH-CAR	-4.42	103.61	111.93
3	D	601	3QZ	CAL-CAU-CAW	4.36	109.58	103.73

Continued on next page...

Continued from previous page...

Mol	Chain	Res	Type	Atoms	Z	Observed(°)	Ideal(°)
3	D	601	3QZ	CAM-CAI-CAQ	-4.21	102.60	111.62
3	C	601	3QZ	CAL-CAU-CAW	4.13	109.27	103.73
3	B	601	3QZ	CAL-CAU-CAW	4.01	109.10	103.73
3	C	601	3QZ	CAH-CAR-CAG	-3.95	114.27	120.87
2	B	600	HEM	CMC-C2C-C3C	3.91	131.99	124.68
2	C	600	HEM	CMC-C2C-C3C	3.89	131.95	124.68
3	A	601	3QZ	CAH-CAR-CAG	-3.84	114.44	120.87
2	A	600	HEM	C4C-CHD-C1D	3.72	127.47	122.56
2	D	600	HEM	CMC-C2C-C3C	3.67	131.55	124.68
2	D	600	HEM	C4C-CHD-C1D	3.63	127.35	122.56
2	A	600	HEM	C4B-CHC-C1C	3.58	127.29	122.56
2	C	600	HEM	C4C-CHD-C1D	3.52	127.21	122.56
3	A	601	3QZ	CAH-CAR-CAV	3.51	123.25	116.77
3	C	601	3QZ	CAH-CAR-CAV	3.49	123.20	116.77
2	A	600	HEM	C3B-C2B-C1B	3.48	109.07	106.49
2	A	600	HEM	C1B-NB-C4B	3.45	108.64	105.07
3	A	601	3QZ	CAL-CAU-CAW	3.35	108.23	103.73
3	B	601	3QZ	CAH-CAJ-CAS	-3.34	105.64	111.69
3	C	601	3QZ	CAK-CAN-CAW	-3.30	107.18	112.84
3	B	601	3QZ	CAT-CAV-CAR	3.25	114.74	109.65
3	B	601	3QZ	CAH-CAR-CAG	-3.15	115.60	120.87
3	B	601	3QZ	CAH-CAR-CAV	3.12	122.52	116.77
2	C	600	HEM	C4B-CHC-C1C	3.04	126.58	122.56
2	B	600	HEM	CAA-CBA-CGA	-2.97	105.44	113.76
3	A	601	3QZ	CAJ-CAH-CAR	-2.91	106.45	111.93
3	C	601	3QZ	CAJ-CAH-CAR	-2.91	106.45	111.93
2	B	600	HEM	CMB-C2B-C1B	-2.86	120.68	125.04
2	D	600	HEM	CMB-C2B-C1B	-2.86	120.69	125.04
3	A	601	3QZ	CAK-CAN-CAW	-2.85	107.94	112.84
2	B	600	HEM	C4C-CHD-C1D	2.80	126.25	122.56
3	D	601	3QZ	CAK-CAN-CAW	-2.79	108.05	112.84
3	B	601	3QZ	CAJ-CAS-CAT	-2.74	107.09	110.49
2	A	600	HEM	CHC-C4B-C3B	2.65	128.62	124.57
3	B	601	3QZ	CAK-CAN-CAW	-2.52	108.51	112.84
2	D	600	HEM	C4B-CHC-C1C	2.51	125.87	122.56
2	D	600	HEM	C1B-NB-C4B	2.51	107.67	105.07
2	C	600	HEM	CMB-C2B-C1B	-2.51	121.22	125.04
3	B	601	3QZ	CAI-CAM-CAV	-2.47	108.80	113.45
2	C	600	HEM	C1B-NB-C4B	2.46	107.62	105.07
2	C	600	HEM	CBA-CAA-C2A	-2.41	108.51	112.62
2	A	600	HEM	CMA-C3A-C4A	-2.39	124.80	128.46
3	D	601	3QZ	CAK-CAT-CAS	-2.33	108.40	111.75

Continued on next page...

Continued from previous page...

Mol	Chain	Res	Type	Atoms	Z	Observed(°)	Ideal(°)
2	C	600	HEM	CMA-C3A-C4A	-2.31	124.92	128.46
3	C	601	3QZ	CAJ-CAS-CAU	-2.26	108.23	112.08
3	A	601	3QZ	CAK-CAT-CAS	-2.26	108.50	111.75
3	B	601	3QZ	OAD-CAP-CAA	-2.22	117.03	121.35
2	B	600	HEM	C4B-CHC-C1C	2.21	125.48	122.56
3	D	601	3QZ	CAC-CAW-CAN	-2.21	106.60	109.73
3	B	601	3QZ	CAM-CAV-CAT	-2.16	105.71	108.73
3	D	601	3QZ	CAC-CAW-CAU	2.15	115.96	111.80
2	A	600	HEM	CHB-C1B-NB	2.09	126.97	124.38
3	C	601	3QZ	CAK-CAT-CAS	-2.09	108.75	111.75
3	D	601	3QZ	CAO-CAX-CAW	2.07	105.14	103.20
3	D	601	3QZ	CAL-CAO-CAX	-2.06	102.45	106.00
2	C	600	HEM	C4A-C3A-C2A	2.05	108.42	107.00
2	A	600	HEM	C2B-C1B-NB	-2.04	107.42	109.84

There are no chirality outliers.

All (26) torsion outliers are listed below:

Mol	Chain	Res	Type	Atoms
3	A	601	3QZ	CAA-CAP-CAX-CAW
3	A	601	3QZ	OAD-CAP-CAX-CAW
3	B	601	3QZ	CAA-CAP-CAX-CAO
3	B	601	3QZ	CAA-CAP-CAX-CAW
3	B	601	3QZ	OAD-CAP-CAX-CAO
3	B	601	3QZ	OAD-CAP-CAX-CAW
3	C	601	3QZ	CAA-CAP-CAX-CAW
3	C	601	3QZ	OAD-CAP-CAX-CAW
3	D	601	3QZ	CAA-CAP-CAX-CAW
3	D	601	3QZ	OAD-CAP-CAX-CAW
3	C	601	3QZ	OAD-CAP-CAX-CAO
3	D	601	3QZ	CAA-CAP-CAX-CAO
3	D	601	3QZ	OAD-CAP-CAX-CAO
2	A	600	HEM	C4B-C3B-CAB-CBB
3	A	601	3QZ	CAA-CAP-CAX-OAF
3	A	601	3QZ	OAD-CAP-CAX-OAF
2	A	600	HEM	C1A-C2A-CAA-CBA
3	C	601	3QZ	CAA-CAP-CAX-CAO
2	B	600	HEM	CAA-CBA-CGA-O2A
2	C	600	HEM	CAA-CBA-CGA-O2A
2	B	600	HEM	CAA-CBA-CGA-O1A
2	C	600	HEM	CAA-CBA-CGA-O1A
2	B	600	HEM	CAD-CBD-CGD-O1D

Continued on next page...

Continued from previous page...

Mol	Chain	Res	Type	Atoms
2	D	600	HEM	CAD-CBD-CGD-O2D
2	D	600	HEM	CAA-CBA-CGA-O1A
2	D	600	HEM	CAA-CBA-CGA-O2A

There are no ring outliers.

5 monomers are involved in 9 short contacts:

Mol	Chain	Res	Type	Clashes	Symm-Clashes
2	D	600	HEM	2	0
2	A	600	HEM	2	0
2	C	600	HEM	2	0
3	A	601	3QZ	2	0
2	B	600	HEM	1	0

The following is a two-dimensional graphical depiction of Mogul quality analysis of bond lengths, bond angles, torsion angles, and ring geometry for all instances of the Ligand of Interest. In addition, ligands with molecular weight > 250 and outliers as shown on the validation Tables will also be included. For torsion angles, if less than 5% of the Mogul distribution of torsion angles is within 10 degrees of the torsion angle in question, then that torsion angle is considered an outlier. Any bond that is central to one or more torsion angles identified as an outlier by Mogul will be highlighted in the graph. For rings, the root-mean-square deviation (RMSD) between the ring in question and similar rings identified by Mogul is calculated over all ring torsion angles. If the average RMSD is greater than 60 degrees and the minimal RMSD between the ring in question and any Mogul-identified rings is also greater than 60 degrees, then that ring is considered an outlier. The outliers are highlighted in purple. The color gray indicates Mogul did not find sufficient equivalents in the CSD to analyse the geometry.

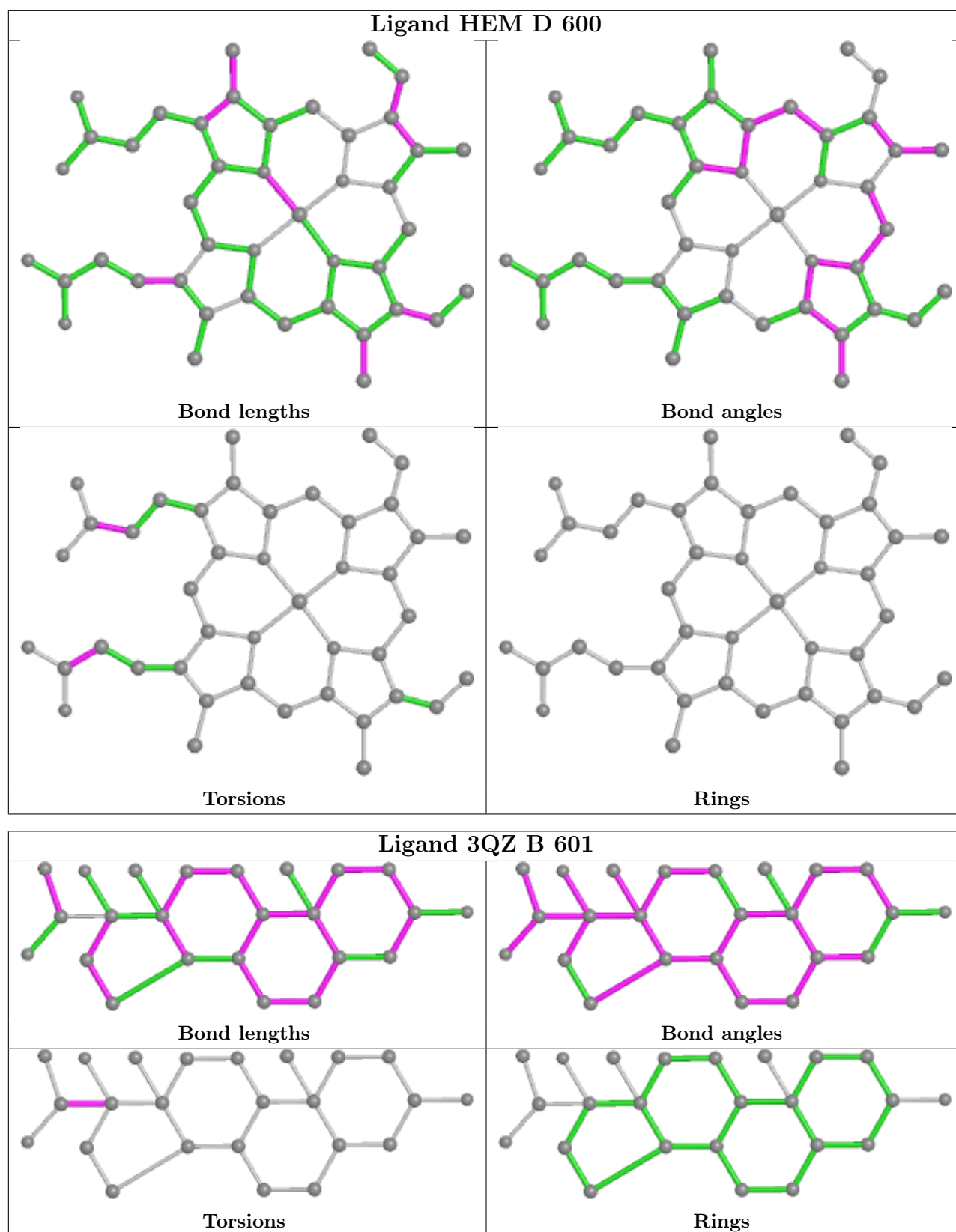

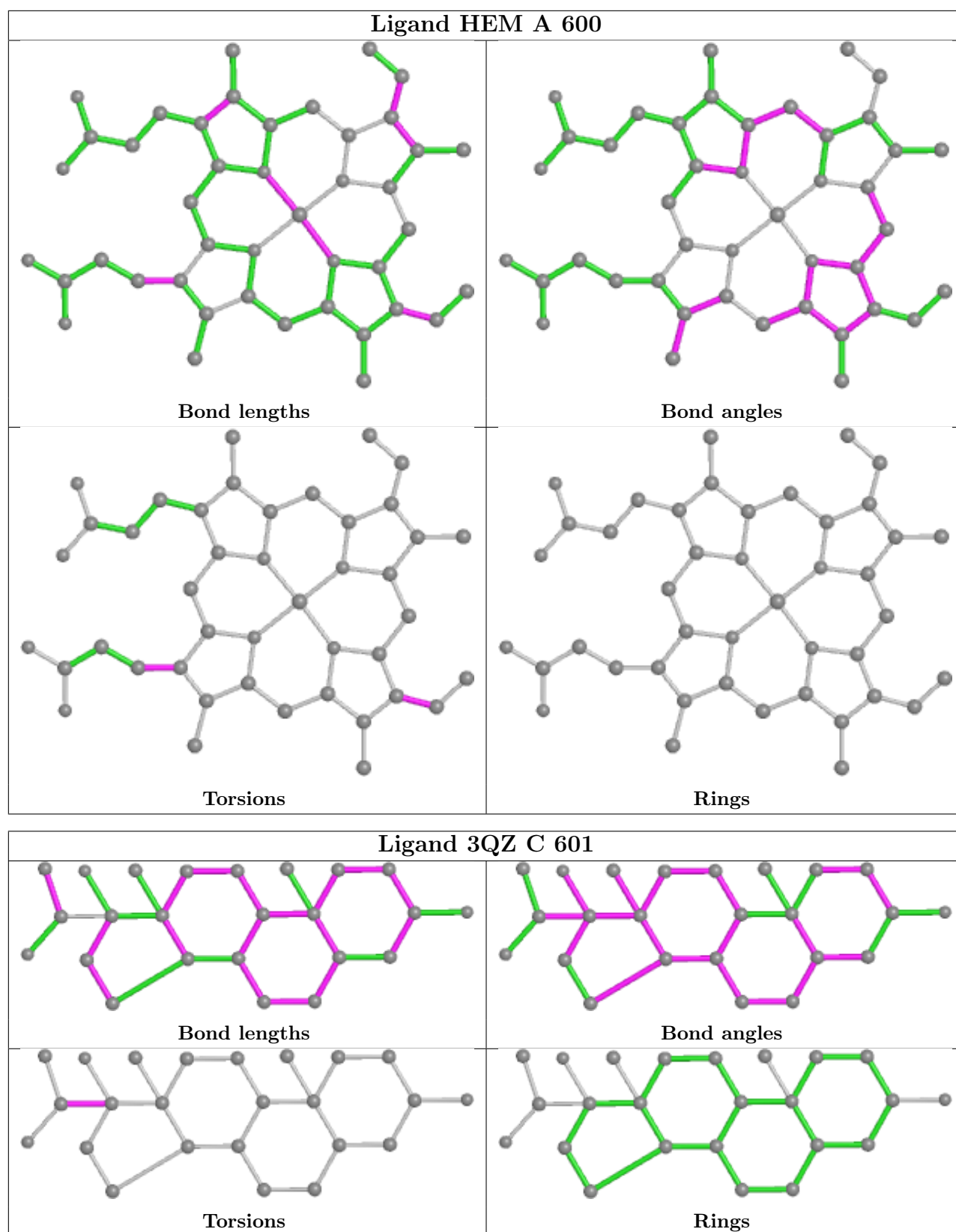

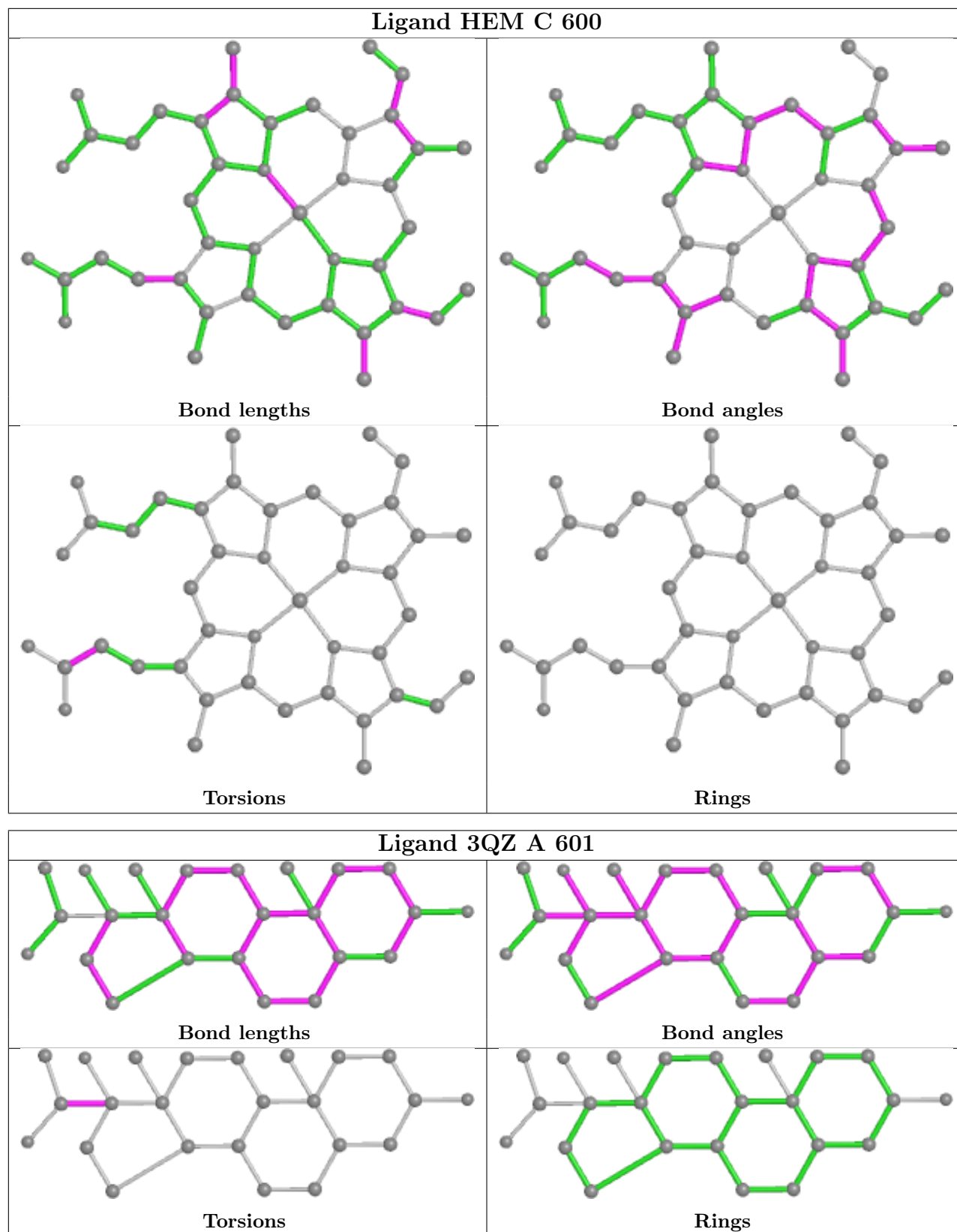

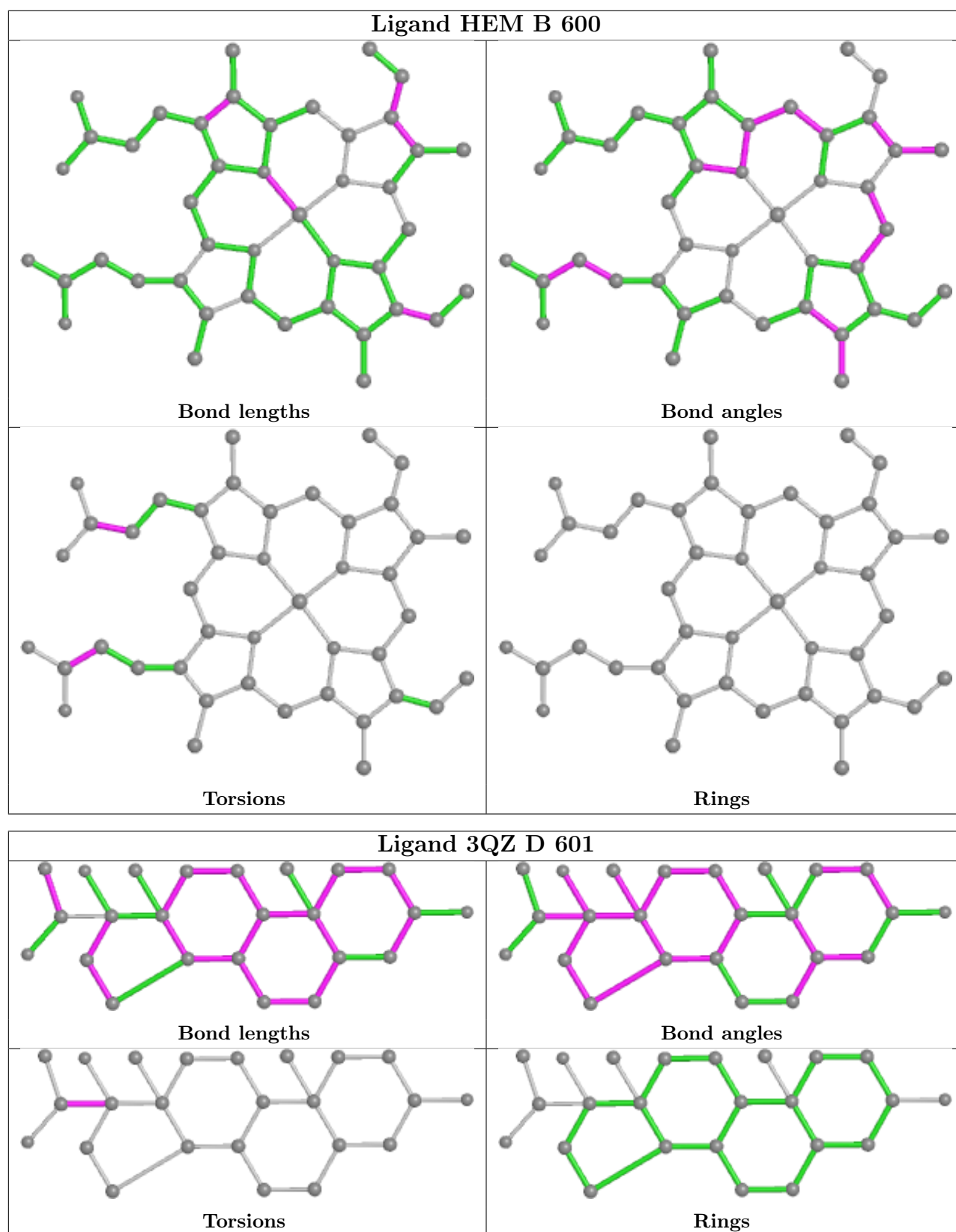

5.7 Other polymers [i](#)

There are no such residues in this entry.

5.8 Polymer linkage issues [i](#)

There are no chain breaks in this entry.

6 Fit of model and data

6.1 Protein, DNA and RNA chains

In the following table, the column labelled ‘#RSRZ> 2’ contains the number (and percentage) of RSRZ outliers, followed by percent RSRZ outliers for the chain as percentile scores relative to all X-ray entries and entries of similar resolution. The OWAB column contains the minimum, median, 95th percentile and maximum values of the occupancy-weighted average B-factor per residue. The column labelled ‘Q< 0.9’ lists the number of (and percentage) of residues with an average occupancy less than 0.9.

Mol	Chain	Analysed	<RSRZ>	#RSRZ>2	OWAB(Å ²)	Q<0.9
1	A	462/494 (93%)	0.44	45 (9%) 7 9	34, 50, 78, 107	0
1	B	464/494 (93%)	0.39	31 (6%) 17 21	34, 48, 76, 105	0
1	C	467/494 (94%)	0.36	32 (6%) 16 20	33, 47, 73, 92	0
1	D	465/494 (94%)	0.41	29 (6%) 20 24	34, 49, 76, 107	0
All	All	1858/1976 (94%)	0.40	137 (7%) 14 18	33, 49, 77, 107	0

All (137) RSRZ outliers are listed below:

Mol	Chain	Res	Type	RSRZ
1	A	271	MET	7.6
1	D	139	ASP	5.3
1	B	139	ASP	5.1
1	C	280	PRO	4.9
1	A	140	GLN	4.8
1	A	302	ALA	4.8
1	B	140	GLN	4.5
1	A	283	ASP	4.5
1	A	255	ARG	4.3
1	C	366	VAL	4.2
1	D	140	GLN	4.1
1	D	469	ASP	3.9
1	A	135	PHE	3.8
1	D	470	ASP	3.8
1	A	137	ASP	3.7
1	B	302	ALA	3.7
1	C	134	LEU	3.6
1	C	367	ALA	3.6
1	A	304	VAL	3.6
1	C	140	GLN	3.5
1	A	257	ASP	3.5

Continued on next page...

Continued from previous page...

Mol	Chain	Res	Type	RSRZ
1	B	253	LYS	3.4
1	B	301	GLY	3.4
1	C	45	ARG	3.4
1	B	304	VAL	3.3
1	C	469	ASP	3.3
1	C	304	VAL	3.2
1	C	365	PRO	3.2
1	B	303	GLY	3.2
1	C	483	VAL	3.2
1	A	245	LYS	3.2
1	D	136	LYS	3.2
1	A	306	THR	3.1
1	D	42	PHE	3.1
1	A	249	ASN	3.1
1	A	134	LEU	3.1
1	C	308	THR	3.1
1	C	484	PHE	3.1
1	B	255	ARG	3.1
1	D	306	THR	3.1
1	C	306	THR	3.1
1	B	366	VAL	3.1
1	D	43	LEU	3.0
1	B	254	PHE	3.0
1	A	250	TYR	3.0
1	B	306	THR	3.0
1	C	368	PRO	2.9
1	A	332	ILE	2.9
1	D	365	PRO	2.9
1	A	254	PHE	2.9
1	A	303	GLY	2.9
1	C	370	LEU	2.9
1	D	247	LEU	2.9
1	C	383	GLU	2.9
1	A	267	MET	2.8
1	A	289	ASP	2.8
1	B	138	GLY	2.8
1	A	497	GLN	2.8
1	B	252	GLU	2.8
1	D	163	GLN	2.8
1	C	307	THR	2.8
1	C	309	SER	2.7
1	A	270	LYS	2.7

Continued on next page...

Continued from previous page...

Mol	Chain	Res	Type	RSRZ
1	B	137	ASP	2.7
1	D	271	MET	2.7
1	C	482	VAL	2.7
1	A	273	SER	2.6
1	A	442	CYS	2.6
1	D	442	CYS	2.6
1	B	283	ASP	2.6
1	D	46	HIS	2.6
1	A	247	LEU	2.6
1	A	136	LYS	2.6
1	D	472	GLN	2.6
1	B	144	LYS	2.5
1	C	369	MET	2.5
1	B	307	THR	2.5
1	C	213	SER	2.5
1	C	130	ALA	2.5
1	A	337	GLY	2.5
1	B	300	PHE	2.5
1	C	136	LYS	2.5
1	B	367	ALA	2.5
1	B	297	GLY	2.5
1	C	313	TRP	2.5
1	D	370	LEU	2.4
1	A	483	VAL	2.4
1	A	435	PHE	2.4
1	C	276	GLY	2.4
1	B	308	THR	2.4
1	D	134	LEU	2.4
1	A	500	ARG	2.4
1	B	338	PHE	2.4
1	A	258	SER	2.4
1	A	284	SER	2.4
1	D	45	ARG	2.4
1	A	252	GLU	2.4
1	B	217	LEU	2.4
1	C	311	VAL	2.3
1	A	367	ALA	2.3
1	A	285	GLU	2.3
1	A	248	GLU	2.3
1	B	271	MET	2.3
1	C	442	CYS	2.3
1	A	301	GLY	2.3

Continued on next page...

Continued from previous page...

Mol	Chain	Res	Type	RSRZ
1	A	434	PRO	2.3
1	C	310	VAL	2.3
1	D	436	GLY	2.3
1	A	499	TRP	2.3
1	D	435	PHE	2.2
1	B	247	LEU	2.2
1	C	305	GLU	2.2
1	C	46	HIS	2.2
1	A	444	GLY	2.2
1	B	248	GLU	2.2
1	A	253	LYS	2.2
1	B	482	VAL	2.2
1	D	367	ALA	2.2
1	C	396	LEU	2.2
1	D	468	PRO	2.2
1	D	483	VAL	2.2
1	D	165	ILE	2.2
1	A	286	LEU	2.2
1	B	503	GLN	2.1
1	D	471	GLY	2.1
1	C	302	ALA	2.1
1	D	133	ALA	2.1
1	B	134	LEU	2.1
1	D	383	GLU	2.1
1	B	365	PRO	2.1
1	A	498	ALA	2.0
1	D	368	PRO	2.0
1	A	32	LEU	2.0
1	A	123	LEU	2.0
1	A	263	LEU	2.0
1	D	274	ASP	2.0
1	B	257	ASP	2.0

6.2 Non-standard residues in protein, DNA, RNA chains [i](#)

There are no non-standard protein/DNA/RNA residues in this entry.

6.3 Carbohydrates [i](#)

There are no monosaccharides in this entry.

6.4 Ligands [i](#)

In the following table, the Atoms column lists the number of modelled atoms in the group and the number defined in the chemical component dictionary. The B-factors column lists the minimum, median, 95th percentile and maximum values of B factors of atoms in the group. The column labelled 'Q<0.9' lists the number of atoms with occupancy less than 0.9.

Mol	Type	Chain	Res	Atoms	RSCC	RSR	B-factors(Å ²)	Q<0.9
3	3QZ	D	601	24/24	0.96	0.26	31,44,56,58	0
3	3QZ	C	601	24/24	0.97	0.26	35,49,58,65	0
3	3QZ	B	601	24/24	0.97	0.29	45,54,61,69	0
2	HEM	D	600	43/43	0.98	0.31	31,43,53,67	0
3	3QZ	A	601	24/24	0.98	0.32	43,60,72,74	0
2	HEM	A	600	43/43	0.98	0.33	29,42,55,66	0
2	HEM	B	600	43/43	0.98	0.28	31,42,57,70	0
2	HEM	C	600	43/43	0.98	0.30	31,41,52,61	0

The following is a graphical depiction of the model fit to experimental electron density of all instances of the Ligand of Interest. In addition, ligands with molecular weight > 250 and outliers as shown on the geometry validation Tables will also be included. Each fit is shown from different orientation to approximate a three-dimensional view.

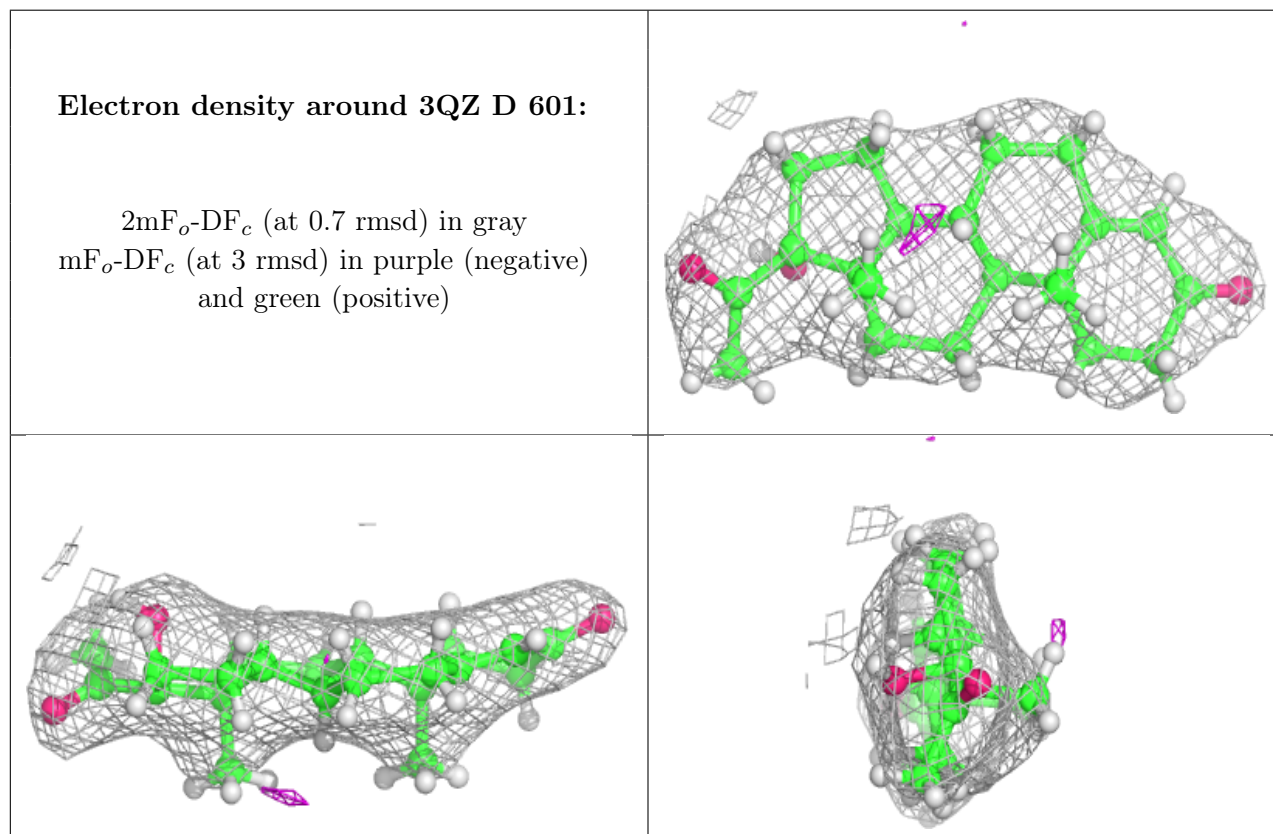

Electron density around 3QZ C 601:

$2mF_o-DF_c$ (at 0.7 rmsd) in gray
 mF_o-DF_c (at 3 rmsd) in purple (negative)
and green (positive)

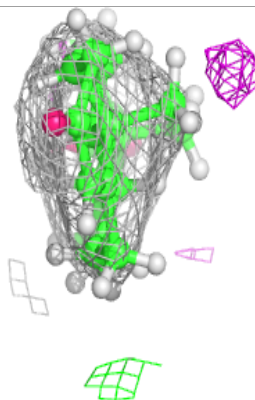
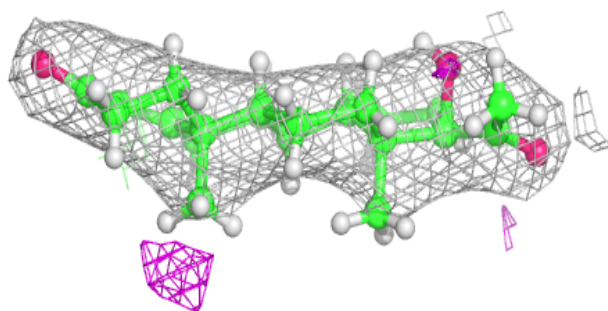
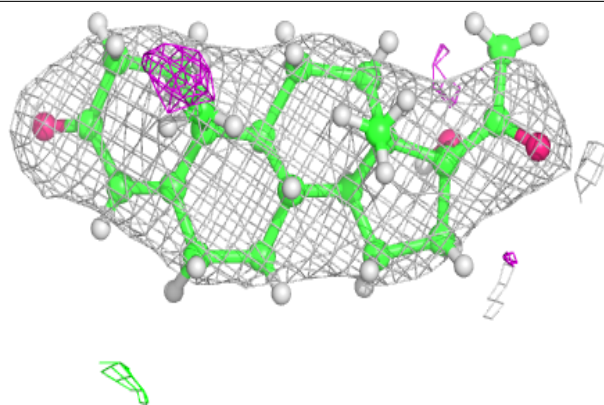
**Electron density around 3QZ B 601:**

$2mF_o-DF_c$ (at 0.7 rmsd) in gray
 mF_o-DF_c (at 3 rmsd) in purple (negative)
and green (positive)

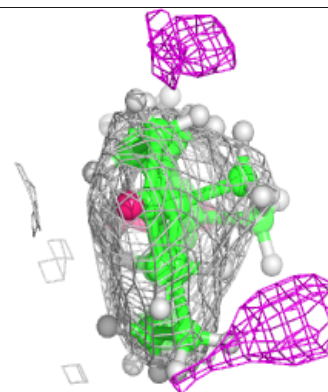
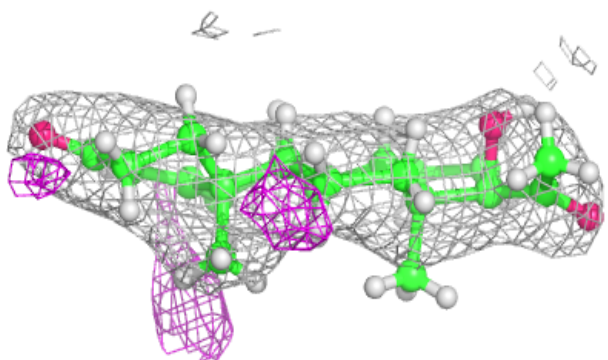
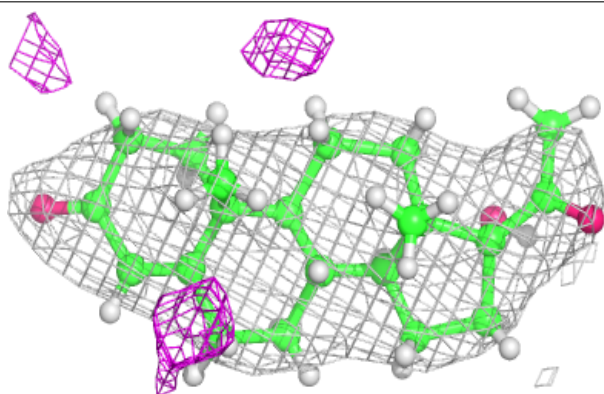

Electron density around HEM D 600:

$2mF_o-DF_c$ (at 0.7 rmsd) in gray
 mF_o-DF_c (at 3 rmsd) in purple (negative)
and green (positive)

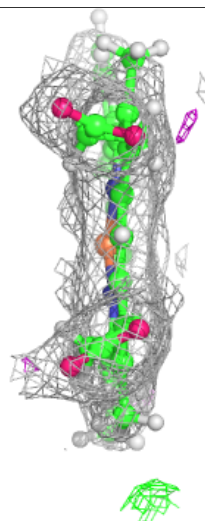
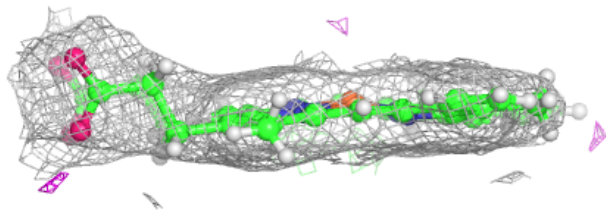
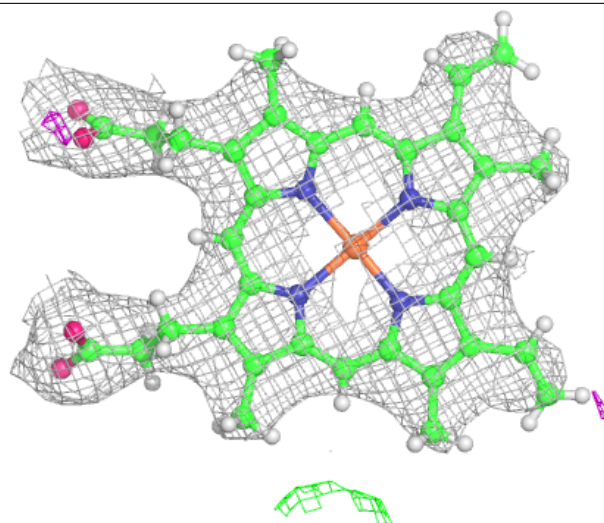

Electron density around 3QZ A 601:

$2mF_o-DF_c$ (at 0.7 rmsd) in gray
 mF_o-DF_c (at 3 rmsd) in purple (negative)
and green (positive)

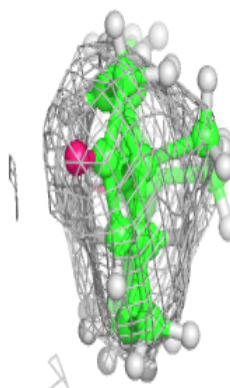
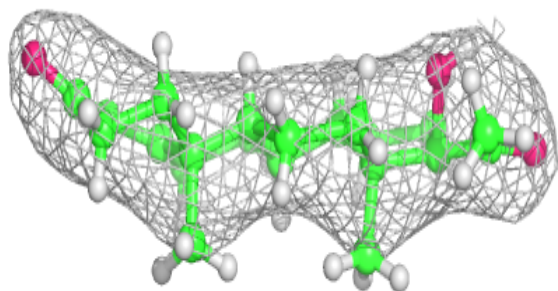
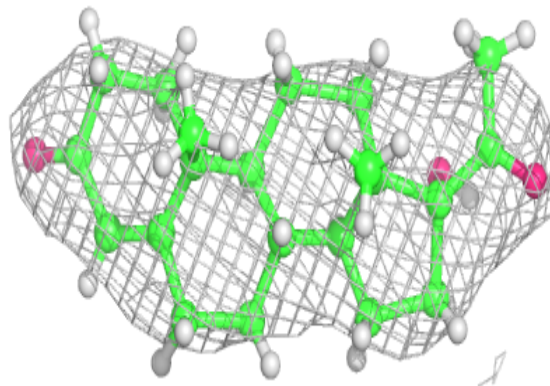

Electron density around HEM A 600:

$2mF_o-DF_c$ (at 0.7 rmsd) in gray
 mF_o-DF_c (at 3 rmsd) in purple (negative)
and green (positive)

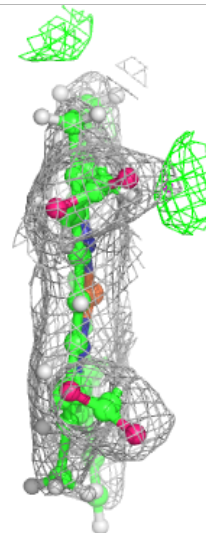
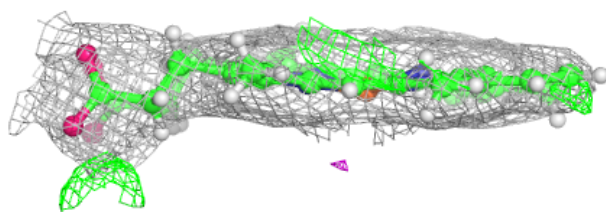
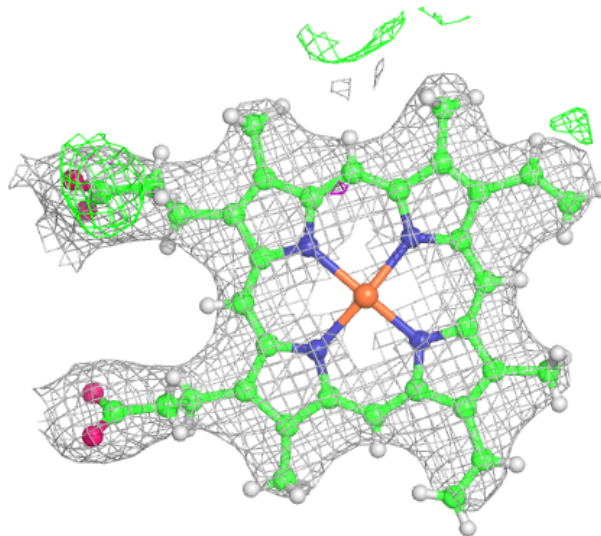

Electron density around HEM B 600:

$2mF_o-DF_c$ (at 0.7 rmsd) in gray
 mF_o-DF_c (at 3 rmsd) in purple (negative)
and green (positive)

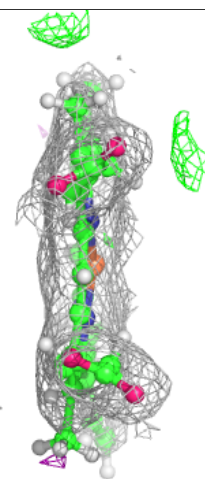
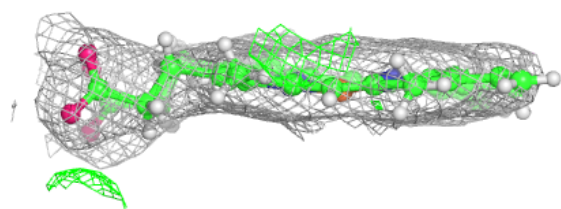
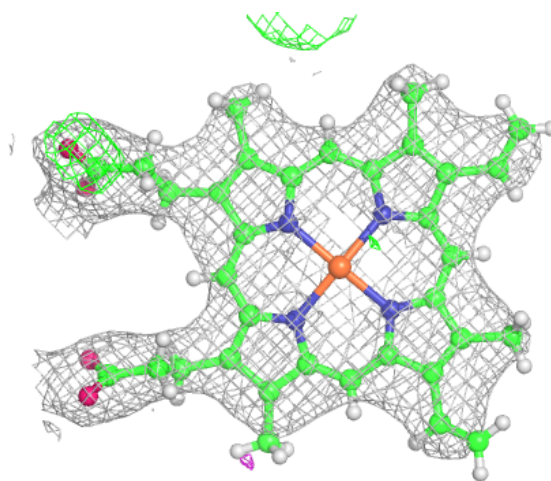

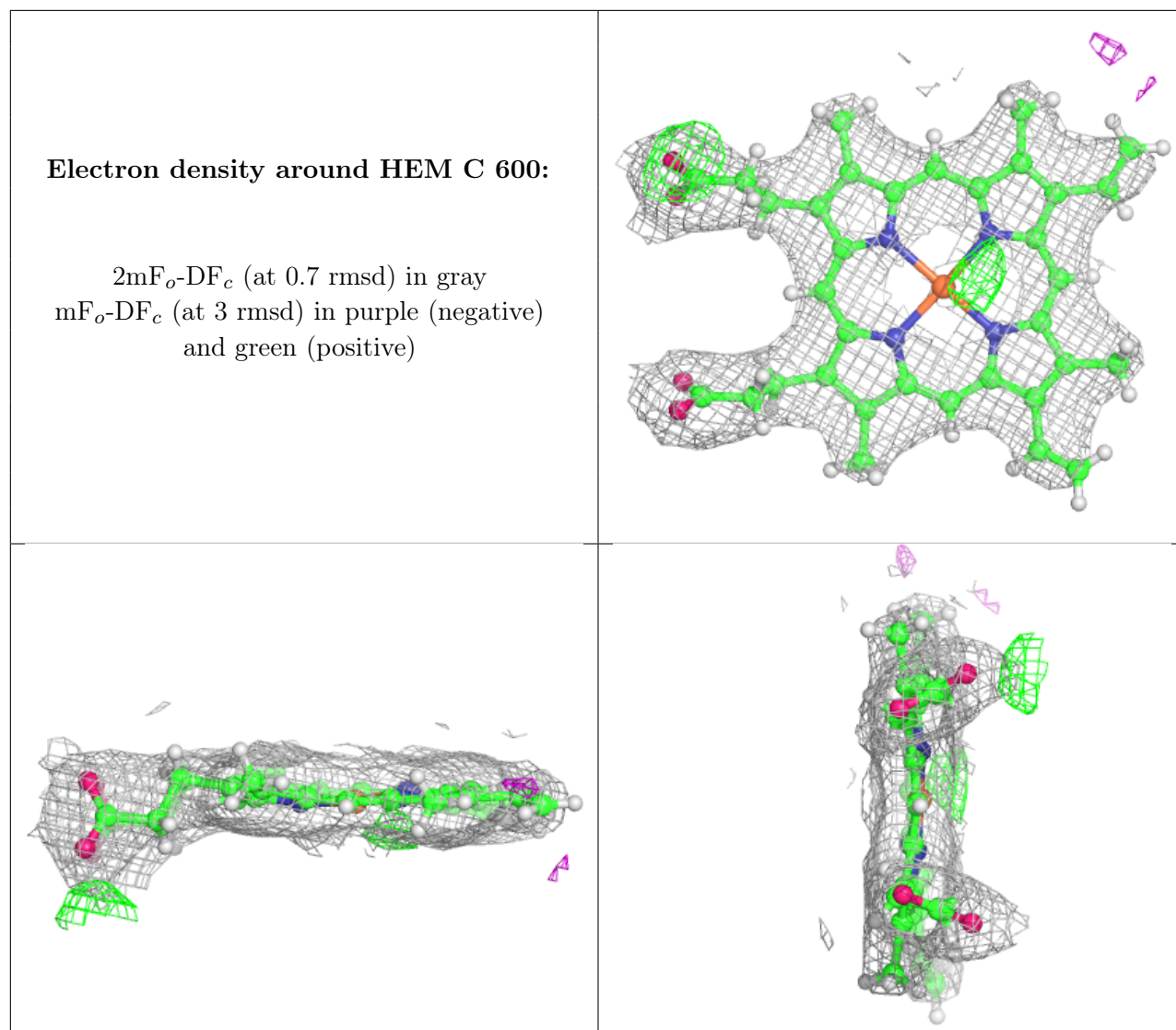

6.5 Other polymers [i](#)

There are no such residues in this entry.