



wwPDB X-ray Structure Validation Summary Report ⓘ

May 15, 2020 – 02:23 pm BST

PDB ID : 4LQL
Title : Crystal structure of L-arabinose isomerase from *Lactobacillus fermentum*
CGMCC2921
Authors : Xu, Z.
Deposited on : 2013-07-19
Resolution : 3.23 Å(reported)

This is a wwPDB X-ray Structure Validation Summary Report for a publicly released PDB entry.

We welcome your comments at validation@mail.wwpdb.org

A user guide is available at

<https://www.wwpdb.org/validation/2017/XrayValidationReportHelp>

with specific help available everywhere you see the ⓘ symbol.

The following versions of software and data (see [references ⓘ](#)) were used in the production of this report:

MolProbity : 4.02b-467
Xtriage (Phenix) : 1.13
EDS : 2.11
Percentile statistics : 20191225.v01 (using entries in the PDB archive December 25th 2019)
Refmac : 5.8.0158
CCP4 : 7.0.044 (Gargrove)
Ideal geometry (proteins) : Engh & Huber (2001)
Ideal geometry (DNA, RNA) : Parkinson et al. (1996)
Validation Pipeline (wwPDB-VP) : 2.11

1 Overall quality at a glance

The following experimental techniques were used to determine the structure:

X-RAY DIFFRACTION

The reported resolution of this entry is 3.23 Å.

Percentile scores (ranging between 0-100) for global validation metrics of the entry are shown in the following graphic. The table shows the number of entries on which the scores are based.

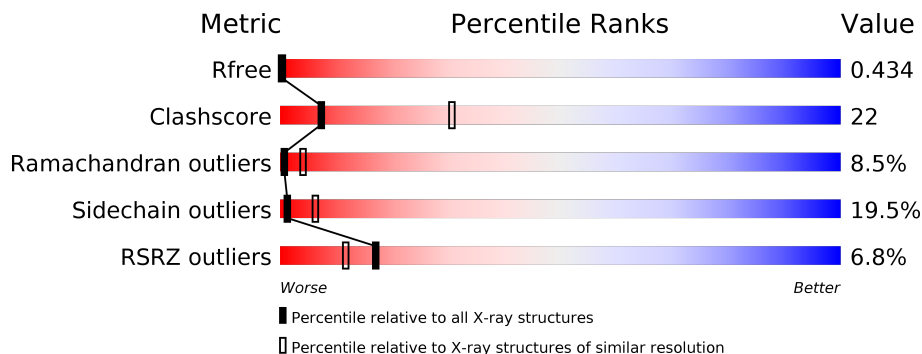

Metric	Whole archive (#Entries)	Similar resolution (#Entries, resolution range(Å))
R_{free}	130704	1619 (3.28-3.20)
Clashscore	141614	1755 (3.28-3.20)
Ramachandran outliers	138981	1728 (3.28-3.20)
Sidechain outliers	138945	1727 (3.28-3.20)
RSRZ outliers	127900	1567 (3.28-3.20)

The table below summarises the geometric issues observed across the polymeric chains and their fit to the electron density. The red, orange, yellow and green segments on the lower bar indicate the fraction of residues that contain outliers for ≥ 3 , 2, 1 and 0 types of geometric quality criteria respectively. A grey segment represents the fraction of residues that are not modelled. The numeric value for each fraction is indicated below the corresponding segment, with a dot representing fractions $\leq 5\%$. The upper red bar (where present) indicates the fraction of residues that have poor fit to the electron density. The numeric value is given above the bar.

Mol	Chain	Length	Quality of chain
1	A	474	 8% 57% 36% 7%
1	B	474	 4% 54% 37% 8%
1	C	474	 5% 61% 33% 5%
1	D	474	 8% 60% 33% 7%
1	E	474	 8% 51% 40% 8%
1	F	474	 7% 55% 39% 6%

2 Entry composition

There is only 1 type of molecule in this entry. The entry contains 18516 atoms, of which 0 are hydrogens and 0 are deuteriums.

In the tables below, the ZeroOcc column contains the number of atoms modelled with zero occupancy, the AltConf column contains the number of residues with at least one atom in alternate conformation and the Trace column contains the number of residues modelled with at most 2 atoms.

- Molecule 1 is a protein called L-arabinose isomerase.

Mol	Chain	Residues	Atoms					ZeroOcc	AltConf	Trace
			Total	C	N	O	S			
1	A	474	3111	1999	538	566	8	0	0	0
1	B	474	3130	2013	539	570	8	0	0	0
1	C	474	3017	1936	517	556	8	0	0	0
1	D	474	3111	1999	538	566	8	0	0	0
1	E	474	3130	2013	539	570	8	0	0	0
1	F	474	3017	1936	517	556	8	0	0	0

3 Residue-property plots [i](#)

These plots are drawn for all protein, RNA and DNA chains in the entry. The first graphic for a chain summarises the proportions of the various outlier classes displayed in the second graphic. The second graphic shows the sequence view annotated by issues in geometry and electron density. Residues are color-coded according to the number of geometric quality criteria for which they contain at least one outlier: green = 0, yellow = 1, orange = 2 and red = 3 or more. A red dot above a residue indicates a poor fit to the electron density ($RSRZ > 2$). Stretches of 2 or more consecutive residues without any outlier are shown as a green connector. Residues present in the sample, but not in the model, are shown in grey.

- Molecule 1: L-arabinose isomerase

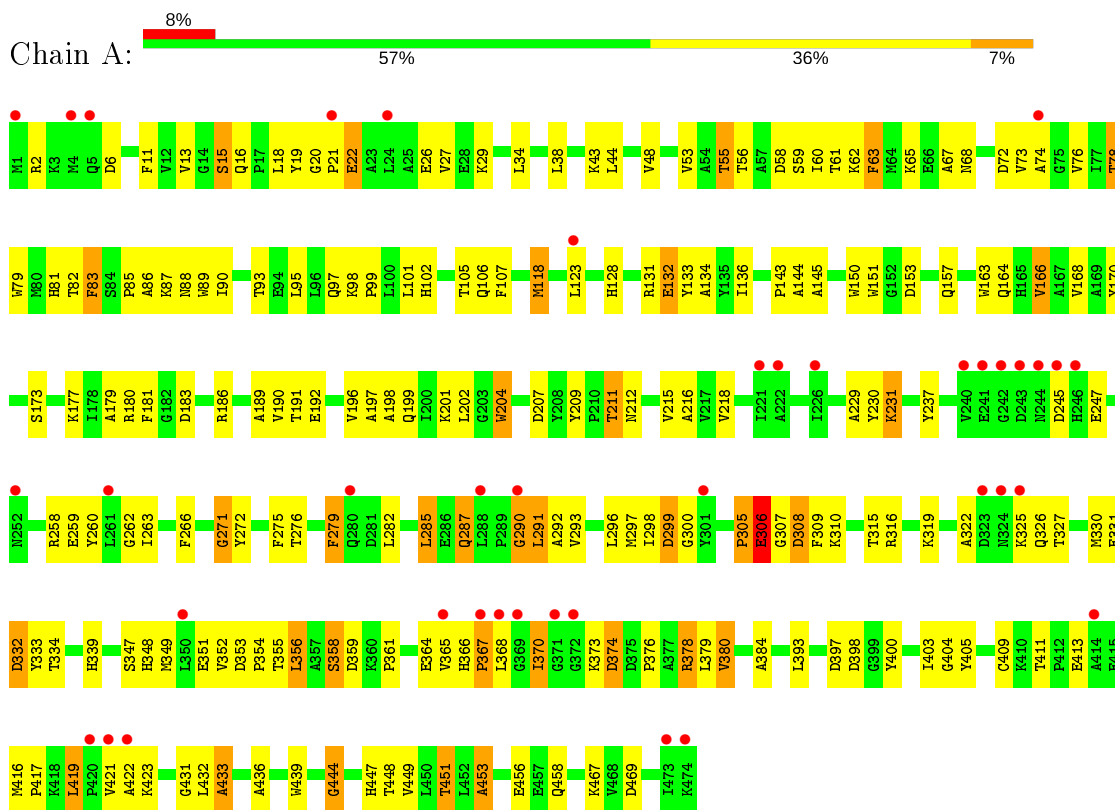

- Molecule 1: L-arabinose isomerase

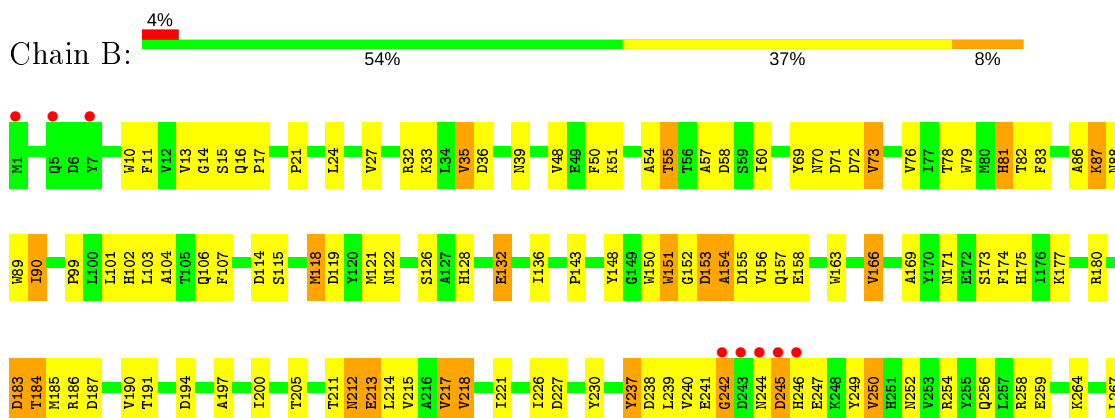

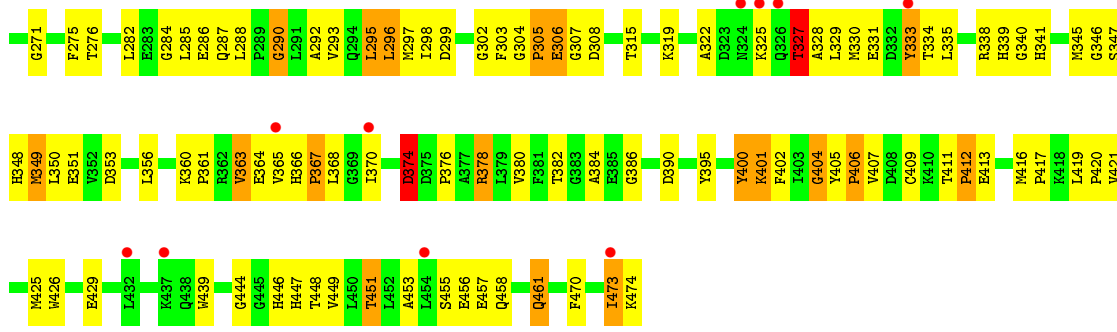

• Molecule 1: L-arabinose isomerase

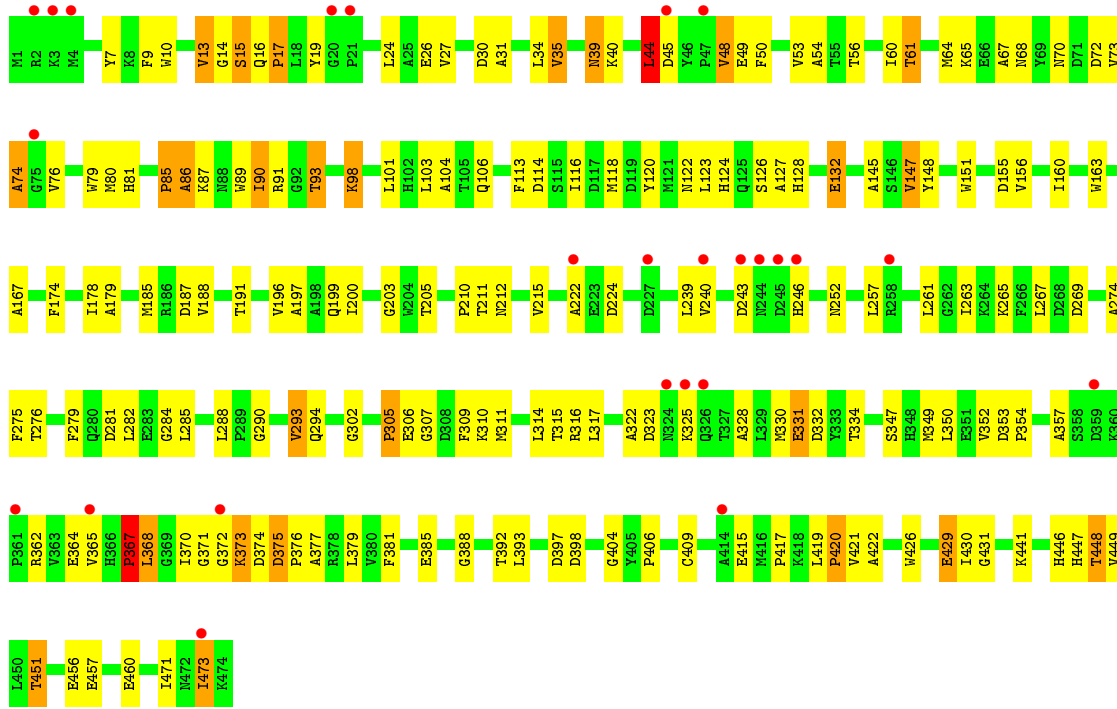

• Molecule 1: L-arabinose isomerase

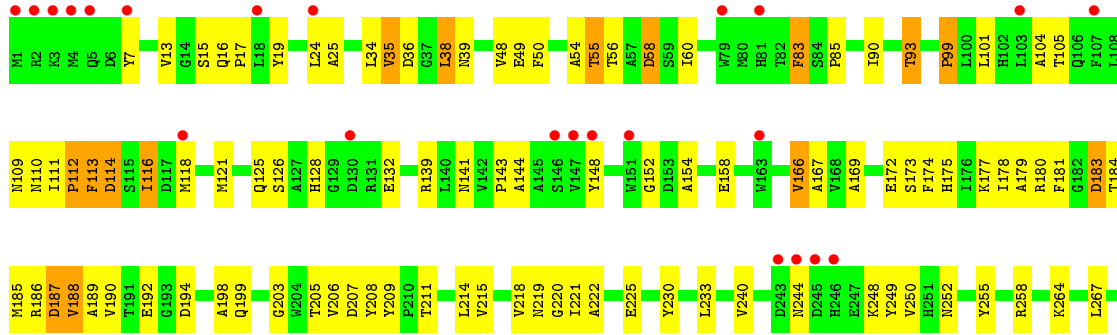

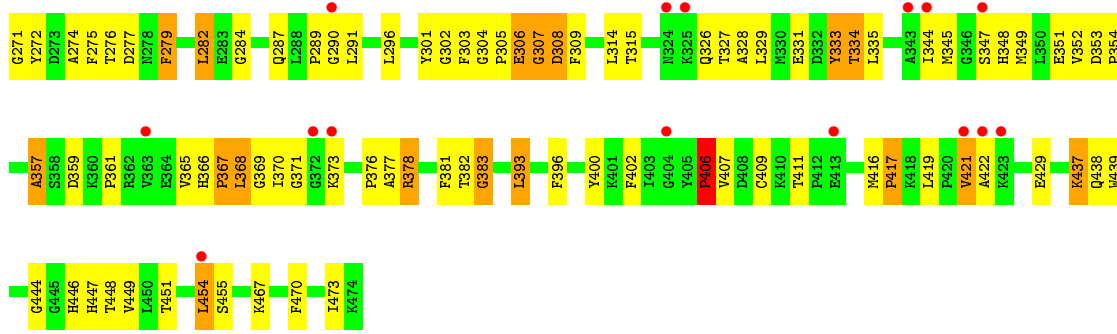

• Molecule 1: L-arabinose isomerase

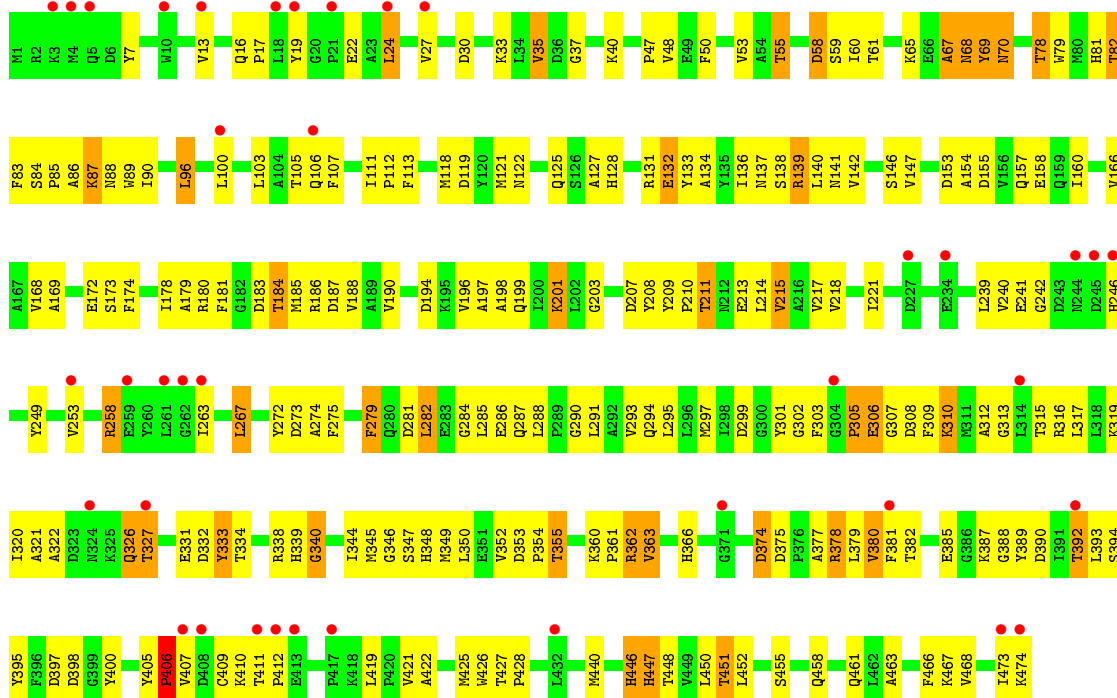

• Molecule 1: L-arabinose isomerase

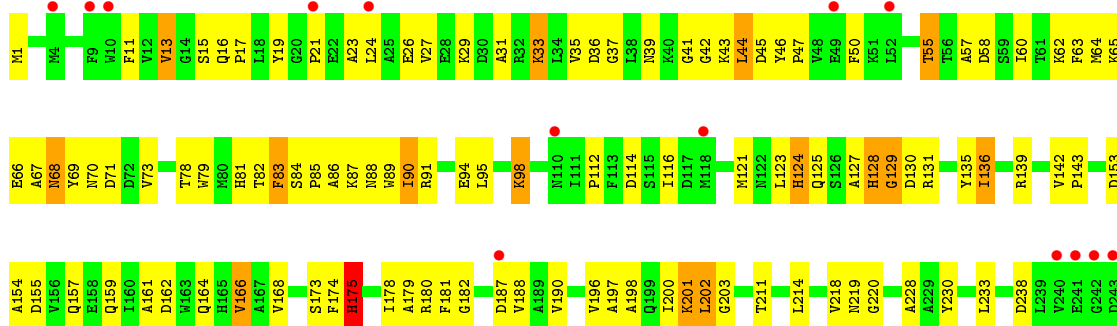

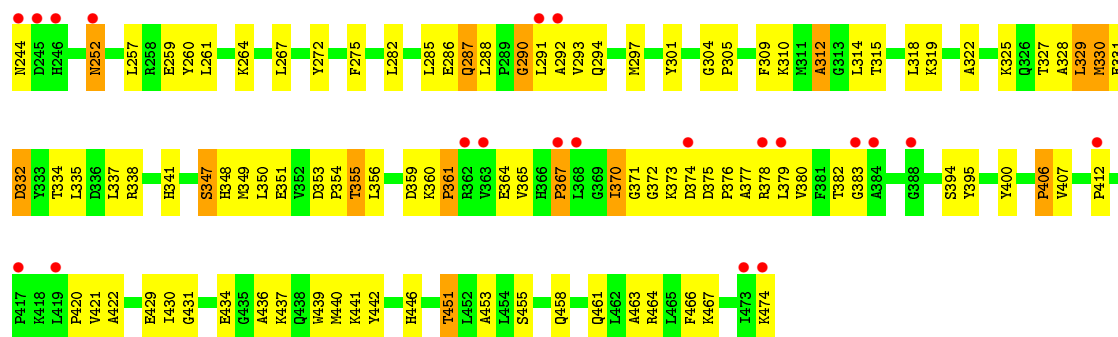

4 Data and refinement statistics

Property	Value	Source
Space group	P 21 21 21	Depositor
Cell constants a, b, c, α , β , γ	85.20Å 184.83Å 186.35Å 90.00° 90.00° 90.00°	Depositor
Resolution (Å)	44.85 – 3.23 44.85 – 3.23	Depositor EDS
% Data completeness (in resolution range)	99.1 (44.85-3.23) 99.1 (44.85-3.23)	Depositor EDS
R_{merge}	0.10	Depositor
R_{sym}	(Not available)	Depositor
$\langle I/\sigma(I) \rangle$ ¹	2.54 (at 3.25Å)	Xtrriage
Refinement program	PHENIX (phenix.refine: 1.8_1069)	Depositor
R, R_{free}	0.314 , 0.432 0.315 , 0.434	Depositor DCC
R_{free} test set	2404 reflections (5.06%)	wwPDB-VP
Wilson B-factor (Å ²)	94.8	Xtrriage
Anisotropy	0.073	Xtrriage
Bulk solvent k_{sol} (e/Å ³), B_{sol} (Å ²)	0.23 , 132.1	EDS
L-test for twinning ²	$\langle L \rangle = 0.49$, $\langle L^2 \rangle = 0.32$	Xtrriage
Estimated twinning fraction	0.010 for -h,l,k	Xtrriage
F_o, F_c correlation	0.84	EDS
Total number of atoms	18516	wwPDB-VP
Average B, all atoms (Å ²)	80.0	wwPDB-VP

Xtrriage's analysis on translational NCS is as follows: *The largest off-origin peak in the Patterson function is 2.86% of the height of the origin peak. No significant pseudotranslation is detected.*

¹Intensities estimated from amplitudes.

²Theoretical values of $\langle |L| \rangle$, $\langle L^2 \rangle$ for acentric reflections are 0.5, 0.333 respectively for untwinned datasets, and 0.375, 0.2 for perfectly twinned datasets.

5 Model quality i

5.1 Standard geometry i

The Z score for a bond length (or angle) is the number of standard deviations the observed value is removed from the expected value. A bond length (or angle) with $|Z| > 5$ is considered an outlier worth inspection. RMSZ is the root-mean-square of all Z scores of the bond lengths (or angles).

Mol	Chain	Bond lengths		Bond angles	
		RMSZ	# Z >5	RMSZ	# Z >5
1	A	0.53	0/3156	0.80	1/4270 (0.0%)
1	B	0.58	0/3176	0.83	1/4293 (0.0%)
1	C	0.47	0/3060	0.72	0/4151
1	D	0.47	0/3156	0.72	0/4270
1	E	0.47	0/3176	0.70	1/4293 (0.0%)
1	F	0.50	0/3060	0.75	3/4151 (0.1%)
All	All	0.51	0/18784	0.76	6/25428 (0.0%)

Chiral center outliers are detected by calculating the chiral volume of a chiral center and verifying if the center is modelled as a planar moiety or with the opposite hand. A planarity outlier is detected by checking planarity of atoms in a peptide group, atoms in a mainchain group or atoms of a sidechain that are expected to be planar.

Mol	Chain	#Chirality outliers	#Planarity outliers
1	A	0	1

There are no bond length outliers.

The worst 5 of 6 bond angle outliers are listed below:

Mol	Chain	Res	Type	Atoms	Z	Observed(°)	Ideal(°)
1	A	95	LEU	CA-CB-CG	6.87	131.09	115.30
1	F	95	LEU	CA-CB-CG	6.21	129.58	115.30
1	E	282	LEU	CA-CB-CG	5.97	129.04	115.30
1	B	404	GLY	N-CA-C	5.68	127.31	113.10
1	F	202	LEU	CA-CB-CG	5.24	127.35	115.30

There are no chirality outliers.

All (1) planarity outliers are listed below:

Mol	Chain	Res	Type	Group
1	A	143	PRO	Peptide

5.2 Too-close contacts [i](#)

In the following table, the Non-H and H(model) columns list the number of non-hydrogen atoms and hydrogen atoms in the chain respectively. The H(added) column lists the number of hydrogen atoms added and optimized by MolProbity. The Clashes column lists the number of clashes within the asymmetric unit, whereas Symm-Clashes lists symmetry related clashes.

Mol	Chain	Non-H	H(model)	H(added)	Clashes	Symm-Clashes
1	A	3111	0	2557	132	0
1	B	3130	0	2581	141	0
1	C	3017	0	2377	123	0
1	D	3111	0	2557	116	0
1	E	3130	0	2581	155	0
1	F	3017	0	2377	148	0
All	All	18516	0	15030	752	0

The all-atom clashscore is defined as the number of clashes found per 1000 atoms (including hydrogen atoms). The all-atom clashscore for this structure is 22.

The worst 5 of 752 close contacts within the same asymmetric unit are listed below, sorted by their clash magnitude.

Atom-1	Atom-2	Interatomic distance (Å)	Clash overlap (Å)
1:C:294:GLN:HE21	1:C:352:VAL:H	1.20	0.89
1:A:439:TRP:NE1	1:A:444:GLY:O	2.07	0.88
1:A:308:ASP:OD2	1:A:447:HIS:ND1	2.07	0.87
1:A:85:PRO:HB3	1:C:188:VAL:HG22	1.58	0.86
1:A:192:GLU:O	1:A:310:LYS:NZ	2.09	0.85

There are no symmetry-related clashes.

5.3 Torsion angles [i](#)

5.3.1 Protein backbone [i](#)

In the following table, the Percentiles column shows the percent Ramachandran outliers of the chain as a percentile score with respect to all X-ray entries followed by that with respect to entries of similar resolution.

The Analysed column shows the number of residues for which the backbone conformation was analysed, and the total number of residues.

Mol	Chain	Analysed	Favoured	Allowed	Outliers	Percentiles
1	A	472/474 (100%)	336 (71%)	89 (19%)	47 (10%)	0 3

Continued on next page...

Continued from previous page...

Mol	Chain	Analysed	Favoured	Allowed	Outliers	Percentiles	
1	B	472/474 (100%)	345 (73%)	86 (18%)	41 (9%)	1	4
1	C	472/474 (100%)	360 (76%)	80 (17%)	32 (7%)	1	7
1	D	472/474 (100%)	348 (74%)	84 (18%)	40 (8%)	1	4
1	E	472/474 (100%)	325 (69%)	108 (23%)	39 (8%)	1	4
1	F	472/474 (100%)	323 (68%)	107 (23%)	42 (9%)	1	4
All	All	2832/2844 (100%)	2037 (72%)	554 (20%)	241 (8%)	1	4

5 of 241 Ramachandran outliers are listed below:

Mol	Chain	Res	Type
1	A	63	PHE
1	A	305	PRO
1	A	306	GLU
1	A	356	LEU
1	A	367	PRO

5.3.2 Protein sidechains [i](#)

In the following table, the Percentiles column shows the percent sidechain outliers of the chain as a percentile score with respect to all X-ray entries followed by that with respect to entries of similar resolution.

The Analysed column shows the number of residues for which the sidechain conformation was analysed, and the total number of residues.

Mol	Chain	Analysed	Rotameric	Outliers	Percentiles	
1	A	194/393 (49%)	161 (83%)	33 (17%)	2	9
1	B	199/393 (51%)	161 (81%)	38 (19%)	1	7
1	C	173/393 (44%)	140 (81%)	33 (19%)	1	7
1	D	194/393 (49%)	157 (81%)	37 (19%)	1	7
1	E	199/393 (51%)	150 (75%)	49 (25%)	0	2
1	F	173/393 (44%)	142 (82%)	31 (18%)	2	8
All	All	1132/2358 (48%)	911 (80%)	221 (20%)	1	6

5 of 221 residues with a non-rotameric sidechain are listed below:

Mol	Chain	Res	Type
1	C	421	VAL

Continued on next page...

Continued from previous page...

Mol	Chain	Res	Type
1	D	315	THR
1	F	175	HIS
1	C	451	THR
1	D	101	LEU

Some sidechains can be flipped to improve hydrogen bonding and reduce clashes. 5 of 11 such sidechains are listed below:

Mol	Chain	Res	Type
1	C	106	GLN
1	D	125	GLN
1	F	252	ASN
1	B	461	GLN
1	F	81	HIS

5.3.3 RNA [i](#)

There are no RNA molecules in this entry.

5.4 Non-standard residues in protein, DNA, RNA chains [i](#)

There are no non-standard protein/DNA/RNA residues in this entry.

5.5 Carbohydrates [i](#)

There are no carbohydrates in this entry.

5.6 Ligand geometry [i](#)

There are no ligands in this entry.

5.7 Other polymers [i](#)

There are no such residues in this entry.

5.8 Polymer linkage issues [i](#)

There are no chain breaks in this entry.

6 Fit of model and data [i](#)

6.1 Protein, DNA and RNA chains [i](#)

In the following table, the column labelled ‘#RSRZ> 2’ contains the number (and percentage) of RSRZ outliers, followed by percent RSRZ outliers for the chain as percentile scores relative to all X-ray entries and entries of similar resolution. The OWAB column contains the minimum, median, 95th percentile and maximum values of the occupancy-weighted average B-factor per residue. The column labelled ‘Q< 0.9’ lists the number of (and percentage) of residues with an average occupancy less than 0.9.

Mol	Chain	Analysed	<RSRZ>	#RSRZ>2	OWAB(Å ²)	Q<0.9
1	A	474/474 (100%)	0.20	39 (8%) 11 8	29, 72, 143, 172	0
1	B	474/474 (100%)	-0.01	18 (3%) 40 29	27, 57, 115, 221	0
1	C	474/474 (100%)	0.21	25 (5%) 26 17	35, 81, 134, 191	0
1	D	474/474 (100%)	0.34	38 (8%) 12 8	32, 83, 148, 204	0
1	E	474/474 (100%)	0.35	38 (8%) 12 8	33, 89, 151, 246	0
1	F	474/474 (100%)	0.27	35 (7%) 14 10	35, 78, 135, 165	0
All	All	2844/2844 (100%)	0.23	193 (6%) 17 12	27, 77, 140, 246	0

The worst 5 of 193 RSRZ outliers are listed below:

Mol	Chain	Res	Type	RSRZ
1	B	324	ASN	18.3
1	D	244	ASN	11.2
1	E	245	ASP	10.7
1	E	412	PRO	10.6
1	E	474	LYS	9.6

6.2 Non-standard residues in protein, DNA, RNA chains [i](#)

There are no non-standard protein/DNA/RNA residues in this entry.

6.3 Carbohydrates [i](#)

There are no carbohydrates in this entry.

6.4 Ligands [i](#)

There are no ligands in this entry.

6.5 Other polymers

There are no such residues in this entry.