



# Full wwPDB X-ray Structure Validation Report ⓘ

Dec 12, 2023 – 07:11 pm GMT

PDB ID : 4ARY  
Title : Lepidopteran-specific toxin Cry1Ac in complex with receptor specificity determinant GalNAc  
Authors : Derbyshire, D.J.; Carroll, J.; Ellar, D.J.; Li, J.  
Deposited on : 2012-04-27  
Resolution : 2.95 Å(reported)

This is a Full wwPDB X-ray Structure Validation Report for a publicly released PDB entry.

We welcome your comments at [validation@mail.wwpdb.org](mailto:validation@mail.wwpdb.org)

A user guide is available at

<https://www.wwpdb.org/validation/2017/XrayValidationReportHelp>

with specific help available everywhere you see the ⓘ symbol.

The types of validation reports are described at

<http://www.wwpdb.org/validation/2017/FAQs#types>.

---

The following versions of software and data (see [references ⓘ](#)) were used in the production of this report:

MolProbity : 4.02b-467  
Mogul : 1.8.4, CSD as541be (2020)  
Xtriage (Phenix) : 1.13  
EDS : 2.36  
Percentile statistics : 20191225.v01 (using entries in the PDB archive December 25th 2019)  
Refmac : 5.8.0158  
CCP4 : 7.0.044 (Gargrove)  
Ideal geometry (proteins) : Engh & Huber (2001)  
Ideal geometry (DNA, RNA) : Parkinson et al. (1996)  
Validation Pipeline (wwPDB-VP) : 2.36

# 1 Overall quality at a glance

The following experimental techniques were used to determine the structure:

*X-RAY DIFFRACTION*

The reported resolution of this entry is 2.95 Å.

Percentile scores (ranging between 0-100) for global validation metrics of the entry are shown in the following graphic. The table shows the number of entries on which the scores are based.

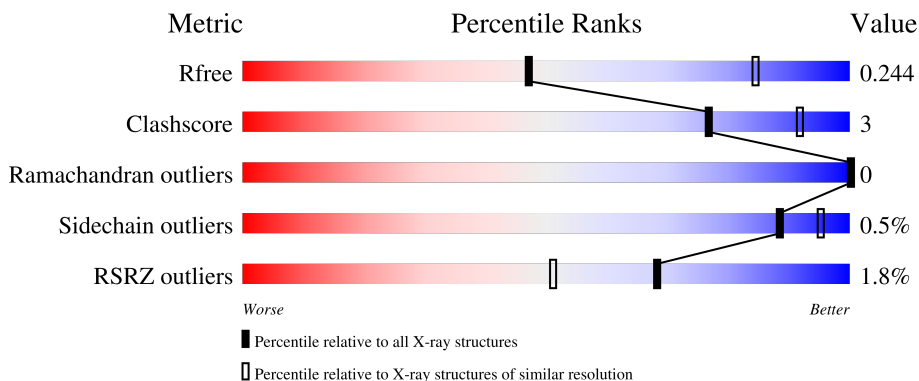

Metric	Whole archive (#Entries)	Similar resolution (#Entries, resolution range(Å))
$R_{free}$	130704	3104 (3.00-2.92)
Clashscore	141614	3462 (3.00-2.92)
Ramachandran outliers	138981	3340 (3.00-2.92)
Sidechain outliers	138945	3343 (3.00-2.92)
RSRZ outliers	127900	2986 (3.00-2.92)

The table below summarises the geometric issues observed across the polymeric chains and their fit to the electron density. The red, orange, yellow and green segments of the lower bar indicate the fraction of residues that contain outliers for  $\geq 3$ , 2, 1 and 0 types of geometric quality criteria respectively. A grey segment represents the fraction of residues that are not modelled. The numeric value for each fraction is indicated below the corresponding segment, with a dot representing fractions  $\leq 5\%$ . The upper red bar (where present) indicates the fraction of residues that have poor fit to the electron density. The numeric value is given above the bar.

Mol	Chain	Length	Quality of chain
1	A	581	 93% 7%
1	B	581	 93% 6%
1	C	581	 92% 7% .
1	D	581	 93% 7% .

## 2 Entry composition [i](#)

There are 4 unique types of molecules in this entry. The entry contains 18492 atoms, of which 0 are hydrogens and 0 are deuteriums.

In the tables below, the ZeroOcc column contains the number of atoms modelled with zero occupancy, the AltConf column contains the number of residues with at least one atom in alternate conformation and the Trace column contains the number of residues modelled with at most 2 atoms.

- Molecule 1 is a protein called PESTICIDAL CRYSTAL PROTEIN CRY1AC.

Mol	Chain	Residues	Atoms					ZeroOcc	AltConf	Trace
			Total	C	N	O	S			
1	A	579	Total	C	N	O	S	0	0	1
			4594	2924	804	859	7			
1	B	580	Total	C	N	O	S	0	0	0
			4606	2931	805	863	7			
1	C	578	Total	C	N	O	S	0	0	1
			4587	2920	803	857	7			
1	D	578	Total	C	N	O	S	0	0	1
			4587	2920	803	857	7			

- Molecule 2 is 2-acetamido-2-deoxy-beta-D-galactopyranose (three-letter code: NGA) (formula: C<sub>8</sub>H<sub>15</sub>NO<sub>6</sub>).

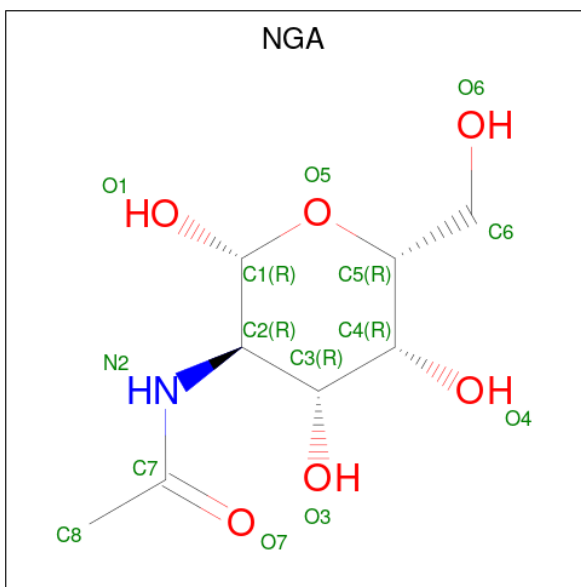

Mol	Chain	Residues	Atoms				ZeroOcc	AltConf
			Total	C	N	O		
2	A	1	Total	C	N	O	0	0
			15	8	1	6		
2	B	1	Total	C	N	O	0	0
			15	8	1	6		

*Continued on next page...*

Continued from previous page...

Mol	Chain	Residues	Atoms				ZeroOcc	AltConf
2	C	1	Total	C	N	O	0	0
			15	8	1	6		
2	D	1	Total	C	N	O	0	0
			15	8	1	6		

- Molecule 3 is 1,3-DIAMINOPROPANE (three-letter code: 13D) (formula: C<sub>3</sub>H<sub>10</sub>N<sub>2</sub>).

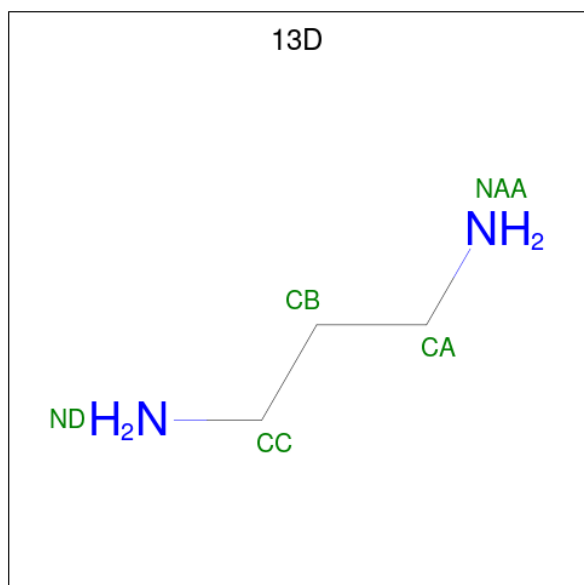

Mol	Chain	Residues	Atoms			ZeroOcc	AltConf
3	A	1	Total	C	N	0	0
			5	3	2		
3	B	1	Total	C	N	0	0
			5	3	2		

- Molecule 4 is water.

Mol	Chain	Residues	Atoms		ZeroOcc	AltConf
4	A	20	Total	O	0	0
			20	20		
4	B	10	Total	O	0	0
			10	10		
4	C	9	Total	O	0	0
			9	9		
4	D	9	Total	O	0	0
			9	9		

### 3 Residue-property plots [i](#)

These plots are drawn for all protein, RNA, DNA and oligosaccharide chains in the entry. The first graphic for a chain summarises the proportions of the various outlier classes displayed in the second graphic. The second graphic shows the sequence view annotated by issues in geometry and electron density. Residues are color-coded according to the number of geometric quality criteria for which they contain at least one outlier: green = 0, yellow = 1, orange = 2 and red = 3 or more. A red dot above a residue indicates a poor fit to the electron density ( $RSRZ > 2$ ). Stretches of 2 or more consecutive residues without any outlier are shown as a green connector. Residues present in the sample, but not in the model, are shown in grey.

- Molecule 1: PESTICIDAL CRYSTAL PROTEIN CRY1AC

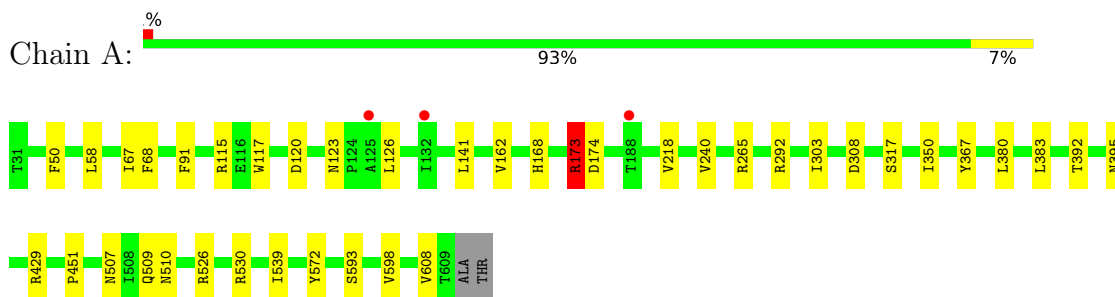

- Molecule 1: PESTICIDAL CRYSTAL PROTEIN CRY1AC

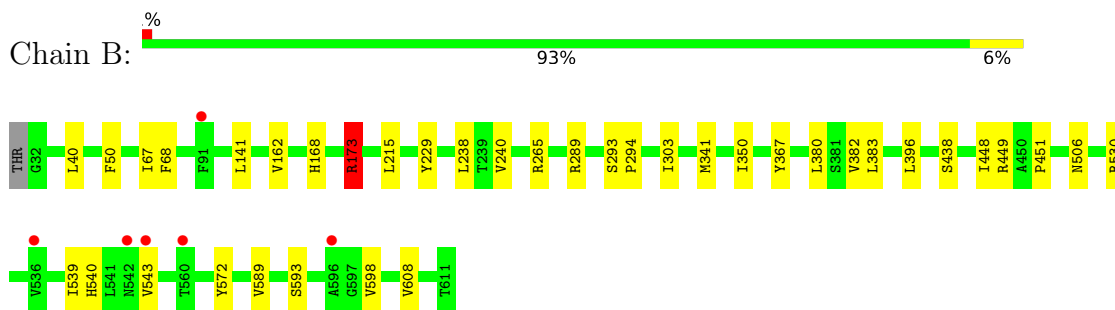

- Molecule 1: PESTICIDAL CRYSTAL PROTEIN CRY1AC

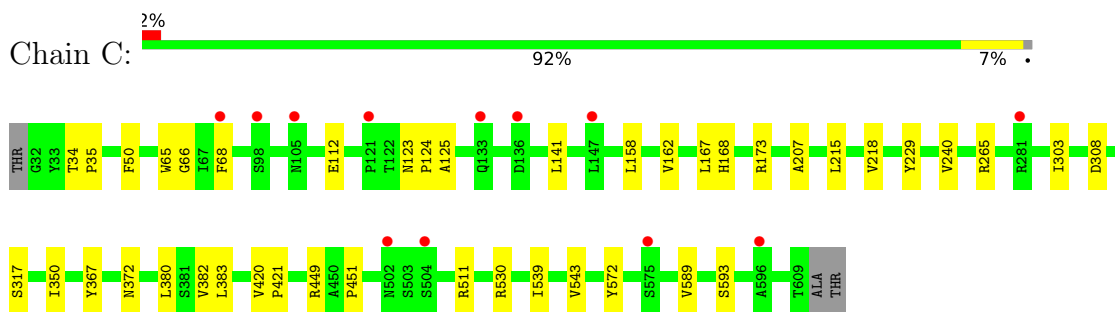

- Molecule 1: PESTICIDAL CRYSTAL PROTEIN CRY1AC

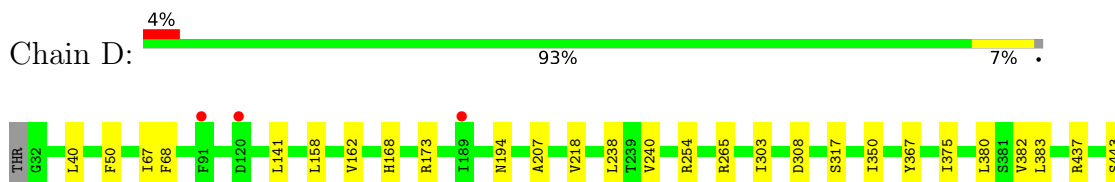

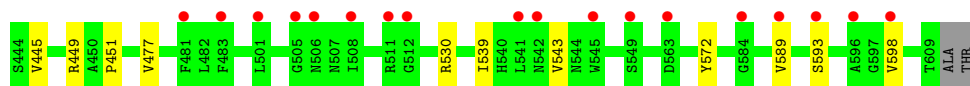

## 4 Data and refinement statistics

Property	Value	Source
Space group	P 1 21 1	Depositor
Cell constants a, b, c, $\alpha$ , $\beta$ , $\gamma$	121.36Å 51.19Å 210.65Å 90.00° 105.75° 90.00°	Depositor
Resolution (Å)	223.61 – 2.95 46.89 – 2.95	Depositor EDS
% Data completeness (in resolution range)	87.1 (223.61-2.95) 87.2 (46.89-2.95)	Depositor EDS
$R_{merge}$	0.14	Depositor
$R_{sym}$	(Not available)	Depositor
$\langle I/\sigma(I) \rangle$ <sup>1</sup>	2.23 (at 2.96Å)	Xtrriage
Refinement program	REFMAC 5.7.0002	Depositor
R, $R_{free}$	0.215 , 0.244 0.216 , 0.244	Depositor DCC
$R_{free}$ test set	2354 reflections (5.04%)	wwPDB-VP
Wilson B-factor (Å <sup>2</sup> )	49.0	Xtrriage
Anisotropy	1.117	Xtrriage
Bulk solvent $k_{sol}$ (e/Å <sup>3</sup> ), $B_{sol}$ (Å <sup>2</sup> )	0.33 , 46.9	EDS
L-test for twinning <sup>2</sup>	$\langle  L  \rangle = 0.47$ , $\langle L^2 \rangle = 0.30$	Xtrriage
Estimated twinning fraction	0.042 for h,-k,-h-l	Xtrriage
$F_o, F_c$ correlation	0.92	EDS
Total number of atoms	18492	wwPDB-VP
Average B, all atoms (Å <sup>2</sup> )	48.0	wwPDB-VP

Xtrriage's analysis on translational NCS is as follows: *The largest off-origin peak in the Patterson function is 8.57% of the height of the origin peak. No significant pseudotranslation is detected.*

<sup>1</sup>Intensities estimated from amplitudes.

<sup>2</sup>Theoretical values of  $\langle |L| \rangle$ ,  $\langle L^2 \rangle$  for acentric reflections are 0.5, 0.333 respectively for untwinned datasets, and 0.375, 0.2 for perfectly twinned datasets.

## 5 Model quality [i](#)

### 5.1 Standard geometry [i](#)

Bond lengths and bond angles in the following residue types are not validated in this section: 13D, NGA

The Z score for a bond length (or angle) is the number of standard deviations the observed value is removed from the expected value. A bond length (or angle) with  $|Z| > 5$  is considered an outlier worth inspection. RMSZ is the root-mean-square of all Z scores of the bond lengths (or angles).

Mol	Chain	Bond lengths		Bond angles	
		RMSZ	# Z  >5	RMSZ	# Z  >5
1	A	0.67	0/4714	0.70	1/6425 (0.0%)
1	B	0.64	0/4726	0.69	2/6440 (0.0%)
1	C	0.65	0/4707	0.69	0/6415
1	D	0.65	0/4707	0.69	0/6415
All	All	0.65	0/18854	0.69	3/25695 (0.0%)

Chiral center outliers are detected by calculating the chiral volume of a chiral center and verifying if the center is modelled as a planar moiety or with the opposite hand. A planarity outlier is detected by checking planarity of atoms in a peptide group, atoms in a mainchain group or atoms of a sidechain that are expected to be planar.

Mol	Chain	#Chirality outliers	#Planarity outliers
1	A	0	1
1	B	0	1
1	D	0	1
All	All	0	3

There are no bond length outliers.

All (3) bond angle outliers are listed below:

Mol	Chain	Res	Type	Atoms	Z	Observed(°)	Ideal(°)
1	B	173	ARG	NE-CZ-NH2	-5.20	117.70	120.30
1	B	396	LEU	CA-CB-CG	5.10	127.02	115.30
1	A	292	ARG	NE-CZ-NH2	-5.06	117.77	120.30

There are no chirality outliers.

All (3) planarity outliers are listed below:



Mol	Chain	Res	Type	Group
1	A	173	ARG	Sidechain
1	B	173	ARG	Sidechain
1	D	173	ARG	Sidechain

## 5.2 Too-close contacts [i](#)

In the following table, the Non-H and H(model) columns list the number of non-hydrogen atoms and hydrogen atoms in the chain respectively. The H(added) column lists the number of hydrogen atoms added and optimized by MolProbity. The Clashes column lists the number of clashes within the asymmetric unit, whereas Symm-Clashes lists symmetry-related clashes.

Mol	Chain	Non-H	H(model)	H(added)	Clashes	Symm-Clashes
1	A	4594	0	4448	25	0
1	B	4606	0	4460	24	0
1	C	4587	0	4441	42	0
1	D	4587	0	4441	38	0
2	A	15	0	15	0	0
2	B	15	0	15	0	0
2	C	15	0	15	1	0
2	D	15	0	15	0	0
3	A	5	0	10	0	0
3	B	5	0	10	0	0
4	A	20	0	0	1	0
4	B	10	0	0	0	0
4	C	9	0	0	0	0
4	D	9	0	0	1	0
All	All	18492	0	17870	107	0

The all-atom clashscore is defined as the number of clashes found per 1000 atoms (including hydrogen atoms). The all-atom clashscore for this structure is 3.

All (107) close contacts within the same asymmetric unit are listed below, sorted by their clash magnitude.

Atom-1	Atom-2	Interatomic distance (Å)	Clash overlap (Å)
1:C:68:PHE:HB2	1:D:443:SER:O	1.54	1.04
1:C:68:PHE:CD2	1:D:375:ILE:CG1	2.51	0.93
1:C:68:PHE:CZ	1:D:445:VAL:HG13	2.06	0.90
1:C:68:PHE:CD2	1:D:375:ILE:HG13	2.10	0.87
1:C:112:GLU:HG2	1:D:437:ARG:NH2	1.89	0.86
1:C:68:PHE:HD2	1:D:375:ILE:CG1	1.89	0.86
1:C:162:VAL:HG21	1:C:240:VAL:HG13	1.58	0.85

*Continued on next page...*

*Continued from previous page...*

Atom-1	Atom-2	Interatomic distance (Å)	Clash overlap (Å)
1:C:68:PHE:HD2	1:D:375:ILE:HD11	1.42	0.84
1:C:68:PHE:HD2	1:D:375:ILE:CD1	1.90	0.83
1:A:162:VAL:HG21	1:A:240:VAL:HG13	1.65	0.79
1:D:162:VAL:HG21	1:D:240:VAL:HG13	1.67	0.76
1:C:112:GLU:HG2	1:D:437:ARG:HH22	1.49	0.76
1:B:506:ASN:HB2	1:D:254:ARG:NH2	2.02	0.74
1:C:68:PHE:CD2	1:D:375:ILE:HD11	2.26	0.70
1:D:530:ARG:HD3	1:D:572:TYR:CD2	2.28	0.69
1:A:530:ARG:HD3	1:A:572:TYR:CD2	2.29	0.68
1:C:530:ARG:HD3	1:C:572:TYR:CD2	2.28	0.68
1:B:162:VAL:HG21	1:B:240:VAL:HG13	1.73	0.68
1:C:68:PHE:HB2	1:D:443:SER:C	2.14	0.68
1:C:123:ASN:C	1:C:123:ASN:OD1	2.32	0.67
1:C:65:TRP:NE1	1:C:167:LEU:HD13	2.09	0.67
1:B:530:ARG:HD3	1:B:572:TYR:CD2	2.30	0.67
1:C:123:ASN:OD1	1:C:125:ALA:N	2.27	0.67
1:B:173:ARG:HH11	1:B:173:ARG:HB3	1.63	0.63
1:C:65:TRP:CE2	1:C:167:LEU:HD22	2.36	0.61
1:A:429:ARG:HD3	4:A:2011:HOH:O	2.02	0.59
1:C:123:ASN:OD1	1:C:124:PRO:N	2.36	0.58
1:C:65:TRP:CZ2	1:C:167:LEU:HD22	2.37	0.58
1:C:68:PHE:CZ	1:D:445:VAL:CG1	2.83	0.58
1:D:383:LEU:HD12	1:D:451:PRO:HG2	1.86	0.57
1:A:507:ASN:HB3	1:A:510:ASN:HB3	1.87	0.56
1:C:68:PHE:CD2	1:D:375:ILE:HG12	2.40	0.56
1:D:303:ILE:HG23	1:D:350:ILE:HB	1.88	0.55
1:B:303:ILE:HG23	1:B:350:ILE:HB	1.90	0.54
1:D:141:LEU:HD13	1:D:168:HIS:HA	1.90	0.53
1:B:383:LEU:HD12	1:B:451:PRO:HG2	1.89	0.53
1:A:141:LEU:HD13	1:A:168:HIS:HA	1.90	0.52
1:D:40:LEU:HD21	1:D:238:LEU:HD22	1.92	0.52
1:A:58:LEU:HD11	1:A:115:ARG:HD2	1.92	0.52
1:C:303:ILE:HG23	1:C:350:ILE:HB	1.92	0.52
1:A:383:LEU:HD12	1:A:451:PRO:HG2	1.92	0.51
1:B:141:LEU:HD13	1:B:168:HIS:HA	1.92	0.51
1:C:511:ARG:HB2	2:C:1609:NGA:O3	2.10	0.51
1:D:218:VAL:HG12	1:D:218:VAL:O	2.11	0.51
1:C:112:GLU:HG2	1:D:437:ARG:CZ	2.41	0.50
1:D:67:ILE:HG12	1:D:68:PHE:N	2.25	0.50
1:C:372:ASN:O	1:C:372:ASN:OD1	2.30	0.50
1:C:383:LEU:HD12	1:C:451:PRO:HG2	1.94	0.50

*Continued on next page...*

*Continued from previous page...*

Atom-1	Atom-2	Interatomic distance (Å)	Clash overlap (Å)
1:B:506:ASN:HB2	1:D:254:ARG:HH22	1.72	0.50
1:C:141:LEU:HD13	1:C:168:HIS:HA	1.93	0.49
1:B:530:ARG:HD3	1:B:572:TYR:HD2	1.76	0.49
1:A:530:ARG:HD3	1:A:572:TYR:HD2	1.76	0.49
1:A:539:ILE:HD13	1:A:598:VAL:HB	1.94	0.49
1:C:530:ARG:HD3	1:C:572:TYR:HD2	1.75	0.49
1:B:608:VAL:O	1:B:608:VAL:HG23	2.13	0.49
1:B:540:HIS:HB2	1:D:194:ASN:ND2	2.28	0.49
1:A:303:ILE:HG23	1:A:350:ILE:HB	1.95	0.48
1:C:34:THR:HB	1:C:35:PRO:HD2	1.95	0.48
1:A:367:TYR:HA	1:A:380:LEU:O	2.14	0.47
1:C:68:PHE:HB3	1:D:375:ILE:HG12	1.95	0.47
1:A:539:ILE:HG13	1:A:593:SER:HB2	1.96	0.47
1:B:367:TYR:HA	1:B:380:LEU:O	2.15	0.46
1:A:117:TRP:HA	1:A:126:LEU:HD13	1.97	0.46
1:D:367:TYR:HA	1:D:380:LEU:O	2.16	0.46
1:A:120:ASP:HB3	1:A:126:LEU:CD1	2.45	0.46
1:B:67:ILE:HG12	1:B:68:PHE:N	2.31	0.46
1:A:526:ARG:HB2	1:A:608:VAL:HG22	1.98	0.46
1:A:91:PHE:CE1	1:B:341:MET:CE	3.00	0.45
1:B:539:ILE:HD13	1:B:598:VAL:HB	1.98	0.45
1:C:66:GLY:O	1:D:443:SER:HB3	2.17	0.45
1:A:123:ASN:HB3	1:A:126:LEU:HD12	1.99	0.44
1:A:509:GLN:OE1	1:A:509:GLN:HA	2.17	0.44
1:D:530:ARG:HD3	1:D:572:TYR:HD2	1.75	0.44
1:A:173:ARG:NH1	1:A:174:ASP:OD1	2.51	0.44
1:B:539:ILE:HG13	1:B:593:SER:HB2	2.00	0.44
1:C:367:TYR:HA	1:C:380:LEU:O	2.18	0.44
1:D:308:ASP:HB2	1:D:317:SER:HB3	1.99	0.44
1:B:382:VAL:HG12	1:B:449:ARG:HB2	1.99	0.43
1:B:543:VAL:HG22	1:B:589:VAL:HG22	2.00	0.43
1:C:543:VAL:HG22	1:C:589:VAL:HG22	2.00	0.43
1:D:382:VAL:HG12	1:D:449:ARG:HB2	2.00	0.43
1:C:218:VAL:HG12	1:C:218:VAL:O	2.18	0.43
1:C:308:ASP:HB2	1:C:317:SER:HB3	2.00	0.43
1:A:218:VAL:O	1:A:218:VAL:HG12	2.19	0.43
1:A:392:THR:HG21	1:A:395:ASN:HA	2.00	0.42
1:C:382:VAL:HG12	1:C:449:ARG:HB2	2.01	0.42
1:A:67:ILE:HG12	1:A:68:PHE:N	2.35	0.42
1:B:215:LEU:HG	1:B:229:TYR:CE1	2.54	0.42
1:D:543:VAL:HG22	1:D:589:VAL:HG22	2.00	0.42

*Continued on next page...*

Continued from previous page...

Atom-1	Atom-2	Interatomic distance (Å)	Clash overlap (Å)
1:A:91:PHE:HE1	1:B:341:MET:HE3	1.85	0.42
1:B:289:ARG:HD3	1:B:289:ARG:HA	1.87	0.42
1:C:215:LEU:HG	1:C:229:TYR:CE1	2.55	0.41
1:D:218:VAL:O	1:D:218:VAL:CG1	2.68	0.41
1:D:158:LEU:HD11	1:D:207:ALA:HA	2.02	0.41
1:C:68:PHE:CB	1:D:443:SER:O	2.44	0.41
1:D:539:ILE:HG13	1:D:593:SER:HB2	2.02	0.41
1:C:65:TRP:HE1	1:C:167:LEU:HD13	1.82	0.41
1:D:539:ILE:HD13	1:D:598:VAL:HB	2.03	0.41
1:A:526:ARG:HB2	1:A:608:VAL:CG2	2.50	0.41
1:D:477:VAL:HG13	4:D:2008:HOH:O	2.21	0.41
1:C:539:ILE:HG13	1:C:593:SER:HB2	2.04	0.40
1:B:293:SER:HB2	1:B:294:PRO:HD2	2.03	0.40
1:B:40:LEU:HD21	1:B:238:LEU:HD22	2.03	0.40
1:C:158:LEU:HD11	1:C:207:ALA:HA	2.04	0.40
1:A:308:ASP:HB2	1:A:317:SER:HB3	2.03	0.40
1:B:438:SER:HB3	1:B:448:ILE:HB	2.04	0.40
1:C:420:VAL:HB	1:C:421:PRO:HD2	2.04	0.40

There are no symmetry-related clashes.

## 5.3 Torsion angles

### 5.3.1 Protein backbone

In the following table, the Percentiles column shows the percent Ramachandran outliers of the chain as a percentile score with respect to all X-ray entries followed by that with respect to entries of similar resolution.

The Analysed column shows the number of residues for which the backbone conformation was analysed, and the total number of residues.

Mol	Chain	Analysed	Favoured	Allowed	Outliers	Percentiles	
1	A	577/581 (99%)	566 (98%)	11 (2%)	0	100	100
1	B	578/581 (100%)	565 (98%)	13 (2%)	0	100	100
1	C	576/581 (99%)	566 (98%)	10 (2%)	0	100	100
1	D	576/581 (99%)	564 (98%)	12 (2%)	0	100	100
All	All	2307/2324 (99%)	2261 (98%)	46 (2%)	0	100	100

There are no Ramachandran outliers to report.

### 5.3.2 Protein sidechains [i](#)

In the following table, the Percentiles column shows the percent sidechain outliers of the chain as a percentile score with respect to all X-ray entries followed by that with respect to entries of similar resolution.

The Analysed column shows the number of residues for which the sidechain conformation was analysed, and the total number of residues.

Mol	Chain	Analysed	Rotameric	Outliers	Percentiles	
1	A	501/503 (100%)	498 (99%)	3 (1%)	86	94
1	B	502/503 (100%)	499 (99%)	3 (1%)	86	94
1	C	500/503 (99%)	497 (99%)	3 (1%)	86	94
1	D	500/503 (99%)	498 (100%)	2 (0%)	91	96
All	All	2003/2012 (100%)	1992 (100%)	11 (0%)	88	95

All (11) residues with a non-rotameric sidechain are listed below:

Mol	Chain	Res	Type
1	A	50	PHE
1	A	173	ARG
1	A	265	ARG
1	B	50	PHE
1	B	173	ARG
1	B	265	ARG
1	C	50	PHE
1	C	173	ARG
1	C	265	ARG
1	D	50	PHE
1	D	265	ARG

Sometimes sidechains can be flipped to improve hydrogen bonding and reduce clashes. There are no such sidechains identified.

### 5.3.3 RNA [i](#)

There are no RNA molecules in this entry.

## 5.4 Non-standard residues in protein, DNA, RNA chains [i](#)

There are no non-standard protein/DNA/RNA residues in this entry.

## 5.5 Carbohydrates [i](#)

There are no monosaccharides in this entry.

## 5.6 Ligand geometry [i](#)

6 ligands are modelled in this entry.

In the following table, the Counts columns list the number of bonds (or angles) for which Mogul statistics could be retrieved, the number of bonds (or angles) that are observed in the model and the number of bonds (or angles) that are defined in the Chemical Component Dictionary. The Link column lists molecule types, if any, to which the group is linked. The Z score for a bond length (or angle) is the number of standard deviations the observed value is removed from the expected value. A bond length (or angle) with  $|Z| > 2$  is considered an outlier worth inspection. RMSZ is the root-mean-square of all Z scores of the bond lengths (or angles).

Mol	Type	Chain	Res	Link	Bond lengths			Bond angles		
					Counts	RMSZ	# Z  > 2	Counts	RMSZ	# Z  > 2
3	13D	B	1613	-	4,4,4	0.11	0	3,3,3	0.42	0
2	NGA	B	1612	-	15,15,15	0.39	0	21,21,21	0.44	0
2	NGA	D	1609	-	15,15,15	0.42	0	21,21,21	0.48	0
2	NGA	C	1609	-	15,15,15	0.33	0	21,21,21	0.92	0
2	NGA	A	1609	-	15,15,15	0.47	0	21,21,21	0.58	0
3	13D	A	1610	-	4,4,4	0.17	0	3,3,3	0.43	0

In the following table, the Chirals column lists the number of chiral outliers, the number of chiral centers analysed, the number of these observed in the model and the number defined in the Chemical Component Dictionary. Similar counts are reported in the Torsion and Rings columns. '-' means no outliers of that kind were identified.

Mol	Type	Chain	Res	Link	Chirals	Torsions	Rings
3	13D	B	1613	-	-	0/2/2/2	-
2	NGA	B	1612	-	-	0/6/26/26	0/1/1/1
2	NGA	D	1609	-	-	2/6/26/26	0/1/1/1
2	NGA	C	1609	-	-	2/6/26/26	0/1/1/1
2	NGA	A	1609	-	-	0/6/26/26	0/1/1/1
3	13D	A	1610	-	-	0/2/2/2	-

There are no bond length outliers.

There are no bond angle outliers.

There are no chirality outliers.

All (4) torsion outliers are listed below:

Mol	Chain	Res	Type	Atoms
2	C	1609	NGA	C1-C2-N2-C7
2	D	1609	NGA	O5-C5-C6-O6
2	D	1609	NGA	C4-C5-C6-O6
2	C	1609	NGA	C3-C2-N2-C7

There are no ring outliers.

1 monomer is involved in 1 short contact:

Mol	Chain	Res	Type	Clashes	Symm-Clashes
2	C	1609	NGA	1	0

## 5.7 Other polymers [i](#)

There are no such residues in this entry.

## 5.8 Polymer linkage issues [i](#)

There are no chain breaks in this entry.

## 6 Fit of model and data

### 6.1 Protein, DNA and RNA chains

In the following table, the column labelled ‘#RSRZ > 2’ contains the number (and percentage) of RSRZ outliers, followed by percent RSRZ outliers for the chain as percentile scores relative to all X-ray entries and entries of similar resolution. The OWAB column contains the minimum, median, 95<sup>th</sup> percentile and maximum values of the occupancy-weighted average B-factor per residue. The column labelled ‘Q < 0.9’ lists the number of (and percentage) of residues with an average occupancy less than 0.9.

Mol	Chain	Analysed	<RSRZ>	#RSRZ>2	OWAB(Å <sup>2</sup> )	Q<0.9
1	A	579/581 (99%)	-0.05	3 (0%) 91 81	21, 37, 68, 85	0
1	B	580/581 (99%)	0.01	6 (1%) 82 68	30, 47, 69, 83	0
1	C	578/581 (99%)	0.18	12 (2%) 63 46	32, 49, 82, 98	0
1	D	578/581 (99%)	0.22	21 (3%) 42 28	27, 52, 83, 102	0
All	All	2315/2324 (99%)	0.09	42 (1%) 68 51	21, 46, 78, 102	0

All (42) RSRZ outliers are listed below:

Mol	Chain	Res	Type	RSRZ
1	D	596	ALA	3.5
1	C	136	ASP	3.4
1	D	512	GLY	3.3
1	D	511	ARG	3.3
1	D	506	ASN	3.3
1	D	589	VAL	3.0
1	D	505	GLY	3.0
1	C	68	PHE	2.9
1	D	483	PHE	2.9
1	C	147	LEU	2.9
1	D	598	VAL	2.8
1	C	105	ASN	2.7
1	D	541	LEU	2.6
1	D	481	PHE	2.5
1	C	281	ARG	2.5
1	B	536	VAL	2.4
1	D	542	ASN	2.4
1	A	132	ILE	2.4
1	D	189	ILE	2.3
1	D	584	GLY	2.3
1	C	575	SER	2.3

*Continued on next page...*



*Continued from previous page...*

Mol	Chain	Res	Type	RSRZ
1	A	125	ALA	2.3
1	D	508	ILE	2.3
1	A	188	THR	2.3
1	B	560	THR	2.3
1	D	545	TRP	2.2
1	C	596	ALA	2.2
1	D	91	PHE	2.2
1	D	501	LEU	2.2
1	B	542	ASN	2.2
1	C	133	GLN	2.2
1	B	596	ALA	2.2
1	D	593	SER	2.1
1	D	563	ASP	2.1
1	C	98	SER	2.1
1	C	502	ASN	2.1
1	D	549	SER	2.1
1	B	543	VAL	2.1
1	B	91	PHE	2.1
1	D	120	ASP	2.0
1	C	121	PRO	2.0
1	C	504	SER	2.0

## 6.2 Non-standard residues in protein, DNA, RNA chains [i](#)

There are no non-standard protein/DNA/RNA residues in this entry.

## 6.3 Carbohydrates [i](#)

There are no monosaccharides in this entry.

## 6.4 Ligands [i](#)

In the following table, the Atoms column lists the number of modelled atoms in the group and the number defined in the chemical component dictionary. The B-factors column lists the minimum, median, 95<sup>th</sup> percentile and maximum values of B factors of atoms in the group. The column labelled 'Q< 0.9' lists the number of atoms with occupancy less than 0.9.

Mol	Type	Chain	Res	Atoms	RSCC	RSR	B-factors( $\text{\AA}^2$ )	Q<0.9
2	NGA	D	1609	15/15	0.71	0.32	74,84,91,95	0
3	13D	B	1613	5/5	0.82	0.33	45,46,50,56	0

*Continued on next page...*

*Continued from previous page...*

Mol	Type	Chain	Res	Atoms	RSCC	RSR	B-factors( $\text{\AA}^2$ )	Q<0.9
2	NGA	B	1612	15/15	0.90	0.23	54,62,67,68	0
2	NGA	A	1609	15/15	0.93	0.20	35,43,49,51	0
3	13D	A	1610	5/5	0.95	0.22	29,30,30,31	0
2	NGA	C	1609	15/15	0.95	0.22	42,45,48,49	0

## 6.5 Other polymers [i](#)

There are no such residues in this entry.