



Full wwPDB X-ray Structure Validation Report ⓘ

Sep 4, 2023 – 10:12 PM EDT

PDB ID : 3UFX
Title : Thermus aquaticus succinyl-CoA synthetase in complex with GDP-Mn²⁺
Authors : Fraser, M.E.
Deposited on : 2011-11-01
Resolution : 2.35 Å(reported)

This is a Full wwPDB X-ray Structure Validation Report for a publicly released PDB entry.

We welcome your comments at validation@mail.wwpdb.org

A user guide is available at

<https://www.wwpdb.org/validation/2017/XrayValidationReportHelp>

with specific help available everywhere you see the ⓘ symbol.

The types of validation reports are described at

<http://www.wwpdb.org/validation/2017/FAQs#types>.

The following versions of software and data (see [references ⓘ](#)) were used in the production of this report:

MolProbity : 4.02b-467
Mogul : 1.8.5 (274361), CSD as541be (2020)
Xtriage (Phenix) : 1.13
EDS : 2.35
buster-report : 1.1.7 (2018)
Percentile statistics : 20191225.v01 (using entries in the PDB archive December 25th 2019)
Refmac : 5.8.0158
CCP4 : 7.0.044 (Gargrove)
Ideal geometry (proteins) : Engh & Huber (2001)
Ideal geometry (DNA, RNA) : Parkinson et al. (1996)
Validation Pipeline (wwPDB-VP) : 2.35

1 Overall quality at a glance

The following experimental techniques were used to determine the structure:

X-RAY DIFFRACTION

The reported resolution of this entry is 2.35 Å.

Percentile scores (ranging between 0-100) for global validation metrics of the entry are shown in the following graphic. The table shows the number of entries on which the scores are based.

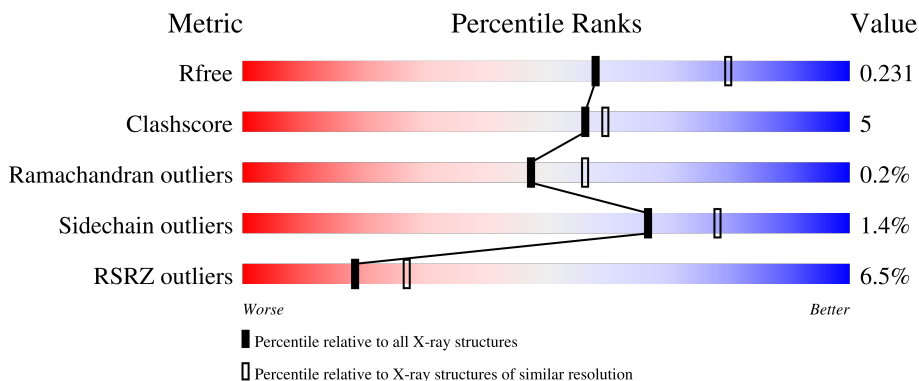



Metric	Whole archive (#Entries)	Similar resolution (#Entries, resolution range(Å))
R_{free}	130704	1164 (2.36-2.36)
Clashscore	141614	1232 (2.36-2.36)
Ramachandran outliers	138981	1211 (2.36-2.36)
Sidechain outliers	138945	1212 (2.36-2.36)
RSRZ outliers	127900	1150 (2.36-2.36)

The table below summarises the geometric issues observed across the polymeric chains and their fit to the electron density. The red, orange, yellow and green segments of the lower bar indicate the fraction of residues that contain outliers for ≥ 3 , 2, 1 and 0 types of geometric quality criteria respectively. A grey segment represents the fraction of residues that are not modelled. The numeric value for each fraction is indicated below the corresponding segment, with a dot representing fractions $\leq 5\%$. The upper red bar (where present) indicates the fraction of residues that have poor fit to the electron density. The numeric value is given above the bar.

Mol	Chain	Length	Quality of chain
1	A	296	90% 7% .
1	D	296	91% 6% .
1	F	296	91% 6% .
1	H	296	89% 9% .
2	B	397	6% 78% 17% 5%

Continued on next page...

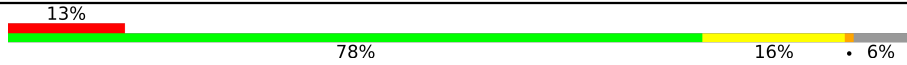
Continued from previous page...

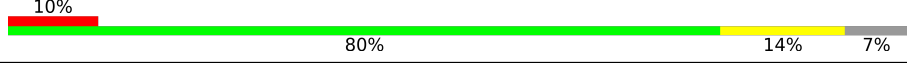
Mol	Chain	Length	Quality of chain
2	E	397	 <p>13% 78% 16% • 6%</p>
2	G	397	 <p>13% 77% 16% • 7%</p>
2	I	397	 <p>10% 80% 14% 7%</p>

2 Entry composition [i](#)

There are 5 unique types of molecules in this entry. The entry contains 20547 atoms, of which 0 are hydrogens and 0 are deuteriums.

In the tables below, the ZeroOcc column contains the number of atoms modelled with zero occupancy, the AltConf column contains the number of residues with at least one atom in alternate conformation and the Trace column contains the number of residues modelled with at most 2 atoms.

- Molecule 1 is a protein called succinyl-CoA synthetase alpha subunit.

Mol	Chain	Residues	Atoms					ZeroOcc	AltConf	Trace
			Total	C	N	O	S			
1	A	288	2091	1327	358	397	9	0	0	0
1	D	288	2091	1327	358	397	9	0	0	0
1	F	288	2091	1327	358	397	9	0	0	0
1	H	288	2091	1327	358	397	9	0	0	0

- Molecule 2 is a protein called Succinyl-CoA synthetase beta subunit.

Mol	Chain	Residues	Atoms					ZeroOcc	AltConf	Trace
			Total	C	N	O	S			
2	B	378	2863	1833	493	529	8	0	0	0
2	E	373	2836	1817	487	524	8	0	0	0
2	G	369	2810	1802	483	518	7	0	0	0
2	I	371	2823	1809	485	522	7	0	0	0

- Molecule 3 is GUANOSINE-5'-DIPHOSPHATE (three-letter code: GDP) (formula: C₁₀H₁₅N₅O₁₁P₂).

Continued from previous page...

Mol	Chain	Residues	Atoms		ZeroOcc	AltConf
5	B	82	Total 82	O 82	0	0
5	D	125	Total 125	O 125	0	0
5	E	81	Total 81	O 81	0	0
5	F	100	Total 100	O 100	0	0
5	G	67	Total 67	O 67	0	0
5	H	104	Total 104	O 104	0	0
5	I	74	Total 74	O 74	0	0

3 Residue-property plots [i](#)

These plots are drawn for all protein, RNA, DNA and oligosaccharide chains in the entry. The first graphic for a chain summarises the proportions of the various outlier classes displayed in the second graphic. The second graphic shows the sequence view annotated by issues in geometry and electron density. Residues are color-coded according to the number of geometric quality criteria for which they contain at least one outlier: green = 0, yellow = 1, orange = 2 and red = 3 or more. A red dot above a residue indicates a poor fit to the electron density ($RSRZ > 2$). Stretches of 2 or more consecutive residues without any outlier are shown as a green connector. Residues present in the sample, but not in the model, are shown in grey.

- Molecule 1: succinyl-CoA synthetase alpha subunit

Chain A:  90% 7%



- Molecule 1: succinyl-CoA synthetase alpha subunit

Chain D:  91% 6%



- Molecule 1: succinyl-CoA synthetase alpha subunit

Chain F:  91% 6%



- Molecule 1: succinyl-CoA synthetase alpha subunit

Chain H:  89% 9%

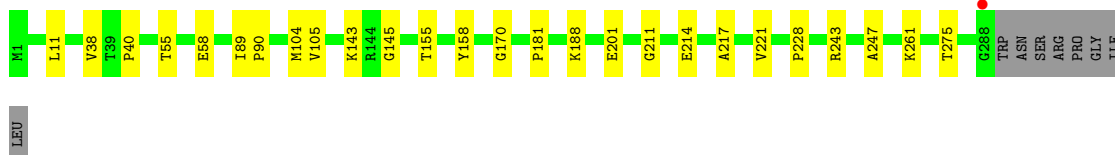

- Molecule 2: Succinyl-CoA synthetase beta subunit

Chain B:  6% 78% 17% 5%



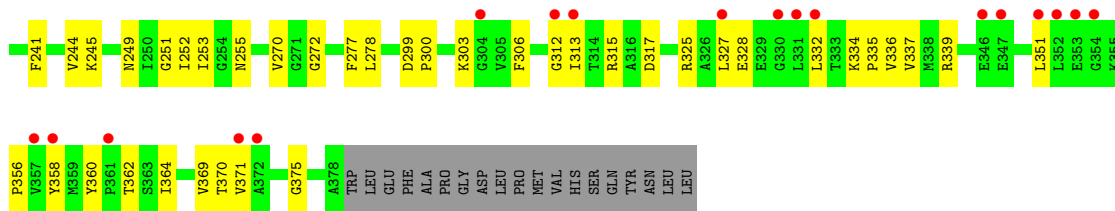

- Molecule 2: Succinyl-CoA synthetase beta subunit

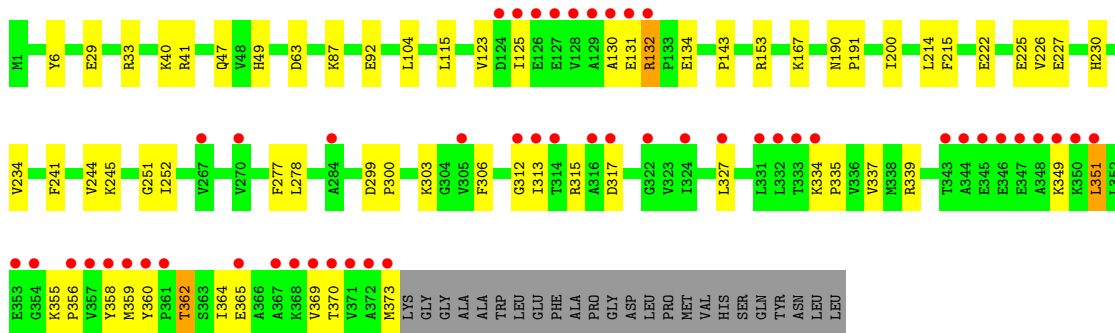
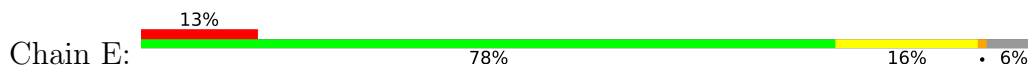

- Molecule 2: Succinyl-CoA synthetase beta subunit

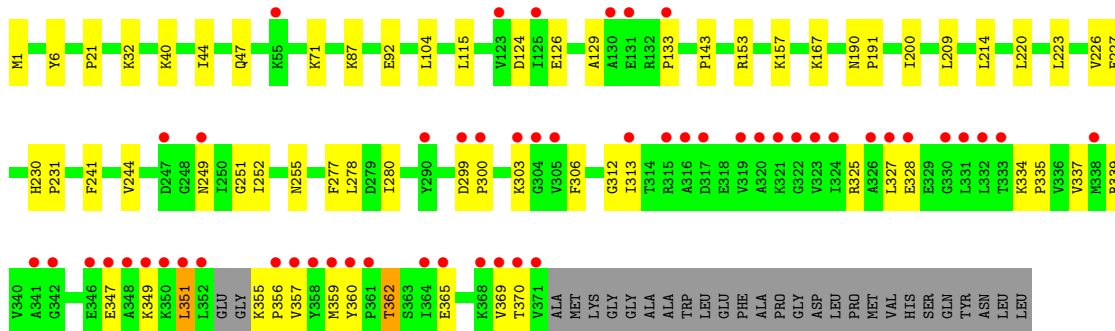
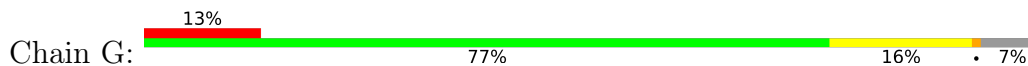

- Molecule 2: Succinyl-CoA synthetase beta subunit

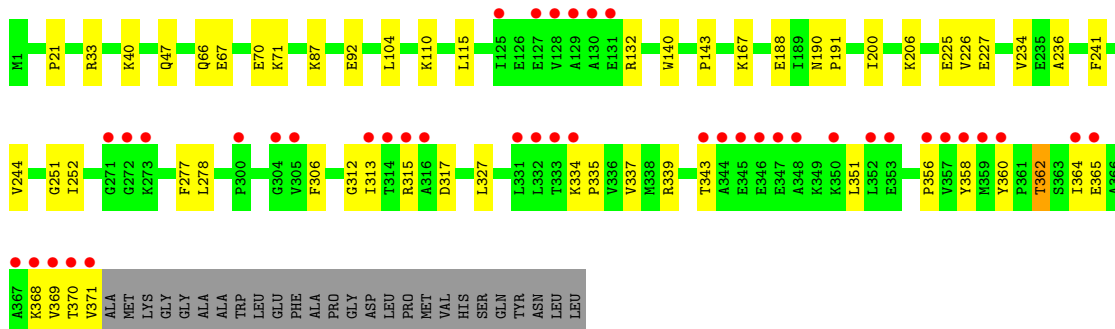
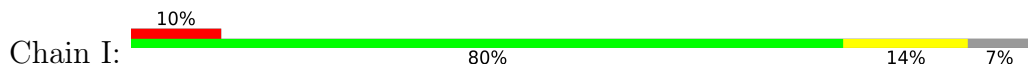

4 Data and refinement statistics i

Property	Value	Source
Space group	C 1 2 1	Depositor
Cell constants a, b, c, α , β , γ	261.70Å 126.80Å 110.60Å 90.00° 112.76° 90.00°	Depositor
Resolution (Å)	50.99 – 2.35 50.99 – 2.35	Depositor EDS
% Data completeness (in resolution range)	86.7 (50.99-2.35) 86.8 (50.99-2.35)	Depositor EDS
R_{merge}	0.13	Depositor
R_{sym}	(Not available)	Depositor
$\langle I/\sigma(I) \rangle$ ¹	1.73 (at 2.34Å)	Xtrriage
Refinement program	PHENIX 1.6.4_486	Depositor
R, R_{free}	0.204 , 0.245 0.189 , 0.231	Depositor DCC
R_{free} test set	6048 reflections (5.04%)	wwPDB-VP
Wilson B-factor (Å ²)	36.1	Xtrriage
Anisotropy	0.472	Xtrriage
Bulk solvent k_{sol} (e/Å ³), B_{sol} (Å ²)	0.32 , 40.5	EDS
L-test for twinning ²	$\langle L \rangle = 0.48$, $\langle L^2 \rangle = 0.31$	Xtrriage
Estimated twinning fraction	0.086 for -h-2*1,-k,l	Xtrriage
F_o, F_c correlation	0.94	EDS
Total number of atoms	20547	wwPDB-VP
Average B, all atoms (Å ²)	42.0	wwPDB-VP

Xtrriage's analysis on translational NCS is as follows: *The largest off-origin peak in the Patterson function is 3.21% of the height of the origin peak. No significant pseudotranslation is detected.*

¹Intensities estimated from amplitudes.

²Theoretical values of $\langle |L| \rangle$, $\langle L^2 \rangle$ for acentric reflections are 0.5, 0.333 respectively for untwinned datasets, and 0.375, 0.2 for perfectly twinned datasets.

5 Model quality [i](#)

5.1 Standard geometry [i](#)

Bond lengths and bond angles in the following residue types are not validated in this section: GDP, MN

The Z score for a bond length (or angle) is the number of standard deviations the observed value is removed from the expected value. A bond length (or angle) with $|Z| > 5$ is considered an outlier worth inspection. RMSZ is the root-mean-square of all Z scores of the bond lengths (or angles).

Mol	Chain	Bond lengths		Bond angles	
		RMSZ	# Z >5	RMSZ	# Z >5
1	A	0.38	0/2124	0.54	0/2878
1	D	0.42	0/2124	0.54	0/2878
1	F	0.39	0/2124	0.53	0/2878
1	H	0.41	0/2124	0.54	0/2878
2	B	0.38	0/2909	0.53	0/3931
2	E	0.38	0/2882	0.52	0/3896
2	G	0.38	0/2855	0.52	0/3859
2	I	0.39	0/2869	0.53	0/3879
All	All	0.39	0/20011	0.53	0/27077

There are no bond length outliers.

There are no bond angle outliers.

There are no chirality outliers.

There are no planarity outliers.

5.2 Too-close contacts [i](#)

In the following table, the Non-H and H(model) columns list the number of non-hydrogen atoms and hydrogen atoms in the chain respectively. The H(added) column lists the number of hydrogen atoms added and optimized by MolProbity. The Clashes column lists the number of clashes within the asymmetric unit, whereas Symm-Clashes lists symmetry-related clashes.

Mol	Chain	Non-H	H(model)	H(added)	Clashes	Symm-Clashes
1	A	2091	0	2163	15	0
1	D	2091	0	2163	13	0
1	F	2091	0	2163	12	0
1	H	2091	0	2163	18	0
2	B	2863	0	2965	44	1

Continued on next page...

Continued from previous page...

Mol	Chain	Non-H	H(model)	H(added)	Clashes	Symm-Clashes
2	E	2836	0	2936	39	0
2	G	2810	0	2912	43	0
2	I	2823	0	2922	33	0
3	B	28	0	12	0	0
3	E	28	0	12	0	0
3	G	28	0	12	0	0
3	I	28	0	12	0	0
4	B	1	0	0	0	0
4	E	1	0	0	0	0
4	G	1	0	0	0	0
4	I	1	0	0	0	0
5	A	102	0	0	3	0
5	B	82	0	0	2	0
5	D	125	0	0	2	0
5	E	81	0	0	1	0
5	F	100	0	0	2	0
5	G	67	0	0	0	0
5	H	104	0	0	3	0
5	I	74	0	0	0	0
All	All	20547	0	20435	202	1

The all-atom clashscore is defined as the number of clashes found per 1000 atoms (including hydrogen atoms). The all-atom clashscore for this structure is 5.

All (202) close contacts within the same asymmetric unit are listed below, sorted by their clash magnitude.

Atom-1	Atom-2	Interatomic distance (Å)	Clash overlap (Å)
2:E:132:ARG:HB3	2:E:134:GLU:OE2	1.86	0.76
2:I:110:LYS:HE3	2:I:140:TRP:CE2	2.24	0.73
1:A:42:LYS:HD2	1:A:45:MET:SD	2.30	0.71
2:B:272:GLY:HA3	2:B:371:VAL:HG22	1.73	0.70
1:D:11:LEU:HD11	1:D:38:VAL:HG23	1.76	0.68
1:H:11:LEU:HD11	1:H:38:VAL:HG23	1.80	0.64
2:B:225:GLU:HG2	2:B:234:VAL:HG11	1.83	0.61
1:H:181:PRO:HD2	5:H:301:HOH:O	2.01	0.61
1:A:11:LEU:HD11	1:A:38:VAL:HG23	1.84	0.59
2:B:364:ILE:HG13	5:B:650:HOH:O	2.02	0.59
1:F:104:MET:HG3	5:F:719:HOH:O	2.03	0.59
2:E:244:VAL:HB	2:E:277:PHE:HB3	1.85	0.59
1:F:11:LEU:HD11	1:F:38:VAL:HG23	1.84	0.59
2:B:244:VAL:HB	2:B:277:PHE:HB3	1.84	0.58

Continued on next page...

Continued from previous page...

Atom-1	Atom-2	Interatomic distance (Å)	Clash overlap (Å)
1:D:75:PRO:HG2	2:I:33:ARG:HD2	1.85	0.58
1:A:181:PRO:HD2	5:A:342:HOH:O	2.04	0.57
2:E:225:GLU:HG2	2:E:234:VAL:HG11	1.85	0.57
1:D:181:PRO:HD2	5:D:603:HOH:O	2.03	0.57
2:I:360:TYR:CZ	2:I:369:VAL:HG21	2.40	0.56
2:G:153:ARG:HD2	1:H:40:PRO:HB3	1.86	0.56
2:G:244:VAL:HB	2:G:277:PHE:HB3	1.87	0.56
2:B:272:GLY:CA	2:B:371:VAL:HG22	2.36	0.56
2:I:244:VAL:HB	2:I:277:PHE:HB3	1.87	0.55
2:B:227:GLU:OE1	2:B:227:GLU:HA	2.06	0.55
2:E:360:TYR:CZ	2:E:369:VAL:HG21	2.42	0.55
2:G:227:GLU:HA	2:G:227:GLU:OE1	2.06	0.55
2:E:29:GLU:O	2:E:33:ARG:HG2	2.06	0.55
2:G:360:TYR:CZ	2:G:369:VAL:HG21	2.41	0.54
1:F:181:PRO:HD2	5:F:324:HOH:O	2.06	0.54
2:E:167:LYS:HB2	2:E:200:ILE:HD12	1.89	0.54
2:E:227:GLU:HA	2:E:227:GLU:OE1	2.08	0.54
2:B:327:LEU:HD11	2:B:356:PRO:HD2	1.90	0.54
2:I:227:GLU:HA	2:I:227:GLU:OE1	2.07	0.54
2:I:167:LYS:HB2	2:I:200:ILE:HD12	1.90	0.53
2:E:339:ARG:C	2:E:339:ARG:HD2	2.30	0.53
1:F:214:GLU:OE1	1:F:261:LYS:HE3	2.09	0.53
2:I:337:VAL:HG21	2:I:370:THR:HG22	1.92	0.52
2:G:339:ARG:HD2	2:G:339:ARG:C	2.30	0.52
1:D:145:GLY:HA3	1:D:170:GLY:HA3	1.92	0.52
2:B:360:TYR:CZ	2:B:369:VAL:HG21	2.44	0.52
1:A:201:GLU:O	1:A:228:PRO:HD2	2.10	0.52
2:B:251:GLY:C	2:B:252:ILE:HD12	2.30	0.52
2:G:327:LEU:HD11	2:G:356:PRO:HD2	1.92	0.51
2:B:47:GLN:HB2	2:B:87:LYS:HG3	1.93	0.51
2:B:337:VAL:HG21	2:B:370:THR:HG22	1.93	0.51
2:G:47:GLN:HB2	2:G:87:LYS:HG3	1.92	0.51
2:E:251:GLY:C	2:E:252:ILE:HD12	2.31	0.51
1:F:201:GLU:O	1:F:228:PRO:HD2	2.11	0.51
2:G:249:ASN:O	2:G:303:LYS:HG2	2.10	0.51
2:E:327:LEU:HD11	2:E:356:PRO:HD2	1.92	0.51
2:G:167:LYS:HB2	2:G:200:ILE:HD12	1.91	0.51
2:I:225:GLU:HG2	2:I:234:VAL:HG11	1.92	0.51
1:F:145:GLY:HA3	1:F:170:GLY:HA3	1.93	0.51
1:H:105:VAL:HG12	2:I:143:PRO:HB3	1.93	0.50
2:B:153:ARG:HD2	1:D:40:PRO:HB3	1.93	0.50

Continued on next page...

Continued from previous page...

Atom-1	Atom-2	Interatomic distance (Å)	Clash overlap (Å)
2:G:40:LYS:HE3	2:G:92:GLU:OE2	2.10	0.50
1:A:105:VAL:HG12	2:B:143:PRO:HB3	1.93	0.50
2:I:251:GLY:C	2:I:252:ILE:HD12	2.32	0.50
2:E:130:ALA:O	2:E:131:GLU:C	2.50	0.50
2:G:251:GLY:C	2:G:252:ILE:HD12	2.31	0.50
2:B:127:GLU:HB3	2:B:131:GLU:OE2	2.11	0.50
2:B:167:LYS:HB2	2:B:200:ILE:HD12	1.93	0.50
2:I:327:LEU:HD11	2:I:356:PRO:HD2	1.94	0.50
2:E:40:LYS:HE3	2:E:92:GLU:OE2	2.12	0.50
2:I:241:PHE:HB3	2:I:278:LEU:HD11	1.94	0.50
2:I:339:ARG:HD2	2:I:339:ARG:C	2.33	0.50
2:E:337:VAL:HG21	2:E:370:THR:HG22	1.94	0.49
2:I:66:GLN:O	2:I:70:GLU:HG3	2.12	0.49
2:B:270:VAL:HG23	2:B:371:VAL:HG21	1.95	0.49
1:F:243:ARG:HD2	1:F:247:ALA:HA	1.95	0.49
2:G:124:ASP:OD1	2:G:126:GLU:HB3	2.12	0.49
2:I:315:ARG:HG2	2:I:343:THR:HB	1.95	0.49
2:B:303:LYS:HB2	2:B:375:GLY:HA3	1.95	0.48
1:A:18:ARG:HH21	2:G:32:LYS:NZ	2.12	0.48
1:H:145:GLY:HA3	1:H:170:GLY:HA3	1.94	0.48
1:H:188:LYS:HE3	5:H:643:HOH:O	2.12	0.48
1:F:42:LYS:HD2	1:F:45:MET:SD	2.53	0.48
2:B:40:LYS:HE3	2:B:92:GLU:OE2	2.13	0.47
1:D:243:ARG:HD2	1:D:247:ALA:HA	1.95	0.47
2:G:337:VAL:HG21	2:G:370:THR:HG22	1.96	0.47
2:I:110:LYS:HE3	2:I:140:TRP:CD2	2.50	0.47
2:B:339:ARG:HD2	2:B:339:ARG:C	2.35	0.47
2:G:157:LYS:HG3	1:H:58:GLU:OE2	2.13	0.47
2:I:67:GLU:O	2:I:71:LYS:HG2	2.15	0.47
2:E:337:VAL:HG13	2:E:360:TYR:HE2	1.79	0.47
1:H:243:ARG:HD2	1:H:247:ALA:HA	1.96	0.47
1:A:145:GLY:HA3	1:A:170:GLY:HA3	1.96	0.47
2:E:47:GLN:HB2	2:E:87:LYS:HG3	1.97	0.47
2:G:337:VAL:HG13	2:G:360:TYR:HE2	1.80	0.47
2:G:241:PHE:HB3	2:G:278:LEU:HD11	1.96	0.47
2:G:334:LYS:HB3	2:G:335:PRO:HD2	1.96	0.47
1:H:104:MET:HG3	5:H:318:HOH:O	2.15	0.47
1:H:201:GLU:O	1:H:228:PRO:HD2	2.15	0.47
2:I:40:LYS:HE3	2:I:92:GLU:OE2	2.15	0.47
2:I:368:LYS:O	2:I:371:VAL:HB	2.15	0.47
2:I:132:ARG:HH11	2:I:132:ARG:HG3	1.80	0.46

Continued on next page...

Continued from previous page...

Atom-1	Atom-2	Interatomic distance (Å)	Clash overlap (Å)
2:E:349:LYS:HD3	2:E:359:MET:HB2	1.97	0.46
1:A:106:ARG:HD3	5:B:433:HOH:O	2.15	0.46
1:F:105:VAL:HG12	2:G:143:PRO:HB3	1.97	0.46
2:G:129:ALA:O	2:G:133:PRO:HG3	2.16	0.46
2:E:337:VAL:HG13	2:E:360:TYR:CE2	2.51	0.46
2:G:325:ARG:O	2:G:328:GLU:HG2	2.15	0.45
2:B:21:PRO:HG2	2:B:92:GLU:CD	2.37	0.45
1:D:18:ARG:HB3	1:D:18:ARG:CZ	2.46	0.45
2:I:337:VAL:HG13	2:I:360:TYR:HE2	1.80	0.45
1:H:155:THR:HA	1:H:158:TYR:CD2	2.52	0.45
1:A:104:MET:HG3	5:A:360:HOH:O	2.17	0.45
2:G:337:VAL:HG13	2:G:360:TYR:CE2	2.52	0.45
2:I:334:LYS:HB3	2:I:335:PRO:HD2	1.99	0.45
1:A:243:ARG:HD2	1:A:247:ALA:HA	1.99	0.45
1:D:201:GLU:O	1:D:228:PRO:HD2	2.15	0.45
2:E:299:ASP:HA	2:E:300:PRO:HD2	1.78	0.45
2:G:299:ASP:HA	2:G:300:PRO:HD2	1.76	0.45
1:D:275:THR:HG21	2:E:364:ILE:HD11	1.99	0.45
2:E:351:LEU:HD12	2:E:351:LEU:HA	1.83	0.45
2:I:337:VAL:HG13	2:I:360:TYR:CE2	2.52	0.45
2:I:337:VAL:CG2	2:I:370:THR:HG22	2.47	0.45
2:B:124:ASP:HB3	2:B:127:GLU:HG3	1.98	0.44
1:A:214:GLU:OE1	1:A:261:LYS:HE3	2.17	0.44
1:H:214:GLU:OE1	1:H:261:LYS:HE3	2.18	0.44
2:I:47:GLN:HB2	2:I:87:LYS:HG3	2.00	0.44
2:E:334:LYS:HB3	2:E:335:PRO:HD2	1.99	0.44
2:B:334:LYS:HB3	2:B:335:PRO:HD2	2.00	0.44
2:B:337:VAL:CG2	2:B:370:THR:HG22	2.47	0.44
2:E:241:PHE:HB3	2:E:278:LEU:HD11	2.00	0.44
1:F:155:THR:HG21	2:G:255:ASN:O	2.17	0.44
2:B:41:ARG:NH2	2:B:95:ASP:OD1	2.50	0.44
1:H:217:ALA:O	1:H:221:VAL:HG23	2.18	0.44
2:B:337:VAL:HG13	2:B:360:TYR:HE2	1.83	0.44
1:A:155:THR:HA	1:A:158:TYR:CD2	2.53	0.43
2:E:214:LEU:HD23	2:E:214:LEU:HA	1.89	0.43
2:E:337:VAL:CG2	2:E:370:THR:HG22	2.48	0.43
1:D:214:GLU:OE1	1:D:261:LYS:HE3	2.17	0.43
2:B:6:TYR:HD1	2:B:47:GLN:OE1	2.02	0.43
2:E:303:LYS:O	2:E:334:LYS:HB3	2.18	0.43
2:G:21:PRO:HG2	2:G:92:GLU:CD	2.38	0.43
2:G:104:LEU:HD23	2:G:115:LEU:HA	1.99	0.43

Continued on next page...

Continued from previous page...

Atom-1	Atom-2	Interatomic distance (Å)	Clash overlap (Å)
2:B:222:GLU:OE2	2:G:6:TYR:OH	2.31	0.43
1:D:155:THR:HA	1:D:158:TYR:CD2	2.54	0.43
2:E:315:ARG:NH1	2:E:317:ASP:OD2	2.52	0.43
2:I:104:LEU:HD23	2:I:115:LEU:HA	2.00	0.43
2:I:188:GLU:HG3	2:I:206:LYS:HB3	2.00	0.43
2:E:41:ARG:CZ	2:E:63:ASP:OD1	2.66	0.43
2:E:125:ILE:HD12	2:E:125:ILE:HA	1.86	0.43
1:H:55:THR:OG1	1:H:58:GLU:HG3	2.19	0.43
2:I:236:ALA:HB1	2:I:241:PHE:HB2	2.01	0.43
2:I:327:LEU:O	2:I:327:LEU:HD23	2.19	0.43
2:G:44:ILE:HG13	2:G:71:LYS:HB3	2.02	0.42
1:H:89:ILE:HA	1:H:90:PRO:HD3	1.86	0.42
1:H:143:LYS:HB3	1:H:143:LYS:HE2	1.81	0.42
1:A:89:ILE:HA	1:A:90:PRO:HD3	1.84	0.42
2:B:241:PHE:HB3	2:B:278:LEU:HD11	2.01	0.42
2:B:315:ARG:HD3	2:B:317:ASP:OD2	2.19	0.42
1:F:155:THR:HA	1:F:158:TYR:CD2	2.53	0.42
1:A:155:THR:HG21	2:B:255:ASN:O	2.19	0.42
2:B:236:ALA:HB1	2:B:241:PHE:HB2	2.02	0.42
2:B:337:VAL:HG13	2:B:360:TYR:CE2	2.55	0.42
2:B:249:ASN:O	2:B:303:LYS:HG2	2.19	0.42
2:E:104:LEU:HD23	2:E:115:LEU:HA	2.02	0.42
1:F:143:LYS:HE3	1:F:143:LYS:HB2	1.89	0.42
2:G:362:THR:HG23	2:G:365:GLU:CB	2.50	0.42
1:A:42:LYS:O	1:A:45:MET:HB2	2.20	0.42
2:E:49:HIS:NE2	2:E:227:GLU:OE1	2.44	0.42
2:E:153:ARG:HD3	5:E:644:HOH:O	2.19	0.42
2:E:190:ASN:HA	2:E:191:PRO:HA	1.82	0.42
2:B:325:ARG:HA	2:B:328:GLU:HG2	2.01	0.41
2:E:370:THR:HA	2:E:373:MET:SD	2.60	0.41
2:G:337:VAL:CG2	2:G:370:THR:HG22	2.50	0.41
2:G:351:LEU:HD12	2:G:351:LEU:HA	1.80	0.41
1:H:275:THR:HG21	2:I:364:ILE:HD11	2.01	0.41
2:E:215:PHE:CD1	2:E:215:PHE:C	2.94	0.41
2:I:362:THR:HG23	2:I:365:GLU:CB	2.50	0.41
2:B:332:LEU:HD11	2:B:336:VAL:HG21	2.02	0.41
1:D:104:MET:HG3	5:D:329:HOH:O	2.20	0.41
1:D:105:VAL:HG12	2:E:143:PRO:HB3	2.01	0.41
2:G:1:MET:HE1	2:G:223:LEU:HB2	2.02	0.41
2:G:241:PHE:CD1	2:G:280:ILE:HA	2.55	0.41
2:B:188:GLU:HG3	2:B:206:LYS:HB3	2.02	0.41

Continued on next page...

Continued from previous page...

Atom-1	Atom-2	Interatomic distance (Å)	Clash overlap (Å)
2:G:1:MET:CE	2:G:223:LEU:HB2	2.51	0.41
2:I:21:PRO:HG2	2:I:92:GLU:CD	2.41	0.41
2:E:362:THR:HG23	2:E:365:GLU:CB	2.51	0.41
2:B:230:HIS:CD2	2:B:245:LYS:HG2	2.55	0.41
2:E:6:TYR:HD1	2:E:47:GLN:OE1	2.04	0.41
2:G:6:TYR:HD1	2:G:47:GLN:OE1	2.03	0.41
2:G:327:LEU:HD23	2:G:327:LEU:O	2.20	0.41
2:B:225:GLU:OE2	2:G:87:LYS:HE2	2.20	0.41
2:G:214:LEU:HD23	2:G:214:LEU:HA	1.91	0.41
2:E:230:HIS:CD2	2:E:245:LYS:HG2	2.57	0.40
2:G:190:ASN:HA	2:G:191:PRO:HA	1.84	0.40
2:I:190:ASN:HA	2:I:191:PRO:HA	1.83	0.40
2:B:104:LEU:HD23	2:B:115:LEU:HA	2.02	0.40
2:B:327:LEU:HD23	2:B:327:LEU:O	2.22	0.40
2:E:327:LEU:HD23	2:E:327:LEU:O	2.20	0.40
2:B:299:ASP:HA	2:B:300:PRO:HD2	1.74	0.40
2:G:209:LEU:HD11	2:G:220:LEU:HD13	2.03	0.40
2:G:230:HIS:ND1	2:G:231:PRO:HD2	2.35	0.40
2:G:349:LYS:HD3	2:G:359:MET:HB2	2.03	0.40
5:A:297:HOH:O	2:B:111:LYS:HE2	2.22	0.40
2:B:132:ARG:HB3	2:B:134:GLU:OE2	2.21	0.40
2:B:253:ILE:HG12	2:B:278:LEU:HD23	2.04	0.40
2:G:355:LYS:C	2:G:357:VAL:H	2.25	0.40
1:H:211:GLY:O	1:H:261:LYS:NZ	2.55	0.40

All (1) symmetry-related close contacts are listed below. The label for Atom-2 includes the symmetry operator and encoded unit-cell translations to be applied.

Atom-1	Atom-2	Interatomic distance (Å)	Clash overlap (Å)
2:B:358:TYR:OH	2:B:358:TYR:OH[2_657]	2.14	0.06

5.3 Torsion angles [i](#)

5.3.1 Protein backbone [i](#)

In the following table, the Percentiles column shows the percent Ramachandran outliers of the chain as a percentile score with respect to all X-ray entries followed by that with respect to entries of similar resolution.

The Analysed column shows the number of residues for which the backbone conformation was

analysed, and the total number of residues.

Mol	Chain	Analysed	Favoured	Allowed	Outliers	Percentiles	
1	A	286/296 (97%)	273 (96%)	13 (4%)	0	100	100
1	D	286/296 (97%)	275 (96%)	11 (4%)	0	100	100
1	F	286/296 (97%)	274 (96%)	12 (4%)	0	100	100
1	H	286/296 (97%)	276 (96%)	10 (4%)	0	100	100
2	B	376/397 (95%)	366 (97%)	8 (2%)	2 (0%)	29	32
2	E	371/397 (94%)	359 (97%)	11 (3%)	1 (0%)	41	47
2	G	365/397 (92%)	356 (98%)	8 (2%)	1 (0%)	41	47
2	I	369/397 (93%)	360 (98%)	8 (2%)	1 (0%)	41	47
All	All	2625/2772 (95%)	2539 (97%)	81 (3%)	5 (0%)	47	56

All (5) Ramachandran outliers are listed below:

Mol	Chain	Res	Type
2	B	131	GLU
2	B	312	GLY
2	E	312	GLY
2	G	312	GLY
2	I	312	GLY

5.3.2 Protein sidechains [i](#)

In the following table, the Percentiles column shows the percent sidechain outliers of the chain as a percentile score with respect to all X-ray entries followed by that with respect to entries of similar resolution.

The Analysed column shows the number of residues for which the sidechain conformation was analysed, and the total number of residues.

Mol	Chain	Analysed	Rotameric	Outliers	Percentiles	
1	A	216/223 (97%)	216 (100%)	0	100	100
1	D	216/223 (97%)	216 (100%)	0	100	100
1	F	216/223 (97%)	216 (100%)	0	100	100
1	H	216/223 (97%)	216 (100%)	0	100	100
2	B	289/306 (94%)	283 (98%)	6 (2%)	53	65
2	E	288/306 (94%)	278 (96%)	10 (4%)	36	44
2	G	286/306 (94%)	280 (98%)	6 (2%)	53	65

Continued on next page...

Continued from previous page...

Mol	Chain	Analysed	Rotameric	Outliers	Percentiles
2	I	287/306 (94%)	280 (98%)	7 (2%)	49 59
All	All	2014/2116 (95%)	1985 (99%)	29 (1%)	67 78

All (29) residues with a non-rotameric sidechain are listed below:

Mol	Chain	Res	Type
2	B	219	ASP
2	B	226	VAL
2	B	306	PHE
2	B	313	ILE
2	B	351	LEU
2	B	362	THR
2	E	123	VAL
2	E	132	ARG
2	E	222	GLU
2	E	226	VAL
2	E	306	PHE
2	E	313	ILE
2	E	351	LEU
2	E	355	LYS
2	E	358	TYR
2	E	362	THR
2	G	226	VAL
2	G	306	PHE
2	G	313	ILE
2	G	347	GLU
2	G	351	LEU
2	G	362	THR
2	I	226	VAL
2	I	306	PHE
2	I	313	ILE
2	I	317	ASP
2	I	351	LEU
2	I	358	TYR
2	I	362	THR

Sometimes sidechains can be flipped to improve hydrogen bonding and reduce clashes. All (4) such sidechains are listed below:

Mol	Chain	Res	Type
2	E	166	ASN
1	F	26	GLN

Continued on next page...

Continued from previous page...

Mol	Chain	Res	Type
2	G	276	ASN
1	H	224	HIS

5.3.3 RNA [i](#)

There are no RNA molecules in this entry.

5.4 Non-standard residues in protein, DNA, RNA chains [i](#)

There are no non-standard protein/DNA/RNA residues in this entry.

5.5 Carbohydrates [i](#)

There are no monosaccharides in this entry.

5.6 Ligand geometry [i](#)

Of 8 ligands modelled in this entry, 4 are monoatomic - leaving 4 for Mogul analysis.

In the following table, the Counts columns list the number of bonds (or angles) for which Mogul statistics could be retrieved, the number of bonds (or angles) that are observed in the model and the number of bonds (or angles) that are defined in the Chemical Component Dictionary. The Link column lists molecule types, if any, to which the group is linked. The Z score for a bond length (or angle) is the number of standard deviations the observed value is removed from the expected value. A bond length (or angle) with $|Z| > 2$ is considered an outlier worth inspection. RMSZ is the root-mean-square of all Z scores of the bond lengths (or angles).

Mol	Type	Chain	Res	Link	Bond lengths			Bond angles		
					Counts	RMSZ	# Z > 2	Counts	RMSZ	# Z > 2
3	GDP	I	398	4	24,30,30	0.89	1 (4%)	30,47,47	1.15	4 (13%)
3	GDP	G	398	4	24,30,30	0.96	2 (8%)	30,47,47	1.36	4 (13%)
3	GDP	B	398	4	24,30,30	0.91	0	30,47,47	1.41	5 (16%)
3	GDP	E	398	4	24,30,30	0.94	1 (4%)	30,47,47	1.16	4 (13%)

In the following table, the Chirals column lists the number of chiral outliers, the number of chiral centers analysed, the number of these observed in the model and the number defined in the Chemical Component Dictionary. Similar counts are reported in the Torsion and Rings columns. '-' means no outliers of that kind were identified.

Mol	Type	Chain	Res	Link	Chirals	Torsions	Rings
3	GDP	I	398	4	-	1/12/32/32	0/3/3/3
3	GDP	G	398	4	-	2/12/32/32	0/3/3/3
3	GDP	B	398	4	-	5/12/32/32	0/3/3/3
3	GDP	E	398	4	-	3/12/32/32	0/3/3/3

All (4) bond length outliers are listed below:

Mol	Chain	Res	Type	Atoms	Z	Observed(Å)	Ideal(Å)
3	I	398	GDP	C6-N1	-2.37	1.34	1.37
3	E	398	GDP	O4'-C1'	2.22	1.44	1.41
3	G	398	GDP	O4'-C1'	2.08	1.44	1.41
3	G	398	GDP	C6-N1	-2.03	1.34	1.37

All (17) bond angle outliers are listed below:

Mol	Chain	Res	Type	Atoms	Z	Observed(°)	Ideal(°)
3	B	398	GDP	C3'-C2'-C1'	4.34	107.51	100.98
3	G	398	GDP	C3'-C2'-C1'	3.89	106.84	100.98
3	G	398	GDP	PA-O3A-PB	-3.03	122.44	132.83
3	I	398	GDP	C5-C6-N1	2.59	118.53	113.95
3	E	398	GDP	O3B-PB-O3A	2.55	113.18	104.64
3	E	398	GDP	C5-C6-N1	2.54	118.44	113.95
3	B	398	GDP	O3B-PB-O3A	2.53	113.11	104.64
3	E	398	GDP	C3'-C2'-C1'	2.51	104.75	100.98
3	B	398	GDP	C5-C6-N1	2.49	118.36	113.95
3	B	398	GDP	C8-N7-C5	2.46	107.68	102.99
3	G	398	GDP	C5-C6-N1	2.44	118.25	113.95
3	I	398	GDP	O3B-PB-O3A	2.42	112.76	104.64
3	G	398	GDP	C8-N7-C5	2.30	107.38	102.99
3	I	398	GDP	C3'-C2'-C1'	2.26	104.39	100.98
3	I	398	GDP	C8-N7-C5	2.25	107.28	102.99
3	E	398	GDP	C8-N7-C5	2.24	107.25	102.99
3	B	398	GDP	PA-O3A-PB	-2.03	125.85	132.83

There are no chirality outliers.

All (11) torsion outliers are listed below:

Mol	Chain	Res	Type	Atoms
3	E	398	GDP	PA-O3A-PB-O3B
3	B	398	GDP	O4'-C4'-C5'-O5'
3	B	398	GDP	C3'-C4'-C5'-O5'

Continued on next page...

Continued from previous page...

Mol	Chain	Res	Type	Atoms
3	B	398	GDP	PA-O3A-PB-O1B
3	G	398	GDP	PA-O3A-PB-O1B
3	B	398	GDP	PA-O3A-PB-O3B
3	E	398	GDP	PB-O3A-PA-O2A
3	G	398	GDP	PB-O3A-PA-O2A
3	I	398	GDP	PB-O3A-PA-O2A
3	E	398	GDP	PA-O3A-PB-O1B
3	B	398	GDP	C5'-O5'-PA-O1A

There are no ring outliers.

No monomer is involved in short contacts.

The following is a two-dimensional graphical depiction of Mogul quality analysis of bond lengths, bond angles, torsion angles, and ring geometry for all instances of the Ligand of Interest. In addition, ligands with molecular weight > 250 and outliers as shown on the validation Tables will also be included. For torsion angles, if less than 5% of the Mogul distribution of torsion angles is within 10 degrees of the torsion angle in question, then that torsion angle is considered an outlier. Any bond that is central to one or more torsion angles identified as an outlier by Mogul will be highlighted in the graph. For rings, the root-mean-square deviation (RMSD) between the ring in question and similar rings identified by Mogul is calculated over all ring torsion angles. If the average RMSD is greater than 60 degrees and the minimal RMSD between the ring in question and any Mogul-identified rings is also greater than 60 degrees, then that ring is considered an outlier. The outliers are highlighted in purple. The color gray indicates Mogul did not find sufficient equivalents in the CSD to analyse the geometry.

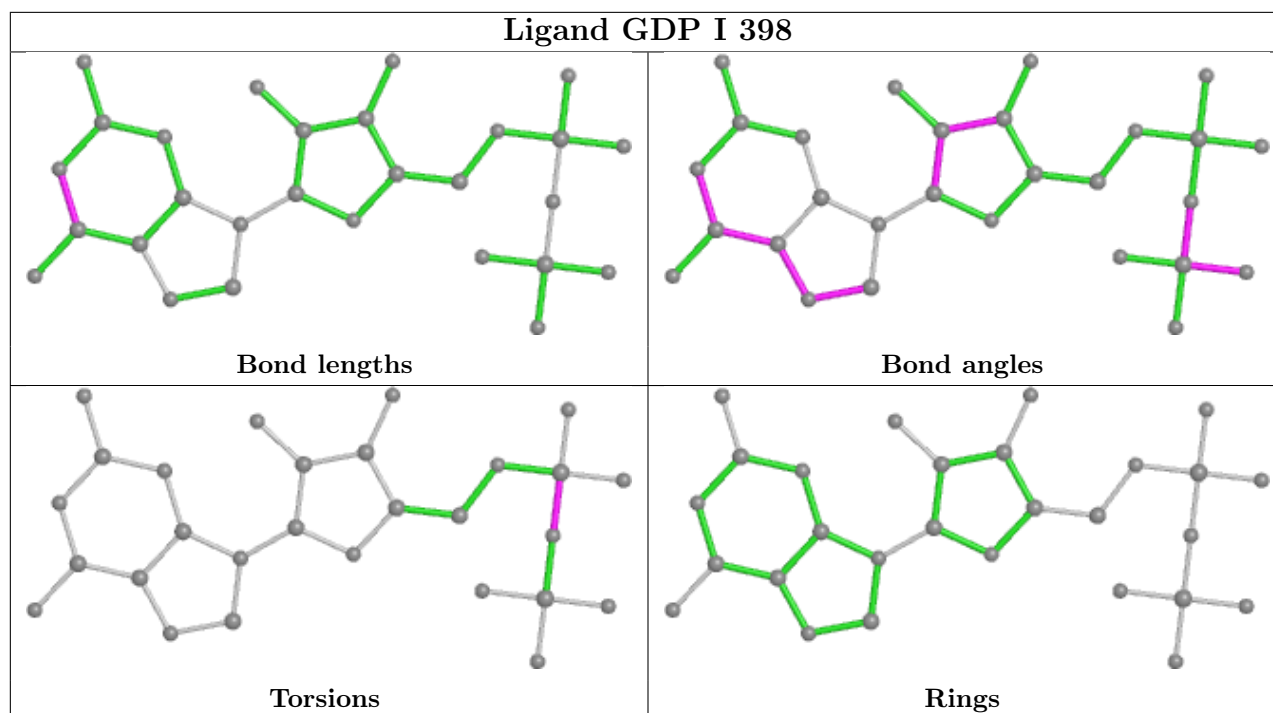

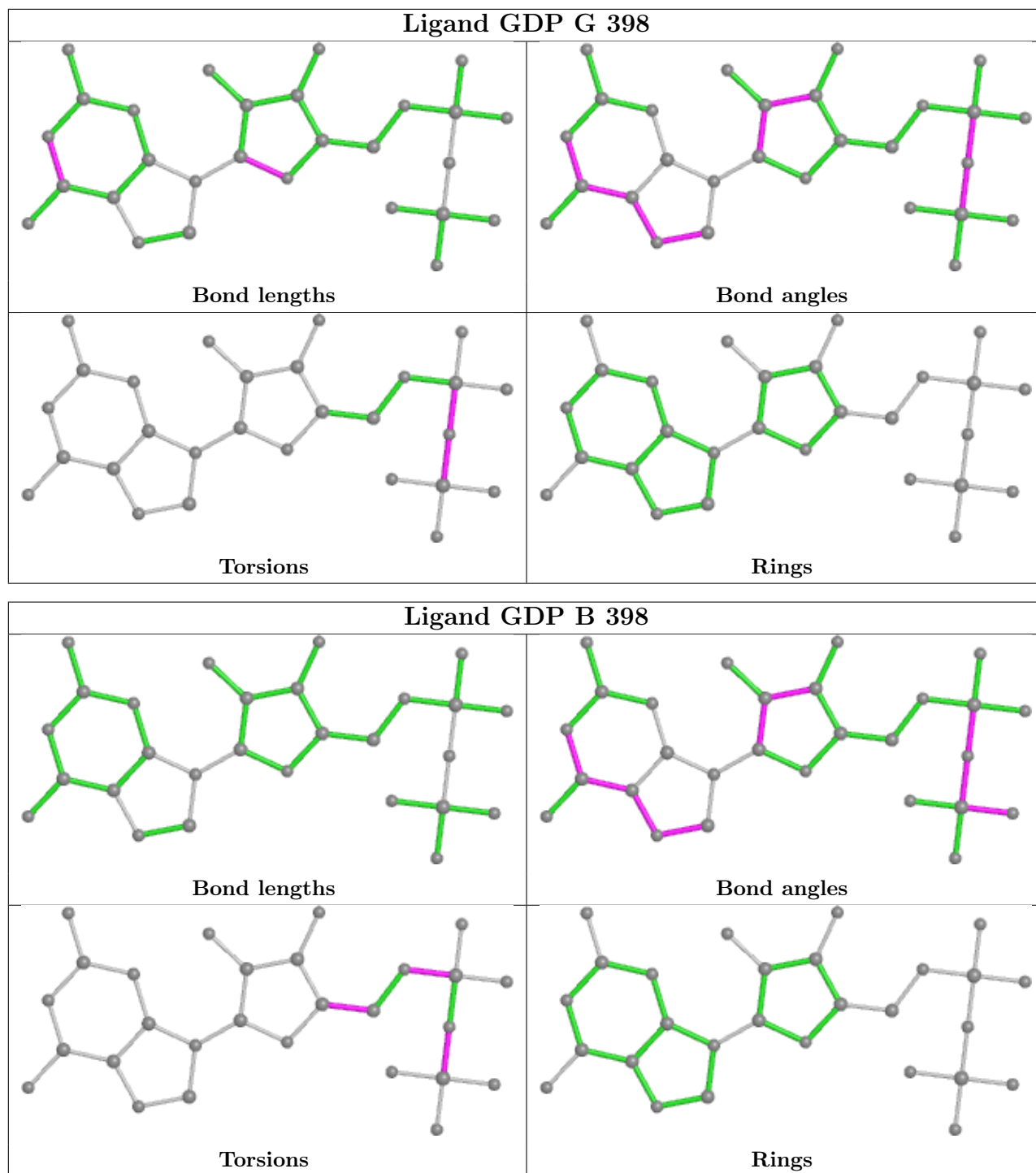

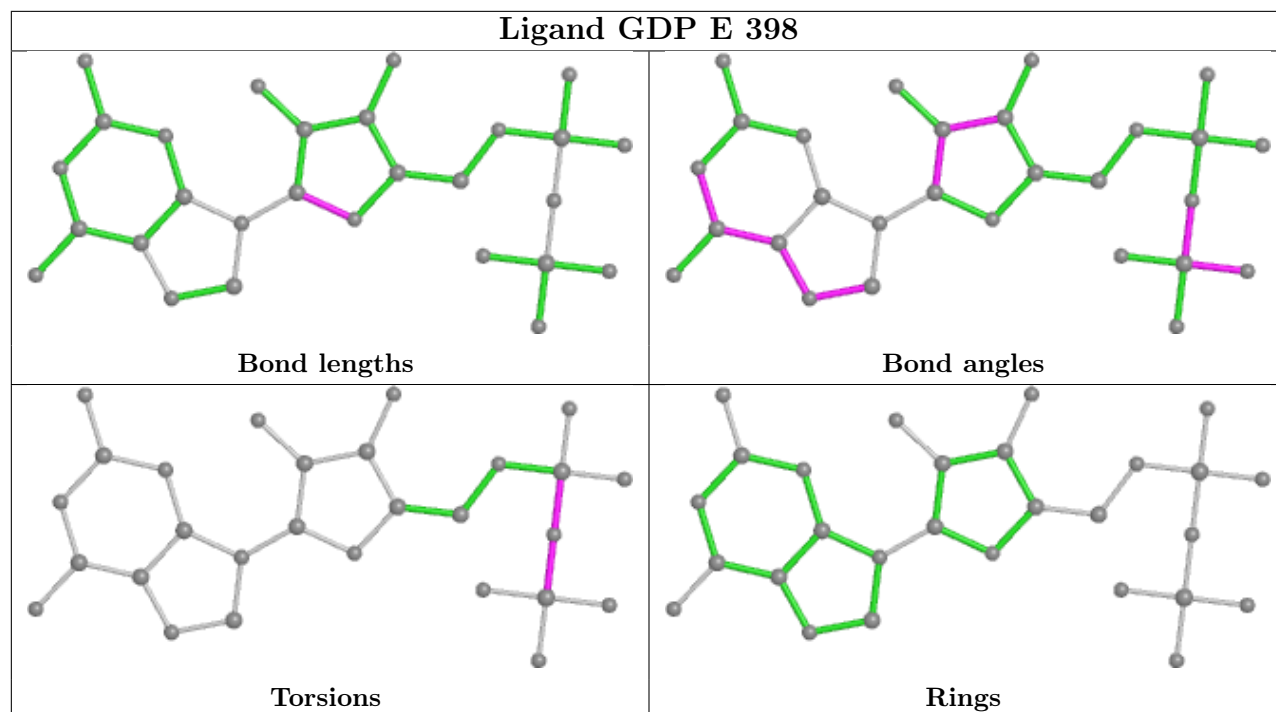

5.7 Other polymers [i](#)

There are no such residues in this entry.

5.8 Polymer linkage issues [i](#)

There are no chain breaks in this entry.

6 Fit of model and data

6.1 Protein, DNA and RNA chains

In the following table, the column labelled ‘#RSRZ > 2’ contains the number (and percentage) of RSRZ outliers, followed by percent RSRZ outliers for the chain as percentile scores relative to all X-ray entries and entries of similar resolution. The OWAB column contains the minimum, median, 95th percentile and maximum values of the occupancy-weighted average B-factor per residue. The column labelled ‘Q < 0.9’ lists the number of (and percentage) of residues with an average occupancy less than 0.9.

Mol	Chain	Analysed	<RSRZ>	#RSRZ>2	OWAB(Å ²)	Q<0.9
1	A	288/296 (97%)	0.05	1 (0%) 94 97	20, 32, 51, 70	0
1	D	288/296 (97%)	0.10	1 (0%) 94 97	20, 31, 52, 72	0
1	F	288/296 (97%)	0.05	2 (0%) 87 92	21, 33, 54, 84	0
1	H	288/296 (97%)	0.02	1 (0%) 94 97	19, 31, 52, 87	0
2	B	378/397 (95%)	0.40	24 (6%) 20 29	22, 43, 82, 117	0
2	E	373/397 (93%)	0.56	50 (13%) 3 4	21, 43, 87, 118	0
2	G	369/397 (92%)	0.77	53 (14%) 2 4	23, 44, 88, 119	0
2	I	371/397 (93%)	0.55	41 (11%) 5 8	21, 44, 87, 118	0
All	All	2643/2772 (95%)	0.34	173 (6%) 18 27	19, 37, 79, 119	0

All (173) RSRZ outliers are listed below:

Mol	Chain	Res	Type	RSRZ
2	G	324	ILE	9.1
2	G	330	GLY	9.0
2	G	358	TYR	7.3
2	I	314	THR	7.2
2	G	332	LEU	7.1
2	G	313	ILE	6.3
2	E	313	ILE	6.3
2	G	346	GLU	6.2
2	G	351	LEU	6.0
2	G	305	VAL	5.8
2	I	358	TYR	5.8
2	E	371	VAL	5.6
2	G	323	VAL	5.6
2	E	358	TYR	5.5
2	E	346	GLU	5.5
2	G	360	TYR	5.5

Continued on next page...

Continued from previous page...

Mol	Chain	Res	Type	RSRZ
2	G	331	LEU	5.3
2	G	333	THR	5.2
2	I	333	THR	5.1
2	I	368	LYS	5.0
2	B	133	PRO	5.0
2	G	371	VAL	4.9
2	G	352	LEU	4.8
2	B	330	GLY	4.8
2	G	357	VAL	4.8
2	E	348	ALA	4.7
2	G	320	ALA	4.7
2	I	313	ILE	4.6
2	I	127	GLU	4.5
2	I	371	VAL	4.5
2	I	347	GLU	4.5
2	B	358	TYR	4.5
2	G	350	LYS	4.4
1	F	288	GLY	4.3
2	I	356	PRO	4.3
2	E	360	TYR	4.2
2	G	321	LYS	4.2
2	G	316	ALA	4.2
1	A	288	GLY	4.2
2	B	346	GLU	4.1
2	I	346	GLU	4.1
2	I	125	ILE	4.1
2	I	315	ARG	4.1
2	G	356	PRO	4.0
2	G	327	LEU	3.9
2	E	350	LYS	3.8
2	E	322	GLY	3.8
2	G	347	GLU	3.8
2	I	367	ALA	3.8
2	I	129	ALA	3.8
2	G	359	MET	3.8
2	B	313	ILE	3.7
2	E	369	VAL	3.6
2	E	356	PRO	3.6
2	E	125	ILE	3.6
1	H	288	GLY	3.5
2	G	304	GLY	3.5
2	E	127	GLU	3.5

Continued on next page...

Continued from previous page...

Mol	Chain	Res	Type	RSRZ
2	I	353	GLU	3.5
2	B	351	LEU	3.4
2	B	357	VAL	3.4
2	G	349	LYS	3.4
2	E	349	LYS	3.4
2	B	372	ALA	3.3
2	I	360	TYR	3.3
2	E	312	GLY	3.3
2	G	365	GLU	3.3
2	E	333	THR	3.3
2	I	348	ALA	3.3
2	B	331	LEU	3.3
2	G	348	ALA	3.3
2	I	128	VAL	3.3
2	E	314	THR	3.3
2	I	359	MET	3.2
2	I	305	VAL	3.2
2	G	342	GLY	3.2
2	E	368	LYS	3.2
2	E	344	ALA	3.2
2	B	352	LEU	3.2
2	G	131	GLU	3.2
2	E	129	ALA	3.2
2	B	128	VAL	3.1
2	I	365	GLU	3.1
2	B	327	LEU	3.1
2	G	300	PRO	3.1
2	G	130	ALA	3.1
2	G	317	ASP	3.1
2	B	312	GLY	3.1
2	E	361	PRO	3.0
2	B	353	GLU	3.0
2	E	370	THR	3.0
2	I	364	ILE	3.0
2	I	316	ALA	3.0
2	I	343	THR	3.0
2	B	131	GLU	2.9
2	E	131	GLU	2.9
2	B	125	ILE	2.9
2	E	353	GLU	2.9
2	G	368	LYS	2.9
2	G	125	ILE	2.9

Continued on next page...

Continued from previous page...

Mol	Chain	Res	Type	RSRZ
2	E	365	GLU	2.9
2	G	370	THR	2.8
2	I	350	LYS	2.8
2	G	338	MET	2.8
2	I	130	ALA	2.8
2	I	370	THR	2.8
2	E	270	VAL	2.8
2	E	324	ILE	2.8
2	I	304	GLY	2.7
2	G	123	VAL	2.7
2	B	361	PRO	2.7
2	E	347	GLU	2.7
2	E	372	ALA	2.7
2	E	367	ALA	2.7
2	B	371	VAL	2.7
2	E	305	VAL	2.7
2	I	273	LYS	2.6
2	E	354	GLY	2.6
2	I	352	LEU	2.6
2	B	132	ARG	2.6
2	G	249	ASN	2.6
2	I	357	VAL	2.6
2	E	332	LEU	2.6
2	E	327	LEU	2.6
2	G	364	ILE	2.6
2	G	315	ARG	2.5
2	E	128	VAL	2.5
2	I	369	VAL	2.5
2	B	354	GLY	2.5
2	E	130	ALA	2.5
2	I	271	GLY	2.4
2	G	299	ASP	2.4
2	B	347	GLU	2.4
2	I	331	LEU	2.4
2	E	373	MET	2.4
2	G	328	GLU	2.4
2	G	303	LYS	2.4
2	G	361	PRO	2.4
2	I	344	ALA	2.4
2	E	267	VAL	2.4
2	G	247	ASP	2.3
2	I	131	GLU	2.3

Continued on next page...

Continued from previous page...

Mol	Chain	Res	Type	RSRZ
2	E	343	THR	2.3
2	E	284	ALA	2.3
2	G	290	TYR	2.3
2	B	304	GLY	2.3
2	E	331	LEU	2.3
2	I	332	LEU	2.3
2	I	272	GLY	2.2
1	D	288	GLY	2.2
2	E	132	ARG	2.2
1	F	263	ARG	2.2
2	G	369	VAL	2.2
2	E	357	VAL	2.1
2	E	345	GLU	2.1
2	B	332	LEU	2.1
2	G	55	LYS	2.1
2	G	133	PRO	2.1
2	G	322	GLY	2.1
2	G	319	VAL	2.1
2	E	351	LEU	2.1
2	I	300	PRO	2.1
2	B	123	VAL	2.1
2	E	316	ALA	2.1
2	I	345	GLU	2.1
2	G	326	ALA	2.1
2	E	126	GLU	2.1
2	E	317	ASP	2.1
2	E	359	MET	2.1
2	G	341	ALA	2.1
2	E	124	ASP	2.0
2	E	334	LYS	2.0
2	I	334	LYS	2.0

6.2 Non-standard residues in protein, DNA, RNA chains [i](#)

There are no non-standard protein/DNA/RNA residues in this entry.

6.3 Carbohydrates [i](#)

There are no monosaccharides in this entry.

6.4 Ligands [i](#)

In the following table, the Atoms column lists the number of modelled atoms in the group and the number defined in the chemical component dictionary. The B-factors column lists the minimum, median, 95th percentile and maximum values of B factors of atoms in the group. The column labelled 'Q< 0.9' lists the number of atoms with occupancy less than 0.9.

Mol	Type	Chain	Res	Atoms	RSCC	RSR	B-factors(Å ²)	Q<0.9
3	GDP	B	398	28/28	0.88	0.22	33,52,60,64	28
3	GDP	G	398	28/28	0.90	0.19	34,48,59,59	28
4	MN	B	399	1/1	0.91	0.09	55,55,55,55	1
3	GDP	I	398	28/28	0.92	0.14	33,42,50,58	28
4	MN	G	399	1/1	0.93	0.07	55,55,55,55	1
3	GDP	E	398	28/28	0.94	0.13	37,49,58,63	28
4	MN	E	399	1/1	0.96	0.26	55,55,55,55	1
4	MN	I	399	1/1	0.98	0.15	51,51,51,51	1

The following is a graphical depiction of the model fit to experimental electron density of all instances of the Ligand of Interest. In addition, ligands with molecular weight > 250 and outliers as shown on the geometry validation Tables will also be included. Each fit is shown from different orientation to approximate a three-dimensional view.

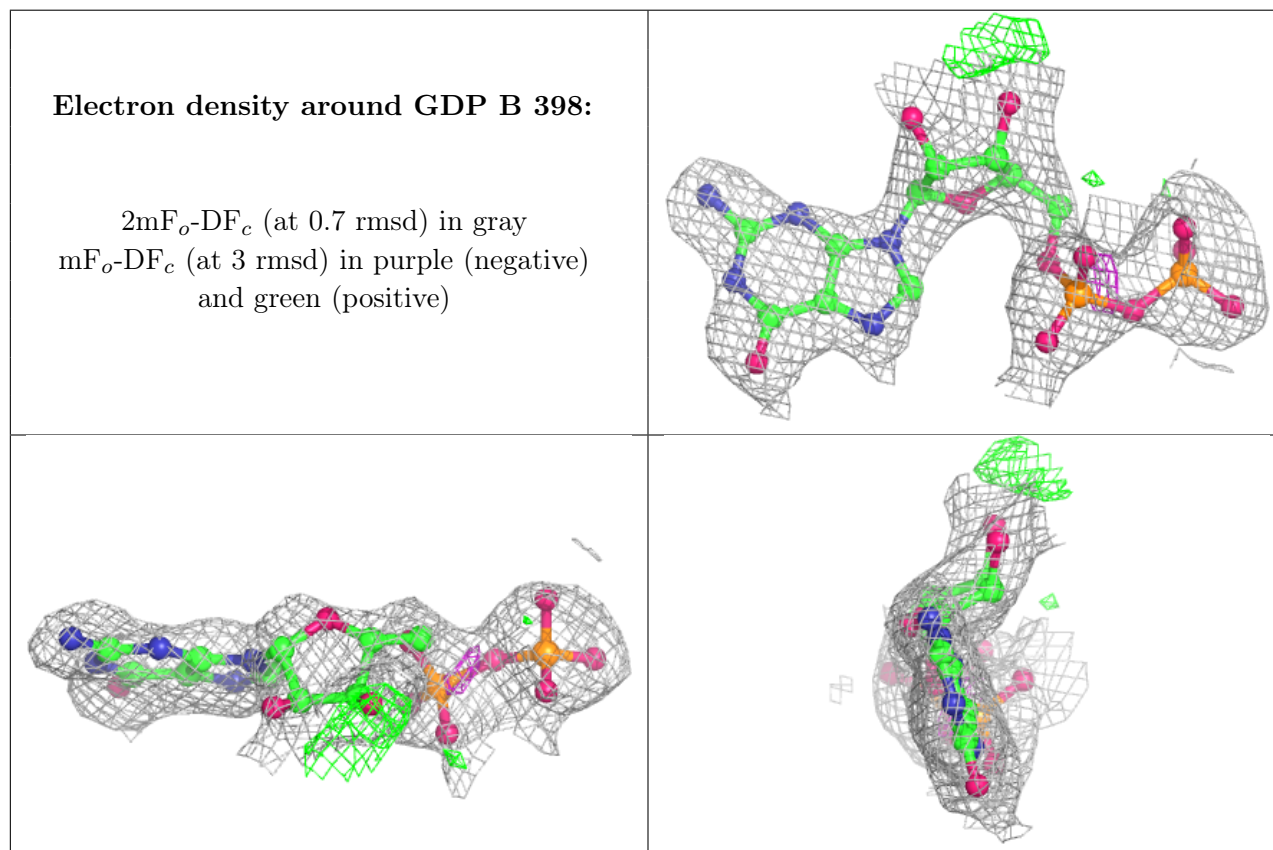

Electron density around GDP G 398:

$2mF_o-DF_c$ (at 0.7 rmsd) in gray
 mF_o-DF_c (at 3 rmsd) in purple (negative)
and green (positive)

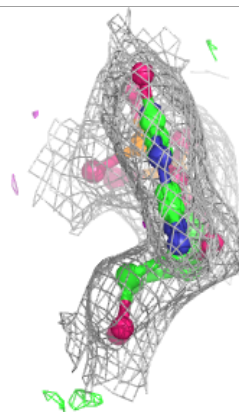
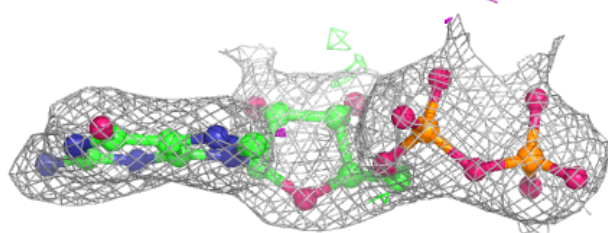
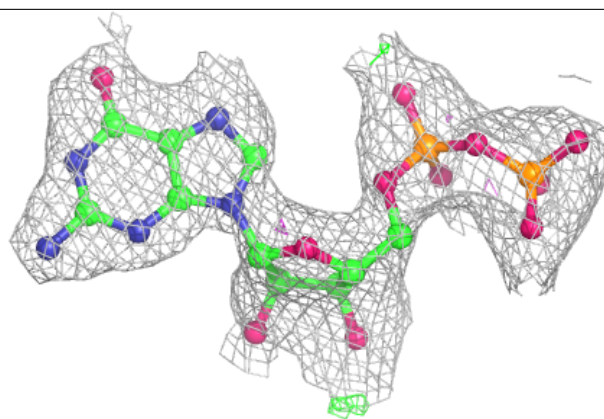
**Electron density around GDP I 398:**

$2mF_o-DF_c$ (at 0.7 rmsd) in gray
 mF_o-DF_c (at 3 rmsd) in purple (negative)
and green (positive)

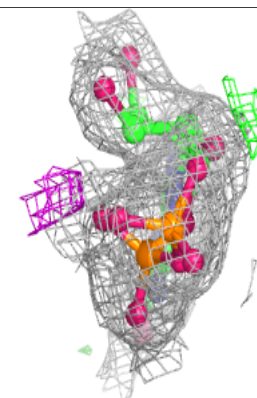
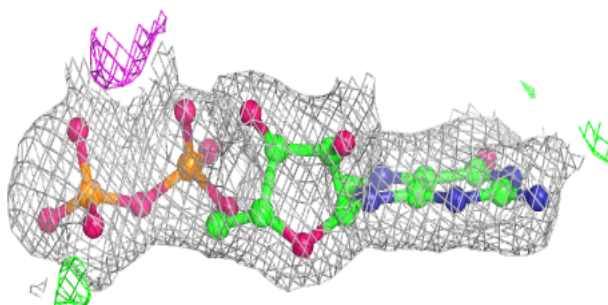
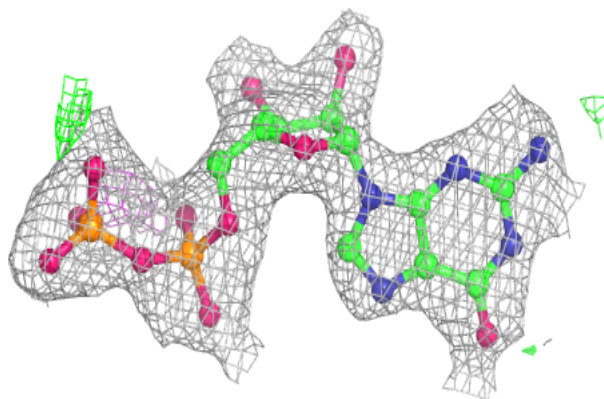

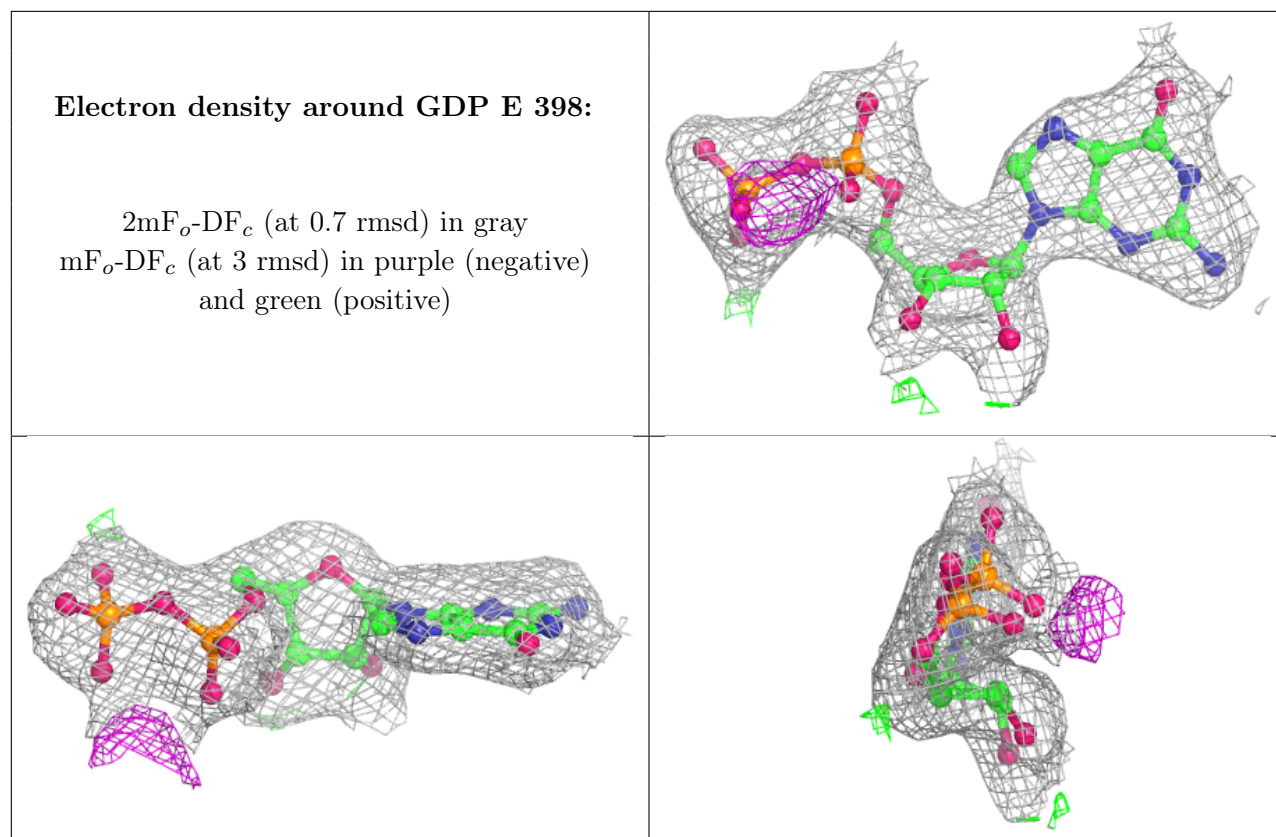

6.5 Other polymers [i](#)

There are no such residues in this entry.