



wwPDB X-ray Structure Validation Summary Report ⓘ

Aug 8, 2020 – 12:31 AM BST

PDB ID : 3K6S
Title : Structure of integrin alphaXbeta2 ectodomain
Authors : Xie, C.; Zhu, J.; Chen, X.; Mi, L.; Nishida, N.; Springer, T.A.
Deposited on : 2009-10-09
Resolution : 3.50 Å(reported)

This is a wwPDB X-ray Structure Validation Summary Report for a publicly released PDB entry.

We welcome your comments at validation@mail.wwpdb.org

A user guide is available at

<https://www.wwpdb.org/validation/2017/XrayValidationReportHelp>

with specific help available everywhere you see the ⓘ symbol.

The following versions of software and data (see [references ⓘ](#)) were used in the production of this report:

MolProbity : 4.02b-467
Mogul : 1.8.5 (274361), CSD as541be (2020)
Xtriage (Phenix) : 1.13
EDS : 2.13.1
Percentile statistics : 20191225.v01 (using entries in the PDB archive December 25th 2019)
Refmac : 5.8.0158
CCP4 : 7.0.044 (Gargrove)
Ideal geometry (proteins) : Engh & Huber (2001)
Ideal geometry (DNA, RNA) : Parkinson et al. (1996)
Validation Pipeline (wwPDB-VP) : 2.13.1

1 Overall quality at a glance

The following experimental techniques were used to determine the structure:

X-RAY DIFFRACTION

The reported resolution of this entry is 3.50 Å.

Percentile scores (ranging between 0-100) for global validation metrics of the entry are shown in the following graphic. The table shows the number of entries on which the scores are based.

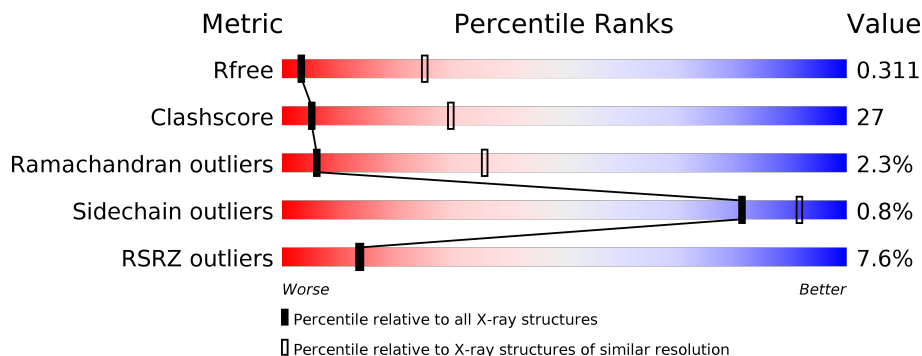

Metric	Whole archive (#Entries)	Similar resolution (#Entries, resolution range(Å))
R_{free}	130704	1659 (3.60-3.40)
Clashscore	141614	1036 (3.58-3.42)
Ramachandran outliers	138981	1005 (3.58-3.42)
Sidechain outliers	138945	1006 (3.58-3.42)
RSRZ outliers	127900	1559 (3.60-3.40)

The table below summarises the geometric issues observed across the polymeric chains and their fit to the electron density. The red, orange, yellow and green segments on the lower bar indicate the fraction of residues that contain outliers for ≥ 3 , 2, 1 and 0 types of geometric quality criteria respectively. A grey segment represents the fraction of residues that are not modelled. The numeric value for each fraction is indicated below the corresponding segment, with a dot representing fractions $\leq 5\%$. The upper red bar (where present) indicates the fraction of residues that have poor fit to the electron density. The numeric value is given above the bar.

Mol	Chain	Length	Quality of chain
1	A	1095	
1	C	1095	
1	E	1095	
1	G	1095	
2	B	687	
2	D	687	

Continued on next page...

Continued from previous page...

Mol	Chain	Length	Quality of chain
2	F	687	
2	H	687	
3	I	2	
3	K	2	
3	L	2	
3	M	2	
3	N	2	
3	O	2	
3	Q	2	
3	R	2	
3	T	2	
4	J	5	
5	P	3	
5	S	3	

The following table lists non-polymeric compounds, carbohydrate monomers and non-standard residues in protein, DNA, RNA chains that are outliers for geometric or electron-density-fit criteria:

Mol	Type	Chain	Res	Chirality	Geometry	Clashes	Electron density
3	NAG	L	2	-	-	-	X
3	NAG	M	1	X	-	-	X
3	NAG	M	2	-	-	-	X
3	NAG	N	2	-	-	-	X
3	NAG	O	2	-	-	-	X
4	NAG	J	1	X	-	-	-
4	MAN	J	3	X	-	-	-
5	NAG	P	1	X	-	-	-
5	MAN	P	3	X	-	-	-
5	NAG	S	1	X	-	-	-
5	NAG	S	2	-	-	-	X
5	MAN	S	3	X	-	-	-
7	NAG	C	3678	-	-	-	X

Continued on next page...

Continued from previous page...

Mol	Type	Chain	Res	Chirality	Geometry	Clashes	Electron density
7	NAG	D	3094	-	-	-	X

2 Entry composition i

There are 10 unique types of molecules in this entry. The entry contains 50187 atoms, of which 0 are hydrogens and 0 are deuteriums.

In the tables below, the ZeroOcc column contains the number of atoms modelled with zero occupancy, the AltConf column contains the number of residues with at least one atom in alternate conformation and the Trace column contains the number of residues modelled with at most 2 atoms.

- Molecule 1 is a protein called Integrin alpha-X.

Mol	Chain	Residues	Atoms					ZeroOcc	AltConf	Trace
			Total	C	N	O	S			
1	A	1082	8392	5304	1454	1596	38	0	0	0
1	C	885	6825	4311	1182	1298	34	0	0	0
1	E	884	6819	4308	1181	1296	34	0	0	0
1	G	885	6825	4311	1182	1298	34	0	0	0

There are 44 discrepancies between the modelled and reference sequences:

Chain	Residue	Modelled	Actual	Comment	Reference
A	1085	GLY	-	expression tag	UNP P20702
A	1086	CYS	-	expression tag	UNP P20702
A	1087	GLY	-	expression tag	UNP P20702
A	1088	GLY	-	expression tag	UNP P20702
A	1089	LEU	-	expression tag	UNP P20702
A	1090	GLU	-	expression tag	UNP P20702
A	1091	ASN	-	expression tag	UNP P20702
A	1092	LEU	-	expression tag	UNP P20702
A	1093	TYR	-	expression tag	UNP P20702
A	1094	PHE	-	expression tag	UNP P20702
A	1095	GLN	-	expression tag	UNP P20702
C	1085	GLY	-	expression tag	UNP P20702
C	1086	CYS	-	expression tag	UNP P20702
C	1087	GLY	-	expression tag	UNP P20702
C	1088	GLY	-	expression tag	UNP P20702
C	1089	LEU	-	expression tag	UNP P20702
C	1090	GLU	-	expression tag	UNP P20702
C	1091	ASN	-	expression tag	UNP P20702
C	1092	LEU	-	expression tag	UNP P20702
C	1093	TYR	-	expression tag	UNP P20702
C	1094	PHE	-	expression tag	UNP P20702

Continued on next page...

Continued from previous page...

Chain	Residue	Modelled	Actual	Comment	Reference
C	1095	GLN	-	expression tag	UNP P20702
E	1085	GLY	-	expression tag	UNP P20702
E	1086	CYS	-	expression tag	UNP P20702
E	1087	GLY	-	expression tag	UNP P20702
E	1088	GLY	-	expression tag	UNP P20702
E	1089	LEU	-	expression tag	UNP P20702
E	1090	GLU	-	expression tag	UNP P20702
E	1091	ASN	-	expression tag	UNP P20702
E	1092	LEU	-	expression tag	UNP P20702
E	1093	TYR	-	expression tag	UNP P20702
E	1094	PHE	-	expression tag	UNP P20702
E	1095	GLN	-	expression tag	UNP P20702
G	1085	GLY	-	expression tag	UNP P20702
G	1086	CYS	-	expression tag	UNP P20702
G	1087	GLY	-	expression tag	UNP P20702
G	1088	GLY	-	expression tag	UNP P20702
G	1089	LEU	-	expression tag	UNP P20702
G	1090	GLU	-	expression tag	UNP P20702
G	1091	ASN	-	expression tag	UNP P20702
G	1092	LEU	-	expression tag	UNP P20702
G	1093	TYR	-	expression tag	UNP P20702
G	1094	PHE	-	expression tag	UNP P20702
G	1095	GLN	-	expression tag	UNP P20702

- Molecule 2 is a protein called Integrin beta-2.

Mol	Chain	Residues	Atoms					ZeroOcc	AltConf	Trace
			Total	C	N	O	S			
2	B	674	5184	3186	930	1004	64	0	0	0
2	D	674	5184	3186	930	1004	64	0	0	0
2	F	674	5184	3186	930	1004	64	0	0	0
2	H	674	5184	3186	930	1004	64	0	0	0

There are 36 discrepancies between the modelled and reference sequences:

Chain	Residue	Modelled	Actual	Comment	Reference
B	678	ASP	-	expression tag	UNP P05107
B	679	GLY	-	expression tag	UNP P05107
B	680	CYS	-	expression tag	UNP P05107

Continued on next page...

Continued from previous page...

Chain	Residue	Modelled	Actual	Comment	Reference
B	681	GLY	-	expression tag	UNP P05107
B	682	GLU	-	expression tag	UNP P05107
B	684	LEU	-	expression tag	UNP P05107
B	685	TYR	-	expression tag	UNP P05107
B	686	PHE	-	expression tag	UNP P05107
B	687	GLN	-	expression tag	UNP P05107
D	678	ASP	-	expression tag	UNP P05107
D	679	GLY	-	expression tag	UNP P05107
D	680	CYS	-	expression tag	UNP P05107
D	681	GLY	-	expression tag	UNP P05107
D	682	GLU	-	expression tag	UNP P05107
D	684	LEU	-	expression tag	UNP P05107
D	685	TYR	-	expression tag	UNP P05107
D	686	PHE	-	expression tag	UNP P05107
D	687	GLN	-	expression tag	UNP P05107
F	678	ASP	-	expression tag	UNP P05107
F	679	GLY	-	expression tag	UNP P05107
F	680	CYS	-	expression tag	UNP P05107
F	681	GLY	-	expression tag	UNP P05107
F	682	GLU	-	expression tag	UNP P05107
F	684	LEU	-	expression tag	UNP P05107
F	685	TYR	-	expression tag	UNP P05107
F	686	PHE	-	expression tag	UNP P05107
F	687	GLN	-	expression tag	UNP P05107
H	678	ASP	-	expression tag	UNP P05107
H	679	GLY	-	expression tag	UNP P05107
H	680	CYS	-	expression tag	UNP P05107
H	681	GLY	-	expression tag	UNP P05107
H	682	GLU	-	expression tag	UNP P05107
H	684	LEU	-	expression tag	UNP P05107
H	685	TYR	-	expression tag	UNP P05107
H	686	PHE	-	expression tag	UNP P05107
H	687	GLN	-	expression tag	UNP P05107

- Molecule 3 is an oligosaccharide called 2-acetamido-2-deoxy-beta-D-glucopyranose-(1-4)-2-acetamido-2-deoxy-beta-D-glucopyranose.



Mol	Chain	Residues	Atoms				ZeroOcc	AltConf	Trace
3	I	2	Total	C	N	O	0	0	0
			28	16	2	10			
3	K	2	Total	C	N	O	0	0	0
			28	16	2	10			
3	L	2	Total	C	N	O	0	0	0
			28	16	2	10			
3	M	2	Total	C	N	O	0	0	0
			28	16	2	10			
3	N	2	Total	C	N	O	0	0	0
			28	16	2	10			
3	O	2	Total	C	N	O	0	0	0
			28	16	2	10			
3	Q	2	Total	C	N	O	0	0	0
			28	16	2	10			
3	R	2	Total	C	N	O	0	0	0
			28	16	2	10			
3	T	2	Total	C	N	O	0	0	0
			28	16	2	10			

- Molecule 4 is an oligosaccharide called alpha-D-mannopyranose-(1-3)-[alpha-D-mannopyranose-(1-6)]alpha-D-mannopyranose-(1-4)-2-acetamido-2-deoxy-beta-D-glucopyranose-(1-4)-2-acetamido-2-deoxy-beta-D-glucopyranose.

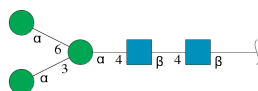

Mol	Chain	Residues	Atoms				ZeroOcc	AltConf	Trace
4	J	5	Total	C	N	O	0	0	0
			61	34	2	25			

- Molecule 5 is an oligosaccharide called alpha-D-mannopyranose-(1-4)-2-acetamido-2-deoxy-beta-D-glucopyranose-(1-4)-2-acetamido-2-deoxy-beta-D-glucopyranose.



Mol	Chain	Residues	Atoms				ZeroOcc	AltConf	Trace
5	P	3	Total	C	N	O	0	0	0
			39	22	2	15			
5	S	3	Total	C	N	O	0	0	0
			39	22	2	15			

- Molecule 6 is alpha-D-mannopyranose (three-letter code: MAN) (formula: $C_6H_{12}O_6$).

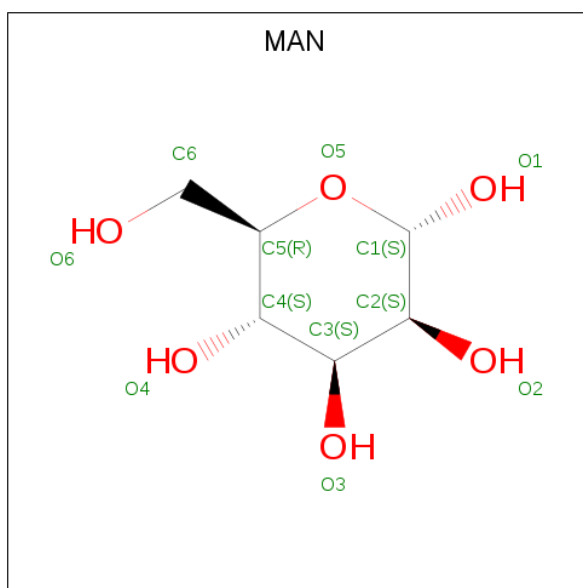

Mol	Chain	Residues	Atoms			ZeroOcc	AltConf
6	A	1	Total	C	O	0	0
			11	6	5		

- Molecule 7 is 2-acetamido-2-deoxy-beta-D-glucopyranose (three-letter code: NAG) (formula: $C_8H_{15}NO_6$).

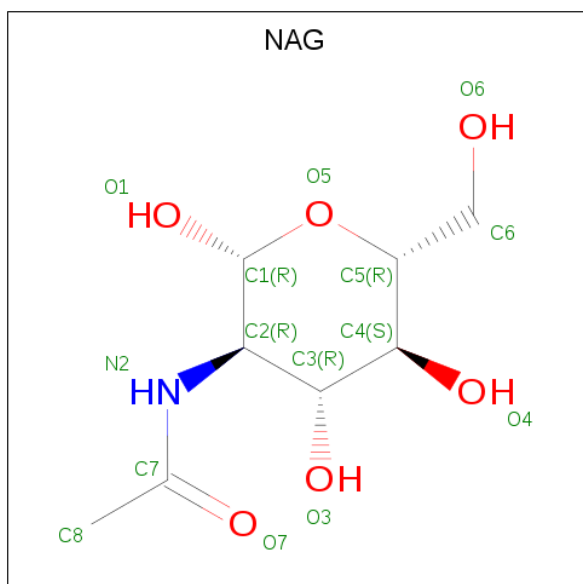

Mol	Chain	Residues	Atoms				ZeroOcc	AltConf
7	A	1	Total	C	N	O	0	0
			14	8	1	5		

Continued on next page...

Continued from previous page...

Mol	Chain	Residues	Atoms				ZeroOcc	AltConf
7	A	1	Total	C	N	O	0	0
			14	8	1	5		
7	B	1	Total	C	N	O	0	0
			14	8	1	5		
7	C	1	Total	C	N	O	0	0
			14	8	1	5		
7	C	1	Total	C	N	O	0	0
			14	8	1	5		
7	D	1	Total	C	N	O	0	0
			14	8	1	5		
7	E	1	Total	C	N	O	0	0
			14	8	1	5		
7	E	1	Total	C	N	O	0	0
			14	8	1	5		
7	F	1	Total	C	N	O	0	0
			14	8	1	5		
7	G	1	Total	C	N	O	0	0
			14	8	1	5		
7	G	1	Total	C	N	O	0	0
			14	8	1	5		
7	H	1	Total	C	N	O	0	0
			14	8	1	5		

- Molecule 8 is CALCIUM ION (three-letter code: CA) (formula: Ca).

Mol	Chain	Residues	Atoms		ZeroOcc	AltConf
8	G	3	Total	Ca	0	0
			3	3		
8	D	1	Total	Ca	0	0
			1	1		
8	E	3	Total	Ca	0	0
			3	3		
8	H	1	Total	Ca	0	0
			1	1		
8	B	1	Total	Ca	0	0
			1	1		
8	C	3	Total	Ca	0	0
			3	3		
8	A	3	Total	Ca	0	0
			3	3		
8	F	1	Total	Ca	0	0
			1	1		

- Molecule 9 is MAGNESIUM ION (three-letter code: MG) (formula: Mg).

Mol	Chain	Residues	Atoms		ZeroOcc	AltConf
9	A	1	Total 1	Mg 1	0	0

- Molecule 10 is water.

Mol	Chain	Residues	Atoms		ZeroOcc	AltConf
10	A	3	Total 3	O 3	0	0

3 Residue-property plots

These plots are drawn for all protein, RNA, DNA and oligosaccharide chains in the entry. The first graphic for a chain summarises the proportions of the various outlier classes displayed in the second graphic. The second graphic shows the sequence view annotated by issues in geometry and electron density. Residues are color-coded according to the number of geometric quality criteria for which they contain at least one outlier: green = 0, yellow = 1, orange = 2 and red = 3 or more. A red dot above a residue indicates a poor fit to the electron density ($RSRZ > 2$). Stretches of 2 or more consecutive residues without any outlier are shown as a green connector. Residues present in the sample, but not in the model, are shown in grey.

- Molecule 1: Integrin alpha-X

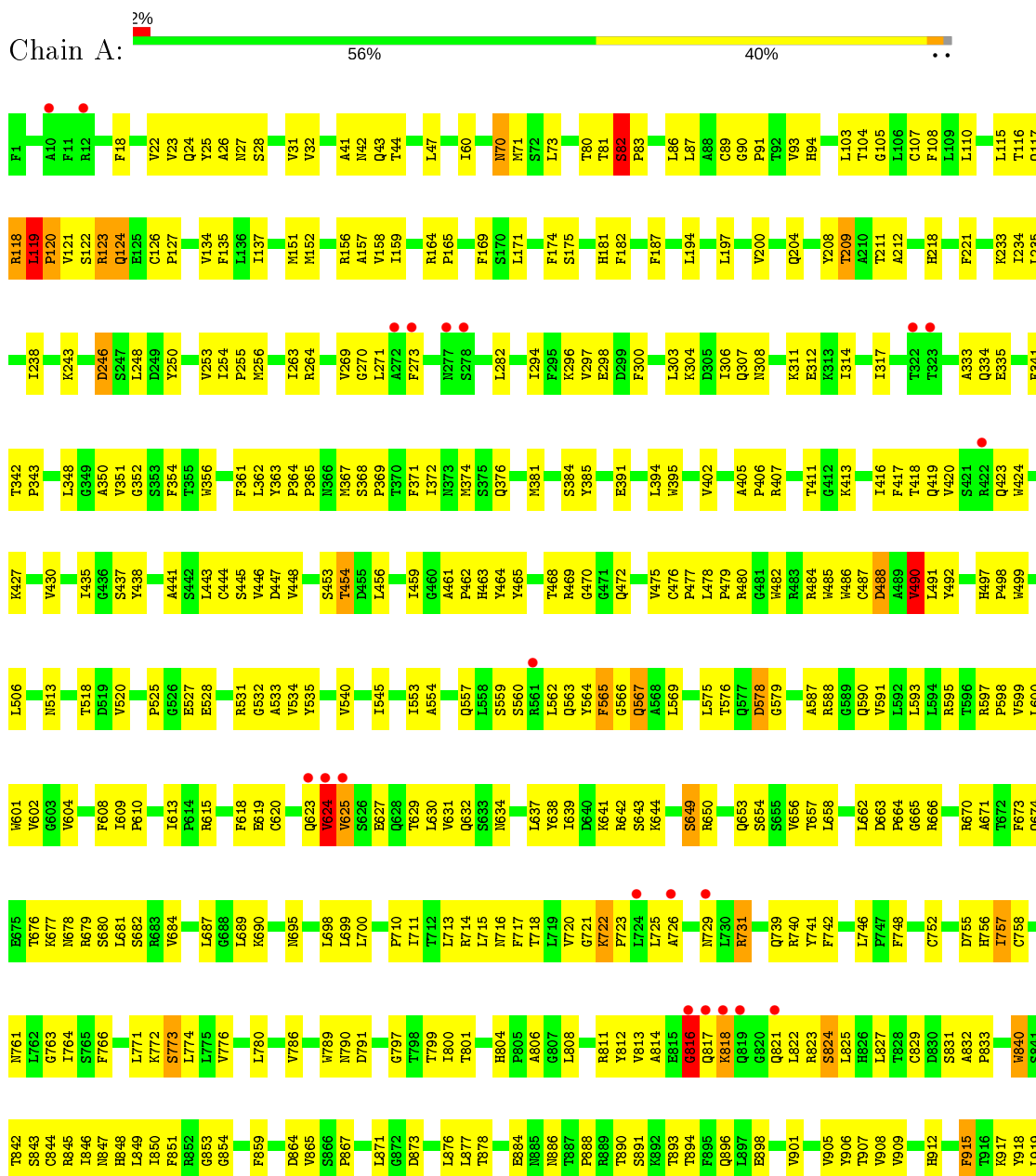

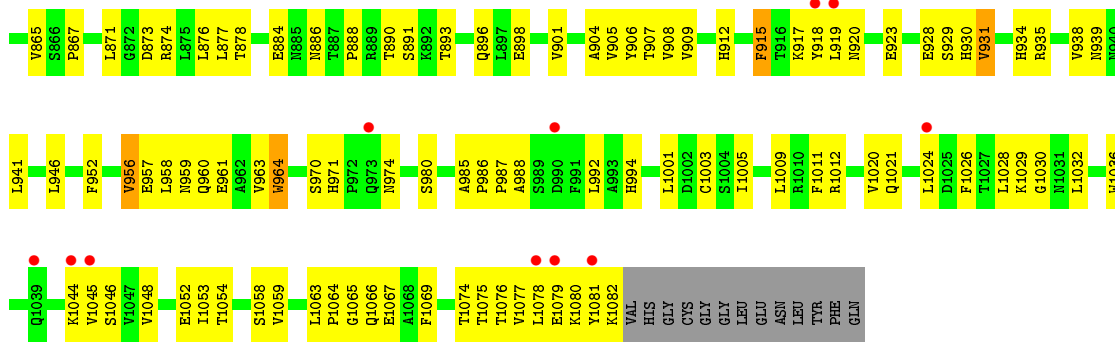

• Molecule 1: Integrin alpha-X

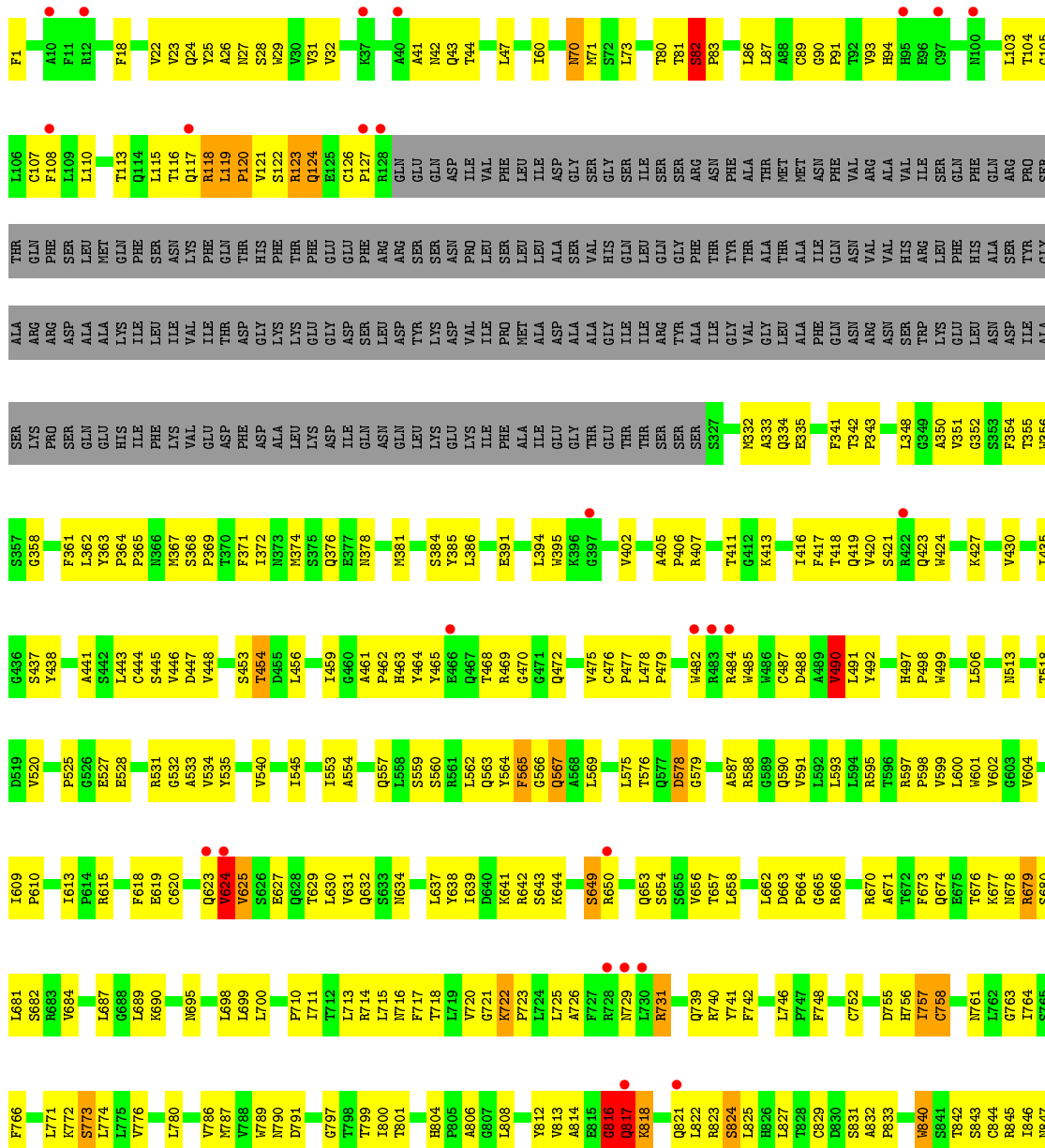
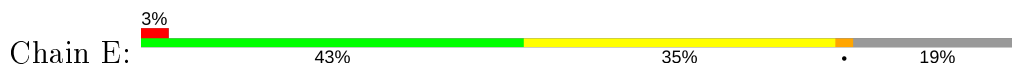

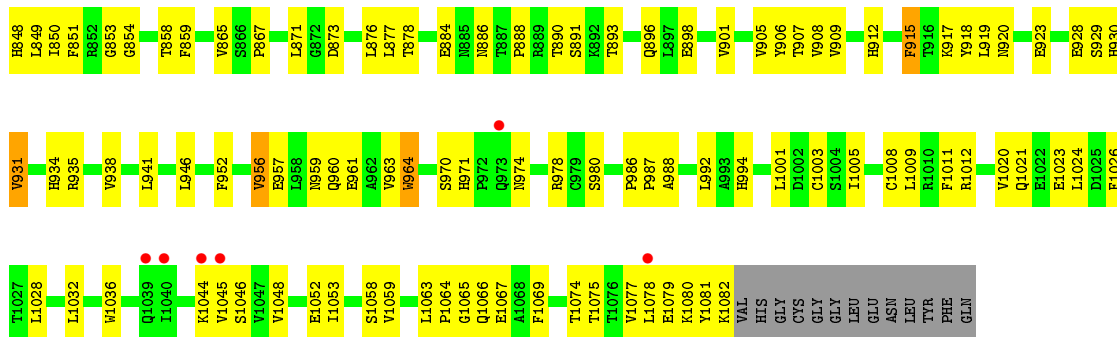

• Molecule 1: Integrin alpha-X

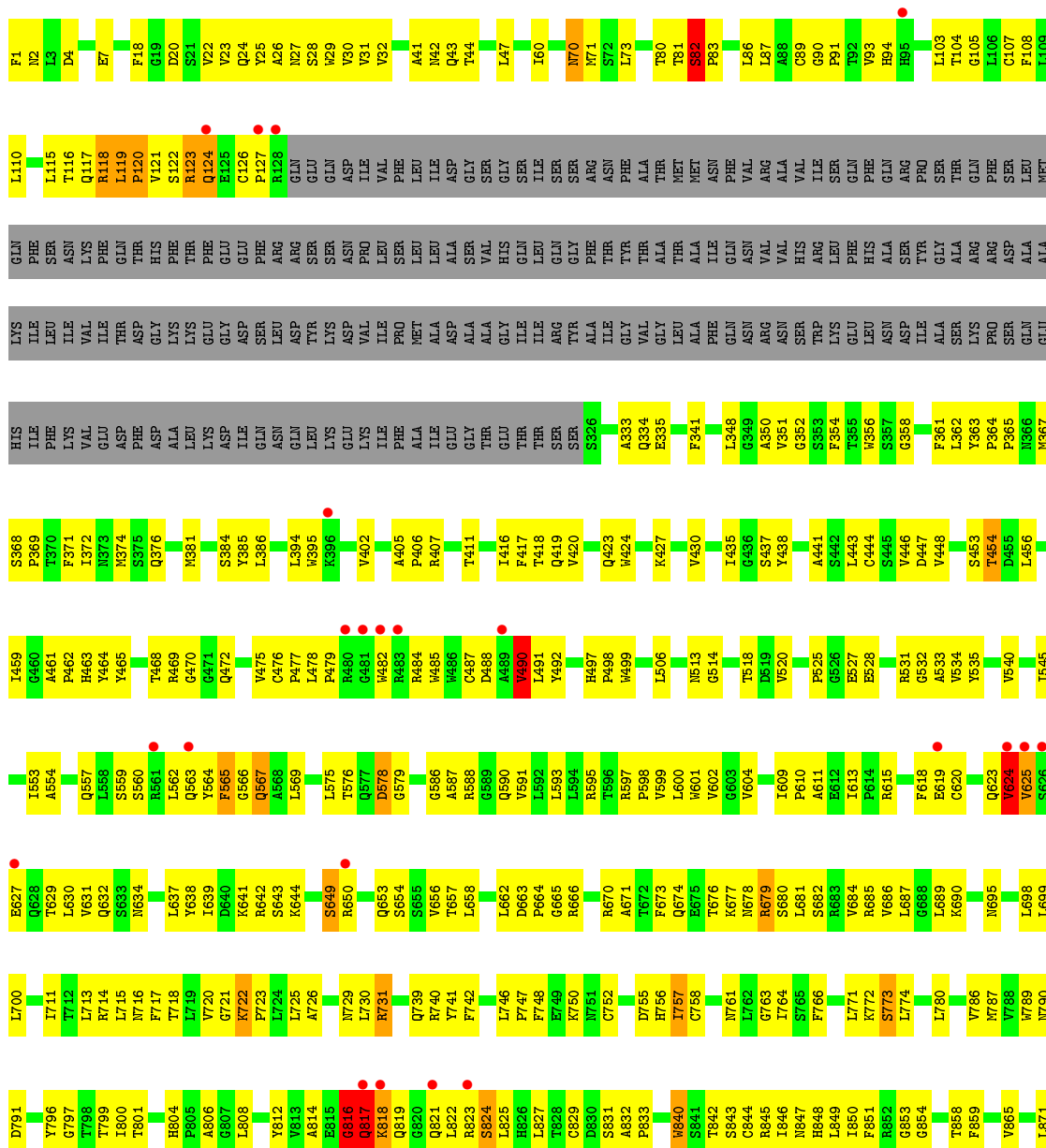

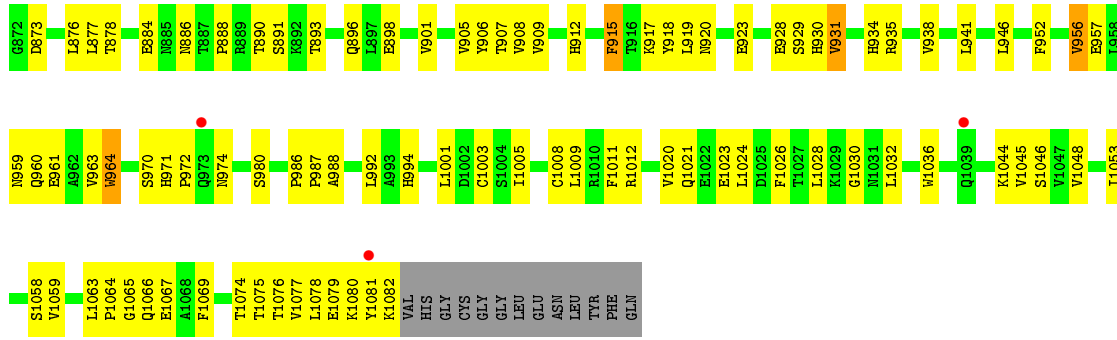

• Molecule 2: Integrin beta-2

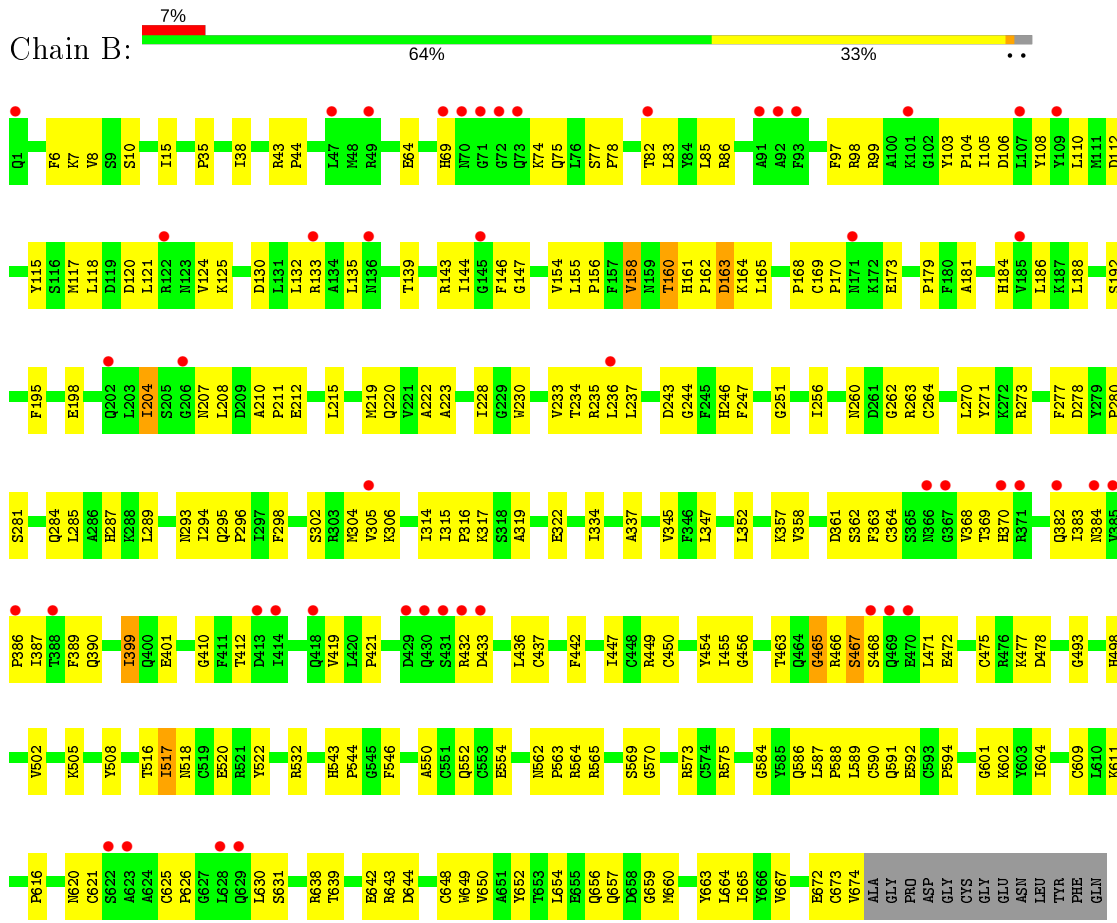

• Molecule 2: Integrin beta-2

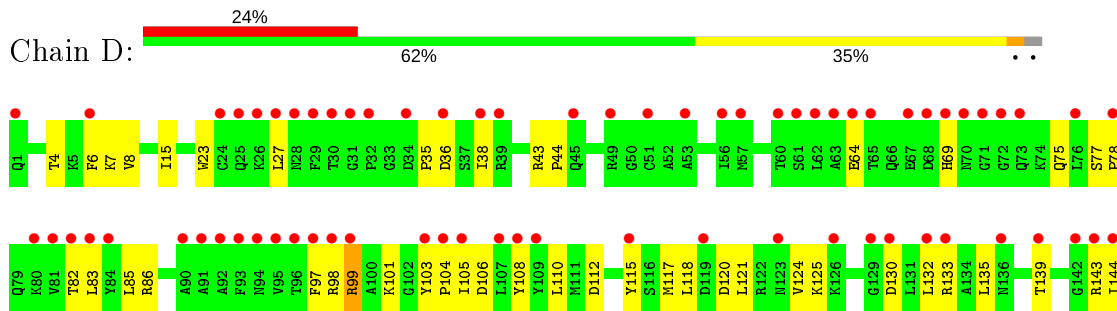

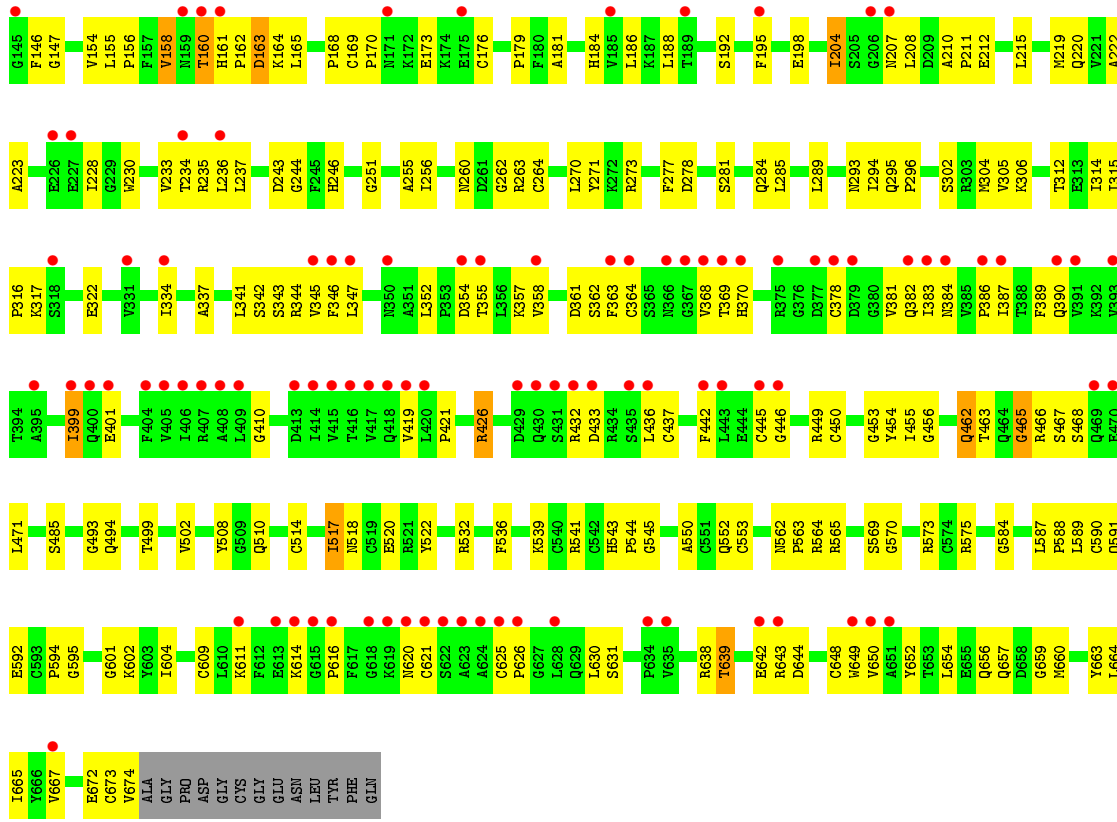

• Molecule 2: Integrin beta-2

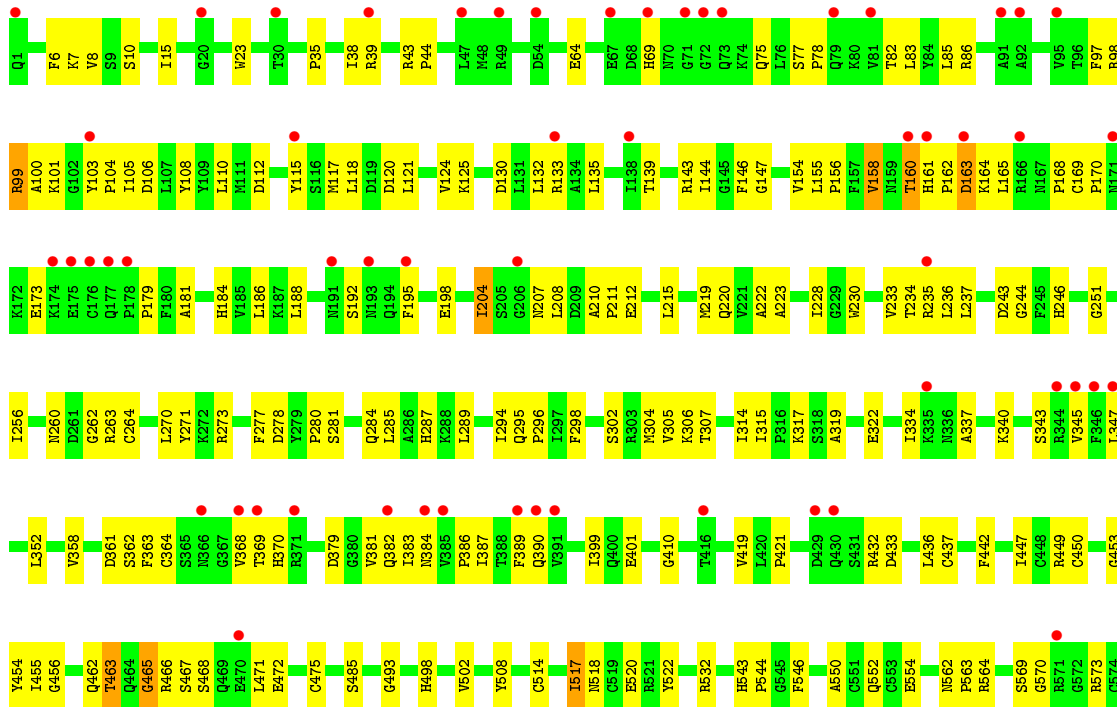

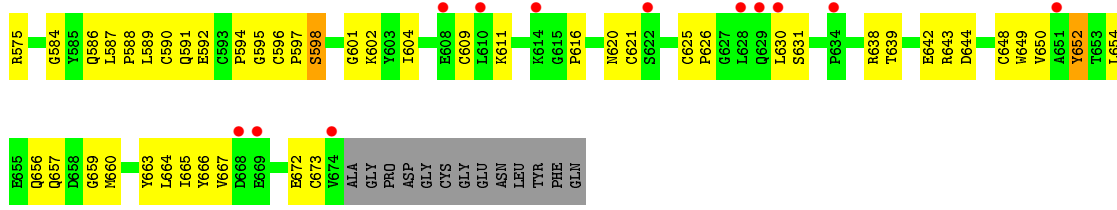

• Molecule 2: Integrin beta-2

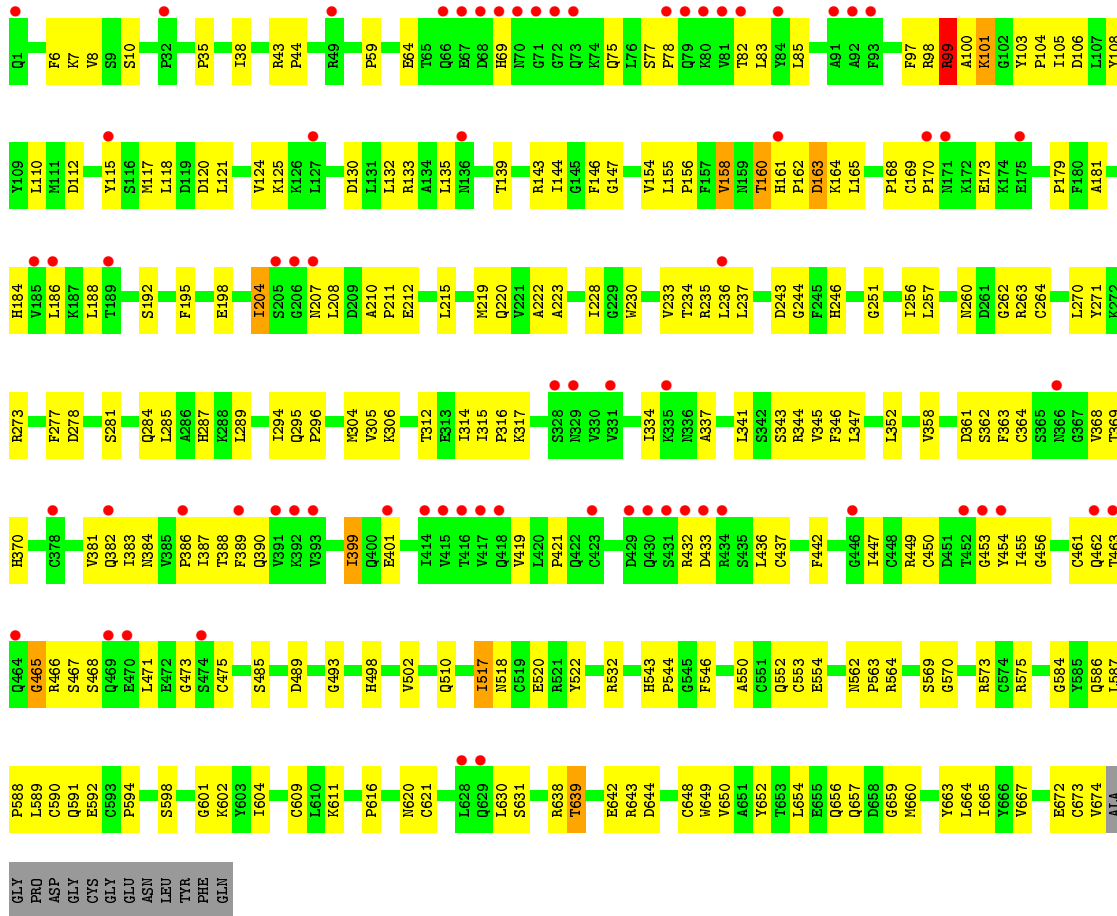

• Molecule 3: 2-acetamido-2-deoxy-beta-D-glucopyranose-(1-4)-2-acetamido-2-deoxy-beta-D-glucopyranose



• Molecule 3: 2-acetamido-2-deoxy-beta-D-glucopyranose-(1-4)-2-acetamido-2-deoxy-beta-D-glucopyranose



MAG1
MAG2

- Molecule 3: 2-acetamido-2-deoxy-beta-D-glucopyranose-(1-4)-2-acetamido-2-deoxy-beta-D-glucopyranose

Chain L:  50% 50%MAG1
MAG2

- Molecule 3: 2-acetamido-2-deoxy-beta-D-glucopyranose-(1-4)-2-acetamido-2-deoxy-beta-D-glucopyranose

Chain M:  100%MAG1
MAG2

- Molecule 3: 2-acetamido-2-deoxy-beta-D-glucopyranose-(1-4)-2-acetamido-2-deoxy-beta-D-glucopyranose

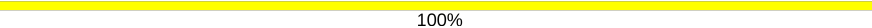
Chain N:  100%MAG1
MAG2

- Molecule 3: 2-acetamido-2-deoxy-beta-D-glucopyranose-(1-4)-2-acetamido-2-deoxy-beta-D-glucopyranose

Chain O:  50% 50%MAG1
MAG2

- Molecule 3: 2-acetamido-2-deoxy-beta-D-glucopyranose-(1-4)-2-acetamido-2-deoxy-beta-D-glucopyranose

Chain Q:  100%MAG1
MAG2

- Molecule 3: 2-acetamido-2-deoxy-beta-D-glucopyranose-(1-4)-2-acetamido-2-deoxy-beta-D-glucopyranose

Chain R:  50% 50%MAG1
MAG2

- Molecule 3: 2-acetamido-2-deoxy-beta-D-glucopyranose-(1-4)-2-acetamido-2-deoxy-beta-D-glucopyranose

Chain T:  100%

MAG1
MAG2

- Molecule 4: alpha-D-mannopyranose-(1-3)-[alpha-D-mannopyranose-(1-6)]alpha-D-mannopyranose-(1-4)-2-acetamido-2-deoxy-beta-D-glucopyranose-(1-4)-2-acetamido-2-deoxy-beta-D-glucopyranose

Chain J:  20%  80%

MAG1
MAG2
MAN3
MAN4
MAN5

- Molecule 5: alpha-D-mannopyranose-(1-4)-2-acetamido-2-deoxy-beta-D-glucopyranose-(1-4)-2-acetamido-2-deoxy-beta-D-glucopyranose

Chain P:  100%

MAG1
MAG2
MAN3

- Molecule 5: alpha-D-mannopyranose-(1-4)-2-acetamido-2-deoxy-beta-D-glucopyranose-(1-4)-2-acetamido-2-deoxy-beta-D-glucopyranose

Chain S:  100%

MAG1
MAG2
MAN3

4 Data and refinement statistics

Property	Value	Source
Space group	P 21 21 21	Depositor
Cell constants a, b, c, α , β , γ	132.09Å 163.56Å 536.91Å 90.00° 90.00° 90.00°	Depositor
Resolution (Å)	48.61 – 3.50 48.61 – 3.50	Depositor EDS
% Data completeness (in resolution range)	100.0 (48.61-3.50) 100.0 (48.61-3.50)	Depositor EDS
R_{merge}	0.16	Depositor
R_{sym}	0.16	Depositor
$\langle I/\sigma(I) \rangle$ ¹	1.96 (at 3.48Å)	Xtrriage
Refinement program	PHENIX (phenix.refine)	Depositor
R, R_{free}	0.297 , 0.335 0.280 , 0.311	Depositor DCC
R_{free} test set	1536 reflections (1.04%)	wwPDB-VP
Wilson B-factor (Å ²)	80.7	Xtrriage
Anisotropy	0.176	Xtrriage
Bulk solvent k_{sol} (e/Å ³), B_{sol} (Å ²)	0.30 , 177.6	EDS
L-test for twinning ²	$\langle L \rangle = 0.41$, $\langle L^2 \rangle = 0.23$	Xtrriage
Estimated twinning fraction	No twinning to report.	Xtrriage
F_o, F_c correlation	0.86	EDS
Total number of atoms	50187	wwPDB-VP
Average B, all atoms (Å ²)	189.0	wwPDB-VP

Xtrriage's analysis on translational NCS is as follows: *The largest off-origin peak in the Patterson function is 2.60% of the height of the origin peak. No significant pseudotranslation is detected.*

¹Intensities estimated from amplitudes.

²Theoretical values of $\langle |L| \rangle$, $\langle L^2 \rangle$ for acentric reflections are 0.5, 0.333 respectively for untwinned datasets, and 0.375, 0.2 for perfectly twinned datasets.

5 Model quality [i](#)

5.1 Standard geometry [i](#)

Bond lengths and bond angles in the following residue types are not validated in this section: MG, MAN, CA, NAG

The Z score for a bond length (or angle) is the number of standard deviations the observed value is removed from the expected value. A bond length (or angle) with $|Z| > 5$ is considered an outlier worth inspection. RMSZ is the root-mean-square of all Z scores of the bond lengths (or angles).

Mol	Chain	Bond lengths		Bond angles	
		RMSZ	# Z >5	RMSZ	# Z >5
1	A	0.23	0/8579	0.44	1/11652 (0.0%)
1	C	0.24	0/6980	0.46	0/9494
1	E	0.23	0/6974	0.45	0/9486
1	G	0.24	0/6980	0.45	0/9494
2	B	0.22	0/5280	0.41	0/7129
2	D	0.24	0/5280	0.43	0/7129
2	F	0.23	0/5280	0.42	0/7129
2	H	0.23	0/5280	0.42	0/7129
All	All	0.23	0/50633	0.44	1/68642 (0.0%)

Chiral center outliers are detected by calculating the chiral volume of a chiral center and verifying if the center is modelled as a planar moiety or with the opposite hand. A planarity outlier is detected by checking planarity of atoms in a peptide group, atoms in a mainchain group or atoms of a sidechain that are expected to be planar.

Mol	Chain	#Chirality outliers	#Planarity outliers
1	A	0	10
1	C	0	11
1	E	0	10
1	G	0	11
2	B	0	2
2	D	0	3
2	F	0	2
2	H	0	3
All	All	0	52

There are no bond length outliers.

All (1) bond angle outliers are listed below:

Mol	Chain	Res	Type	Atoms	Z	Observed(°)	Ideal(°)
1	A	119	LEU	C-N-CD	-5.77	107.90	120.60

There are no chirality outliers.

5 of 52 planarity outliers are listed below:

Mol	Chain	Res	Type	Group
1	A	118	ARG	Peptide
1	A	119	LEU	Peptide
1	A	488	ASP	Peptide
1	A	490	VAL	Peptide
1	A	82	SER	Peptide

5.2 Too-close contacts [i](#)

In the following table, the Non-H and H(model) columns list the number of non-hydrogen atoms and hydrogen atoms in the chain respectively. The H(added) column lists the number of hydrogen atoms added and optimized by MolProbity. The Clashes column lists the number of clashes within the asymmetric unit, whereas Symm-Clashes lists symmetry related clashes.

Mol	Chain	Non-H	H(model)	H(added)	Clashes	Symm-Clashes
1	A	8392	0	8227	495	0
1	C	6825	0	6685	457	0
1	E	6819	0	6680	428	0
1	G	6825	0	6685	438	0
2	B	5184	0	4975	218	0
2	D	5184	0	4975	255	0
2	F	5184	0	4975	228	0
2	H	5184	0	4975	216	0
3	I	28	0	25	0	0
3	K	28	0	25	0	0
3	L	28	0	25	0	0
3	M	28	0	25	4	0
3	N	28	0	25	0	0
3	O	28	0	25	0	0
3	Q	28	0	25	1	0
3	R	28	0	25	0	0
3	T	28	0	25	1	0
4	J	61	0	52	10	0
5	P	39	0	34	6	0
5	S	39	0	34	7	0
6	A	11	0	10	4	0
7	A	28	0	25	0	0

Continued on next page...

Continued from previous page...

Mol	Chain	Non-H	H(model)	H(added)	Clashes	Symm-Clashes
7	B	14	0	13	0	0
7	C	28	0	25	1	0
7	D	14	0	13	0	0
7	E	28	0	25	0	0
7	F	14	0	13	0	0
7	G	28	0	24	1	0
7	H	14	0	13	0	0
8	A	3	0	0	0	0
8	B	1	0	0	0	0
8	C	3	0	0	0	0
8	D	1	0	0	0	0
8	E	3	0	0	0	0
8	F	1	0	0	0	0
8	G	3	0	0	0	0
8	H	1	0	0	0	0
9	A	1	0	0	0	0
10	A	3	0	0	0	0
All	All	50187	0	48683	2634	0

The all-atom clashscore is defined as the number of clashes found per 1000 atoms (including hydrogen atoms). The all-atom clashscore for this structure is 27.

The worst 5 of 2634 close contacts within the same asymmetric unit are listed below, sorted by their clash magnitude.

Atom-1	Atom-2	Interatomic distance (Å)	Clash overlap (Å)
1:A:985:ALA:CB	1:C:621:ARG:HB2	1.81	1.11
1:A:985:ALA:HB2	1:C:621:ARG:CB	1.90	1.01
1:A:985:ALA:HB2	1:C:621:ARG:CD	1.91	1.00
1:C:484:ARG:NH2	1:C:1021:GLN:HA	1.81	0.95
1:A:985:ALA:HB2	1:C:621:ARG:HB2	1.42	0.94

There are no symmetry-related clashes.

5.3 Torsion angles [i](#)

5.3.1 Protein backbone [i](#)

In the following table, the Percentiles column shows the percent Ramachandran outliers of the chain as a percentile score with respect to all X-ray entries followed by that with respect to entries of similar resolution.

The Analysed column shows the number of residues for which the backbone conformation was analysed, and the total number of residues.

Mol	Chain	Analysed	Favoured	Allowed	Outliers	Percentiles	
1	A	1080/1095 (99%)	839 (78%)	215 (20%)	26 (2%)	6	35
1	C	881/1095 (80%)	663 (75%)	194 (22%)	24 (3%)	5	33
1	E	880/1095 (80%)	665 (76%)	190 (22%)	25 (3%)	5	32
1	G	881/1095 (80%)	666 (76%)	191 (22%)	24 (3%)	5	33
2	B	672/687 (98%)	514 (76%)	147 (22%)	11 (2%)	9	43
2	D	672/687 (98%)	515 (77%)	145 (22%)	12 (2%)	8	41
2	F	672/687 (98%)	514 (76%)	145 (22%)	13 (2%)	8	40
2	H	672/687 (98%)	512 (76%)	146 (22%)	14 (2%)	7	38
All	All	6410/7128 (90%)	4888 (76%)	1373 (21%)	149 (2%)	6	36

5 of 149 Ramachandran outliers are listed below:

Mol	Chain	Res	Type
1	A	82	SER
1	A	120	PRO
1	A	757	ILE
1	C	82	SER
1	C	757	ILE

5.3.2 Protein sidechains [i](#)

In the following table, the Percentiles column shows the percent sidechain outliers of the chain as a percentile score with respect to all X-ray entries followed by that with respect to entries of similar resolution.

The Analysed column shows the number of residues for which the sidechain conformation was analysed, and the total number of residues.

Mol	Chain	Analysed	Rotameric	Outliers	Percentiles	
1	A	924/934 (99%)	914 (99%)	10 (1%)	73	88
1	C	754/934 (81%)	742 (98%)	12 (2%)	62	83
1	E	753/934 (81%)	743 (99%)	10 (1%)	69	86
1	G	754/934 (81%)	744 (99%)	10 (1%)	69	86
2	B	583/592 (98%)	583 (100%)	0	100	100
2	D	583/592 (98%)	582 (100%)	1 (0%)	93	98

Continued on next page...

Continued from previous page...

Mol	Chain	Analysed	Rotameric	Outliers	Percentiles	
2	F	583/592 (98%)	582 (100%)	1 (0%)	93	98
2	H	583/592 (98%)	581 (100%)	2 (0%)	92	97
All	All	5517/6104 (90%)	5471 (99%)	46 (1%)	81	91

5 of 46 residues with a non-rotameric sidechain are listed below:

Mol	Chain	Res	Type
1	C	915	PHE
1	E	567	GLN
1	G	915	PHE
1	C	964	TRP
1	E	119	LEU

Some sidechains can be flipped to improve hydrogen bonding and reduce clashes. 5 of 31 such sidechains are listed below:

Mol	Chain	Res	Type
2	D	295	GLN
1	E	124	GLN
1	G	886	ASN
2	D	462	GLN
1	E	334	GLN

5.3.3 RNA [i](#)

There are no RNA molecules in this entry.

5.4 Non-standard residues in protein, DNA, RNA chains [i](#)

There are no non-standard protein/DNA/RNA residues in this entry.

5.5 Carbohydrates [i](#)

29 monosaccharides are modelled in this entry.

In the following table, the Counts columns list the number of bonds (or angles) for which Mogul statistics could be retrieved, the number of bonds (or angles) that are observed in the model and the number of bonds (or angles) that are defined in the Chemical Component Dictionary. The Link column lists molecule types, if any, to which the group is linked. The Z score for a bond length (or angle) is the number of standard deviations the observed value is removed from the

expected value. A bond length (or angle) with $|Z| > 2$ is considered an outlier worth inspection. RMSZ is the root-mean-square of all Z scores of the bond lengths (or angles).

Mol	Type	Chain	Res	Link	Bond lengths			Bond angles		
					Counts	RMSZ	# Z > 2	Counts	RMSZ	# Z > 2
3	NAG	I	1	1,3	14,14,15	0.55	0	17,19,21	0.66	0
3	NAG	I	2	3	14,14,15	0.55	0	17,19,21	1.04	1 (5%)
4	NAG	J	1	1,4	14,14,15	0.50	0	17,19,21	1.21	2 (11%)
4	NAG	J	2	4	14,14,15	0.56	0	17,19,21	1.76	3 (17%)
4	MAN	J	3	4	11,11,12	0.45	0	15,15,17	1.99	7 (46%)
4	MAN	J	4	4	11,11,12	0.77	0	15,15,17	1.19	1 (6%)
4	MAN	J	5	4	11,11,12	0.63	0	15,15,17	1.57	2 (13%)
3	NAG	K	1	1,3	14,14,15	0.59	0	17,19,21	1.76	2 (11%)
3	NAG	K	2	3	14,14,15	0.53	0	17,19,21	1.57	1 (5%)
3	NAG	L	1	1,3	14,14,15	0.55	0	17,19,21	0.64	0
3	NAG	L	2	3	14,14,15	0.58	0	17,19,21	1.00	1 (5%)
3	NAG	M	1	1,3	14,14,15	0.48	0	17,19,21	1.19	2 (11%)
3	NAG	M	2	3	14,14,15	0.52	0	17,19,21	1.53	1 (5%)
3	NAG	N	1	1,3	14,14,15	0.53	0	17,19,21	1.95	2 (11%)
3	NAG	N	2	3	14,14,15	0.57	0	17,19,21	1.53	1 (5%)
3	NAG	O	1	1,3	14,14,15	0.55	0	17,19,21	0.65	0
3	NAG	O	2	3	14,14,15	0.58	0	17,19,21	1.02	1 (5%)
5	NAG	P	1	1,5	14,14,15	0.49	0	17,19,21	1.19	2 (11%)
5	NAG	P	2	5	14,14,15	0.57	0	17,19,21	1.72	2 (11%)
5	MAN	P	3	5	11,11,12	0.50	0	15,15,17	1.55	3 (20%)
3	NAG	Q	1	1,3	14,14,15	0.53	0	17,19,21	1.86	2 (11%)
3	NAG	Q	2	3	14,14,15	0.56	0	17,19,21	1.42	1 (5%)
3	NAG	R	1	1,3	14,14,15	0.54	0	17,19,21	0.66	0
3	NAG	R	2	3	14,14,15	0.57	0	17,19,21	1.05	1 (5%)
5	NAG	S	1	1,5	14,14,15	0.47	0	17,19,21	1.18	2 (11%)
5	NAG	S	2	5	14,14,15	0.56	0	17,19,21	1.76	2 (11%)
5	MAN	S	3	5	11,11,12	0.52	0	15,15,17	1.56	3 (20%)
3	NAG	T	1	1,3	14,14,15	0.55	0	17,19,21	1.94	2 (11%)
3	NAG	T	2	3	14,14,15	0.56	0	17,19,21	1.47	1 (5%)

In the following table, the Chirals column lists the number of chiral outliers, the number of chiral centers analysed, the number of these observed in the model and the number defined in the Chemical Component Dictionary. Similar counts are reported in the Torsion and Rings columns. '2' means no outliers of that kind were identified.

Mol	Type	Chain	Res	Link	Chirals	Torsions	Rings
3	NAG	I	1	1,3	-	2/6/23/26	0/1/1/1
3	NAG	I	2	3	-	0/6/23/26	0/1/1/1
4	NAG	J	1	1,4	1/1/5/7	2/6/23/26	0/1/1/1
4	NAG	J	2	4	-	2/6/23/26	0/1/1/1
4	MAN	J	3	4	1/1/4/5	2/2/19/22	0/1/1/1
4	MAN	J	4	4	-	2/2/19/22	0/1/1/1
4	MAN	J	5	4	-	0/2/19/22	0/1/1/1
3	NAG	K	1	1,3	-	2/6/23/26	0/1/1/1
3	NAG	K	2	3	-	3/6/23/26	0/1/1/1
3	NAG	L	1	1,3	-	2/6/23/26	0/1/1/1
3	NAG	L	2	3	-	0/6/23/26	0/1/1/1
3	NAG	M	1	1,3	1/1/5/7	2/6/23/26	0/1/1/1
3	NAG	M	2	3	-	2/6/23/26	0/1/1/1
3	NAG	N	1	1,3	-	3/6/23/26	0/1/1/1
3	NAG	N	2	3	-	3/6/23/26	0/1/1/1
3	NAG	O	1	1,3	-	2/6/23/26	0/1/1/1
3	NAG	O	2	3	-	0/6/23/26	0/1/1/1
5	NAG	P	1	1,5	1/1/5/7	2/6/23/26	0/1/1/1
5	NAG	P	2	5	-	2/6/23/26	0/1/1/1
5	MAN	P	3	5	1/1/4/5	2/2/19/22	0/1/1/1
3	NAG	Q	1	1,3	-	2/6/23/26	0/1/1/1
3	NAG	Q	2	3	-	3/6/23/26	0/1/1/1
3	NAG	R	1	1,3	-	2/6/23/26	0/1/1/1
3	NAG	R	2	3	-	0/6/23/26	0/1/1/1
5	NAG	S	1	1,5	1/1/5/7	2/6/23/26	0/1/1/1
5	NAG	S	2	5	-	2/6/23/26	0/1/1/1
5	MAN	S	3	5	1/1/4/5	2/2/19/22	0/1/1/1
3	NAG	T	1	1,3	-	2/6/23/26	0/1/1/1
3	NAG	T	2	3	-	3/6/23/26	0/1/1/1

There are no bond length outliers.

The worst 5 of 48 bond angle outliers are listed below:

Mol	Chain	Res	Type	Atoms	Z	Observed(°)	Ideal(°)
3	N	1	NAG	C1-O5-C5	6.73	121.31	112.19
3	T	1	NAG	C1-O5-C5	6.59	121.13	112.19
3	Q	1	NAG	C1-O5-C5	6.39	120.85	112.19

Continued on next page...

Continued from previous page...

Mol	Chain	Res	Type	Atoms	Z	Observed(°)	Ideal(°)
3	K	1	NAG	C1-O5-C5	6.08	120.43	112.19
3	K	2	NAG	C1-O5-C5	5.68	119.89	112.19

5 of 7 chirality outliers are listed below:

Mol	Chain	Res	Type	Atom
4	J	1	NAG	C1
4	J	3	MAN	C1
5	P	1	NAG	C1
3	M	1	NAG	C1
5	P	3	MAN	C1

5 of 53 torsion outliers are listed below:

Mol	Chain	Res	Type	Atoms
3	K	1	NAG	C8-C7-N2-C2
3	K	1	NAG	O7-C7-N2-C2
3	T	1	NAG	C8-C7-N2-C2
3	T	1	NAG	O7-C7-N2-C2
3	N	2	NAG	C3-C2-N2-C7

There are no ring outliers.

16 monomers are involved in 29 short contacts:

Mol	Chain	Res	Type	Clashes	Symm-Clashes
3	M	2	NAG	1	0
3	T	1	NAG	1	0
4	J	1	NAG	4	0
4	J	3	MAN	2	0
5	P	2	NAG	3	0
4	J	2	NAG	3	0
5	P	1	NAG	4	0
3	T	2	NAG	1	0
3	M	1	NAG	4	0
5	P	3	MAN	2	0
5	S	2	NAG	4	0
5	S	3	MAN	3	0
5	S	1	NAG	4	0
3	Q	1	NAG	1	0
4	J	5	MAN	4	0
3	Q	2	NAG	1	0

The following is a two-dimensional graphical depiction of Mogul quality analysis of bond lengths, bond angles, torsion angles, and ring geometry for oligosaccharide.

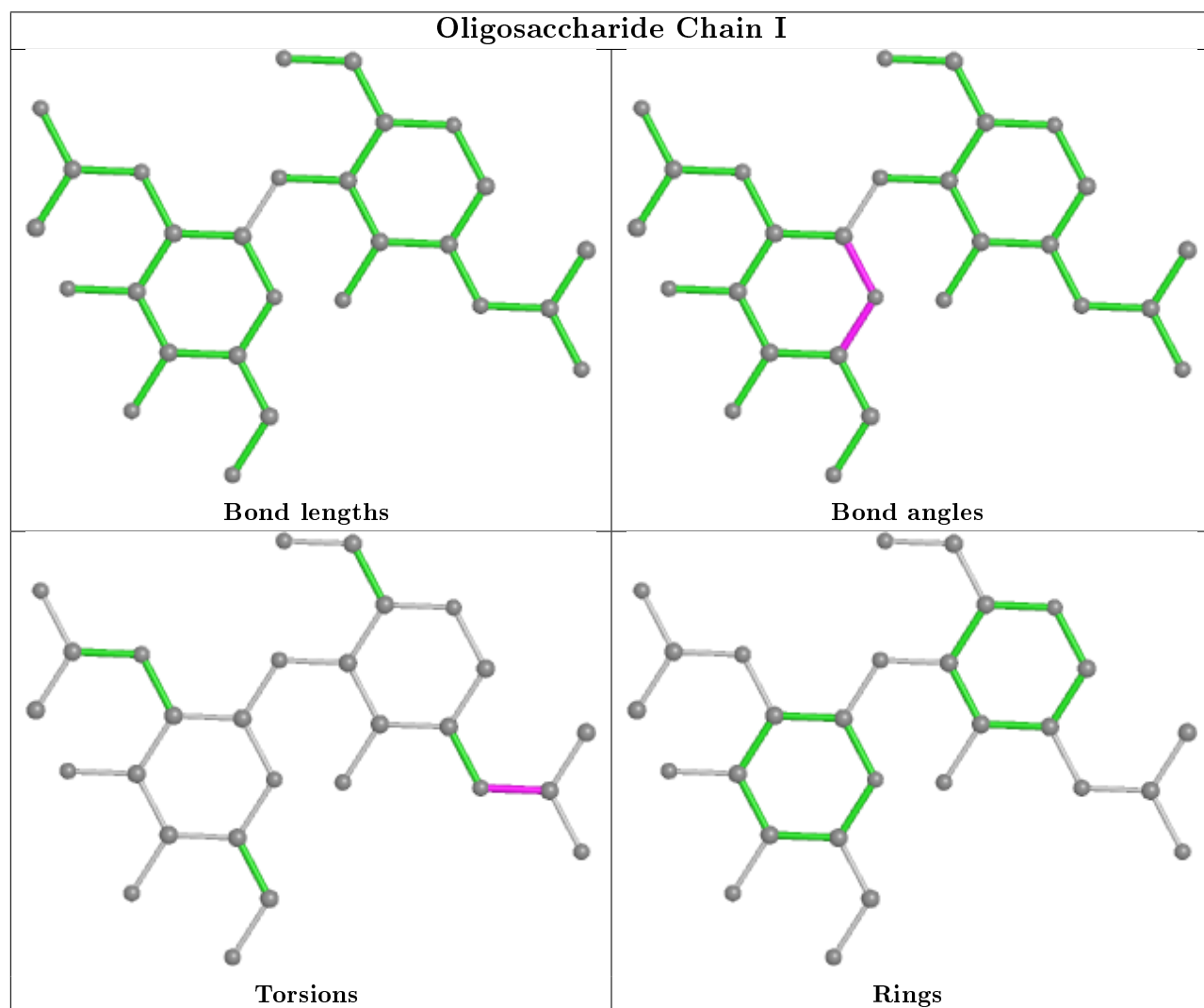

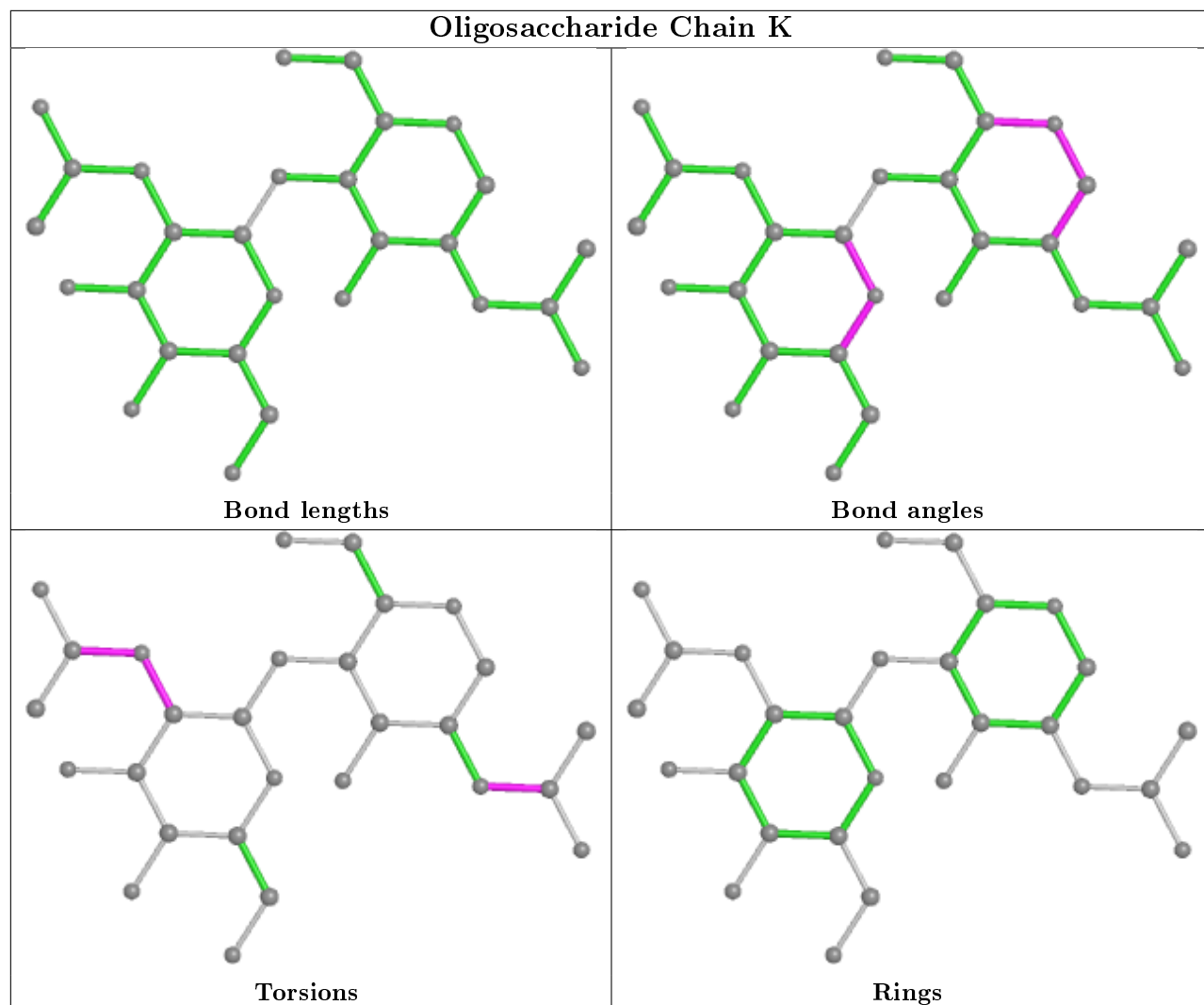

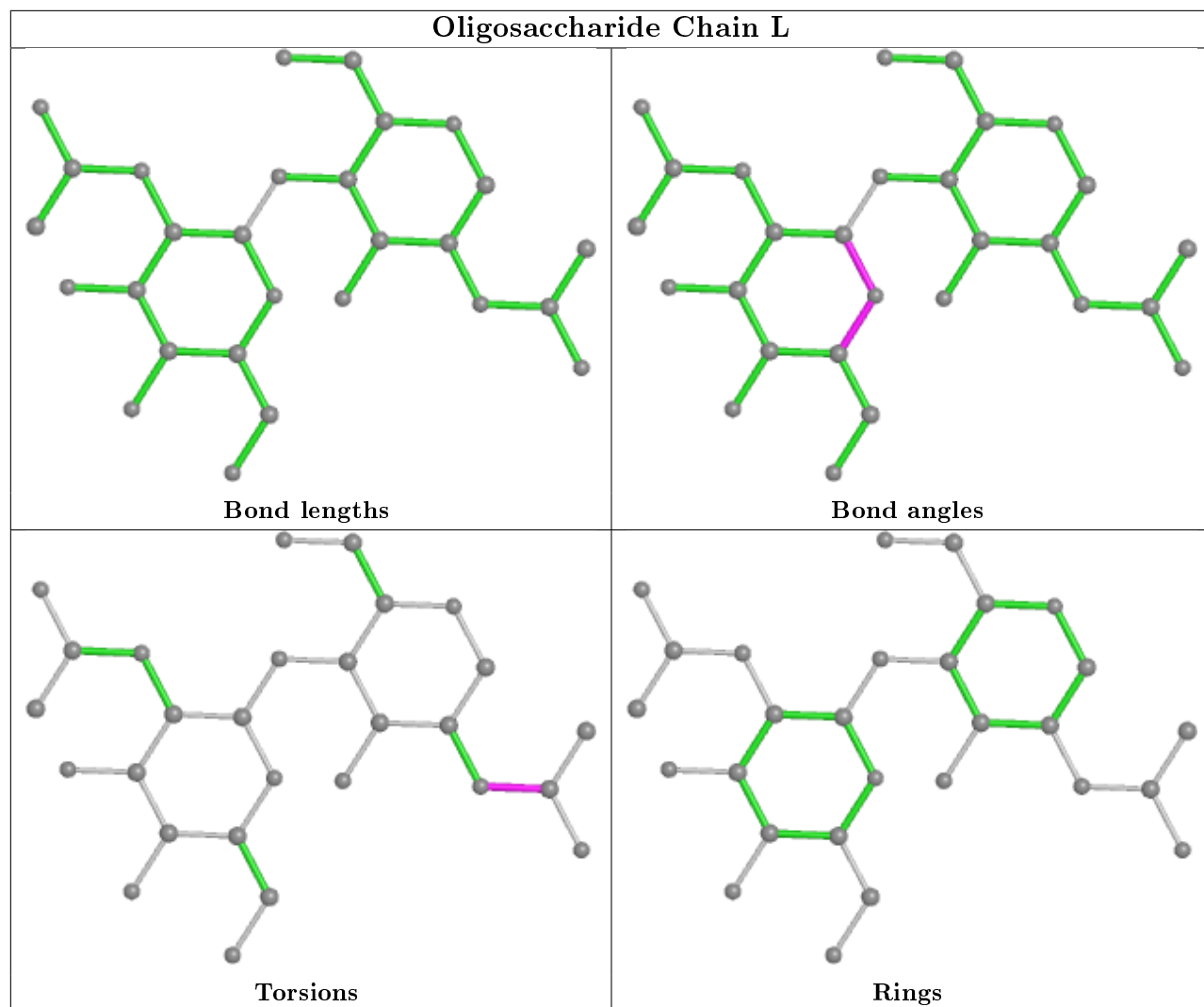

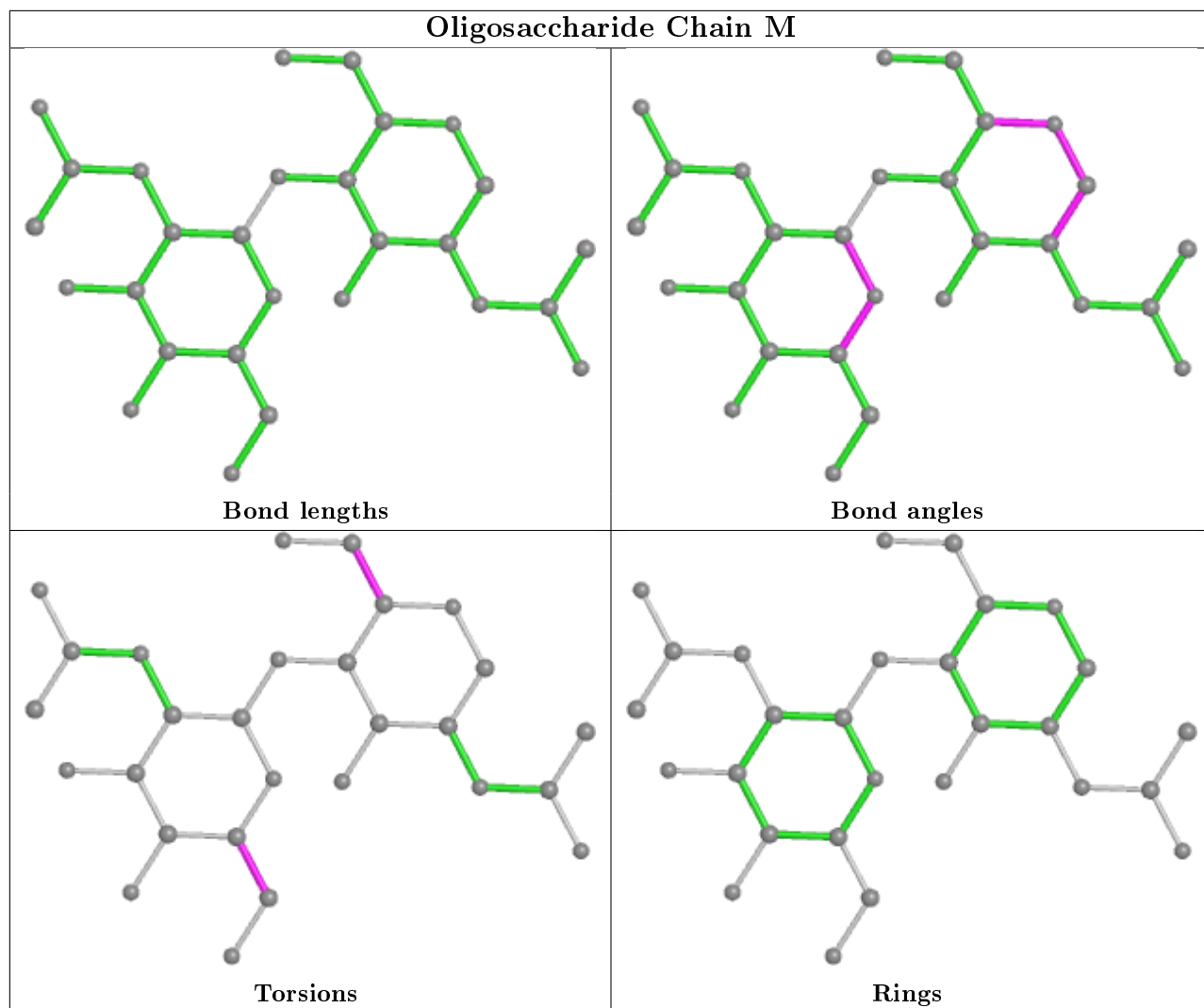

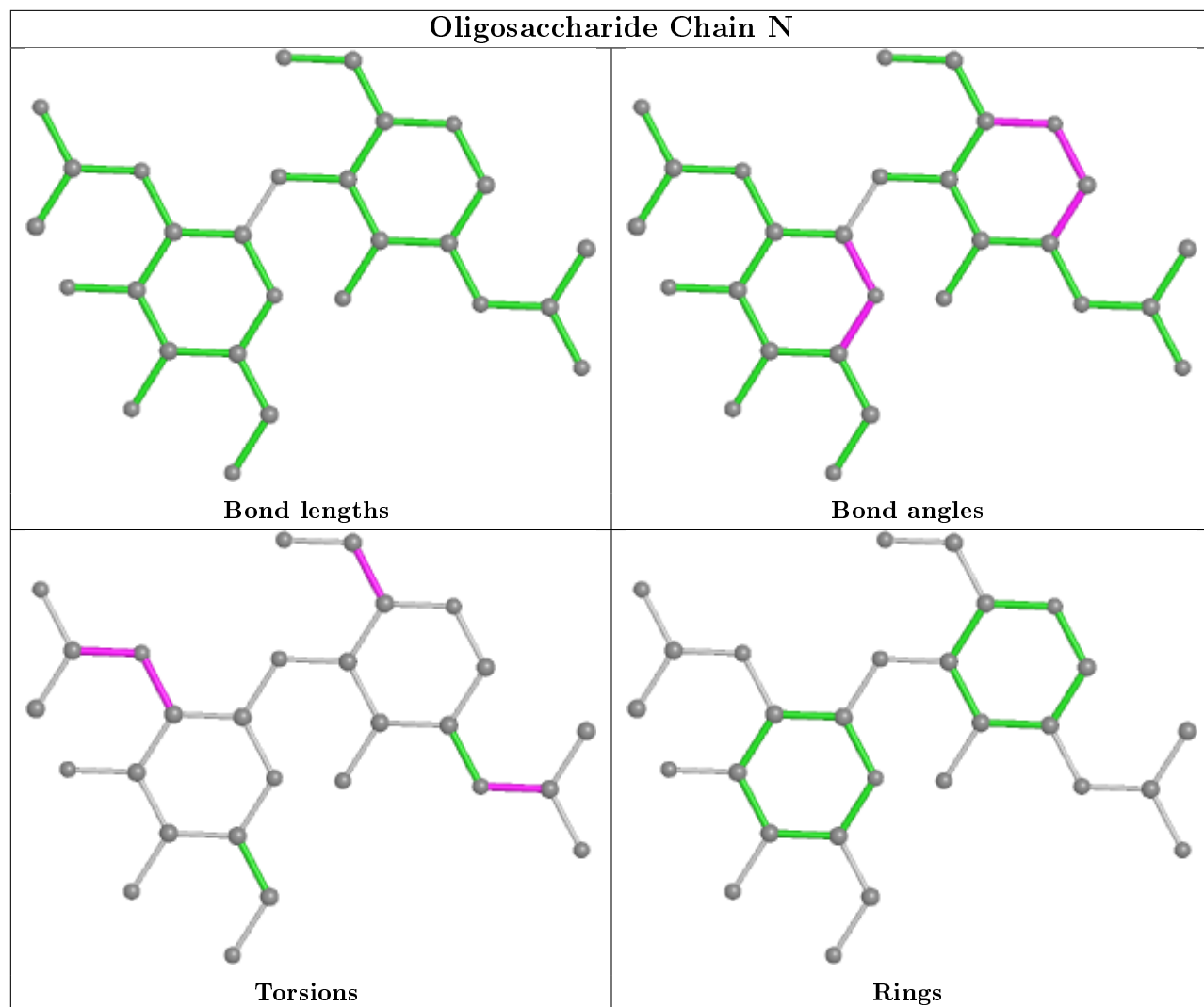

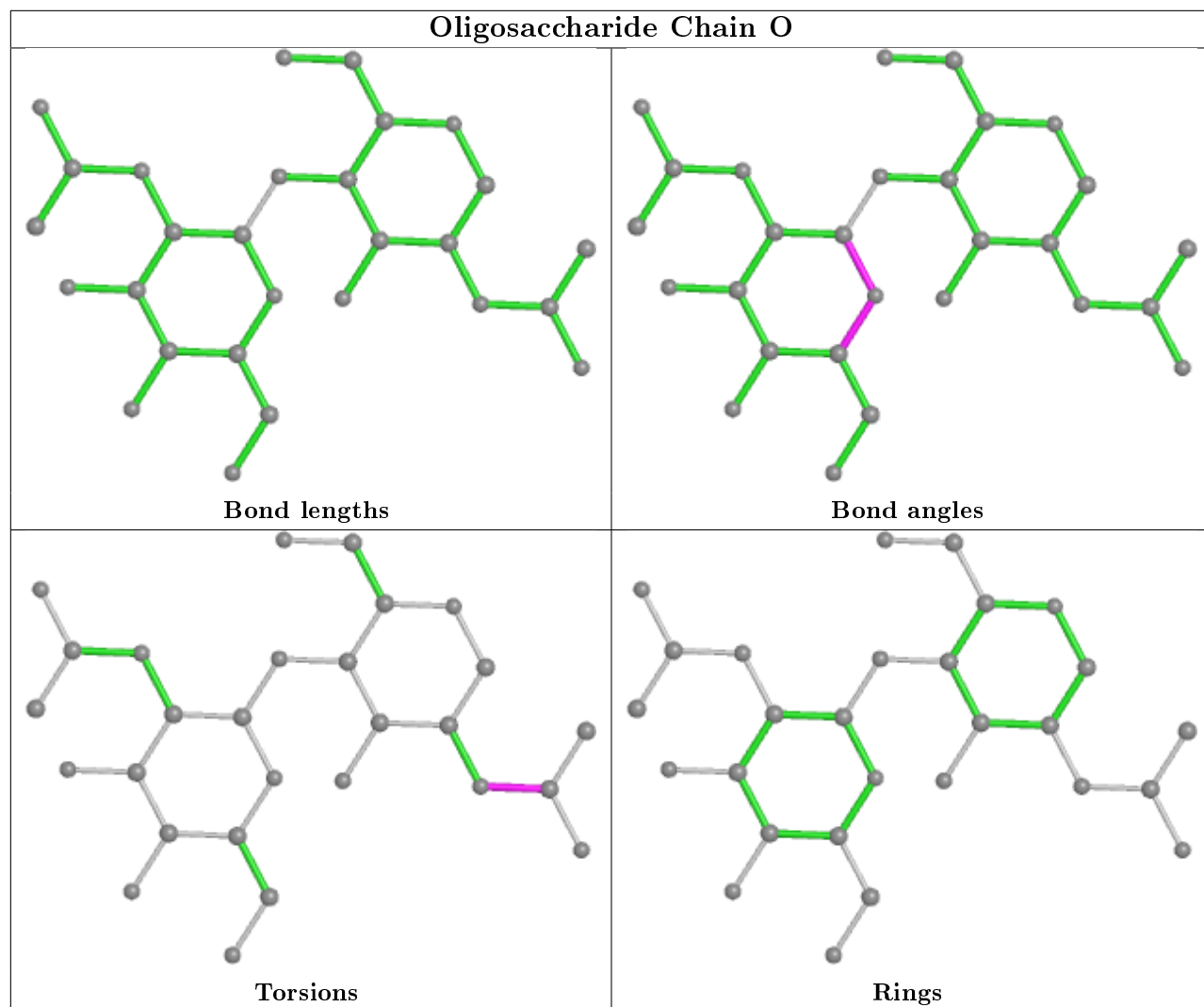

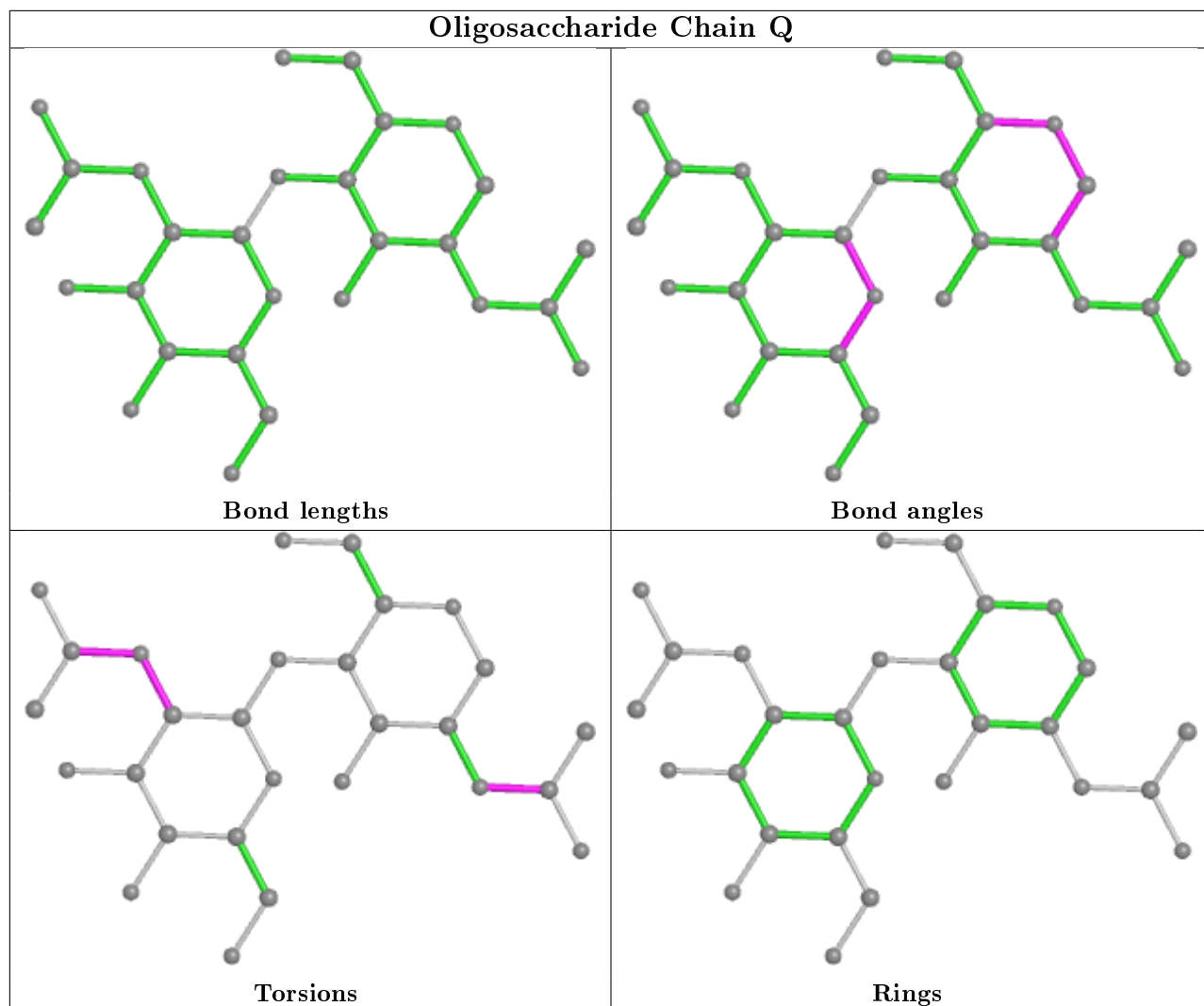

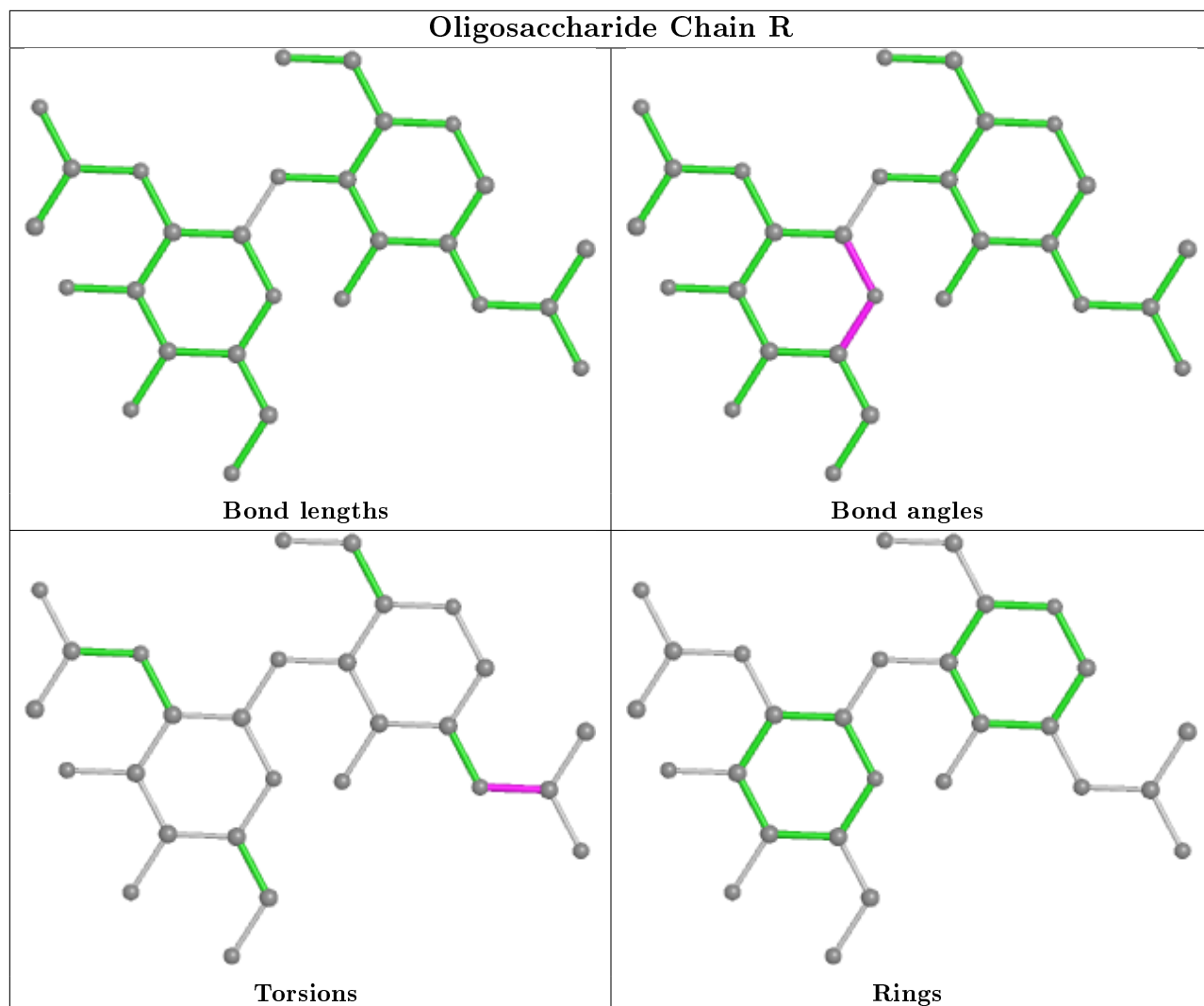

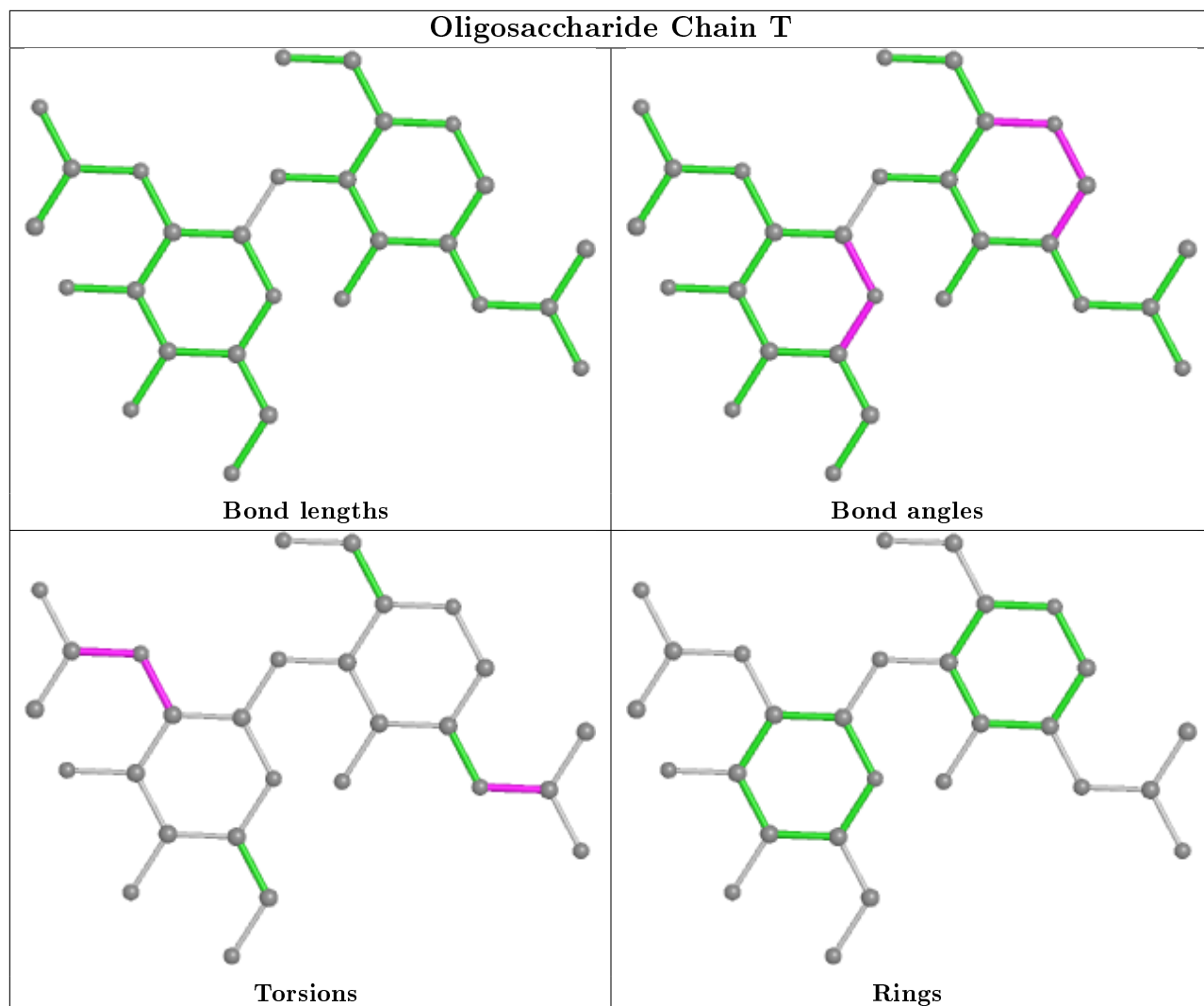

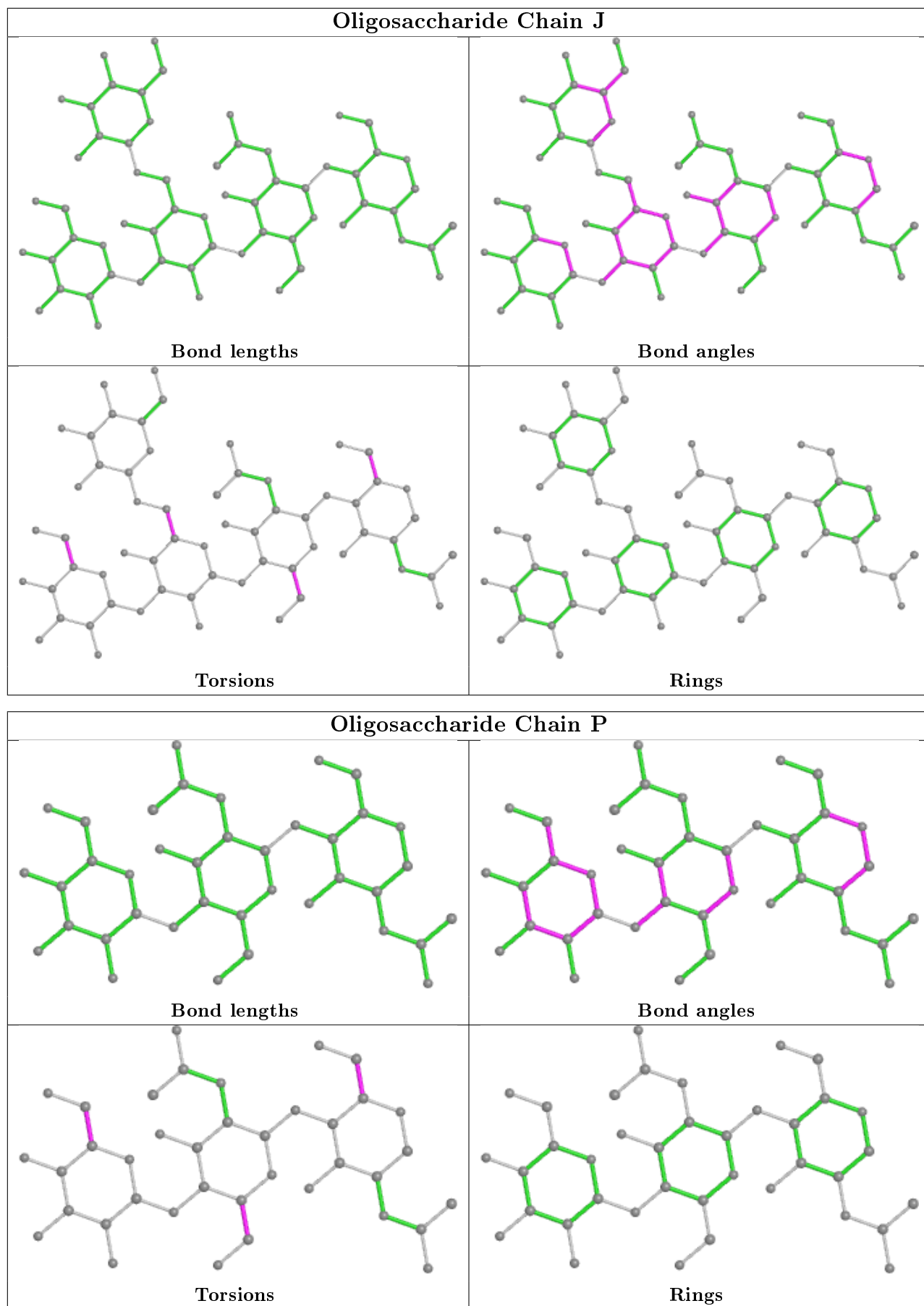

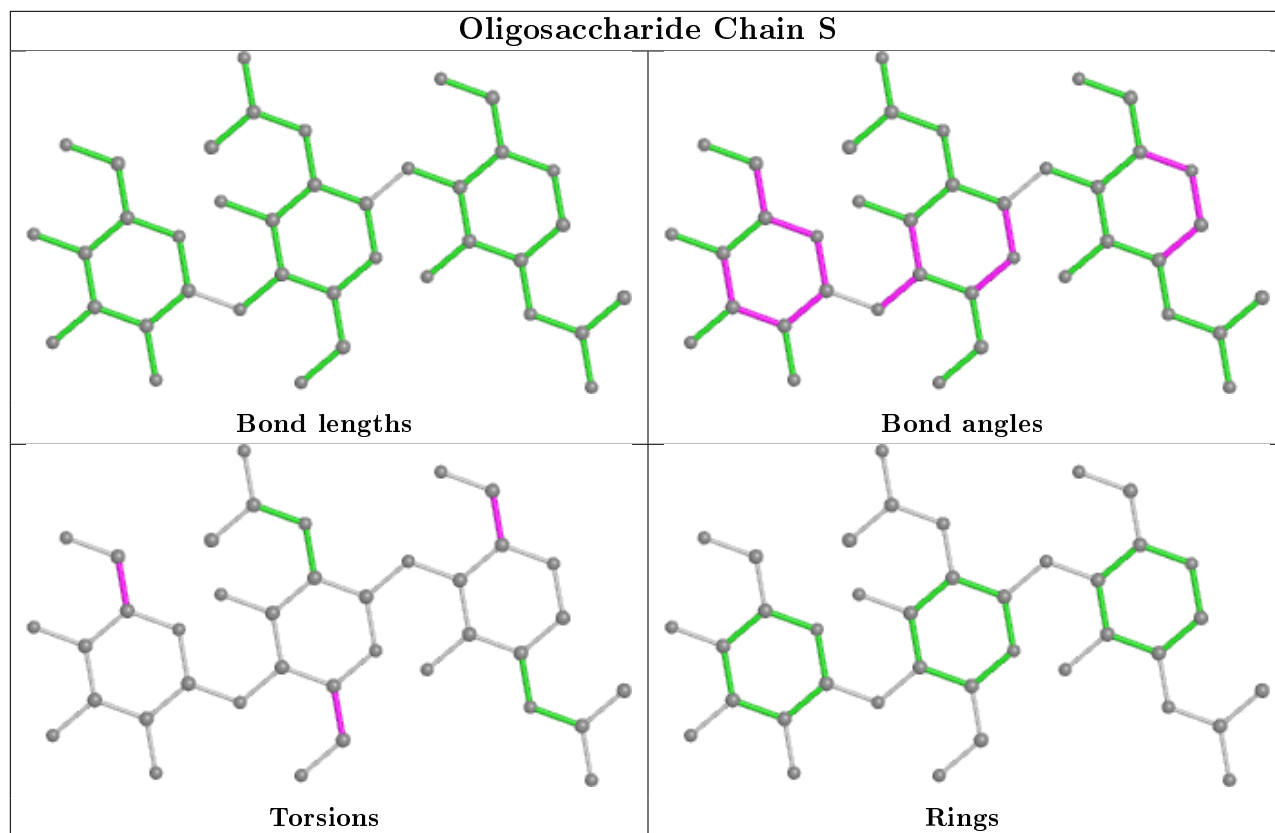

5.6 Ligand geometry [i](#)

Of 30 ligands modelled in this entry, 17 are monoatomic - leaving 13 for Mogul analysis.

In the following table, the Counts columns list the number of bonds (or angles) for which Mogul statistics could be retrieved, the number of bonds (or angles) that are observed in the model and the number of bonds (or angles) that are defined in the Chemical Component Dictionary. The Link column lists molecule types, if any, to which the group is linked. The Z score for a bond length (or angle) is the number of standard deviations the observed value is removed from the expected value. A bond length (or angle) with $|Z| > 2$ is considered an outlier worth inspection. RMSZ is the root-mean-square of all Z scores of the bond lengths (or angles).

Mol	Type	Chain	Res	Link	Bond lengths			Bond angles		
					Counts	RMSZ	$\# Z > 2$	Counts	RMSZ	$\# Z > 2$
7	NAG	G	3678	1	14,14,15	0.52	0	17,19,21	0.99	1 (5%)
7	NAG	A	3678	1	14,14,15	0.51	0	17,19,21	1.00	1 (5%)
7	NAG	C	3678	1	14,14,15	0.50	0	17,19,21	0.95	1 (5%)
7	NAG	D	3094	2	14,14,15	0.53	0	17,19,21	0.74	0
7	NAG	E	3880	1	14,14,15	0.42	0	17,19,21	1.14	1 (5%)
7	NAG	C	3880	1	14,14,15	0.43	0	17,19,21	1.06	1 (5%)
7	NAG	B	3094	2	14,14,15	0.50	0	17,19,21	0.77	0
7	NAG	G	3880	1	14,14,15	0.44	0	17,19,21	1.03	1 (5%)

Mol	Type	Chain	Res	Link	Bond lengths			Bond angles		
					Counts	RMSZ	# Z > 2	Counts	RMSZ	# Z > 2
7	NAG	A	3880	1	14,14,15	0.43	0	17,19,21	1.15	1 (5%)
7	NAG	H	3094	2	14,14,15	0.51	0	17,19,21	0.76	0
6	MAN	A	3378	-	11,11,12	1.08	0	15,15,17	5.70	6 (40%)
7	NAG	E	3678	1	14,14,15	0.53	0	17,19,21	1.02	2 (11%)
7	NAG	F	3094	2	14,14,15	0.50	0	17,19,21	0.78	0

In the following table, the Chirals column lists the number of chiral outliers, the number of chiral centers analysed, the number of these observed in the model and the number defined in the Chemical Component Dictionary. Similar counts are reported in the Torsion and Rings columns. '-' means no outliers of that kind were identified.

Mol	Type	Chain	Res	Link	Chirals	Torsions	Rings
7	NAG	G	3678	1	-	2/6/23/26	0/1/1/1
7	NAG	A	3678	1	-	2/6/23/26	0/1/1/1
7	NAG	C	3678	1	-	2/6/23/26	0/1/1/1
7	NAG	D	3094	2	-	1/6/23/26	0/1/1/1
7	NAG	E	3880	1	-	3/6/23/26	0/1/1/1
7	NAG	C	3880	1	-	3/6/23/26	0/1/1/1
7	NAG	B	3094	2	-	2/6/23/26	0/1/1/1
7	NAG	G	3880	1	-	3/6/23/26	0/1/1/1
7	NAG	A	3880	1	-	4/6/23/26	0/1/1/1
7	NAG	H	3094	2	-	1/6/23/26	0/1/1/1
6	MAN	A	3378	-	-	2/2/19/22	0/1/1/1
7	NAG	E	3678	1	-	2/6/23/26	0/1/1/1
7	NAG	F	3094	2	-	1/6/23/26	0/1/1/1

There are no bond length outliers.

The worst 5 of 15 bond angle outliers are listed below:

Mol	Chain	Res	Type	Atoms	Z	Observed(°)	Ideal(°)
6	A	3378	MAN	C1-C2-C3	-17.49	88.17	109.67
6	A	3378	MAN	C1-O5-C5	-11.49	96.63	112.19
6	A	3378	MAN	C3-C4-C5	4.78	118.76	110.24
7	A	3880	NAG	C1-O5-C5	3.54	117.00	112.19
7	E	3880	NAG	C1-O5-C5	3.48	116.90	112.19

There are no chirality outliers.

5 of 28 torsion outliers are listed below:

Mol	Chain	Res	Type	Atoms
7	E	3880	NAG	C8-C7-N2-C2
7	E	3880	NAG	O7-C7-N2-C2
7	A	3880	NAG	C8-C7-N2-C2
7	A	3880	NAG	O7-C7-N2-C2
7	C	3880	NAG	C8-C7-N2-C2

There are no ring outliers.

3 monomers are involved in 6 short contacts:

Mol	Chain	Res	Type	Clashes	Symm-Clashes
7	G	3678	NAG	1	0
7	C	3678	NAG	1	0
6	A	3378	MAN	4	0

5.7 Other polymers [i](#)

There are no such residues in this entry.

5.8 Polymer linkage issues [i](#)

There are no chain breaks in this entry.

6 Fit of model and data [i](#)

6.1 Protein, DNA and RNA chains [i](#)

In the following table, the column labelled '#RSRZ > 2' contains the number (and percentage) of RSRZ outliers, followed by percent RSRZ outliers for the chain as percentile scores relative to all X-ray entries and entries of similar resolution. The OWAB column contains the minimum, median, 95th percentile and maximum values of the occupancy-weighted average B-factor per residue. The column labelled 'Q < 0.9' lists the number of (and percentage) of residues with an average occupancy less than 0.9.

Mol	Chain	Analysed	<RSRZ>	#RSRZ>2	OWAB(Å ²)	Q<0.9
1	A	1082/1095 (98%)	-0.09	24 (2%) 62 56	61, 153, 256, 362	0
1	C	885/1095 (80%)	0.19	52 (5%) 22 20	67, 172, 280, 410	0
1	E	884/1095 (80%)	-0.05	31 (3%) 44 39	65, 157, 266, 337	0
1	G	885/1095 (80%)	-0.09	25 (2%) 53 47	74, 150, 266, 342	0
2	B	674/687 (98%)	0.32	49 (7%) 15 15	100, 205, 286, 421	2 (0%)
2	D	674/687 (98%)	1.07	168 (24%) 0 0	107, 229, 313, 416	2 (0%)
2	F	674/687 (98%)	0.46	68 (10%) 7 7	98, 207, 289, 374	2 (0%)
2	H	674/687 (98%)	0.48	71 (10%) 6 7	100, 210, 293, 390	2 (0%)
All	All	6432/7128 (90%)	0.23	488 (7%) 13 14	61, 185, 283, 421	8 (0%)

The worst 5 of 488 RSRZ outliers are listed below:

Mol	Chain	Res	Type	RSRZ
2	H	72	GLY	16.4
2	B	72	GLY	12.3
2	H	73	GLN	11.2
2	B	92	ALA	9.8
1	C	817	GLN	9.6

6.2 Non-standard residues in protein, DNA, RNA chains [i](#)

There are no non-standard protein/DNA/RNA residues in this entry.

6.3 Carbohydrates [i](#)

In the following table, the Atoms column lists the number of modelled atoms in the group and the number defined in the chemical component dictionary. The B-factors column lists the minimum,

median, 95th percentile and maximum values of B factors of atoms in the group. The column labelled 'Q< 0.9' lists the number of atoms with occupancy less than 0.9.

Mol	Type	Chain	Res	Atoms	RSCC	RSR	B-factors(Å ²)	Q<0.9
5	MAN	P	3	11/12	0.36	0.30	171,251,305,311	0
3	NAG	O	2	14/15	0.60	0.47	183,310,366,378	0
3	NAG	N	2	14/15	0.61	0.76	224,297,342,395	0
3	NAG	M	2	14/15	0.63	0.64	136,238,359,434	0
3	NAG	R	2	14/15	0.63	0.26	176,248,297,317	0
5	MAN	S	3	11/12	0.65	0.28	173,208,309,351	0
4	MAN	J	4	11/12	0.66	0.22	114,259,296,316	0
3	NAG	M	1	14/15	0.68	0.42	198,292,381,425	0
3	NAG	L	2	14/15	0.70	0.42	179,305,351,363	0
5	NAG	S	2	14/15	0.70	0.45	136,261,326,367	0
4	MAN	J	5	11/12	0.70	0.20	99,256,308,331	0
4	NAG	J	2	14/15	0.72	0.32	91,240,362,435	0
3	NAG	R	1	14/15	0.75	0.27	193,244,274,279	0
3	NAG	L	1	14/15	0.77	0.28	150,232,327,335	0
5	NAG	P	2	14/15	0.78	0.37	201,279,352,410	0
4	MAN	J	3	11/12	0.80	0.16	140,207,283,324	0
3	NAG	I	2	14/15	0.81	0.26	80,233,327,333	0
5	NAG	P	1	14/15	0.81	0.44	146,324,390,464	0
3	NAG	O	1	14/15	0.82	0.47	198,249,285,287	0
3	NAG	T	2	14/15	0.84	0.29	192,216,305,376	0
5	NAG	S	1	14/15	0.84	0.34	106,265,384,401	0
3	NAG	I	1	14/15	0.85	0.18	133,175,235,244	0
4	NAG	J	1	14/15	0.85	0.32	136,261,376,443	0
3	NAG	K	2	14/15	0.88	0.31	185,218,319,381	0
3	NAG	Q	2	14/15	0.88	0.22	117,240,280,337	0
3	NAG	T	1	14/15	0.90	0.22	77,188,300,303	0
3	NAG	N	1	14/15	0.91	0.17	60,167,211,249	0
3	NAG	Q	1	14/15	0.92	0.22	49,184,277,297	0
3	NAG	K	1	14/15	0.96	0.17	28,156,272,274	0

The following is a graphical depiction of the model fit to experimental electron density for oligosaccharide. Each fit is shown from different orientation to approximate a three-dimensional view.

Electron density around Chain I:

$2mF_o-DF_c$ (at 0.7 rmsd) in gray
 mF_o-DF_c (at 3 rmsd) in purple (negative)
and green (positive)

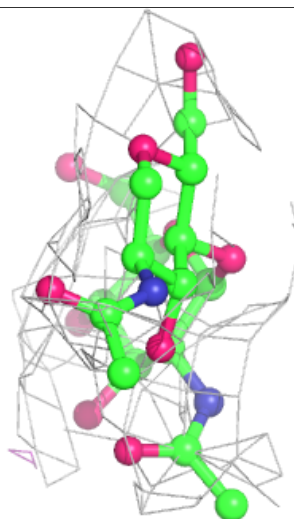
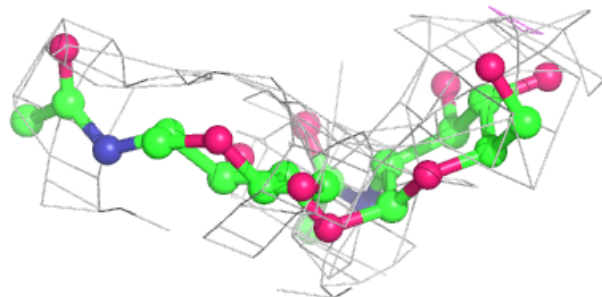
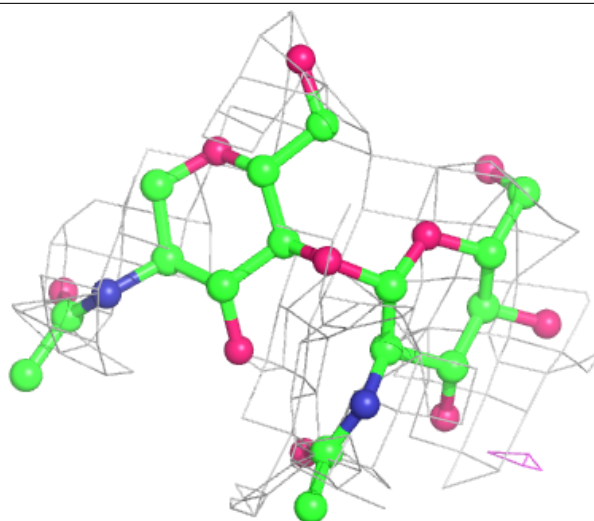

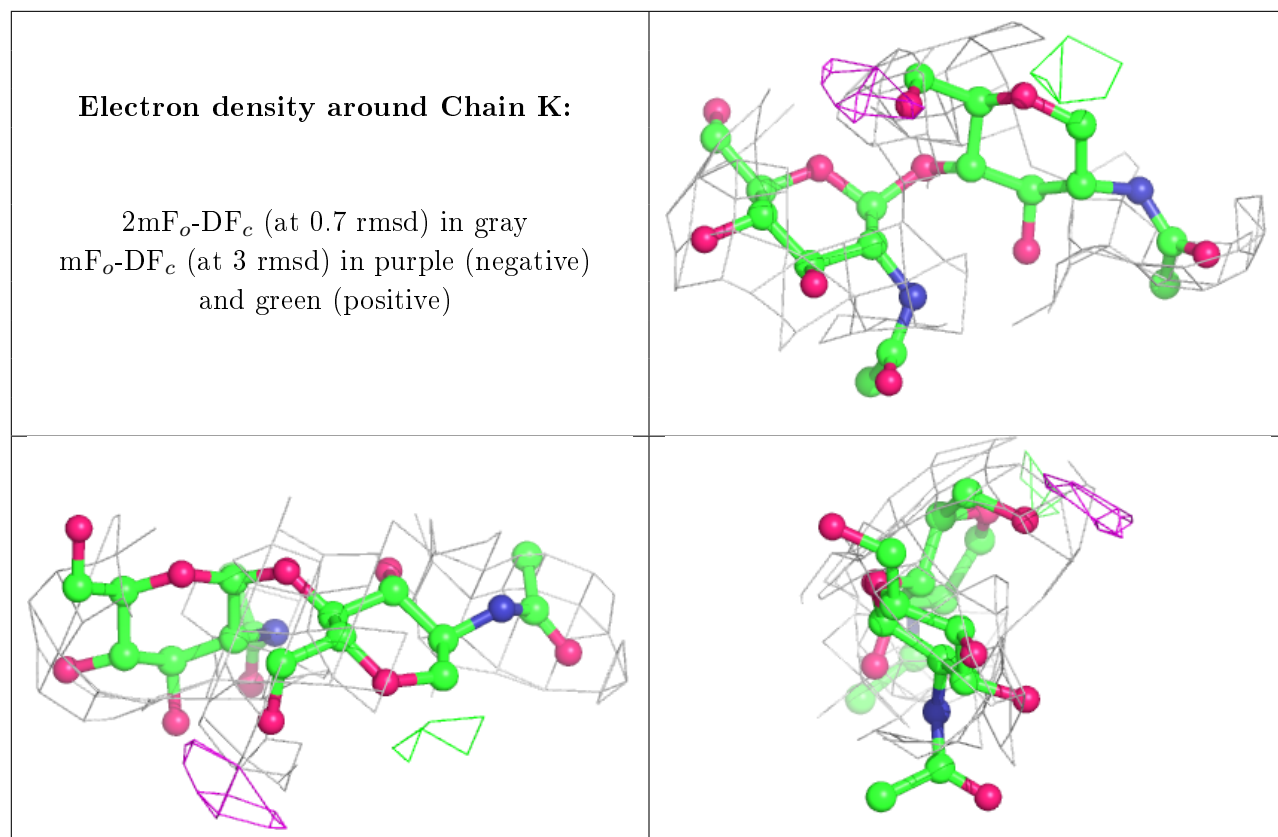

Electron density around Chain L:

$2mF_o-DF_c$ (at 0.7 rmsd) in gray
 mF_o-DF_c (at 3 rmsd) in purple (negative)
and green (positive)

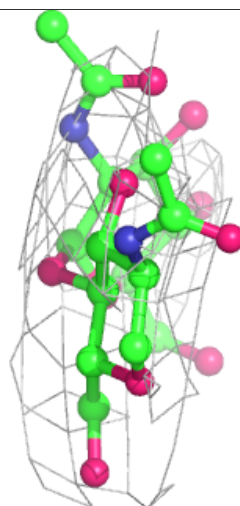
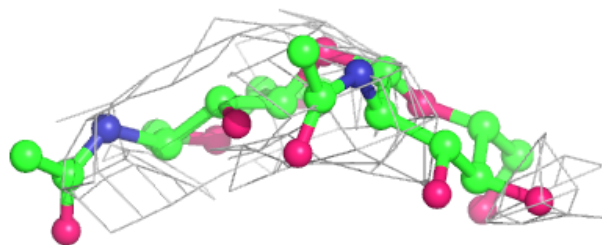
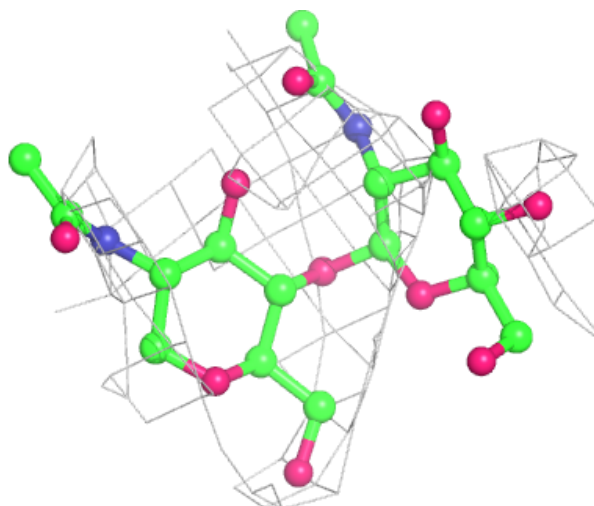

Electron density around Chain M:

$2mF_o-DF_c$ (at 0.7 rmsd) in gray
 mF_o-DF_c (at 3 rmsd) in purple (negative)
and green (positive)

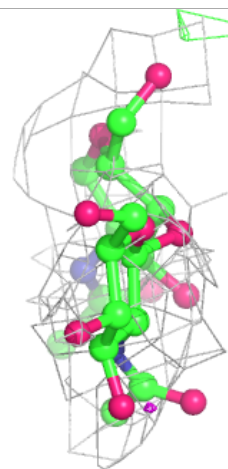
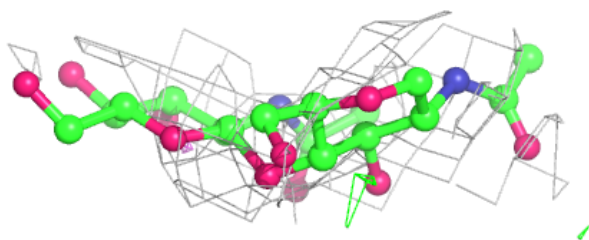
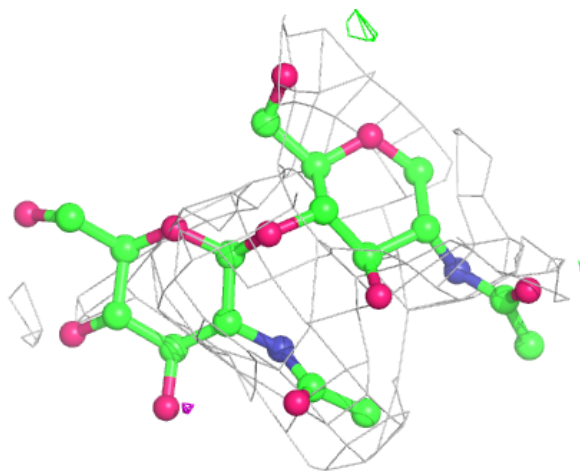

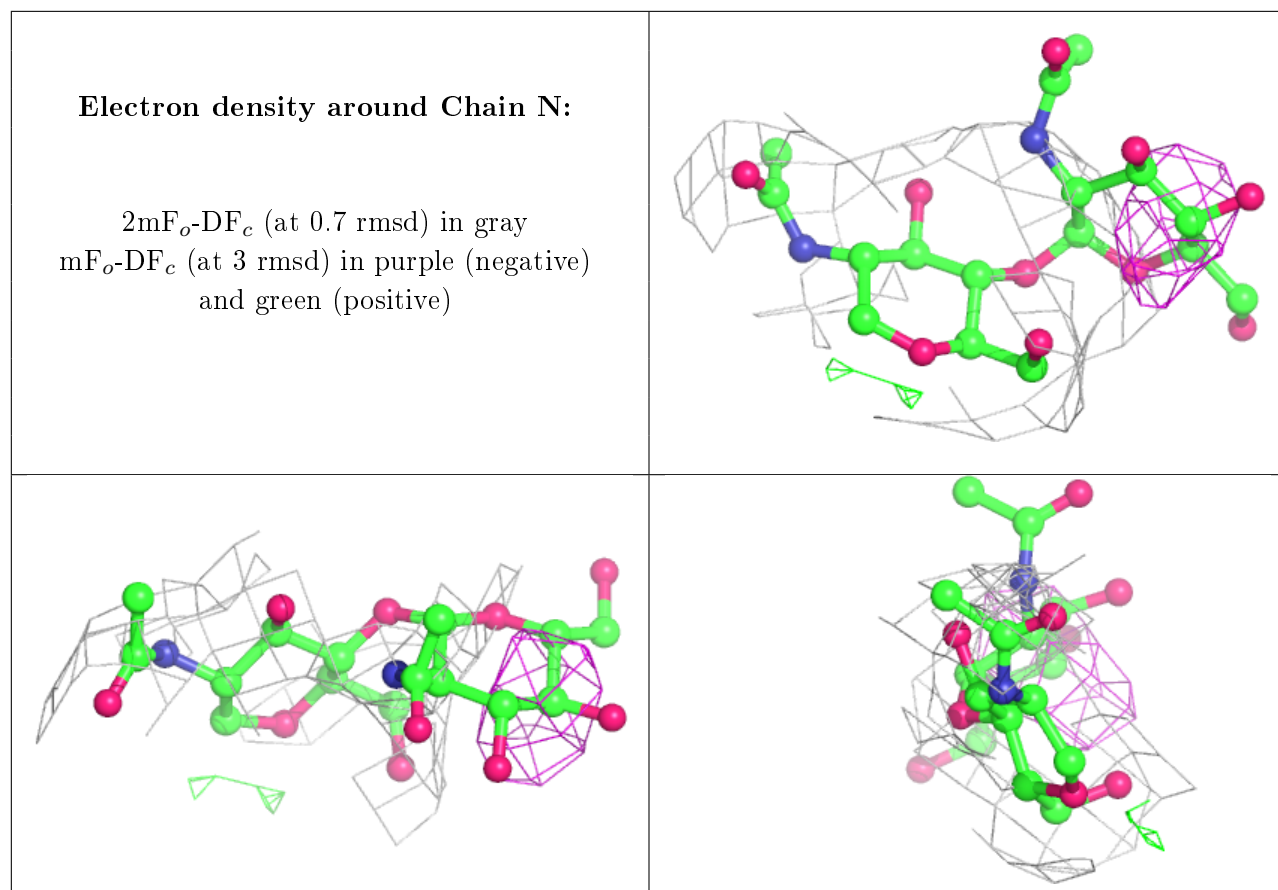

Electron density around Chain O:

$2mF_o-DF_c$ (at 0.7 rmsd) in gray
 mF_o-DF_c (at 3 rmsd) in purple (negative)
and green (positive)

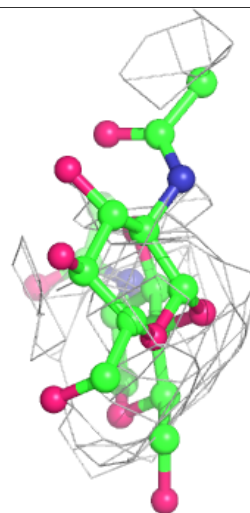
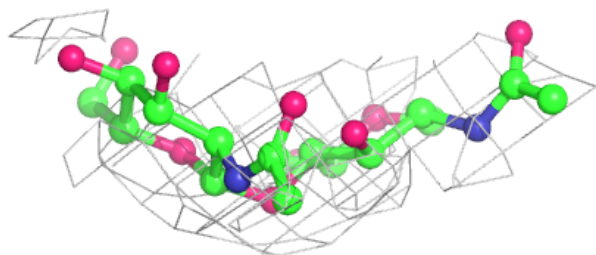
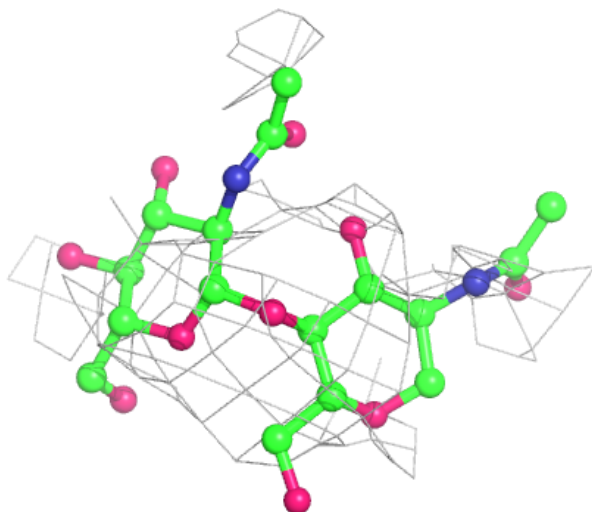

Electron density around Chain Q:

$2mF_o-DF_c$ (at 0.7 rmsd) in gray
 mF_o-DF_c (at 3 rmsd) in purple (negative)
and green (positive)

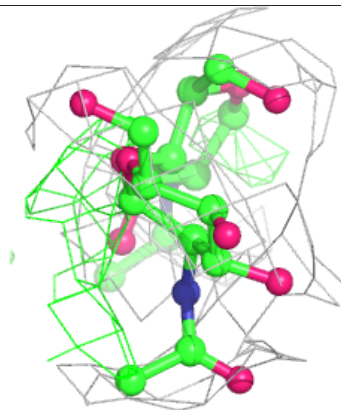
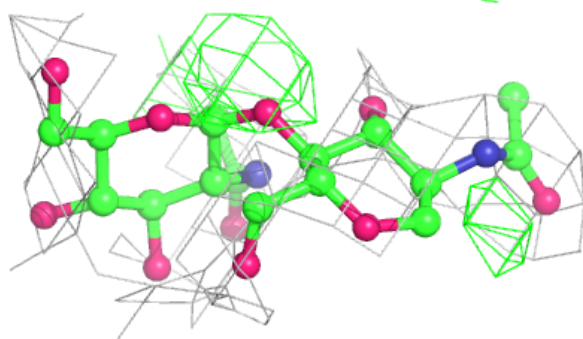
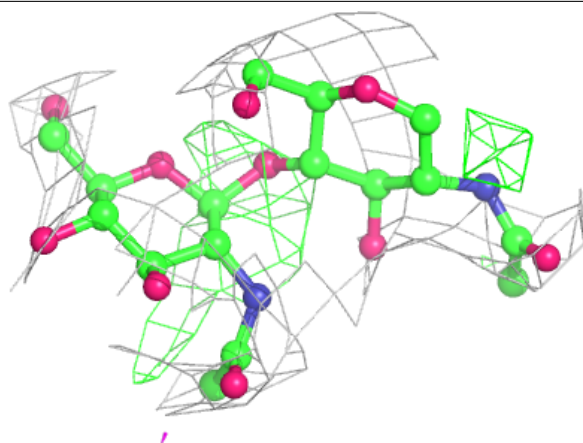

Electron density around Chain R:

$2mF_o-DF_c$ (at 0.7 rmsd) in gray
 mF_o-DF_c (at 3 rmsd) in purple (negative)
and green (positive)

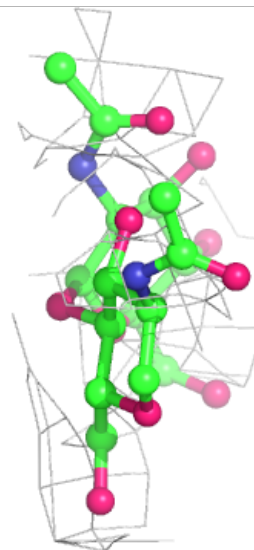
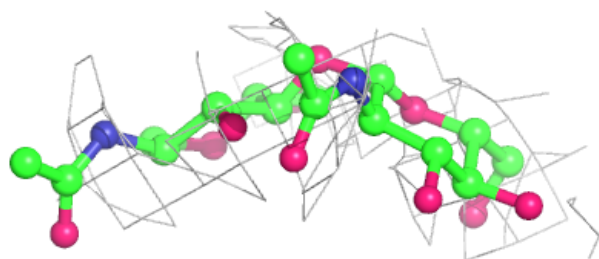
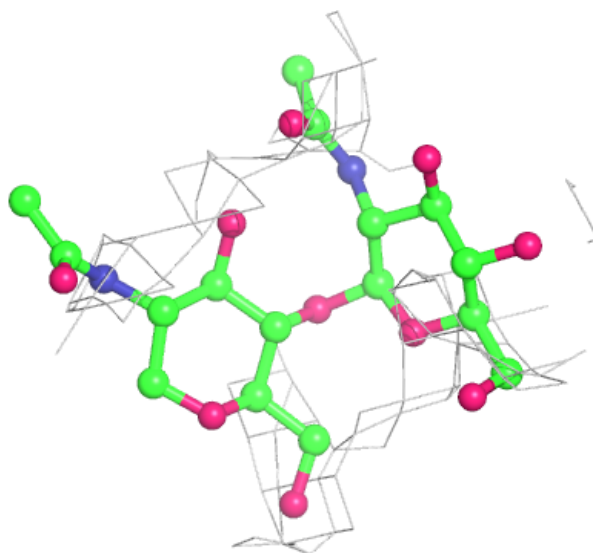

Electron density around Chain T:

$2mF_o-DF_c$ (at 0.7 rmsd) in gray
 mF_o-DF_c (at 3 rmsd) in purple (negative)
and green (positive)

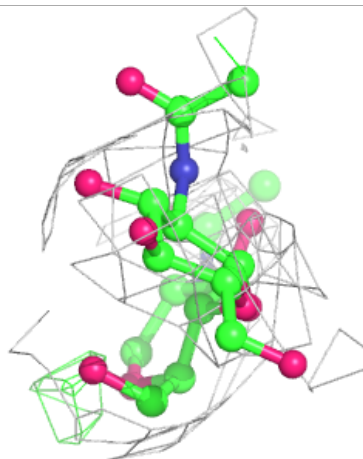
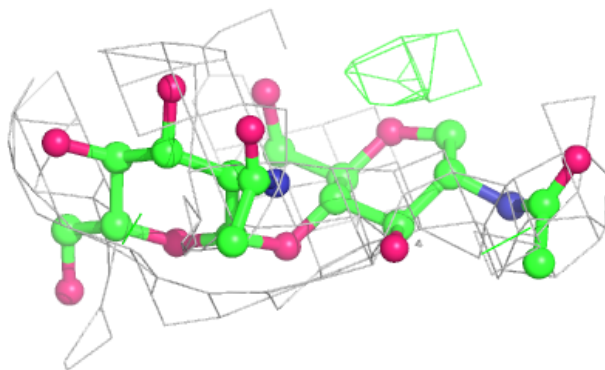
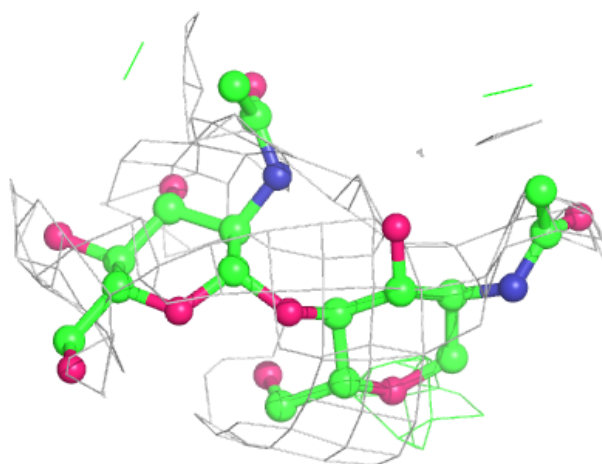

Electron density around Chain J:

$2mF_o-DF_c$ (at 0.7 rmsd) in gray
 mF_o-DF_c (at 3 rmsd) in purple (negative)
and green (positive)

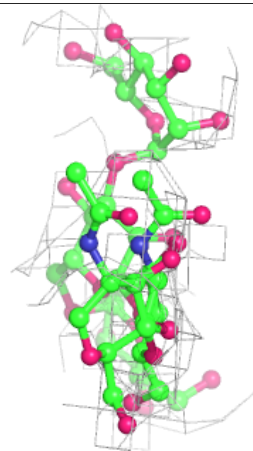
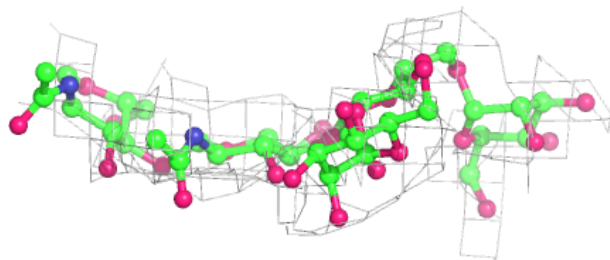
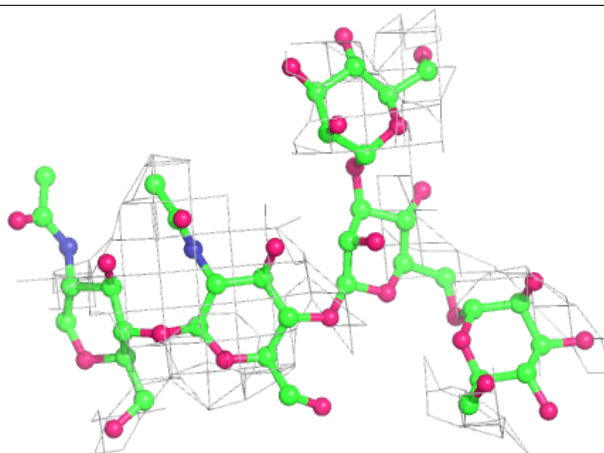
**Electron density around Chain P:**

$2mF_o-DF_c$ (at 0.7 rmsd) in gray
 mF_o-DF_c (at 3 rmsd) in purple (negative)
and green (positive)

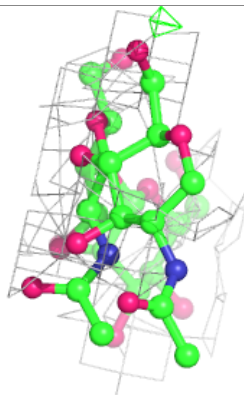
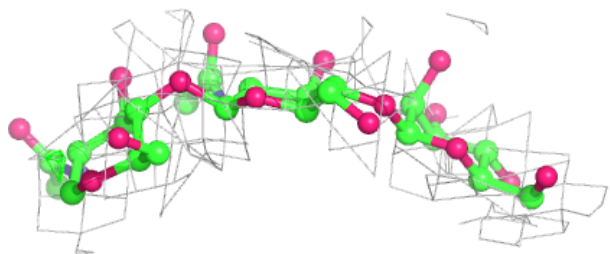
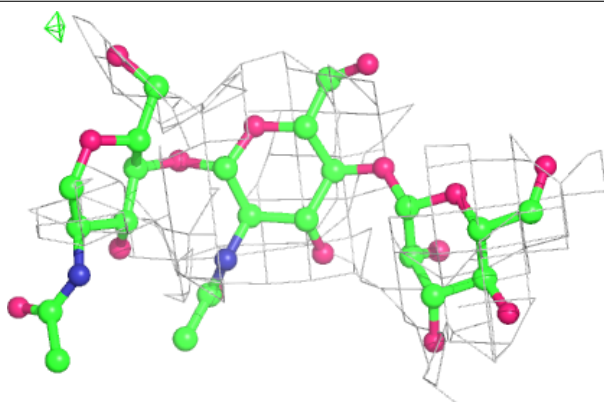

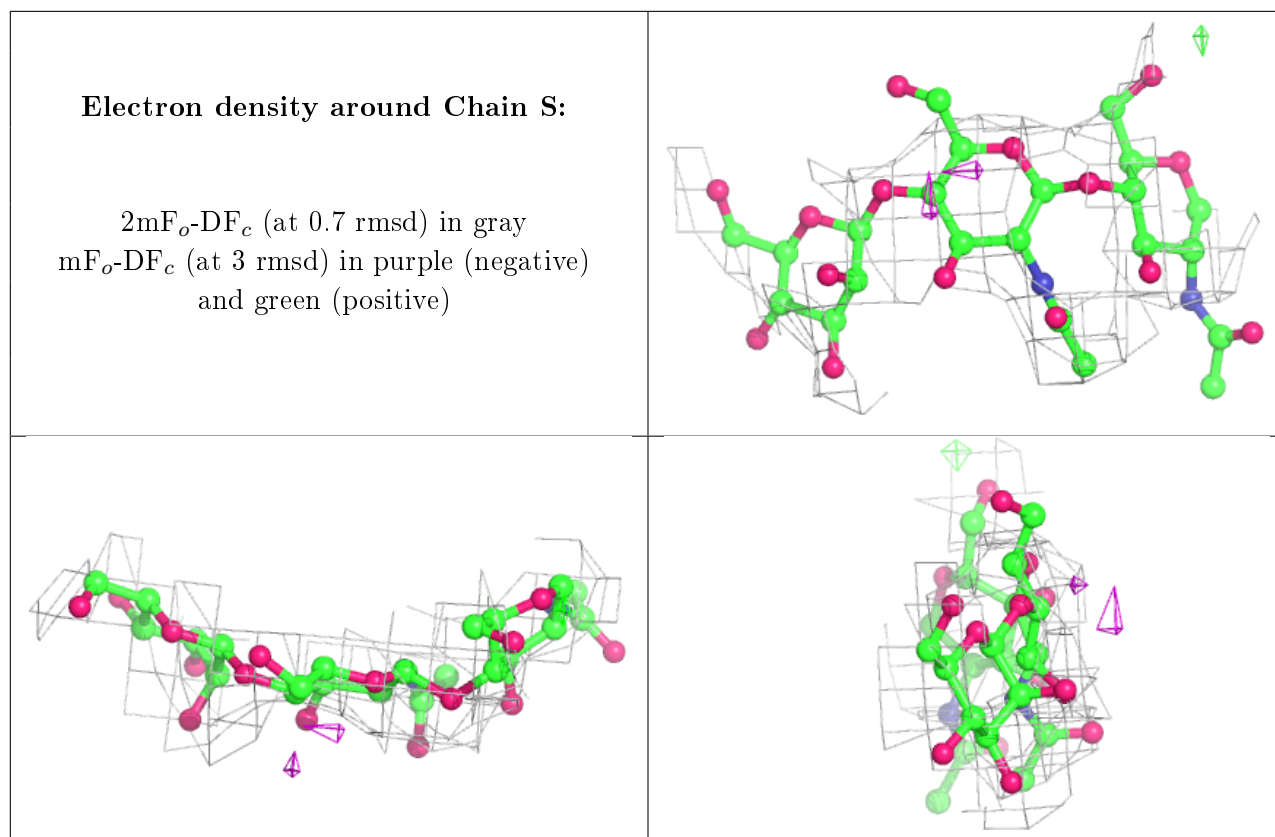

6.4 Ligands [i](#)

In the following table, the Atoms column lists the number of modelled atoms in the group and the number defined in the chemical component dictionary. The B-factors column lists the minimum, median, 95th percentile and maximum values of B factors of atoms in the group. The column labelled 'Q< 0.9' lists the number of atoms with occupancy less than 0.9.

Mol	Type	Chain	Res	Atoms	RSCC	RSR	B-factors(\AA^2)	Q<0.9
7	NAG	D	3094	14/15	0.45	0.82	189,258,296,299	0
8	CA	H	2002	1/1	0.60	0.13	510,510,510,510	0
8	CA	D	2002	1/1	0.62	0.17	547,547,547,547	0
6	MAN	A	3378	11/12	0.63	0.29	171,186,272,293	0
8	CA	G	2007	1/1	0.64	0.06	150,150,150,150	0
8	CA	A	2005	1/1	0.70	0.10	145,145,145,145	0
7	NAG	C	3678	14/15	0.72	0.48	125,245,317,319	0
8	CA	C	2005	1/1	0.76	0.06	200,200,200,200	0
8	CA	C	2007	1/1	0.78	0.07	206,206,206,206	0
7	NAG	B	3094	14/15	0.78	0.28	107,197,277,325	0
7	NAG	H	3094	14/15	0.81	0.40	148,232,292,297	0
8	CA	B	2002	1/1	0.81	0.09	535,535,535,535	0
8	CA	A	2006	1/1	0.81	0.11	107,107,107,107	0
7	NAG	A	3678	14/15	0.82	0.42	117,269,324,327	0

Continued on next page...

Continued from previous page...

Mol	Type	Chain	Res	Atoms	RSCC	RSR	B-factors(Å ²)	Q<0.9
7	NAG	G	3678	14/15	0.84	0.51	132,218,244,251	0
7	NAG	F	3094	14/15	0.84	0.27	124,217,266,291	0
7	NAG	E	3678	14/15	0.85	0.25	104,227,276,317	0
8	CA	C	2006	1/1	0.86	0.16	125,125,125,125	0
8	CA	G	2006	1/1	0.87	0.06	95,95,95,95	0
8	CA	E	2005	1/1	0.87	0.08	176,176,176,176	0
7	NAG	G	3880	14/15	0.90	0.29	84,176,236,252	0
8	CA	E	2006	1/1	0.90	0.13	137,137,137,137	0
7	NAG	E	3880	14/15	0.90	0.18	80,160,189,194	0
7	NAG	A	3880	14/15	0.91	0.18	105,143,196,220	0
8	CA	E	2007	1/1	0.91	0.12	188,188,188,188	0
8	CA	A	2007	1/1	0.92	0.08	181,181,181,181	0
7	NAG	C	3880	14/15	0.92	0.23	60,171,245,293	0
8	CA	G	2005	1/1	0.94	0.04	139,139,139,139	0
8	CA	F	2002	1/1	0.94	0.11	578,578,578,578	0
9	MG	A	2009	1/1	0.95	0.11	367,367,367,367	0

6.5 Other polymers [i](#)

There are no such residues in this entry.