



Full wwPDB X-ray Structure Validation Report

May 16, 2020 – 01:43 am BST

PDB ID : 3K5C
Title : Human BACE-1 complex with NB-216
Authors : Rondeau, J.-M.
Deposited on : 2009-10-07
Resolution : 2.12 Å(reported)

This is a Full wwPDB X-ray Structure Validation Report for a publicly released PDB entry.

We welcome your comments at validation@mail.wwpdb.org

A user guide is available at

<https://www.wwpdb.org/validation/2017/XrayValidationReportHelp>

with specific help available everywhere you see the  symbol.

The following versions of software and data (see [references](#) ) were used in the production of this report:

MolProbity : 4.02b-467
Mogul : 1.8.5 (274361), CSD as541be (2020)
Xtriage (Phenix) : 1.13
EDS : 2.11
buster-report : 1.1.7 (2018)
Percentile statistics : 20191225.v01 (using entries in the PDB archive December 25th 2019)
Refmac : 5.8.0158
CCP4 : 7.0.044 (Gargrove)
Ideal geometry (proteins) : Engh & Huber (2001)
Ideal geometry (DNA, RNA) : Parkinson et al. (1996)
Validation Pipeline (wwPDB-VP) : 2.11

1 Overall quality at a glance

The following experimental techniques were used to determine the structure:

X-RAY DIFFRACTION

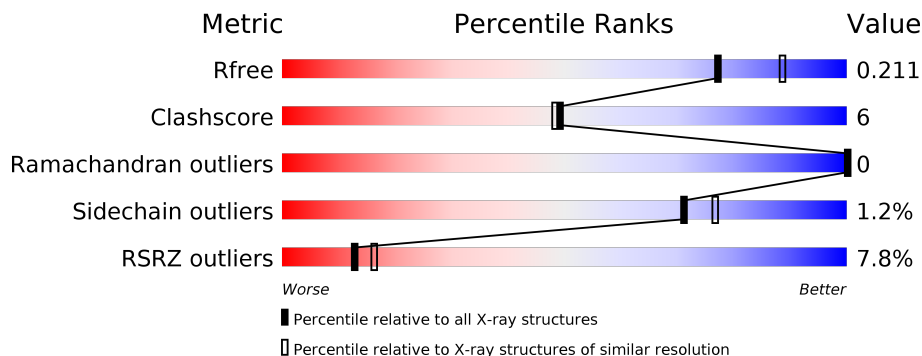

The reported resolution of this entry is 2.12 Å.

Percentile scores (ranging between 0-100) for global validation metrics of the entry are shown in the following graphic. The table shows the number of entries on which the scores are based.



Metric	Whole archive (#Entries)	Similar resolution (#Entries, resolution range(Å))
R_{free}	130704	6241 (2.14-2.10)
Clashscore	141614	6778 (2.14-2.10)
Ramachandran outliers	138981	6705 (2.14-2.10)
Sidechain outliers	138945	6706 (2.14-2.10)
RSRZ outliers	127900	6112 (2.14-2.10)

The table below summarises the geometric issues observed across the polymeric chains and their fit to the electron density. The red, orange, yellow and green segments on the lower bar indicate the fraction of residues that contain outliers for ≥ 3 , 2, 1 and 0 types of geometric quality criteria respectively. A grey segment represents the fraction of residues that are not modelled. The numeric value for each fraction is indicated below the corresponding segment, with a dot representing fractions $\leq 5\%$. The upper red bar (where present) indicates the fraction of residues that have poor fit to the electron density. The numeric value is given above the bar.

Mol	Chain	Length	Quality of chain
1	A	402	 6% 80% 13% • 6%
1	B	402	 9% 83% 10% • 6%
1	C	402	 7% 79% 15% 5%

2 Entry composition

There are 3 unique types of molecules in this entry. The entry contains 9519 atoms, of which 0 are hydrogens and 0 are deuteriums.

In the tables below, the ZeroOcc column contains the number of atoms modelled with zero occupancy, the AltConf column contains the number of residues with at least one atom in alternate conformation and the Trace column contains the number of residues modelled with at most 2 atoms.

- Molecule 1 is a protein called Beta-secretase 1.

Mol	Chain	Residues	Atoms					ZeroOcc	AltConf	Trace
			Total	C	N	O	S			
1	A	377	2966	1898	493	561	14	0	0	0
1	B	377	2966	1898	493	561	14	0	0	0
1	C	381	2993	1917	497	565	14	0	0	0

There are 6 discrepancies between the modelled and reference sequences:

Chain	Residue	Modelled	Actual	Comment	Reference
A	33P	GLY	-	expression tag	UNP P56817
A	34P	PRO	-	expression tag	UNP P56817
B	33P	GLY	-	expression tag	UNP P56817
B	34P	PRO	-	expression tag	UNP P56817
C	33P	GLY	-	expression tag	UNP P56817
C	34P	PRO	-	expression tag	UNP P56817

- Molecule 2 is (4S)-4-[(1R)-1-hydroxy-2-({1-[3-(1-methylethyl)phenyl]cyclopropyl}amino)ethyl]-19-(methoxymethyl)-11-oxa-3,16-diazatricyclo[15.3.1.1 6,10]docosa-1(21),6(22),7,9,17,19-hexaen-2-one (three-letter code: 0BI) (formula: C₃₅H₄₅N₃O₄).

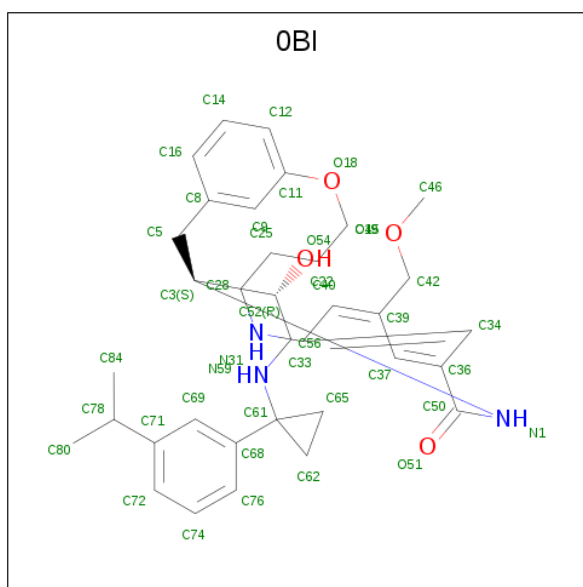

Mol	Chain	Residues	Atoms				ZeroOcc	AltConf
			Total	C	N	O		
2	A	1	42	35	3	4	0	0
2	B	1	42	35	3	4	0	0
2	C	1	42	35	3	4	0	0

- Molecule 3 is water.

Mol	Chain	Residues	Atoms		ZeroOcc	AltConf
			Total	O		
3	A	162	162	162	0	0
3	B	135	135	135	0	0
3	C	171	171	171	0	0

3 Residue-property plots [i](#)

These plots are drawn for all protein, RNA and DNA chains in the entry. The first graphic for a chain summarises the proportions of the various outlier classes displayed in the second graphic. The second graphic shows the sequence view annotated by issues in geometry and electron density. Residues are color-coded according to the number of geometric quality criteria for which they contain at least one outlier: green = 0, yellow = 1, orange = 2 and red = 3 or more. A red dot above a residue indicates a poor fit to the electron density ($RSRZ > 2$). Stretches of 2 or more consecutive residues without any outlier are shown as a green connector. Residues present in the sample, but not in the model, are shown in grey.

- Molecule 1: Beta-secretase 1

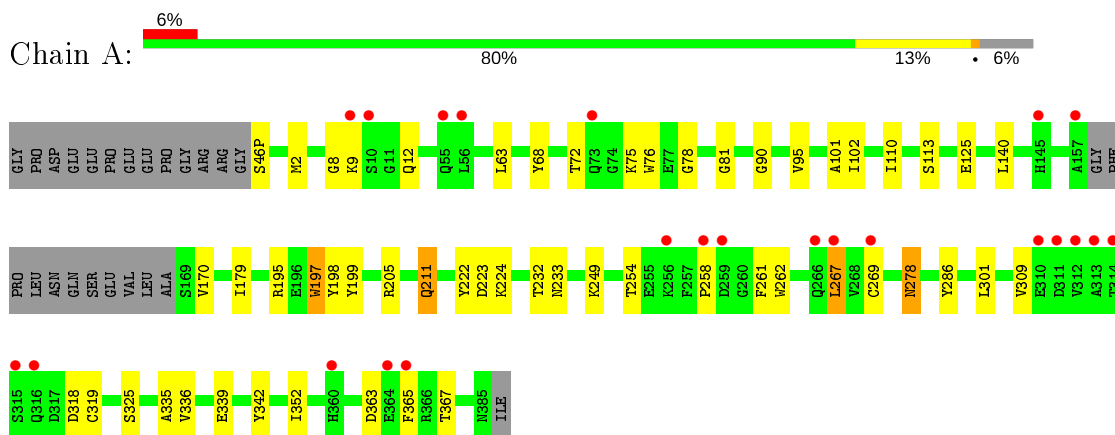

- Molecule 1: Beta-secretase 1

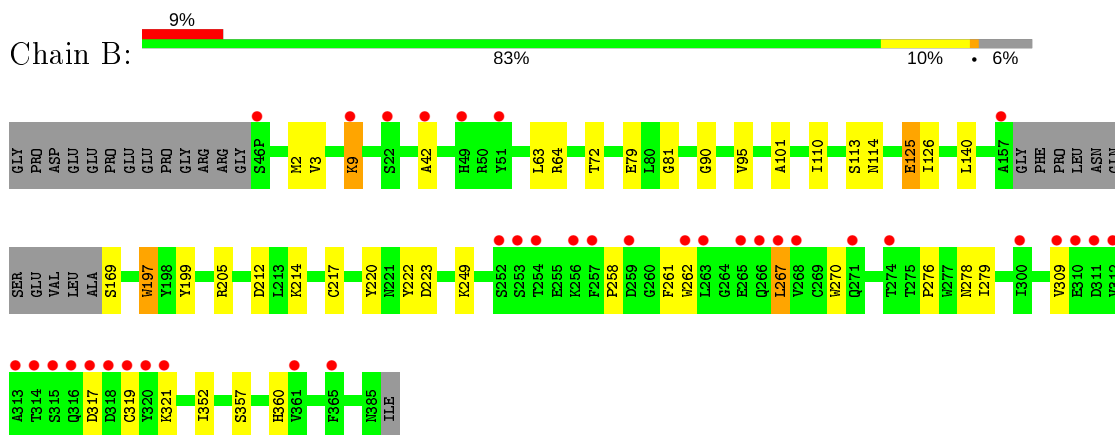

- Molecule 1: Beta-secretase 1

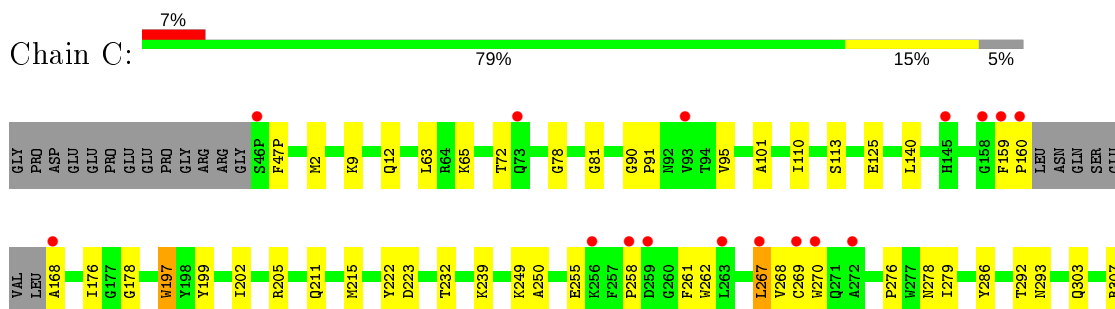

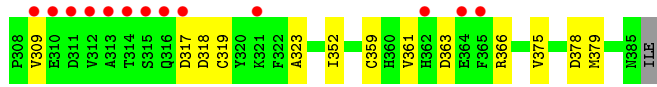

4 Data and refinement statistics

Property	Value	Source
Space group	P 1 21 1	Depositor
Cell constants a, b, c, α , β , γ	81.75Å 103.19Å 100.14Å 90.00° 104.44° 90.00°	Depositor
Resolution (Å)	70.55 – 2.12 70.55 – 2.12	Depositor EDS
% Data completeness (in resolution range)	99.6 (70.55-2.12) 99.8 (70.55-2.12)	Depositor EDS
R_{merge}	0.05	Depositor
R_{sym}	0.05	Depositor
$\langle I/\sigma(I) \rangle$ ¹	3.46 (at 2.12Å)	Xtrriage
Refinement program	CNS, CNX 2005	Depositor
R, R_{free}	0.200 , 0.220 0.191 , 0.211	Depositor DCC
R_{free} test set	9103 reflections (9.99%)	wwPDB-VP
Wilson B-factor (Å ²)	41.1	Xtrriage
Anisotropy	0.221	Xtrriage
Bulk solvent k_{sol} (e/Å ³), B_{sol} (Å ²)	0.37 , 44.6	EDS
L-test for twinning ²	$\langle L \rangle = 0.48$, $\langle L^2 \rangle = 0.31$	Xtrriage
Estimated twinning fraction	No twinning to report.	Xtrriage
F_o, F_c correlation	0.96	EDS
Total number of atoms	9519	wwPDB-VP
Average B, all atoms (Å ²)	48.0	wwPDB-VP

Xtrriage's analysis on translational NCS is as follows: *The largest off-origin peak in the Patterson function is 3.77% of the height of the origin peak. No significant pseudotranslation is detected.*

¹ Intensities estimated from amplitudes.

² Theoretical values of $\langle |L| \rangle$, $\langle L^2 \rangle$ for acentric reflections are 0.5, 0.333 respectively for untwinned datasets, and 0.375, 0.2 for perfectly twinned datasets.

5 Model quality [i](#)

5.1 Standard geometry [i](#)

Bond lengths and bond angles in the following residue types are not validated in this section: 0BI

The Z score for a bond length (or angle) is the number of standard deviations the observed value is removed from the expected value. A bond length (or angle) with $|Z| > 5$ is considered an outlier worth inspection. RMSZ is the root-mean-square of all Z scores of the bond lengths (or angles).

Mol	Chain	Bond lengths		Bond angles	
		RMSZ	# Z >5	RMSZ	# Z >5
1	A	0.30	0/3041	0.47	0/4133
1	B	0.30	0/3041	0.47	0/4133
1	C	0.30	0/3070	0.48	0/4173
All	All	0.30	0/9152	0.48	0/12439

There are no bond length outliers.

There are no bond angle outliers.

There are no chirality outliers.

There are no planarity outliers.

5.2 Too-close contacts [i](#)

In the following table, the Non-H and H(model) columns list the number of non-hydrogen atoms and hydrogen atoms in the chain respectively. The H(added) column lists the number of hydrogen atoms added and optimized by MolProbity. The Clashes column lists the number of clashes within the asymmetric unit, whereas Symm-Clashes lists symmetry related clashes.

Mol	Chain	Non-H	H(model)	H(added)	Clashes	Symm-Clashes
1	A	2966	0	2875	36	0
1	B	2966	0	2875	32	0
1	C	2993	0	2899	43	0
2	A	42	0	45	1	0
2	B	42	0	45	1	0
2	C	42	0	45	2	0
3	A	162	0	0	2	0
3	B	135	0	0	0	0
3	C	171	0	0	1	0
All	All	9519	0	8784	106	0

The all-atom clashscore is defined as the number of clashes found per 1000 atoms (including hydrogen atoms). The all-atom clashscore for this structure is 6.

All (106) close contacts within the same asymmetric unit are listed below, sorted by their clash magnitude.

Atom-1	Atom-2	Interatomic distance (Å)	Clash overlap (Å)
1:A:367:THR:H	1:C:211:GLN:HE22	1.19	0.85
1:A:267:LEU:HD23	1:A:267:LEU:H	1.48	0.74
1:B:267:LEU:HD23	1:B:267:LEU:H	1.55	0.72
1:C:255:GLU:OE1	1:C:270:TRP:NE1	2.26	0.69
1:C:267:LEU:H	1:C:267:LEU:HD23	1.58	0.69
1:B:9:LYS:HD2	1:B:9:LYS:N	2.10	0.66
1:A:46(P):SER:HB3	3:A:539:HOH:O	1.96	0.65
1:C:268:VAL:O	1:C:319:CYS:HA	1.97	0.63
1:C:9:LYS:HD3	1:C:168:ALA:HB3	1.79	0.63
1:A:367:THR:H	1:C:211:GLN:NE2	1.95	0.63
1:B:205:ARG:NH2	1:B:212:ASP:HB2	2.14	0.62
1:A:72:THR:HB	2:A:387:OBI:H37	1.81	0.62
1:A:267:LEU:HD12	1:A:319:CYS:HB3	1.85	0.59
1:A:233:ASN:HD22	1:A:325:SER:HG	1.51	0.57
1:B:2:MET:HG2	1:B:90:GLY:HA2	1.88	0.56
1:C:267:LEU:HD13	1:C:309:VAL:CG2	2.36	0.56
1:A:68:TYR:CD1	1:B:3:VAL:HG11	2.41	0.55
1:C:65:LYS:HD3	3:C:540:HOH:O	2.07	0.55
1:A:254:THR:HG23	1:C:278:ASN:OD1	2.07	0.55
1:C:269:CYS:HA	1:C:318:ASP:O	2.07	0.55
1:A:258:PRO:O	1:A:261:PHE:HB3	2.07	0.55
1:C:258:PRO:O	1:C:261:PHE:HB3	2.07	0.55
1:C:72:THR:HB	2:C:387:OBI:H37	1.88	0.54
1:A:335:ALA:O	1:A:339:GLU:HG3	2.07	0.54
1:B:9:LYS:NZ	1:B:114:ASN:HB2	2.23	0.53
1:A:2:MET:HG2	1:A:90:GLY:HA2	1.90	0.53
1:C:303:GLN:HB2	1:C:361:VAL:HG11	1.91	0.53
1:B:276:PRO:O	1:B:279:ILE:HG12	2.09	0.53
1:A:278:ASN:H	1:A:278:ASN:HD22	1.57	0.52
1:C:110:ILE:HB	1:C:113:SER:HB3	1.91	0.52
1:B:110:ILE:HB	1:B:113:SER:HB3	1.91	0.52
1:B:357:SER:O	1:B:360:HIS:HB3	2.10	0.52
1:A:110:ILE:HB	1:A:113:SER:HB3	1.92	0.52
1:C:159:PHE:HB3	1:C:160:PRO:HD2	1.92	0.52
1:B:258:PRO:O	1:B:261:PHE:HB3	2.09	0.51
1:B:270:TRP:O	1:B:317:ASP:HB3	2.10	0.51
1:B:267:LEU:HD13	1:B:309:VAL:CG2	2.41	0.51

Continued on next page...

Continued from previous page...

Atom-1	Atom-2	Interatomic distance (Å)	Clash overlap (Å)
1:C:2:MET:HG2	1:C:90:GLY:HA2	1.93	0.51
1:C:12:GLN:OE1	1:C:113:SER:HA	2.11	0.50
1:C:276:PRO:O	1:C:279:ILE:HG12	2.12	0.49
1:C:363:ASP:HB3	1:C:366:ARG:O	2.13	0.49
1:C:293:ASN:HA	1:C:375:VAL:HA	1.93	0.49
1:B:63:LEU:HG	1:B:81:GLY:HA2	1.95	0.48
1:A:125:GLU:OE2	1:A:195:ARG:NH2	2.44	0.48
1:B:267:LEU:HD13	1:B:309:VAL:HG21	1.95	0.48
1:C:125:GLU:HG2	1:C:197:TRP:HB3	1.95	0.48
1:B:199:TYR:HB3	1:B:352:ILE:HD11	1.94	0.48
1:A:199:TYR:HB3	1:A:352:ILE:HD11	1.95	0.48
1:C:267:LEU:HD13	1:C:309:VAL:HG21	1.96	0.48
1:C:249:LYS:HE2	1:C:262:TRP:CD1	2.49	0.47
1:B:72:THR:HB	2:B:387:OBI:H37	1.97	0.47
1:A:249:LYS:HE2	1:A:262:TRP:CD1	2.50	0.46
1:C:267:LEU:N	1:C:267:LEU:HD23	2.26	0.46
1:C:199:TYR:HB3	1:C:352:ILE:HD11	1.96	0.46
1:A:222:TYR:HA	1:A:223:ASP:HA	1.65	0.45
1:C:270:TRP:O	1:C:317:ASP:HB3	2.16	0.45
1:B:212:ASP:O	1:B:214:LYS:HG3	2.16	0.45
1:A:211:GLN:HB2	3:A:455:HOH:O	2.16	0.45
1:C:202:ILE:CD1	1:C:379:MET:HG3	2.46	0.45
1:C:63:LEU:HG	1:C:81:GLY:HA2	1.99	0.45
1:A:267:LEU:HD13	1:A:309:VAL:CG2	2.47	0.44
1:A:232:THR:O	1:A:336:VAL:HG13	2.17	0.44
1:A:211:GLN:HB2	1:A:211:GLN:HE21	1.65	0.44
1:C:359:CYS:SG	1:C:359:CYS:O	2.76	0.44
1:C:267:LEU:HD13	1:C:309:VAL:HG23	1.98	0.44
1:A:95:VAL:HG11	1:A:140:LEU:HA	2.00	0.44
1:B:9:LYS:N	1:B:9:LYS:CD	2.81	0.44
1:C:202:ILE:HD11	1:C:379:MET:HG3	2.00	0.44
1:B:249:LYS:HE2	1:B:262:TRP:CD1	2.52	0.43
1:C:205:ARG:HB3	1:C:286:TYR:HB2	2.00	0.43
1:C:307:ARG:HG3	1:C:323:ALA:HB2	1.99	0.43
1:C:215:MET:HE1	1:C:239:LYS:HG2	2.00	0.43
1:B:125:GLU:HG3	1:B:125:GLU:O	2.17	0.43
1:B:222:TYR:HA	1:B:223:ASP:HA	1.63	0.43
1:C:95:VAL:HG11	1:C:140:LEU:HA	2.00	0.43
1:C:78:GLY:HA3	1:C:101:ALA:O	2.18	0.43
1:A:9:LYS:HD2	1:A:12:GLN:OE1	2.19	0.42
1:A:301:LEU:HD13	1:A:363:ASP:HB2	2.02	0.42

Continued on next page...

Continued from previous page...

Atom-1	Atom-2	Interatomic distance (Å)	Clash overlap (Å)
1:B:267:LEU:HD23	1:B:267:LEU:N	2.28	0.42
1:C:65:LYS:HE2	1:C:65:LYS:HB2	1.95	0.42
1:A:8:GLY:O	1:A:170:VAL:HG22	2.19	0.42
1:C:292:THR:HG21	1:C:378:ASP:HB3	2.00	0.42
1:B:217:CYS:HA	1:B:220:TYR:CD1	2.55	0.42
1:C:232:THR:OG1	2:C:387:0BI:H28	2.20	0.42
1:A:269:CYS:HA	1:A:318:ASP:O	2.20	0.41
1:B:309:VAL:HG11	1:B:321:LYS:HG3	2.02	0.41
1:A:205:ARG:HB3	1:A:286:TYR:HB2	2.02	0.41
1:B:95:VAL:HG11	1:B:140:LEU:HA	2.02	0.41
1:A:365:PHE:CG	1:C:250:ALA:HB1	2.56	0.41
1:C:91:PRO:HD3	1:C:176:ILE:HB	2.03	0.41
1:B:42:ALA:CB	1:B:101:ALA:HB1	2.51	0.41
1:B:126:ILE:HG23	1:B:197:TRP:HB2	2.03	0.41
1:B:278:ASN:H	1:B:278:ASN:HD22	1.69	0.41
1:C:47(P):PHE:CZ	1:C:178:GLY:HA3	2.56	0.41
1:A:179:ILE:HG23	1:A:342:TYR:HE2	1.86	0.41
1:A:63:LEU:HG	1:A:81:GLY:HA2	2.02	0.41
1:B:9:LYS:HZ1	1:B:114:ASN:HB2	1.84	0.41
1:B:267:LEU:HD12	1:B:319:CYS:HB3	2.02	0.41
1:C:222:TYR:HA	1:C:223:ASP:HA	1.63	0.41
1:A:78:GLY:HA3	1:A:101:ALA:O	2.21	0.41
1:A:197:TRP:N	1:A:197:TRP:CD1	2.89	0.41
1:B:64:ARG:HA	1:B:79:GLU:OE2	2.20	0.41
1:A:8:GLY:C	1:A:170:VAL:HG22	2.42	0.40
1:A:76:TRP:HB2	1:A:102:ILE:HG23	2.03	0.40
1:B:197:TRP:CD1	1:B:197:TRP:N	2.89	0.40
1:A:198:TYR:CE2	1:A:224:LYS:HE3	2.56	0.40

There are no symmetry-related clashes.

5.3 Torsion angles [i](#)

5.3.1 Protein backbone [i](#)

In the following table, the Percentiles column shows the percent Ramachandran outliers of the chain as a percentile score with respect to all X-ray entries followed by that with respect to entries of similar resolution.

The Analysed column shows the number of residues for which the backbone conformation was analysed, and the total number of residues.

Mol	Chain	Analysed	Favoured	Allowed	Outliers	Percentiles	
1	A	373/402 (93%)	365 (98%)	8 (2%)	0	100	100
1	B	373/402 (93%)	361 (97%)	12 (3%)	0	100	100
1	C	377/402 (94%)	363 (96%)	14 (4%)	0	100	100
All	All	1123/1206 (93%)	1089 (97%)	34 (3%)	0	100	100

There are no Ramachandran outliers to report.

5.3.2 Protein sidechains [i](#)

In the following table, the Percentiles column shows the percent sidechain outliers of the chain as a percentile score with respect to all X-ray entries followed by that with respect to entries of similar resolution.

The Analysed column shows the number of residues for which the sidechain conformation was analysed, and the total number of residues.

Mol	Chain	Analysed	Rotameric	Outliers	Percentiles	
1	A	322/342 (94%)	317 (98%)	5 (2%)	62	68
1	B	322/342 (94%)	317 (98%)	5 (2%)	62	68
1	C	324/342 (95%)	322 (99%)	2 (1%)	86	90
All	All	968/1026 (94%)	956 (99%)	12 (1%)	71	77

All (12) residues with a non-rotameric sidechain are listed below:

Mol	Chain	Res	Type
1	A	75	LYS
1	A	197	TRP
1	A	211	GLN
1	A	267	LEU
1	A	278	ASN
1	B	9	LYS
1	B	125	GLU
1	B	169	SER
1	B	197	TRP
1	B	267	LEU
1	C	197	TRP
1	C	267	LEU

Some sidechains can be flipped to improve hydrogen bonding and reduce clashes. All (9) such sidechains are listed below:

Mol	Chain	Res	Type
1	A	114	ASN
1	A	326	GLN
1	B	114	ASN
1	B	278	ASN
1	B	293	ASN
1	B	326	GLN
1	C	114	ASN
1	C	211	GLN
1	C	326	GLN

5.3.3 RNA [i](#)

There are no RNA molecules in this entry.

5.4 Non-standard residues in protein, DNA, RNA chains [i](#)

There are no non-standard protein/DNA/RNA residues in this entry.

5.5 Carbohydrates [i](#)

There are no carbohydrates in this entry.

5.6 Ligand geometry [i](#)

3 ligands are modelled in this entry.

In the following table, the Counts columns list the number of bonds (or angles) for which Mogul statistics could be retrieved, the number of bonds (or angles) that are observed in the model and the number of bonds (or angles) that are defined in the Chemical Component Dictionary. The Link column lists molecule types, if any, to which the group is linked. The Z score for a bond length (or angle) is the number of standard deviations the observed value is removed from the expected value. A bond length (or angle) with $|Z| > 2$ is considered an outlier worth inspection. RMSZ is the root-mean-square of all Z scores of the bond lengths (or angles).

Mol	Type	Chain	Res	Link	Bond lengths			Bond angles		
					Counts	RMSZ	# $ Z > 2$	Counts	RMSZ	# $ Z > 2$
2	0BI	A	387	-	42,46,46	1.37	2 (4%)	59,64,64	1.11	6 (10%)
2	0BI	C	387	-	42,46,46	1.40	4 (9%)	59,64,64	1.12	5 (8%)
2	0BI	B	387	-	42,46,46	1.38	3 (7%)	59,64,64	1.11	7 (11%)

In the following table, the Chirals column lists the number of chiral outliers, the number of chiral

centers analysed, the number of these observed in the model and the number defined in the Chemical Component Dictionary. Similar counts are reported in the Torsion and Rings columns. '-' means no outliers of that kind were identified.

Mol	Type	Chain	Res	Link	Chirals	Torsions	Rings
2	0BI	A	387	-	-	2/41/48/48	0/4/5/5
2	0BI	C	387	-	-	2/41/48/48	0/4/5/5
2	0BI	B	387	-	-	2/41/48/48	0/4/5/5

All (9) bond length outliers are listed below:

Mol	Chain	Res	Type	Atoms	Z	Observed(Å)	Ideal(Å)
2	C	387	0BI	C72-C71	2.39	1.42	1.39
2	B	387	0BI	C69-C71	2.29	1.42	1.39
2	C	387	0BI	C56-C52	2.22	1.55	1.52
2	B	387	0BI	C9-C11	2.18	1.42	1.38
2	C	387	0BI	C69-C71	2.17	1.42	1.39
2	A	387	0BI	C69-C71	2.16	1.42	1.39
2	B	387	0BI	C72-C71	2.11	1.42	1.39
2	A	387	0BI	C34-C33	2.05	1.42	1.39
2	C	387	0BI	C37-C36	2.03	1.42	1.39

All (18) bond angle outliers are listed below:

Mol	Chain	Res	Type	Atoms	Z	Observed(°)	Ideal(°)
2	C	387	0BI	C62-C61-N59	-3.99	113.42	117.30
2	A	387	0BI	C62-C61-N59	-3.67	113.72	117.30
2	B	387	0BI	C62-C61-N59	-3.62	113.78	117.30
2	B	387	0BI	C62-C61-C68	-3.57	114.06	118.78
2	A	387	0BI	C62-C61-C68	-3.52	114.13	118.78
2	C	387	0BI	C62-C61-C68	-3.28	114.44	118.78
2	A	387	0BI	C19-O18-C11	2.78	125.20	117.93
2	C	387	0BI	C19-O18-C11	2.76	125.13	117.93
2	B	387	0BI	C19-O18-C11	2.40	124.21	117.93
2	A	387	0BI	C3-N1-C50	2.35	127.29	123.01
2	A	387	0BI	C36-C50-N1	2.23	121.34	117.06
2	B	387	0BI	O54-C52-C56	-2.20	105.24	109.69
2	B	387	0BI	C36-C50-N1	2.18	121.24	117.06
2	C	387	0BI	C3-N1-C50	2.14	126.91	123.01
2	C	387	0BI	C36-C50-N1	2.13	121.15	117.06
2	B	387	0BI	C3-N1-C50	2.12	126.88	123.01
2	B	387	0BI	O51-C50-C36	-2.06	117.27	120.94
2	A	387	0BI	O51-C50-C36	-2.01	117.34	120.94

There are no chirality outliers.

All (6) torsion outliers are listed below:

Mol	Chain	Res	Type	Atoms
2	A	387	0BI	C39-C42-O45-C46
2	C	387	0BI	C39-C42-O45-C46
2	B	387	0BI	C39-C42-O45-C46
2	B	387	0BI	C22-C19-O18-C11
2	C	387	0BI	C22-C19-O18-C11
2	A	387	0BI	C22-C19-O18-C11

There are no ring outliers.

3 monomers are involved in 4 short contacts:

Mol	Chain	Res	Type	Clashes	Symm-Clashes
2	A	387	0BI	1	0
2	C	387	0BI	2	0
2	B	387	0BI	1	0

The following is a two-dimensional graphical depiction of Mogul quality analysis of bond lengths, bond angles, torsion angles, and ring geometry for all instances of the Ligand of Interest. In addition, ligands with molecular weight > 250 and outliers as shown on the validation Tables will also be included. For torsion angles, if less than 5% of the Mogul distribution of torsion angles is within 10 degrees of the torsion angle in question, then that torsion angle is considered an outlier. Any bond that is central to one or more torsion angles identified as an outlier by Mogul will be highlighted in the graph. For rings, the root-mean-square deviation (RMSD) between the ring in question and similar rings identified by Mogul is calculated over all ring torsion angles. If the average RMSD is greater than 60 degrees and the minimal RMSD between the ring in question and any Mogul-identified rings is also greater than 60 degrees, then that ring is considered an outlier. The outliers are highlighted in purple. The color gray indicates Mogul did not find sufficient equivalents in the CSD to analyse the geometry.

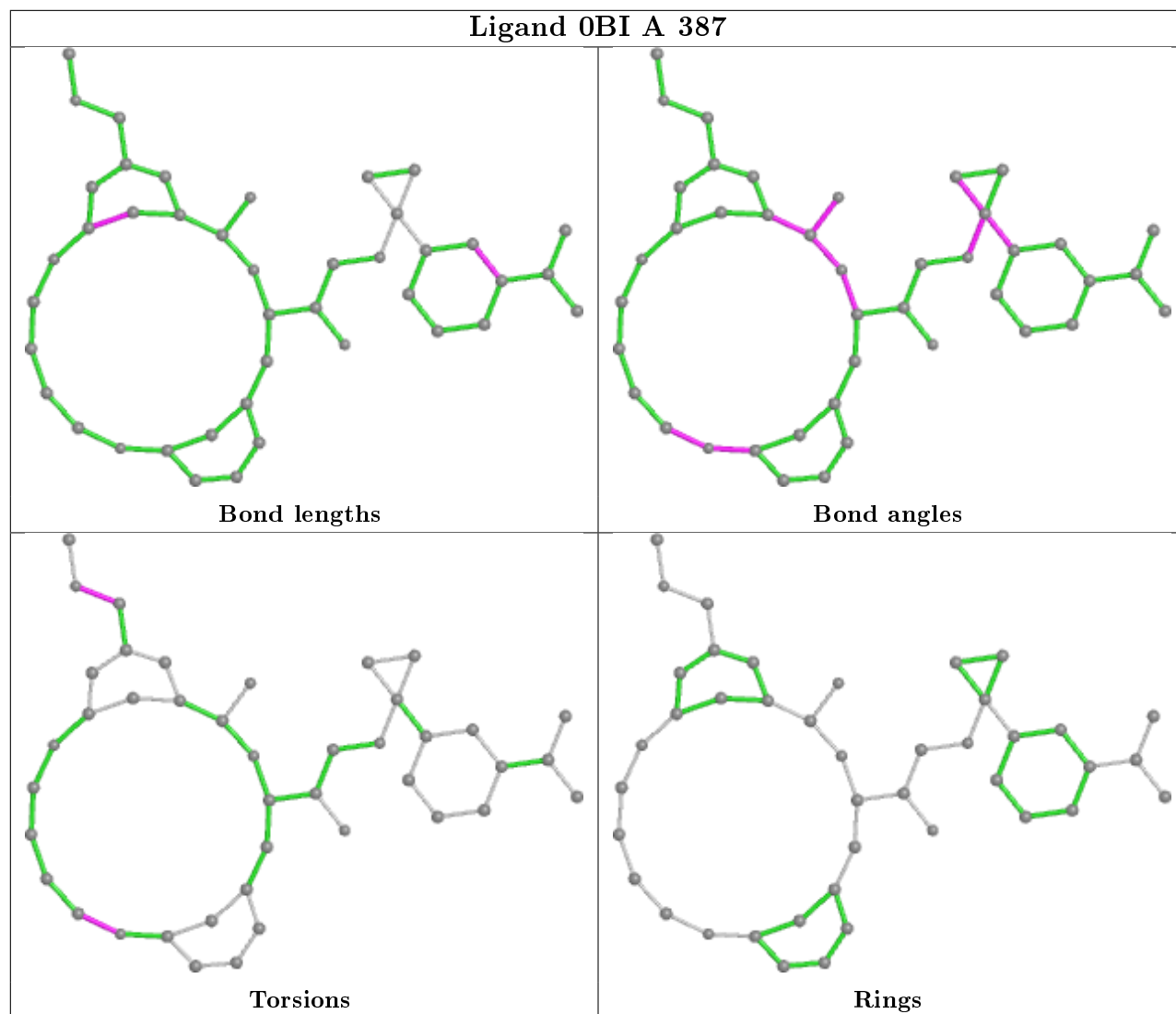

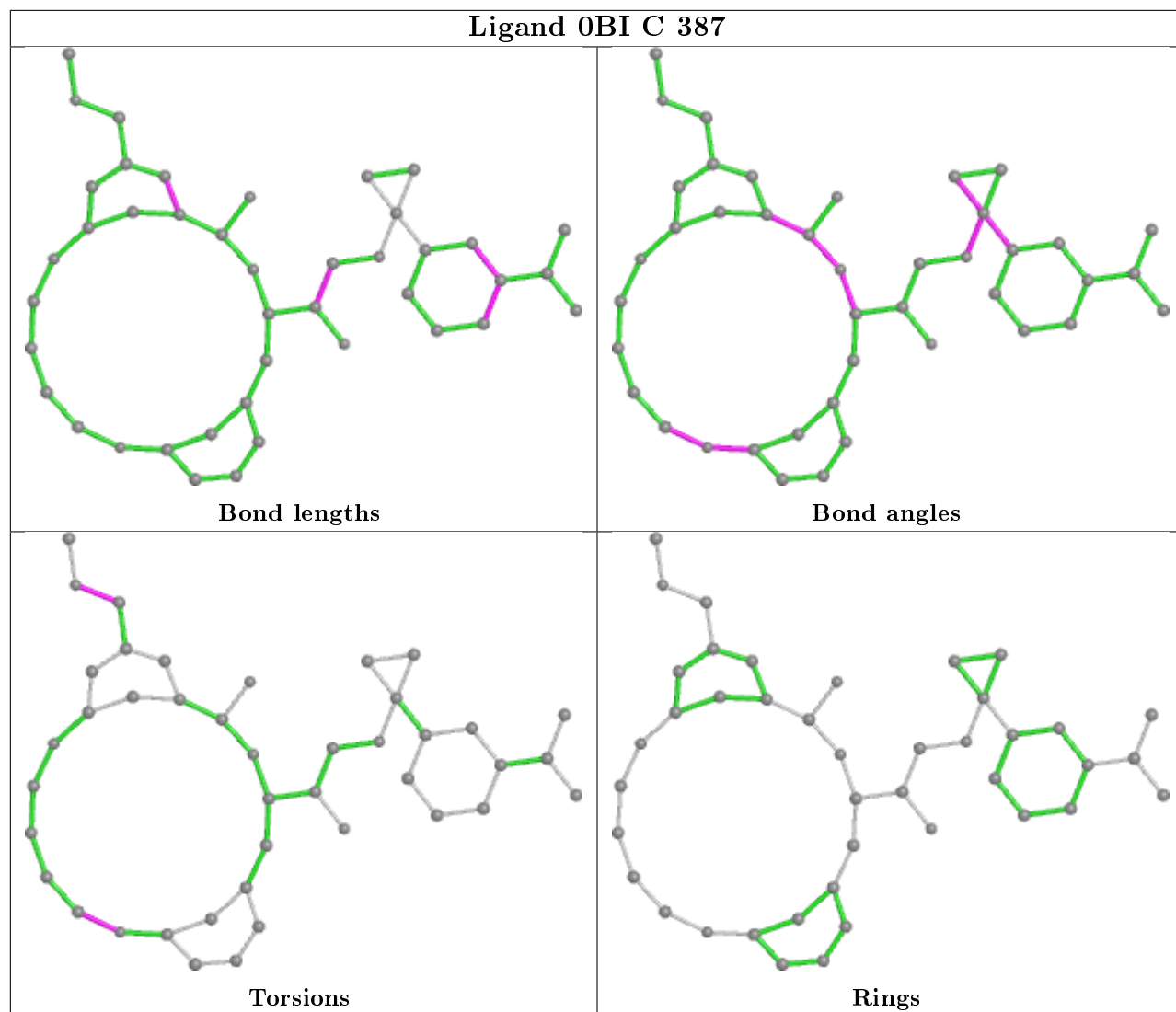

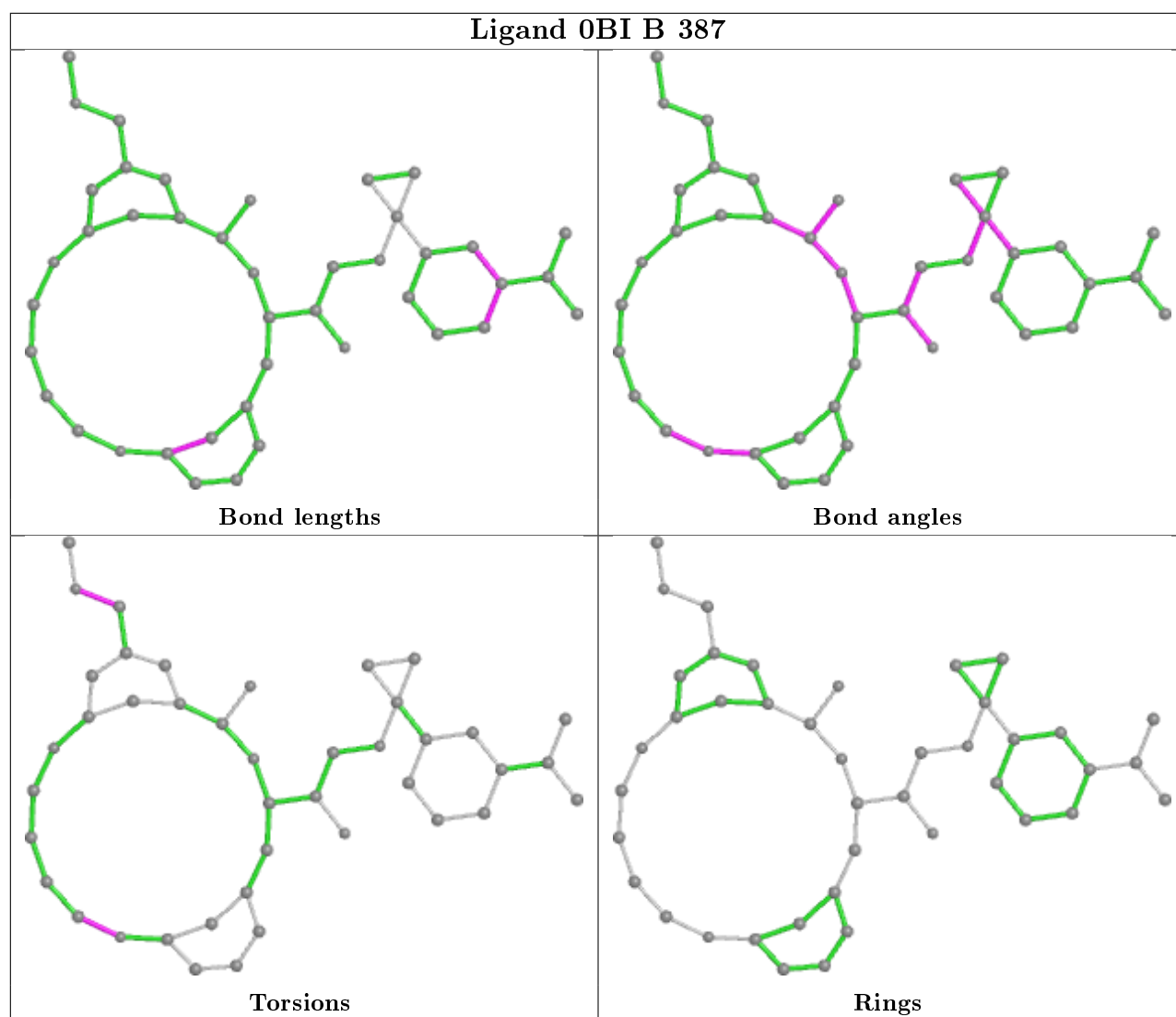

5.7 Other polymers [\(i\)](#)

There are no such residues in this entry.

5.8 Polymer linkage issues [\(i\)](#)

There are no chain breaks in this entry.

6 Fit of model and data [i](#)

6.1 Protein, DNA and RNA chains [i](#)

In the following table, the column labelled ‘#RSRZ > 2’ contains the number (and percentage) of RSRZ outliers, followed by percent RSRZ outliers for the chain as percentile scores relative to all X-ray entries and entries of similar resolution. The OWAB column contains the minimum, median, 95th percentile and maximum values of the occupancy-weighted average B-factor per residue. The column labelled ‘Q < 0.9’ lists the number of (and percentage) of residues with an average occupancy less than 0.9.

Mol	Chain	Analysed	<RSRZ>	#RSRZ>2	OWAB(Å ²)	Q<0.9
1	A	377/402 (93%)	0.63	23 (6%) 21 25	28, 44, 81, 116	0
1	B	377/402 (93%)	0.85	37 (9%) 7 9	27, 45, 85, 118	0
1	C	381/402 (94%)	0.71	29 (7%) 13 17	29, 44, 83, 116	0
All	All	1135/1206 (94%)	0.73	89 (7%) 13 16	27, 45, 84, 118	0

All (89) RSRZ outliers are listed below:

Mol	Chain	Res	Type	RSRZ
1	B	314	THR	16.4
1	C	312	VAL	13.5
1	B	312	VAL	13.4
1	C	158	GLY	10.4
1	A	312	VAL	10.2
1	B	313	ALA	9.0
1	A	314	THR	7.5
1	B	256	LYS	6.9
1	B	361	VAL	6.8
1	B	315	SER	6.5
1	C	310	GLU	6.4
1	C	315	SER	6.2
1	A	311	ASP	6.1
1	C	168	ALA	6.1
1	B	310	GLU	6.1
1	C	314	THR	6.0
1	C	313	ALA	5.1
1	C	160	PRO	5.1
1	A	313	ALA	5.0
1	B	257	PHE	4.9
1	C	365	PHE	4.9
1	A	157	ALA	4.8
1	C	159	PHE	4.7

Continued on next page...

Continued from previous page...

Mol	Chain	Res	Type	RSRZ
1	B	311	ASP	4.7
1	A	316	GLN	4.6
1	B	309	VAL	4.5
1	C	272	ALA	4.4
1	A	256	LYS	4.2
1	C	46(P)	SER	4.1
1	C	316	GLN	4.1
1	A	266	GLN	3.9
1	B	317	ASP	3.9
1	B	263	LEU	3.7
1	B	316	GLN	3.7
1	B	268	VAL	3.6
1	C	309	VAL	3.6
1	B	271	GLN	3.4
1	B	254	THR	3.4
1	B	365	PHE	3.4
1	B	266	GLN	3.4
1	C	145	HIS	3.3
1	B	318	ASP	3.3
1	B	319	CYS	3.3
1	B	157	ALA	3.3
1	B	262	TRP	3.2
1	C	311	ASP	3.1
1	C	256	LYS	3.1
1	B	267	LEU	3.0
1	A	310	GLU	3.0
1	A	315	SER	2.9
1	C	267	LEU	2.9
1	C	269	CYS	2.9
1	B	252	SER	2.8
1	B	49	HIS	2.8
1	B	265	GLU	2.8
1	B	46(P)	SER	2.8
1	B	321	LYS	2.7
1	B	22	SER	2.7
1	A	267	LEU	2.6
1	B	274	THR	2.6
1	B	9	LYS	2.5
1	A	9	LYS	2.5
1	B	320	TYR	2.4
1	A	258	PRO	2.4
1	C	362	HIS	2.3

Continued on next page...

Continued from previous page...

Mol	Chain	Res	Type	RSRZ
1	C	258	PRO	2.3
1	A	55	GLN	2.3
1	A	360	HIS	2.3
1	B	51	TYR	2.3
1	B	253	SER	2.3
1	A	269	CYS	2.2
1	B	259	ASP	2.2
1	A	73	GLN	2.2
1	A	365	PHE	2.2
1	B	42	ALA	2.2
1	A	10	SER	2.2
1	A	259	ASP	2.2
1	C	263	LEU	2.1
1	C	270	TRP	2.1
1	A	56	LEU	2.1
1	A	364	GLU	2.1
1	C	321	LYS	2.1
1	C	259	ASP	2.1
1	A	145	HIS	2.1
1	C	317	ASP	2.1
1	C	73	GLN	2.0
1	B	300	ILE	2.0
1	C	93	VAL	2.0
1	C	364	GLU	2.0

6.2 Non-standard residues in protein, DNA, RNA chains [i](#)

There are no non-standard protein/DNA/RNA residues in this entry.

6.3 Carbohydrates [i](#)

There are no carbohydrates in this entry.

6.4 Ligands [i](#)

In the following table, the Atoms column lists the number of modelled atoms in the group and the number defined in the chemical component dictionary. The B-factors column lists the minimum, median, 95th percentile and maximum values of B factors of atoms in the group. The column labelled 'Q< 0.9' lists the number of atoms with occupancy less than 0.9.

Mol	Type	Chain	Res	Atoms	RSCC	RSR	B-factors(\AA^2)	Q<0.9
2	0BI	A	387	42/42	0.94	0.16	30,36,44,59	0
2	0BI	C	387	42/42	0.96	0.15	31,36,44,59	0
2	0BI	B	387	42/42	0.96	0.16	31,37,43,58	0

The following is a graphical depiction of the model fit to experimental electron density of all instances of the Ligand of Interest. In addition, ligands with molecular weight > 250 and outliers as shown on the geometry validation Tables will also be included. Each fit is shown from different orientation to approximate a three-dimensional view.

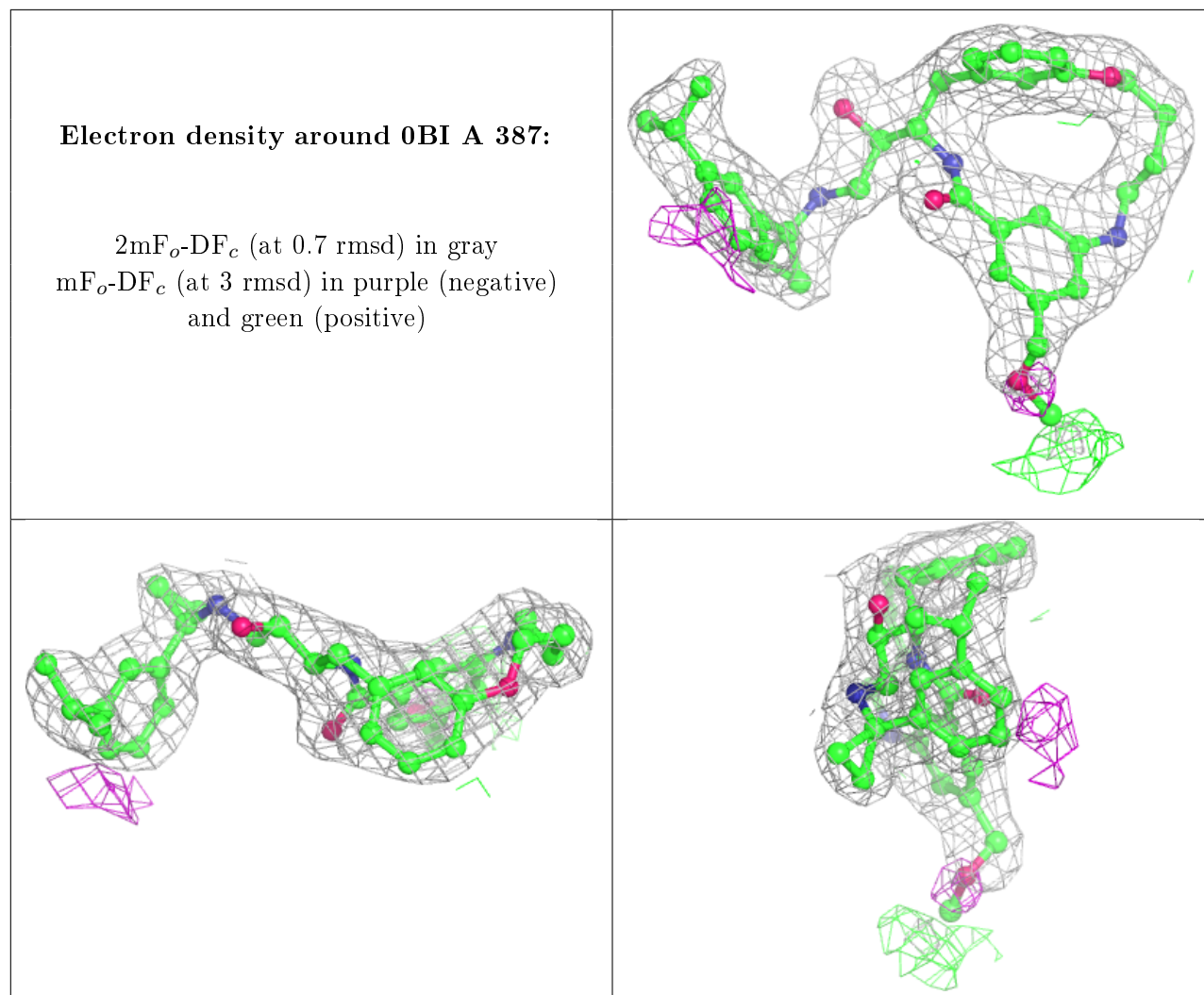

Electron density around 0BI C 387:

$2mF_o-DF_c$ (at 0.7 rmsd) in gray
 mF_o-DF_c (at 3 rmsd) in purple (negative)
and green (positive)

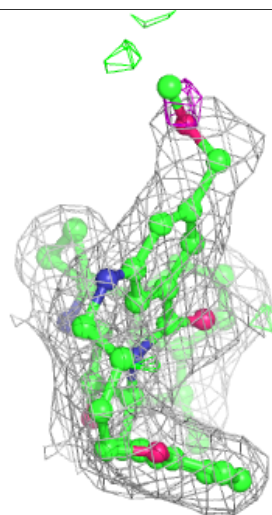
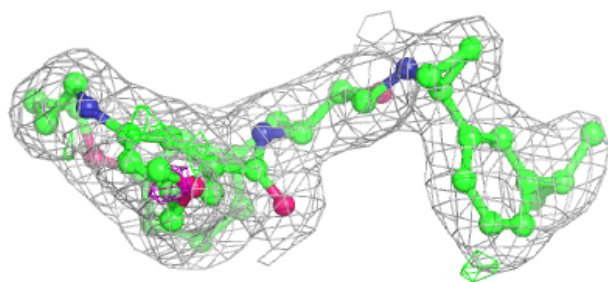
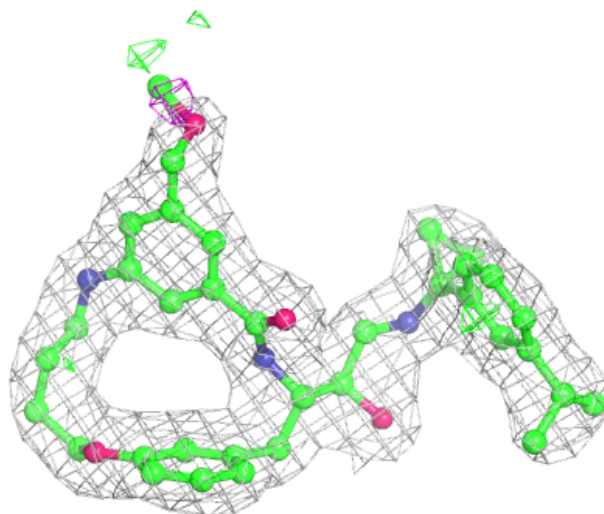

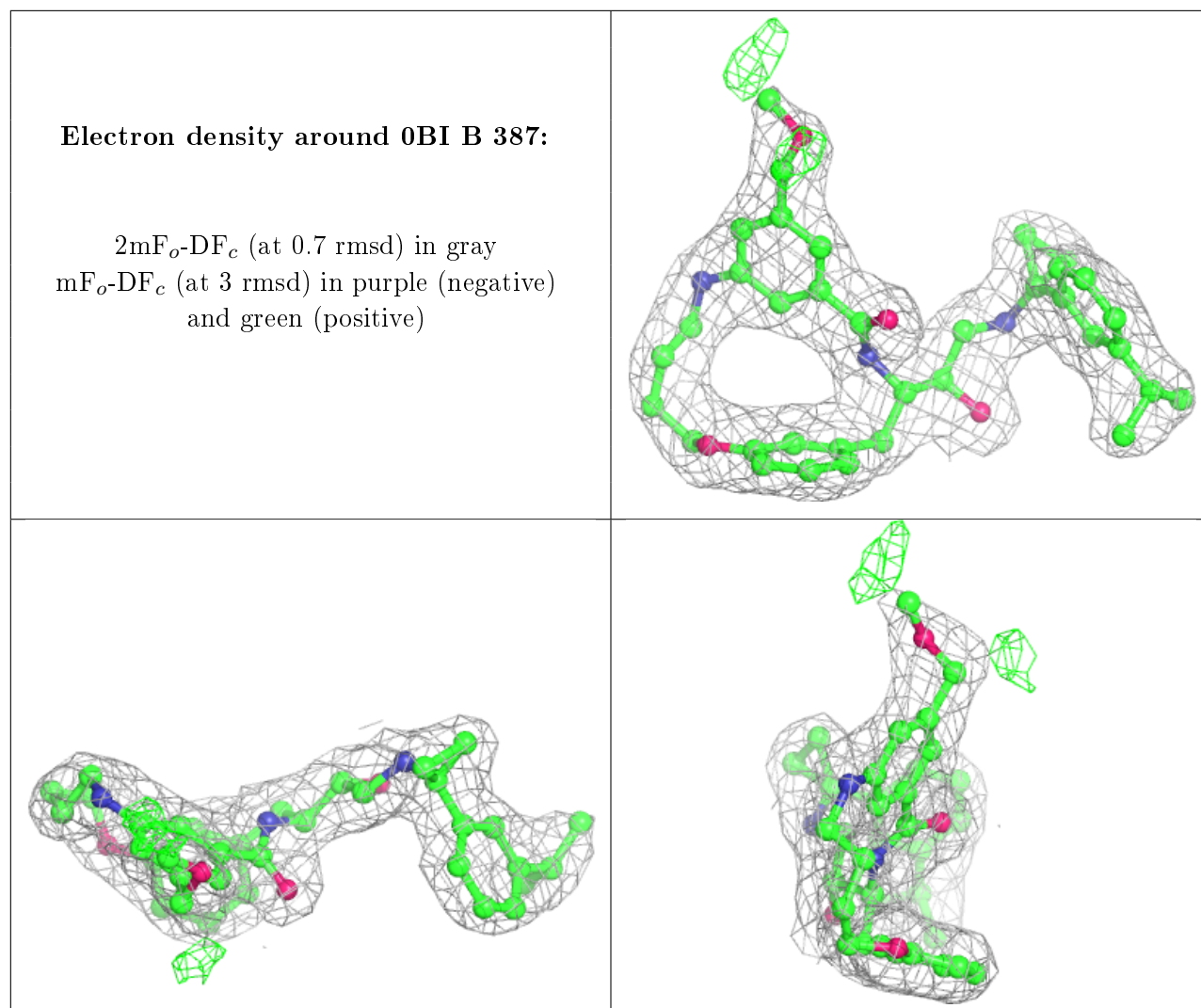

6.5 Other polymers [i](#)

There are no such residues in this entry.