



Full wwPDB X-ray Structure Validation Report ⓘ

Aug 27, 2023 – 05:27 AM EDT

PDB ID : 3IKH
Title : Crystal structure of Ribokinase in Complex with ATP and glycerol in the active site from *Klebsiella pneumoniae*
Authors : Satyanarayana, L.; Burley, S.K.; Swaminathan, S.; New York SGX Research Center for Structural Genomics (NYSGXRC)
Deposited on : 2009-08-05
Resolution : 1.88 Å(reported)

This is a Full wwPDB X-ray Structure Validation Report for a publicly released PDB entry.

We welcome your comments at validation@mail.wwpdb.org

A user guide is available at

<https://www.wwpdb.org/validation/2017/XrayValidationReportHelp>

with specific help available everywhere you see the ⓘ symbol.

The types of validation reports are described at

<http://www.wwpdb.org/validation/2017/FAQs#types>.

The following versions of software and data (see [references ⓘ](#)) were used in the production of this report:

MolProbity : 4.02b-467
Mogul : 1.8.5 (274361), CSD as541be (2020)
Xtriage (Phenix) : 1.13
EDS : 2.35
buster-report : 1.1.7 (2018)
Percentile statistics : 20191225.v01 (using entries in the PDB archive December 25th 2019)
Refmac : 5.8.0158
CCP4 : 7.0.044 (Gargrove)
Ideal geometry (proteins) : Engh & Huber (2001)
Ideal geometry (DNA, RNA) : Parkinson et al. (1996)
Validation Pipeline (wwPDB-VP) : 2.35

1 Overall quality at a glance

The following experimental techniques were used to determine the structure:

X-RAY DIFFRACTION

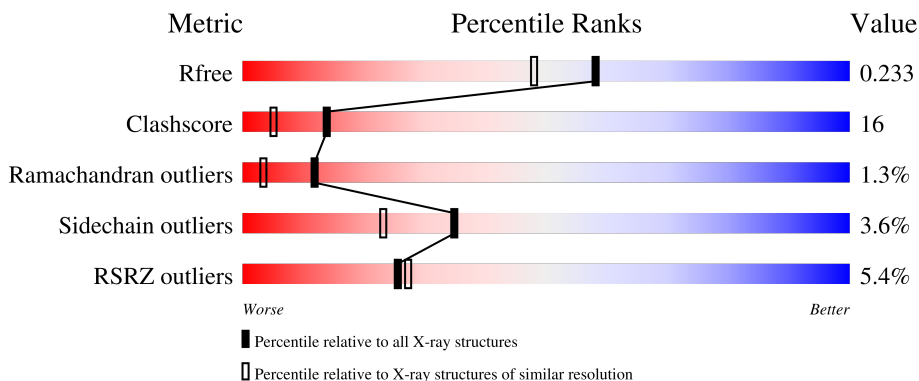

The reported resolution of this entry is 1.88 Å.

Percentile scores (ranging between 0-100) for global validation metrics of the entry are shown in the following graphic. The table shows the number of entries on which the scores are based.

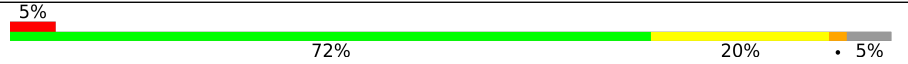
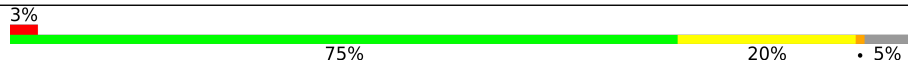

Metric	Whole archive (#Entries)	Similar resolution (#Entries, resolution range(Å))
R_{free}	130704	9470 (1.90-1.86)
Clashscore	141614	10282 (1.90-1.86)
Ramachandran outliers	138981	10152 (1.90-1.86)
Sidechain outliers	138945	10152 (1.90-1.86)
RSRZ outliers	127900	9303 (1.90-1.86)

The table below summarises the geometric issues observed across the polymeric chains and their fit to the electron density. The red, orange, yellow and green segments of the lower bar indicate the fraction of residues that contain outliers for ≥ 3 , 2, 1 and 0 types of geometric quality criteria respectively. A grey segment represents the fraction of residues that are not modelled. The numeric value for each fraction is indicated below the corresponding segment, with a dot representing fractions $\leq 5\%$. The upper red bar (where present) indicates the fraction of residues that have poor fit to the electron density. The numeric value is given above the bar.

Mol	Chain	Length	Quality of chain
1	A	299	 6% 63% 29% 5% 5%
1	B	299	 5% 72% 20% 5% 5%
1	C	299	 3% 75% 20% 5% 5%
1	D	299	 7% 71% 21% 5% 5%

2 Entry composition i

There are 4 unique types of molecules in this entry. The entry contains 9000 atoms, of which 0 are hydrogens and 0 are deuteriums.

In the tables below, the ZeroOcc column contains the number of atoms modelled with zero occupancy, the AltConf column contains the number of residues with at least one atom in alternate conformation and the Trace column contains the number of residues modelled with at most 2 atoms.

- Molecule 1 is a protein called Carbohydrate kinase.

Mol	Chain	Residues	Atoms						ZeroOcc	AltConf	Trace
			Total	C	N	O	S	Se			
1	A	286	2127	1336	373	410	3	5	0	0	0
1	B	283	2109	1327	370	404	3	5	0	0	0
1	C	285	2121	1333	372	408	3	5	0	0	0
1	D	286	2127	1336	373	410	3	5	0	0	0

There are 44 discrepancies between the modelled and reference sequences:

Chain	Residue	Modelled	Actual	Comment	Reference
A	-3	MSE	-	expression tag	UNP A6T989
A	-2	SER	-	expression tag	UNP A6T989
A	-1	LEU	-	expression tag	UNP A6T989
A	290	GLU	-	expression tag	UNP A6T989
A	291	GLY	-	expression tag	UNP A6T989
A	292	HIS	-	expression tag	UNP A6T989
A	293	HIS	-	expression tag	UNP A6T989
A	294	HIS	-	expression tag	UNP A6T989
A	295	HIS	-	expression tag	UNP A6T989
A	296	HIS	-	expression tag	UNP A6T989
A	297	HIS	-	expression tag	UNP A6T989
B	-3	MSE	-	expression tag	UNP A6T989
B	-2	SER	-	expression tag	UNP A6T989
B	-1	LEU	-	expression tag	UNP A6T989
B	290	GLU	-	expression tag	UNP A6T989
B	291	GLY	-	expression tag	UNP A6T989
B	292	HIS	-	expression tag	UNP A6T989
B	293	HIS	-	expression tag	UNP A6T989
B	294	HIS	-	expression tag	UNP A6T989
B	295	HIS	-	expression tag	UNP A6T989
B	296	HIS	-	expression tag	UNP A6T989

Continued on next page...

Continued from previous page...

Chain	Residue	Modelled	Actual	Comment	Reference
B	297	HIS	-	expression tag	UNP A6T989
C	-3	MSE	-	expression tag	UNP A6T989
C	-2	SER	-	expression tag	UNP A6T989
C	-1	LEU	-	expression tag	UNP A6T989
C	290	GLU	-	expression tag	UNP A6T989
C	291	GLY	-	expression tag	UNP A6T989
C	292	HIS	-	expression tag	UNP A6T989
C	293	HIS	-	expression tag	UNP A6T989
C	294	HIS	-	expression tag	UNP A6T989
C	295	HIS	-	expression tag	UNP A6T989
C	296	HIS	-	expression tag	UNP A6T989
C	297	HIS	-	expression tag	UNP A6T989
D	-3	MSE	-	expression tag	UNP A6T989
D	-2	SER	-	expression tag	UNP A6T989
D	-1	LEU	-	expression tag	UNP A6T989
D	290	GLU	-	expression tag	UNP A6T989
D	291	GLY	-	expression tag	UNP A6T989
D	292	HIS	-	expression tag	UNP A6T989
D	293	HIS	-	expression tag	UNP A6T989
D	294	HIS	-	expression tag	UNP A6T989
D	295	HIS	-	expression tag	UNP A6T989
D	296	HIS	-	expression tag	UNP A6T989
D	297	HIS	-	expression tag	UNP A6T989

- Molecule 2 is ADENOSINE-5'-TRIPHOSPHATE (three-letter code: ATP) (formula: $C_{10}H_{16}N_5O_{13}P_3$).

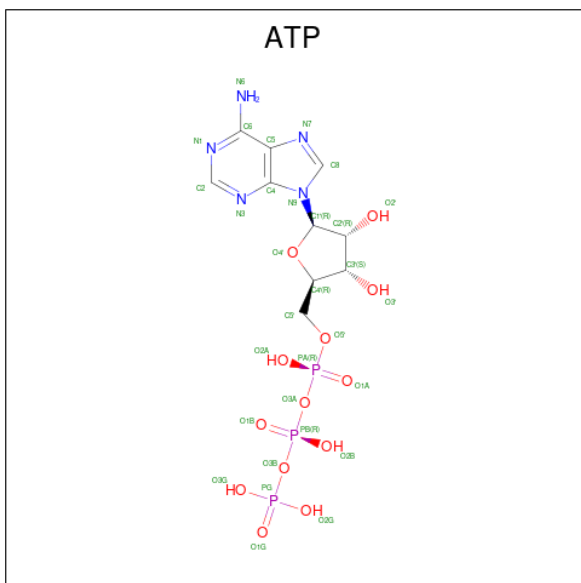

Mol	Chain	Residues	Atoms					ZeroOcc	AltConf
			Total	C	N	O	P		
2	A	1	Total 31	C 10	N 5	O 13	P 3	0	0
2	B	1	Total 31	C 10	N 5	O 13	P 3	0	0
2	C	1	Total 31	C 10	N 5	O 13	P 3	0	0
2	D	1	Total 31	C 10	N 5	O 13	P 3	0	0

- Molecule 3 is GLYCEROL (three-letter code: GOL) (formula: C₃H₈O₃).

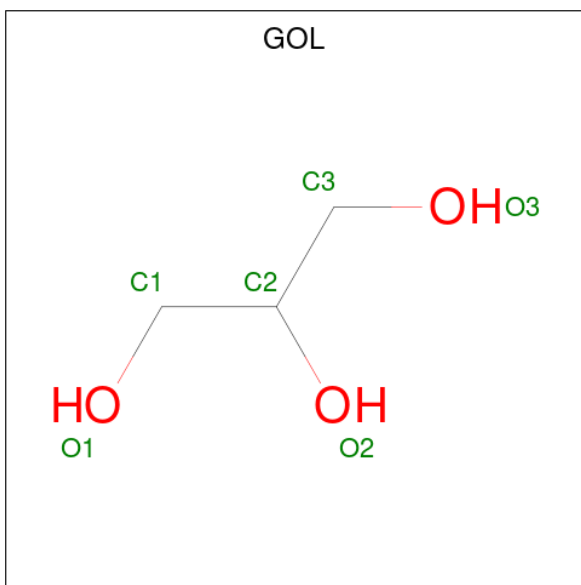

Mol	Chain	Residues	Atoms			ZeroOcc	AltConf
			Total	C	O		
3	C	1	Total 6	C 3	O 3	0	0
3	D	1	Total 6	C 3	O 3	0	0

- Molecule 4 is water.

Mol	Chain	Residues	Atoms		ZeroOcc	AltConf
			Total	O		
4	A	95	Total 95	O 95	0	0
4	B	109	Total 109	O 109	0	0
4	C	101	Total 101	O 101	0	0
4	D	75	Total 75	O 75	0	0

3 Residue-property plots [i](#)

These plots are drawn for all protein, RNA, DNA and oligosaccharide chains in the entry. The first graphic for a chain summarises the proportions of the various outlier classes displayed in the second graphic. The second graphic shows the sequence view annotated by issues in geometry and electron density. Residues are color-coded according to the number of geometric quality criteria for which they contain at least one outlier: green = 0, yellow = 1, orange = 2 and red = 3 or more. A red dot above a residue indicates a poor fit to the electron density ($RSRZ > 2$). Stretches of 2 or more consecutive residues without any outlier are shown as a green connector. Residues present in the sample, but not in the model, are shown in grey.

- Molecule 1: Carbohydrate kinase

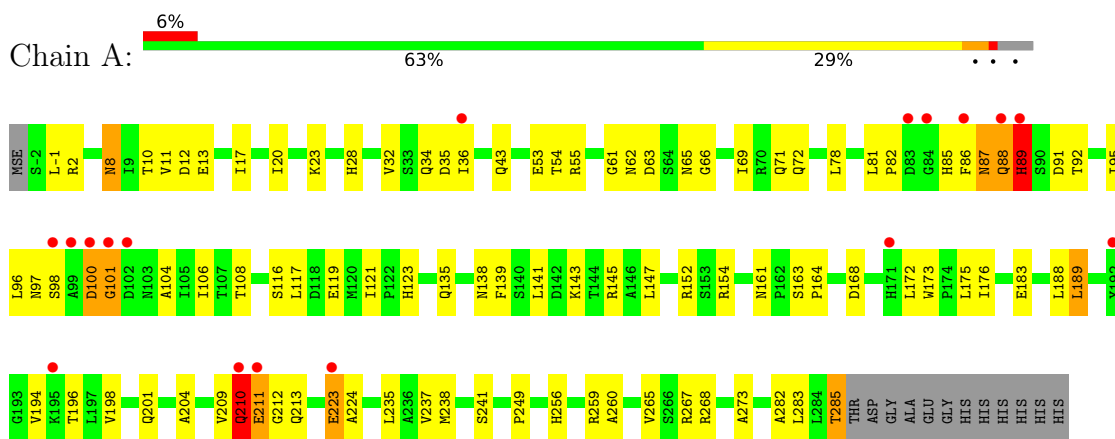

- Molecule 1: Carbohydrate kinase

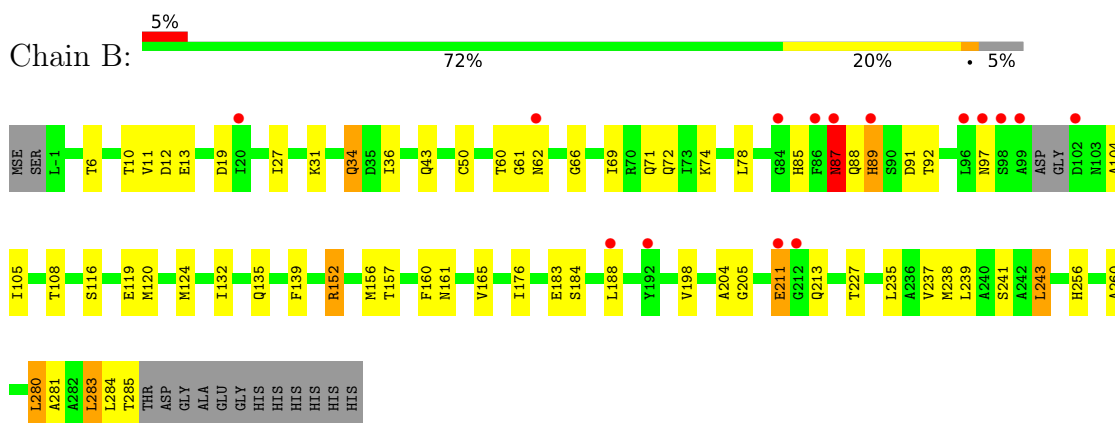

- Molecule 1: Carbohydrate kinase

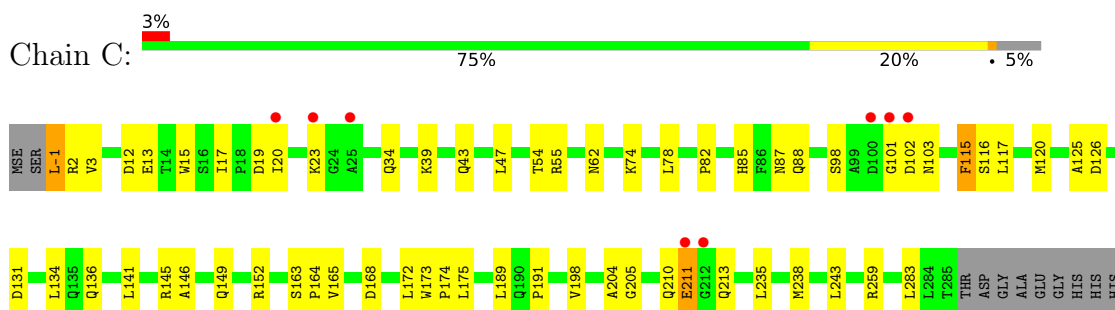

HIS
HIS
HIS

● Molecule 1: Carbohydrate kinase

Chain D:  7% 71% 21%

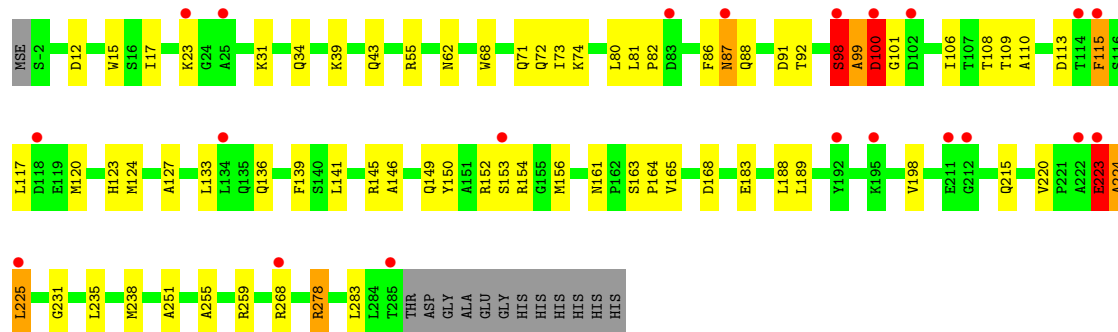

4 Data and refinement statistics

Property	Value	Source
Space group	P 1 21 1	Depositor
Cell constants a, b, c, α , β , γ	54.33Å 106.35Å 122.06Å 90.00° 99.51° 90.00°	Depositor
Resolution (Å)	37.54 – 1.88 37.54 – 1.88	Depositor EDS
% Data completeness (in resolution range)	95.3 (37.54-1.88) 95.5 (37.54-1.88)	Depositor EDS
R_{merge}	(Not available)	Depositor
R_{sym}	0.09	Depositor
$\langle I/\sigma(I) \rangle$ ¹	1.85 (at 1.88Å)	Xtrriage
Refinement program	CNS 1.1	Depositor
R, R_{free}	0.220 , 0.240 0.212 , 0.233	Depositor DCC
R_{free} test set	4275 reflections (3.86%)	wwPDB-VP
Wilson B-factor (Å ²)	26.9	Xtrriage
Anisotropy	0.452	Xtrriage
Bulk solvent k_{sol} (e/Å ³), B_{sol} (Å ²)	0.37 , 44.0	EDS
L-test for twinning ²	$\langle L \rangle = 0.48$, $\langle L^2 \rangle = 0.31$	Xtrriage
Estimated twinning fraction	No twinning to report.	Xtrriage
F_o, F_c correlation	0.94	EDS
Total number of atoms	9000	wwPDB-VP
Average B, all atoms (Å ²)	32.0	wwPDB-VP

Xtrriage's analysis on translational NCS is as follows: *The largest off-origin peak in the Patterson function is 3.59% of the height of the origin peak. No significant pseudotranslation is detected.*

¹Intensities estimated from amplitudes.

²Theoretical values of $\langle |L| \rangle$, $\langle L^2 \rangle$ for acentric reflections are 0.5, 0.333 respectively for untwinned datasets, and 0.375, 0.2 for perfectly twinned datasets.

5 Model quality [i](#)

5.1 Standard geometry [i](#)

Bond lengths and bond angles in the following residue types are not validated in this section: ATP, GOL

The Z score for a bond length (or angle) is the number of standard deviations the observed value is removed from the expected value. A bond length (or angle) with $|Z| > 5$ is considered an outlier worth inspection. RMSZ is the root-mean-square of all Z scores of the bond lengths (or angles).

Mol	Chain	Bond lengths		Bond angles	
		RMSZ	# Z >5	RMSZ	# Z >5
1	A	0.37	0/2161	0.71	2/2939 (0.1%)
1	B	0.33	0/2142	0.65	2/2912 (0.1%)
1	C	0.32	0/2155	0.61	0/2931
1	D	0.31	0/2161	0.63	0/2939
All	All	0.33	0/8619	0.65	4/11721 (0.0%)

There are no bond length outliers.

All (4) bond angle outliers are listed below:

Mol	Chain	Res	Type	Atoms	Z	Observed(°)	Ideal(°)
1	A	89	HIS	N-CA-C	9.68	137.13	111.00
1	A	210	GLN	N-CA-C	7.19	130.41	111.00
1	B	87	ASN	N-CA-C	6.68	129.03	111.00
1	B	78	LEU	CA-CB-CG	5.29	127.48	115.30

There are no chirality outliers.

There are no planarity outliers.

5.2 Too-close contacts [i](#)

In the following table, the Non-H and H(model) columns list the number of non-hydrogen atoms and hydrogen atoms in the chain respectively. The H(added) column lists the number of hydrogen atoms added and optimized by MolProbity. The Clashes column lists the number of clashes within the asymmetric unit, whereas Symm-Clashes lists symmetry-related clashes.

Mol	Chain	Non-H	H(model)	H(added)	Clashes	Symm-Clashes
1	A	2127	0	2127	98	0
1	B	2109	0	2114	72	0
1	C	2121	0	2122	46	0

Continued on next page...

Continued from previous page...

Mol	Chain	Non-H	H(model)	H(added)	Clashes	Symm-Clashes
1	D	2127	0	2127	66	0
2	A	31	0	12	0	0
2	B	31	0	12	0	0
2	C	31	0	12	0	0
2	D	31	0	12	1	0
3	C	6	0	8	0	0
3	D	6	0	8	0	0
4	A	95	0	0	5	0
4	B	109	0	0	7	0
4	C	101	0	0	7	0
4	D	75	0	0	2	0
All	All	9000	0	8554	271	0

The all-atom clashscore is defined as the number of clashes found per 1000 atoms (including hydrogen atoms). The all-atom clashscore for this structure is 16.

All (271) close contacts within the same asymmetric unit are listed below, sorted by their clash magnitude.

Atom-1	Atom-2	Interatomic distance (Å)	Clash overlap (Å)
1:B:66:GLY:HA2	1:B:89:HIS:CE1	1.96	1.01
1:A:209:VAL:O	1:A:210:GLN:HB2	1.65	0.94
1:A:55:ARG:HD3	1:A:81:LEU:HD12	1.48	0.93
1:B:165:VAL:HG21	1:B:188:LEU:HD23	1.51	0.93
1:A:87:ASN:O	1:A:88:GLN:HB2	1.69	0.92
1:A:223:GLU:CD	1:A:223:GLU:H	1.71	0.91
1:A:61:GLY:H	1:A:89:HIS:CD2	1.90	0.89
1:B:69:ILE:HD12	1:B:89:HIS:NE2	1.93	0.84
1:B:88:GLN:O	1:B:89:HIS:HB2	1.76	0.83
1:A:210:GLN:C	1:A:212:GLY:H	1.81	0.81
1:A:66:GLY:HA2	1:A:89:HIS:NE2	1.96	0.80
1:D:92:THR:H	1:D:108:THR:HG22	1.45	0.80
1:D:165:VAL:HG21	1:D:188:LEU:HD23	1.64	0.79
1:D:225:LEU:HD21	1:D:268:ARG:HE	1.48	0.78
1:A:86:PHE:C	1:A:87:ASN:OD1	2.22	0.76
1:A:88:GLN:O	1:A:89:HIS:HB2	1.85	0.76
1:A:188:LEU:HD12	1:A:188:LEU:O	1.85	0.76
1:A:69:ILE:HD12	1:A:89:HIS:HE1	1.50	0.76
1:A:87:ASN:O	1:A:88:GLN:CB	2.32	0.76
1:A:196:THR:HG21	1:A:249:PRO:HG2	1.66	0.76
1:A:141:LEU:HD22	1:A:168:ASP:HB3	1.67	0.76
1:A:101:GLY:N	1:C:23:LYS:HD2	2.01	0.75

Continued on next page...

Continued from previous page...

Atom-1	Atom-2	Interatomic distance (Å)	Clash overlap (Å)
1:A:154:ARG:HD2	4:A:367:HOH:O	1.85	0.75
1:A:89:HIS:HB3	4:A:307:HOH:O	1.86	0.74
1:A:8:ASN:H	1:A:8:ASN:HD22	1.34	0.74
1:A:194:VAL:O	1:A:210:GLN:HG2	1.87	0.74
1:B:88:GLN:O	1:B:89:HIS:CB	2.37	0.73
1:B:66:GLY:CA	1:B:89:HIS:CE1	2.72	0.73
1:D:92:THR:H	1:D:108:THR:CG2	2.00	0.73
1:C:141:LEU:HD22	1:C:168:ASP:HB3	1.69	0.72
1:A:135:GLN:HE22	1:A:147:LEU:HD12	1.56	0.71
1:A:66:GLY:CA	1:A:89:HIS:NE2	2.53	0.71
1:D:124:MSE:HE2	1:D:156:MSE:SE	2.41	0.70
1:D:39:LYS:HB3	1:D:136:GLN:HG2	1.72	0.70
1:D:62:ASN:HD22	1:D:87:ASN:HA	1.56	0.70
1:B:61:GLY:H	1:B:89:HIS:CE1	2.10	0.70
1:B:12:ASP:OD1	1:B:92:THR:HG22	1.93	0.69
1:C:-1:LEU:HD12	1:C:2:ARG:N	2.07	0.69
1:B:124:MSE:HE2	1:B:156:MSE:SE	2.43	0.68
1:B:61:GLY:H	1:B:89:HIS:HD1	1.41	0.68
1:B:19:ASP:HA	1:B:97:ASN:CG	2.15	0.67
1:C:141:LEU:HD11	1:C:172:LEU:HD11	1.76	0.67
1:A:224:ALA:HA	1:A:265:VAL:HG12	1.76	0.67
1:A:210:GLN:C	1:A:212:GLY:N	2.47	0.67
1:A:223:GLU:HG3	4:A:386:HOH:O	1.95	0.66
1:A:88:GLN:O	1:A:89:HIS:CB	2.44	0.66
1:B:62:ASN:HB3	1:B:85:HIS:HD2	1.60	0.66
1:B:241:SER:OG	1:B:256:HIS:HD2	1.78	0.66
1:D:255:ALA:O	1:D:259:ARG:HD3	1.97	0.65
1:A:12:ASP:OD1	1:A:92:THR:HG22	1.96	0.65
1:A:223:GLU:CD	1:A:223:GLU:N	2.49	0.65
1:D:225:LEU:HD22	1:D:268:ARG:HG2	1.78	0.64
1:A:55:ARG:HD3	1:A:81:LEU:CD1	2.25	0.64
1:C:125:ALA:HA	4:C:375:HOH:O	1.96	0.64
1:A:223:GLU:N	1:A:223:GLU:OE2	2.31	0.64
1:D:82:PRO:HD3	1:D:115:PHE:CZ	2.32	0.64
1:A:96:LEU:HD12	4:A:392:HOH:O	1.98	0.64
1:D:225:LEU:CD2	1:D:268:ARG:HE	2.10	0.64
1:A:224:ALA:HA	1:A:265:VAL:CG1	2.28	0.64
1:D:55:ARG:HD3	1:D:81:LEU:CD1	2.28	0.64
1:C:-1:LEU:CD1	1:C:131:ASP:HA	2.28	0.63
1:A:87:ASN:OD1	1:A:87:ASN:N	2.30	0.63
1:B:19:ASP:HA	1:B:97:ASN:ND2	2.14	0.63

Continued on next page...

Continued from previous page...

Atom-1	Atom-2	Interatomic distance (Å)	Clash overlap (Å)
1:A:183:GLU:HG2	1:A:201:GLN:HG2	1.81	0.63
1:A:188:LEU:HG	1:A:189:LEU:HD13	1.80	0.63
1:B:19:ASP:HB2	1:B:97:ASN:ND2	2.14	0.63
1:A:61:GLY:N	1:A:89:HIS:CD2	2.66	0.62
1:A:63:ASP:OD1	1:A:89:HIS:CD2	2.53	0.62
1:A:69:ILE:HD12	1:A:89:HIS:CE1	2.34	0.62
1:C:17:ILE:O	1:C:98:SER:HA	2.00	0.62
1:A:183:GLU:CG	1:A:201:GLN:HG2	2.29	0.62
1:B:283:LEU:HD23	1:B:284:LEU:N	2.14	0.62
1:A:54:THR:O	1:A:78:LEU:HD12	1.99	0.61
1:A:100:ASP:OD2	1:C:23:LYS:HD3	2.00	0.61
1:B:124:MSE:HE3	1:B:156:MSE:HE1	1.82	0.61
1:B:108:THR:HG21	1:D:31:LYS:HG3	1.83	0.61
1:B:204:ALA:HB1	4:B:345:HOH:O	2.00	0.61
1:A:11:VAL:O	1:A:91:ASP:HB2	2.00	0.60
1:D:141:LEU:HG	1:D:145:ARG:HH12	1.66	0.60
1:D:145:ARG:HH11	1:D:145:ARG:HB2	1.66	0.60
1:C:141:LEU:CD1	1:C:172:LEU:HD11	2.31	0.60
1:A:63:ASP:OD2	1:A:89:HIS:HB2	2.02	0.60
1:B:10:THR:HB	1:B:91:ASP:HA	1.83	0.59
1:C:13:GLU:OE2	1:C:34:GLN:NE2	2.34	0.59
1:D:43:GLN:NE2	1:D:136:GLN:HE21	2.00	0.59
1:A:241:SER:OG	1:A:256:HIS:HD2	1.86	0.59
1:A:82:PRO:HB3	1:A:123:HIS:CE1	2.37	0.59
1:B:60:THR:HB	1:B:89:HIS:HE1	1.67	0.58
1:D:223:GLU:O	1:D:224:ALA:CB	2.51	0.58
1:D:141:LEU:HD22	1:D:168:ASP:HB3	1.86	0.58
1:B:66:GLY:HA2	1:B:89:HIS:HE1	1.63	0.58
1:D:55:ARG:HD3	1:D:81:LEU:HD12	1.85	0.58
1:B:104:ALA:C	1:B:105:ILE:HD12	2.24	0.58
1:B:105:ILE:HD12	1:B:105:ILE:N	2.19	0.58
1:C:145:ARG:O	1:C:149:GLN:HG3	2.04	0.58
1:B:27:ILE:HD11	1:D:106:ILE:HG12	1.84	0.58
1:D:225:LEU:HD13	1:D:268:ARG:HG3	1.86	0.58
1:A:97:ASN:HB3	1:A:100:ASP:HB2	1.86	0.57
1:A:101:GLY:H	1:C:23:LYS:HD2	1.68	0.57
1:A:196:THR:HG21	1:A:249:PRO:CG	2.34	0.57
1:D:98:SER:O	1:D:99:ALA:HB2	2.04	0.57
1:D:62:ASN:ND2	1:D:87:ASN:HA	2.19	0.57
1:D:120:MSE:HE1	1:D:139:PHE:CZ	2.40	0.57
1:B:61:GLY:N	1:B:89:HIS:ND1	2.47	0.57

Continued on next page...

Continued from previous page...

Atom-1	Atom-2	Interatomic distance (Å)	Clash overlap (Å)
1:A:10:THR:HB	1:A:91:ASP:HA	1.87	0.57
1:B:124:MSE:CE	1:B:156:MSE:SE	3.03	0.56
1:A:69:ILE:CD1	1:A:89:HIS:HE1	2.18	0.56
1:B:204:ALA:C	4:B:345:HOH:O	2.42	0.56
1:C:152:ARG:HD2	1:C:175:LEU:HD22	1.88	0.56
1:B:61:GLY:N	1:B:89:HIS:HD1	2.04	0.56
1:A:117:LEU:O	1:A:121:ILE:HD13	2.07	0.55
1:A:63:ASP:OD2	1:A:89:HIS:CB	2.55	0.55
1:B:19:ASP:HB2	1:B:97:ASN:HD21	1.70	0.55
1:D:150:TYR:OH	1:D:154:ARG:NH1	2.40	0.55
1:B:71:GLN:HA	1:B:74:LYS:HE2	1.88	0.55
1:A:36:ILE:HD11	1:A:72:GLN:HB2	1.90	0.54
1:A:62:ASN:HB3	1:A:85:HIS:HD2	1.71	0.54
1:D:220:VAL:HG21	1:D:259:ARG:HD2	1.90	0.54
1:D:223:GLU:O	1:D:224:ALA:HB3	2.07	0.53
1:B:60:THR:HB	1:B:89:HIS:CE1	2.44	0.53
1:A:282:ALA:O	1:A:285:THR:HG22	2.09	0.53
1:D:17:ILE:O	1:D:99:ALA:HB2	2.09	0.53
1:A:28:HIS:HE1	4:C:307:HOH:O	1.92	0.52
1:D:115:PHE:HB3	1:D:120:MSE:HE3	1.92	0.52
1:C:55:ARG:NH1	1:C:126:ASP:OD2	2.42	0.52
1:B:211:GLU:OE1	1:B:213:GLN:HG2	2.09	0.52
1:B:183:GLU:HG2	1:B:184:SER:N	2.24	0.52
1:D:152:ARG:O	1:D:153:SER:CB	2.58	0.51
1:C:198:VAL:HG21	1:C:238:MSE:SE	2.60	0.51
1:D:127:ALA:O	1:D:154:ARG:NH2	2.42	0.51
1:B:204:ALA:CB	4:B:345:HOH:O	2.57	0.51
1:A:211:GLU:C	1:A:213:GLN:H	2.13	0.51
1:B:198:VAL:HG21	1:B:238:MSE:SE	2.61	0.51
1:D:55:ARG:HD3	1:D:81:LEU:HD11	1.93	0.51
1:B:36:ILE:HD11	1:B:72:GLN:HB2	1.93	0.51
1:C:165:VAL:HG23	1:C:189:LEU:HD11	1.93	0.51
1:A:62:ASN:HB3	1:A:85:HIS:CD2	2.45	0.50
1:C:235:LEU:HD23	1:C:235:LEU:C	2.31	0.50
1:A:23:LYS:HE3	1:C:19:ASP:OD1	2.11	0.50
1:D:98:SER:O	1:D:99:ALA:CB	2.59	0.50
1:A:183:GLU:OE2	1:A:201:GLN:NE2	2.41	0.50
1:A:210:GLN:O	1:A:212:GLY:N	2.41	0.50
1:B:132:ILE:HG12	1:B:157:THR:HB	1.93	0.50
1:C:2:ARG:NH1	1:C:126:ASP:OD2	2.44	0.50
1:D:145:ARG:O	1:D:149:GLN:HG3	2.12	0.50

Continued on next page...

Continued from previous page...

Atom-1	Atom-2	Interatomic distance (Å)	Clash overlap (Å)
1:A:106:ILE:HD12	1:A:106:ILE:N	2.26	0.49
1:A:173:TRP:HA	1:A:176:ILE:HD12	1.94	0.49
1:A:237:VAL:HG21	1:A:260:ALA:CB	2.42	0.49
1:A:23:LYS:CE	1:C:19:ASP:OD1	2.60	0.49
1:D:198:VAL:HG21	1:D:238:MSE:SE	2.63	0.49
1:C:62:ASN:HB3	1:C:85:HIS:HD2	1.78	0.49
1:B:227:THR:HG22	4:B:317:HOH:O	2.11	0.49
1:C:82:PRO:HD3	1:C:115:PHE:CZ	2.48	0.48
1:B:34:GLN:NE2	4:B:348:HOH:O	2.45	0.48
1:C:87:ASN:O	1:C:88:GLN:HG2	2.13	0.48
1:B:11:VAL:HG13	1:B:34:GLN:HG2	1.96	0.48
1:D:110:ALA:HB3	4:D:327:HOH:O	2.12	0.48
1:A:108:THR:HG23	1:C:15:TRP:CZ3	2.49	0.48
1:A:235:LEU:C	1:A:235:LEU:HD23	2.34	0.48
1:B:6:THR:OG1	1:B:135:GLN:HG2	2.13	0.48
1:C:173:TRP:CZ2	1:C:191:PRO:HG3	2.48	0.48
1:D:86:PHE:CE2	1:D:115:PHE:HA	2.49	0.47
1:C:43:GLN:HE21	1:C:134:LEU:HD21	1.79	0.47
1:D:73:ILE:HG21	1:D:80:LEU:HB2	1.96	0.47
1:A:13:GLU:HG2	1:A:34:GLN:HG2	1.96	0.47
1:A:65:ASN:O	1:A:69:ILE:HG13	2.15	0.47
1:D:278:ARG:H	1:D:278:ARG:HG3	1.27	0.47
1:A:87:ASN:O	1:A:88:GLN:CG	2.62	0.47
1:C:117:LEU:HD21	1:C:146:ALA:HB1	1.97	0.47
1:D:124:MSE:CE	1:D:156:MSE:HE1	2.44	0.47
1:D:225:LEU:HD22	1:D:268:ARG:CG	2.42	0.47
1:A:20:ILE:HG13	1:A:97:ASN:OD1	2.13	0.47
1:C:210:GLN:O	1:C:211:GLU:C	2.53	0.47
1:D:165:VAL:HG23	1:D:189:LEU:HD11	1.95	0.47
1:D:283:LEU:C	1:D:283:LEU:HD23	2.35	0.47
1:A:87:ASN:C	1:A:88:GLN:CG	2.81	0.47
1:B:283:LEU:HD23	1:B:283:LEU:C	2.36	0.47
1:C:102:ASP:OD1	1:C:103:ASN:N	2.47	0.47
1:D:225:LEU:HD21	1:D:268:ARG:NE	2.24	0.47
1:A:8:ASN:H	1:A:8:ASN:ND2	2.07	0.46
1:D:100:ASP:OD1	1:D:101:GLY:N	2.48	0.46
1:A:135:GLN:HE21	1:A:139:PHE:HD2	1.63	0.46
1:C:12:ASP:O	1:C:34:GLN:HA	2.15	0.46
1:C:88:GLN:CG	4:C:354:HOH:O	2.63	0.46
1:A:211:GLU:HA	1:A:211:GLU:OE1	2.16	0.46
1:A:97:ASN:CB	1:A:100:ASP:HB2	2.46	0.46

Continued on next page...

Continued from previous page...

Atom-1	Atom-2	Interatomic distance (Å)	Clash overlap (Å)
1:A:100:ASP:HB2	4:A:322:HOH:O	2.15	0.46
1:D:124:MSE:CE	1:D:133:LEU:HD13	2.46	0.46
1:A:198:VAL:HG21	1:A:238:MSE:SE	2.65	0.46
1:B:13:GLU:HG2	1:B:34:GLN:HG3	1.98	0.46
1:B:27:ILE:C	1:B:27:ILE:HD12	2.36	0.46
1:A:17:ILE:HD11	1:A:95:ILE:CG2	2.45	0.46
1:D:91:ASP:HA	1:D:108:THR:HG23	1.98	0.46
1:B:11:VAL:O	1:B:91:ASP:HB2	2.16	0.46
1:A:145:ARG:HB2	1:A:172:LEU:HD21	1.98	0.45
1:B:160:PHE:HB2	1:B:176:ILE:HD12	1.98	0.45
1:A:116:SER:OG	1:A:119:GLU:HG2	2.16	0.45
1:B:116:SER:OG	1:B:119:GLU:HG3	2.16	0.45
1:B:19:ASP:CB	1:B:97:ASN:ND2	2.78	0.45
1:B:62:ASN:CB	1:B:85:HIS:HD2	2.27	0.45
1:C:39:LYS:HB3	1:C:136:GLN:HG2	1.98	0.45
1:A:8:ASN:HD22	1:A:8:ASN:N	1.99	0.45
1:D:68:TRP:O	1:D:72:GLN:HG2	2.16	0.45
1:D:82:PRO:HG3	1:D:123:HIS:NE2	2.31	0.45
1:D:91:ASP:HA	1:D:108:THR:CG2	2.47	0.45
1:D:71:GLN:OE1	1:D:74:LYS:HE2	2.17	0.45
1:A:117:LEU:H	1:A:143:LYS:HZ2	1.64	0.44
1:B:31:LYS:CE	1:B:34:GLN:HE21	2.30	0.44
1:B:50:CYS:SG	1:B:280:LEU:HG	2.57	0.44
1:C:173:TRP:N	1:C:174:PRO:HD2	2.33	0.44
1:D:87:ASN:ND2	4:D:364:HOH:O	2.50	0.44
1:D:136:GLN:HA	1:D:161:ASN:O	2.16	0.44
1:A:152:ARG:NH1	1:A:175:LEU:HA	2.31	0.44
1:B:165:VAL:CG2	1:B:188:LEU:HD23	2.34	0.44
1:B:92:THR:OG1	1:B:105:ILE:HG23	2.18	0.44
1:A:135:GLN:NE2	1:A:147:LEU:HD12	2.30	0.44
1:B:120:MSE:HE1	1:B:139:PHE:CE2	2.53	0.44
1:D:163:SER:HA	1:D:164:PRO:C	2.38	0.44
1:A:2:ARG:HG2	1:A:53:GLU:HB3	2.00	0.44
1:D:12:ASP:O	1:D:34:GLN:HA	2.18	0.44
1:B:211:GLU:OE1	1:B:211:GLU:O	2.36	0.43
1:C:88:GLN:HG3	4:C:354:HOH:O	2.16	0.43
1:C:141:LEU:HD11	1:C:172:LEU:CD1	2.47	0.43
1:D:150:TYR:O	1:D:152:ARG:O	2.36	0.43
1:A:17:ILE:HD11	1:A:95:ILE:HG23	2.00	0.43
1:A:43:GLN:HE22	1:A:161:ASN:HD22	1.65	0.43
1:B:27:ILE:CD1	1:D:106:ILE:HG23	2.48	0.43

Continued on next page...

Continued from previous page...

Atom-1	Atom-2	Interatomic distance (Å)	Clash overlap (Å)
1:C:20:ILE:O	1:C:20:ILE:HG13	2.18	0.43
1:B:88:GLN:HG2	1:D:31:LYS:HB2	1.99	0.43
1:B:235:LEU:C	1:B:235:LEU:HD23	2.39	0.43
1:D:117:LEU:HD21	1:D:146:ALA:HB1	2.01	0.42
1:A:163:SER:HA	1:A:164:PRO:C	2.39	0.42
1:B:227:THR:CG2	4:B:395:HOH:O	2.66	0.42
1:D:235:LEU:C	1:D:235:LEU:HD23	2.39	0.42
1:C:204:ALA:C	4:C:341:HOH:O	2.56	0.42
1:B:19:ASP:HA	1:B:97:ASN:OD1	2.19	0.42
1:C:39:LYS:NZ	4:C:388:HOH:O	2.52	0.42
1:C:163:SER:HA	1:C:164:PRO:C	2.39	0.42
1:C:259:ARG:HB3	1:C:283:LEU:HD11	2.00	0.42
1:A:61:GLY:CA	1:A:89:HIS:HD2	2.32	0.42
1:A:20:ILE:HD11	1:A:104:ALA:HB2	2.01	0.42
1:A:267:ARG:HD2	1:A:273:ALA:O	2.19	0.42
1:B:43:GLN:HE22	1:B:161:ASN:HD22	1.67	0.42
1:B:108:THR:HG23	1:D:15:TRP:CZ3	2.54	0.42
1:B:237:VAL:HG21	1:B:260:ALA:CB	2.50	0.42
1:D:109:THR:HG23	1:D:113:ASP:OD2	2.20	0.41
1:D:141:LEU:CG	1:D:145:ARG:HH12	2.33	0.41
1:B:12:ASP:OD1	1:B:92:THR:CG2	2.65	0.41
1:B:87:ASN:HB3	1:B:88:GLN:H	1.19	0.41
1:A:97:ASN:HB2	1:A:100:ASP:HB3	2.02	0.41
1:D:231:GLY:HA2	2:D:900:ATP:H5'2	2.02	0.41
1:A:201:GLN:O	1:A:204:ALA:HB3	2.20	0.41
1:B:281:ALA:O	1:B:285:THR:HG22	2.20	0.41
1:C:-1:LEU:HD12	1:C:2:ARG:H	1.83	0.41
1:A:141:LEU:HD22	1:A:168:ASP:CB	2.45	0.41
1:B:61:GLY:CA	1:B:89:HIS:HD1	2.33	0.41
1:C:210:GLN:O	1:C:213:GLN:N	2.51	0.41
1:D:88:GLN:NE2	1:D:110:ALA:HB1	2.35	0.41
1:A:268:ARG:O	1:A:273:ALA:HB2	2.21	0.41
1:B:152:ARG:HD2	1:B:152:ARG:HA	1.96	0.41
1:C:205:GLY:N	4:C:341:HOH:O	2.54	0.41
1:C:116:SER:O	1:C:120:MSE:HG3	2.21	0.41
1:A:66:GLY:HA2	1:A:89:HIS:CE1	2.56	0.40
1:A:213:GLN:N	1:A:213:GLN:HE21	2.19	0.40
1:A:259:ARG:HD2	1:A:283:LEU:HB2	2.04	0.40
1:B:239:LEU:HG	1:B:243:LEU:HD22	2.02	0.40
1:C:3:VAL:HG11	1:C:47:LEU:HD13	2.03	0.40
1:D:215:GLN:OE1	1:D:251:ALA:HB2	2.20	0.40

Continued on next page...

Continued from previous page...

Atom-1	Atom-2	Interatomic distance (Å)	Clash overlap (Å)
1:B:19:ASP:CA	1:B:97:ASN:ND2	2.81	0.40
1:C:54:THR:O	1:C:78:LEU:HD12	2.21	0.40
1:B:205:GLY:N	4:B:345:HOH:O	2.55	0.40

There are no symmetry-related clashes.

5.3 Torsion angles [i](#)

5.3.1 Protein backbone [i](#)

In the following table, the Percentiles column shows the percent Ramachandran outliers of the chain as a percentile score with respect to all X-ray entries followed by that with respect to entries of similar resolution.

The Analysed column shows the number of residues for which the backbone conformation was analysed, and the total number of residues.

Mol	Chain	Analysed	Favoured	Allowed	Outliers	Percentiles
1	A	284/299 (95%)	267 (94%)	12 (4%)	5 (2%)	8 2
1	B	279/299 (93%)	268 (96%)	9 (3%)	2 (1%)	22 11
1	C	283/299 (95%)	272 (96%)	9 (3%)	2 (1%)	22 11
1	D	284/299 (95%)	268 (94%)	10 (4%)	6 (2%)	7 1
All	All	1130/1196 (94%)	1075 (95%)	40 (4%)	15 (1%)	12 3

All (15) Ramachandran outliers are listed below:

Mol	Chain	Res	Type
1	A	88	GLN
1	B	87	ASN
1	B	89	HIS
1	D	98	SER
1	D	99	ALA
1	D	224	ALA
1	A	89	HIS
1	A	210	GLN
1	A	101	GLY
1	D	23	LYS
1	D	223	GLU
1	A	98	SER

Continued on next page...

Continued from previous page...

Mol	Chain	Res	Type
1	C	101	GLY
1	C	211	GLU
1	D	100	ASP

5.3.2 Protein sidechains [i](#)

In the following table, the Percentiles column shows the percent sidechain outliers of the chain as a percentile score with respect to all X-ray entries followed by that with respect to entries of similar resolution.

The Analysed column shows the number of residues for which the sidechain conformation was analysed, and the total number of residues.

Mol	Chain	Analysed	Rotameric	Outliers	Percentiles	
1	A	224/228 (98%)	210 (94%)	14 (6%)	18	7
1	B	222/228 (97%)	216 (97%)	6 (3%)	44	34
1	C	223/228 (98%)	219 (98%)	4 (2%)	59	52
1	D	224/228 (98%)	216 (96%)	8 (4%)	35	23
All	All	893/912 (98%)	861 (96%)	32 (4%)	35	23

All (32) residues with a non-rotameric sidechain are listed below:

Mol	Chain	Res	Type
1	A	-1	LEU
1	A	8	ASN
1	A	32	VAL
1	A	35	ASP
1	A	71	GLN
1	A	87	ASN
1	A	89	HIS
1	A	100	ASP
1	A	138	ASN
1	A	189	LEU
1	A	210	GLN
1	A	211	GLU
1	A	223	GLU
1	A	285	THR
1	B	34	GLN
1	B	152	ARG
1	B	211	GLU
1	B	243	LEU

Continued on next page...

Continued from previous page...

Mol	Chain	Res	Type
1	B	280	LEU
1	B	283	LEU
1	C	-1	LEU
1	C	74	LYS
1	C	115	PHE
1	C	243	LEU
1	D	87	ASN
1	D	98	SER
1	D	100	ASP
1	D	115	PHE
1	D	183	GLU
1	D	223	GLU
1	D	225	LEU
1	D	278	ARG

Sometimes sidechains can be flipped to improve hydrogen bonding and reduce clashes. All (32) such sidechains are listed below:

Mol	Chain	Res	Type
1	A	8	ASN
1	A	28	HIS
1	A	34	GLN
1	A	89	HIS
1	A	123	HIS
1	A	135	GLN
1	A	161	ASN
1	A	201	GLN
1	A	213	GLN
1	A	256	HIS
1	B	34	GLN
1	B	85	HIS
1	B	97	ASN
1	B	123	HIS
1	B	135	GLN
1	B	161	ASN
1	B	215	GLN
1	B	256	HIS
1	C	28	HIS
1	C	43	GLN
1	C	85	HIS
1	C	97	ASN
1	C	135	GLN
1	C	161	ASN

Continued on next page...

Continued from previous page...

Mol	Chain	Res	Type
1	D	43	GLN
1	D	62	ASN
1	D	85	HIS
1	D	87	ASN
1	D	88	GLN
1	D	97	ASN
1	D	135	GLN
1	D	161	ASN

5.3.3 RNA [i](#)

There are no RNA molecules in this entry.

5.4 Non-standard residues in protein, DNA, RNA chains [i](#)

There are no non-standard protein/DNA/RNA residues in this entry.

5.5 Carbohydrates [i](#)

There are no monosaccharides in this entry.

5.6 Ligand geometry [i](#)

6 ligands are modelled in this entry.

In the following table, the Counts columns list the number of bonds (or angles) for which Mogul statistics could be retrieved, the number of bonds (or angles) that are observed in the model and the number of bonds (or angles) that are defined in the Chemical Component Dictionary. The Link column lists molecule types, if any, to which the group is linked. The Z score for a bond length (or angle) is the number of standard deviations the observed value is removed from the expected value. A bond length (or angle) with $|Z| > 2$ is considered an outlier worth inspection. RMSZ is the root-mean-square of all Z scores of the bond lengths (or angles).

Mol	Type	Chain	Res	Link	Bond lengths			Bond angles		
					Counts	RMSZ	# Z > 2	Counts	RMSZ	# Z > 2
2	ATP	B	900	-	26,33,33	2.10	7 (26%)	31,52,52	2.27	9 (29%)
3	GOL	C	501	-	5,5,5	0.33	0	5,5,5	0.34	0
2	ATP	A	900	-	26,33,33	2.16	7 (26%)	31,52,52	2.22	10 (32%)
3	GOL	D	501	-	5,5,5	0.34	0	5,5,5	0.25	0
2	ATP	C	900	-	26,33,33	2.05	7 (26%)	31,52,52	2.35	8 (25%)

Mol	Type	Chain	Res	Link	Bond lengths			Bond angles		
					Counts	RMSZ	# Z > 2	Counts	RMSZ	# Z > 2
2	ATP	D	900	-	26,33,33	2.07	8 (30%)	31,52,52	2.27	8 (25%)

In the following table, the Chirals column lists the number of chiral outliers, the number of chiral centers analysed, the number of these observed in the model and the number defined in the Chemical Component Dictionary. Similar counts are reported in the Torsion and Rings columns. '-' means no outliers of that kind were identified.

Mol	Type	Chain	Res	Link	Chirals	Torsions	Rings
2	ATP	B	900	-	-	5/18/38/38	0/3/3/3
3	GOL	C	501	-	-	0/4/4/4	-
2	ATP	A	900	-	-	7/18/38/38	0/3/3/3
3	GOL	D	501	-	-	0/4/4/4	-
2	ATP	C	900	-	-	8/18/38/38	0/3/3/3
2	ATP	D	900	-	-	7/18/38/38	0/3/3/3

All (29) bond length outliers are listed below:

Mol	Chain	Res	Type	Atoms	Z	Observed(Å)	Ideal(Å)
2	A	900	ATP	PA-O5'	5.93	1.83	1.59
2	B	900	ATP	PA-O5'	5.57	1.81	1.59
2	D	900	ATP	PA-O5'	5.55	1.81	1.59
2	C	900	ATP	PA-O5'	5.54	1.81	1.59
2	A	900	ATP	C4-N3	4.40	1.41	1.35
2	B	900	ATP	C4-N3	4.25	1.41	1.35
2	D	900	ATP	C4-N3	4.24	1.41	1.35
2	A	900	ATP	C2-N3	4.17	1.38	1.32
2	B	900	ATP	C2-N3	3.99	1.38	1.32
2	D	900	ATP	C2-N3	3.85	1.38	1.32
2	C	900	ATP	C2-N3	3.78	1.38	1.32
2	A	900	ATP	C5-C4	3.72	1.50	1.40
2	C	900	ATP	C4-N3	3.55	1.40	1.35
2	B	900	ATP	C5-C4	3.49	1.50	1.40
2	D	900	ATP	C5-C4	3.41	1.49	1.40
2	C	900	ATP	C2'-C1'	-3.29	1.48	1.53
2	C	900	ATP	C5-C4	3.28	1.49	1.40
2	B	900	ATP	C2'-C1'	-3.24	1.48	1.53
2	C	900	ATP	C2-N1	2.92	1.39	1.33
2	D	900	ATP	C2'-C1'	-2.88	1.49	1.53
2	A	900	ATP	C2'-C1'	-2.82	1.49	1.53
2	A	900	ATP	C2-N1	2.81	1.39	1.33
2	B	900	ATP	C2-N1	2.71	1.39	1.33

Continued on next page...

Continued from previous page...

Mol	Chain	Res	Type	Atoms	Z	Observed(Å)	Ideal(Å)
2	D	900	ATP	C2-N1	2.63	1.38	1.33
2	C	900	ATP	O5'-C5'	-2.23	1.36	1.44
2	A	900	ATP	C6-C5	2.19	1.51	1.43
2	D	900	ATP	O5'-C5'	-2.12	1.36	1.44
2	D	900	ATP	C6-C5	2.04	1.50	1.43
2	B	900	ATP	O5'-C5'	-2.02	1.37	1.44

All (35) bond angle outliers are listed below:

Mol	Chain	Res	Type	Atoms	Z	Observed(°)	Ideal(°)
2	C	900	ATP	PA-O5'-C5'	6.76	161.30	121.68
2	D	900	ATP	PA-O5'-C5'	6.67	160.80	121.68
2	B	900	ATP	PA-O5'-C5'	6.50	159.77	121.68
2	A	900	ATP	PA-O5'-C5'	6.47	159.59	121.68
2	C	900	ATP	N3-C2-N1	-5.54	120.02	128.68
2	D	900	ATP	N3-C2-N1	-5.41	120.22	128.68
2	B	900	ATP	N3-C2-N1	-5.32	120.36	128.68
2	A	900	ATP	N3-C2-N1	-5.20	120.55	128.68
2	C	900	ATP	O4'-C4'-C5'	-5.06	92.72	109.37
2	B	900	ATP	O4'-C4'-C5'	-4.81	93.54	109.37
2	D	900	ATP	O4'-C4'-C5'	-4.61	94.20	109.37
2	A	900	ATP	O4'-C4'-C5'	-4.46	94.70	109.37
2	C	900	ATP	O5'-PA-O1A	3.32	122.03	109.07
2	B	900	ATP	O5'-PA-O1A	3.10	121.16	109.07
2	A	900	ATP	C1'-N9-C4	-3.02	121.33	126.64
2	C	900	ATP	C1'-N9-C4	-3.01	121.35	126.64
2	C	900	ATP	C2-N1-C6	2.94	123.78	118.75
2	D	900	ATP	C2-N1-C6	2.94	123.78	118.75
2	B	900	ATP	C1'-N9-C4	-2.92	121.50	126.64
2	D	900	ATP	C1'-N9-C4	-2.91	121.52	126.64
2	C	900	ATP	O4'-C4'-C3'	-2.88	99.42	105.11
2	B	900	ATP	C2-N1-C6	2.83	123.59	118.75
2	D	900	ATP	O5'-PA-O1A	2.80	120.02	109.07
2	A	900	ATP	O5'-PA-O1A	2.76	119.87	109.07
2	D	900	ATP	O4'-C4'-C3'	-2.76	99.65	105.11
2	A	900	ATP	C2-N1-C6	2.76	123.47	118.75
2	B	900	ATP	O4'-C4'-C3'	-2.63	99.91	105.11
2	A	900	ATP	O4'-C4'-C3'	-2.58	100.01	105.11
2	A	900	ATP	C3'-C2'-C1'	2.18	104.26	100.98
2	D	900	ATP	C5'-C4'-C3'	2.09	123.02	115.18
2	B	900	ATP	C3'-C2'-C1'	2.08	104.11	100.98
2	A	900	ATP	C5'-C4'-C3'	2.07	122.95	115.18

Continued on next page...

Continued from previous page...

Mol	Chain	Res	Type	Atoms	Z	Observed(°)	Ideal(°)
2	C	900	ATP	C5'-C4'-C3'	2.04	122.83	115.18
2	A	900	ATP	C4-C5-N7	-2.03	107.28	109.40
2	B	900	ATP	C5'-C4'-C3'	2.03	122.78	115.18

There are no chirality outliers.

All (27) torsion outliers are listed below:

Mol	Chain	Res	Type	Atoms
2	A	900	ATP	C5'-O5'-PA-O2A
2	A	900	ATP	C5'-O5'-PA-O3A
2	B	900	ATP	C5'-O5'-PA-O2A
2	B	900	ATP	C5'-O5'-PA-O3A
2	C	900	ATP	C5'-O5'-PA-O2A
2	C	900	ATP	C5'-O5'-PA-O3A
2	D	900	ATP	C5'-O5'-PA-O2A
2	D	900	ATP	C5'-O5'-PA-O3A
2	A	900	ATP	C3'-C4'-C5'-O5'
2	B	900	ATP	C3'-C4'-C5'-O5'
2	C	900	ATP	C3'-C4'-C5'-O5'
2	D	900	ATP	C3'-C4'-C5'-O5'
2	A	900	ATP	O4'-C4'-C5'-O5'
2	B	900	ATP	O4'-C4'-C5'-O5'
2	D	900	ATP	O4'-C4'-C5'-O5'
2	C	900	ATP	O4'-C4'-C5'-O5'
2	A	900	ATP	C5'-O5'-PA-O1A
2	B	900	ATP	C5'-O5'-PA-O1A
2	C	900	ATP	C5'-O5'-PA-O1A
2	D	900	ATP	C5'-O5'-PA-O1A
2	D	900	ATP	PG-O3B-PB-O2B
2	C	900	ATP	PB-O3B-PG-O1G
2	A	900	ATP	PB-O3B-PG-O2G
2	C	900	ATP	PB-O3B-PG-O3G
2	A	900	ATP	PA-O3A-PB-O1B
2	C	900	ATP	PG-O3B-PB-O1B
2	D	900	ATP	PG-O3B-PB-O1B

There are no ring outliers.

1 monomer is involved in 1 short contact:

Mol	Chain	Res	Type	Clashes	Symm-Clashes
2	D	900	ATP	1	0

The following is a two-dimensional graphical depiction of Mogul quality analysis of bond lengths, bond angles, torsion angles, and ring geometry for all instances of the Ligand of Interest. In addition, ligands with molecular weight > 250 and outliers as shown on the validation Tables will also be included. For torsion angles, if less than 5% of the Mogul distribution of torsion angles is within 10 degrees of the torsion angle in question, then that torsion angle is considered an outlier. Any bond that is central to one or more torsion angles identified as an outlier by Mogul will be highlighted in the graph. For rings, the root-mean-square deviation (RMSD) between the ring in question and similar rings identified by Mogul is calculated over all ring torsion angles. If the average RMSD is greater than 60 degrees and the minimal RMSD between the ring in question and any Mogul-identified rings is also greater than 60 degrees, then that ring is considered an outlier. The outliers are highlighted in purple. The color gray indicates Mogul did not find sufficient equivalents in the CSD to analyse the geometry.

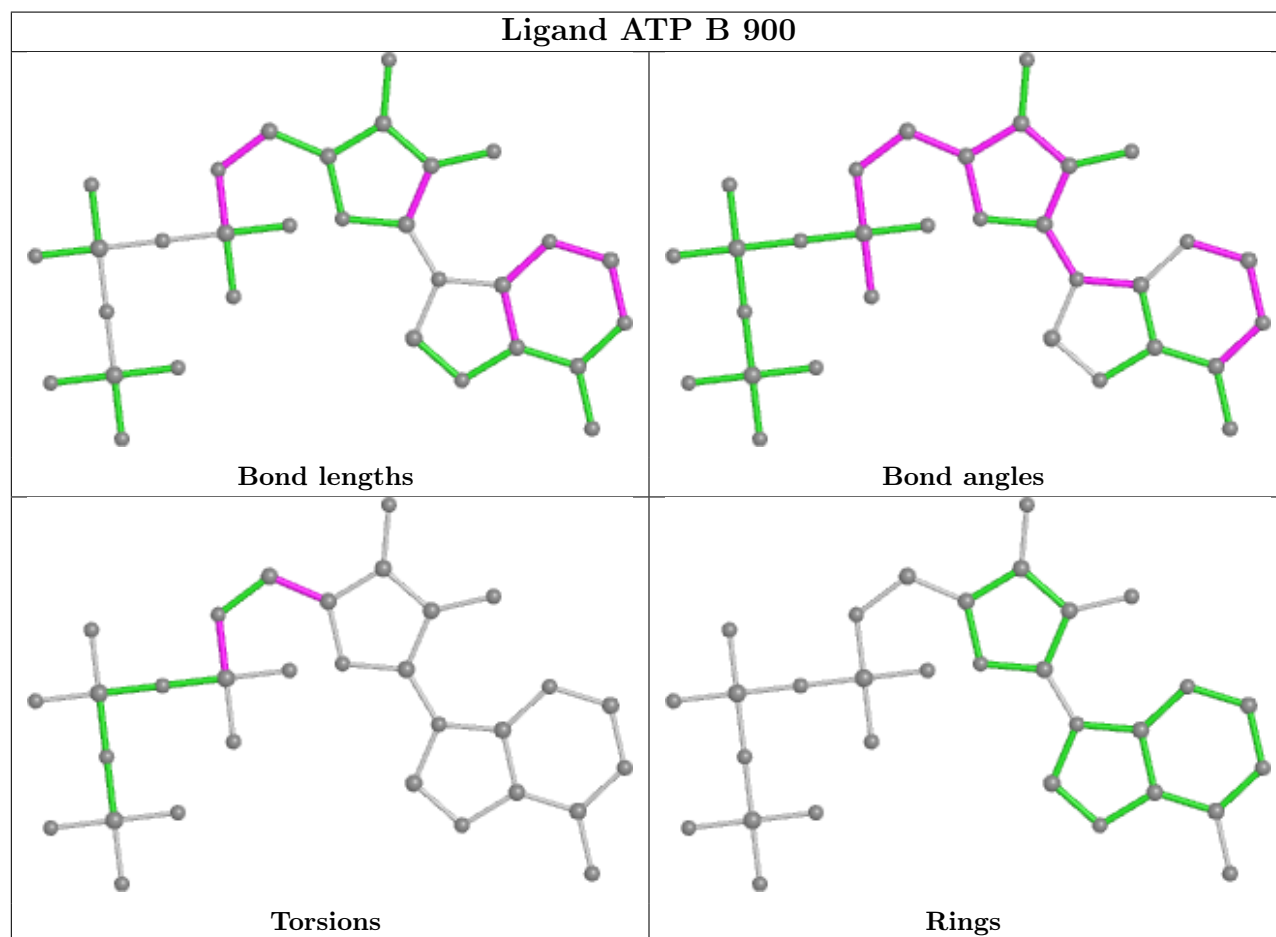

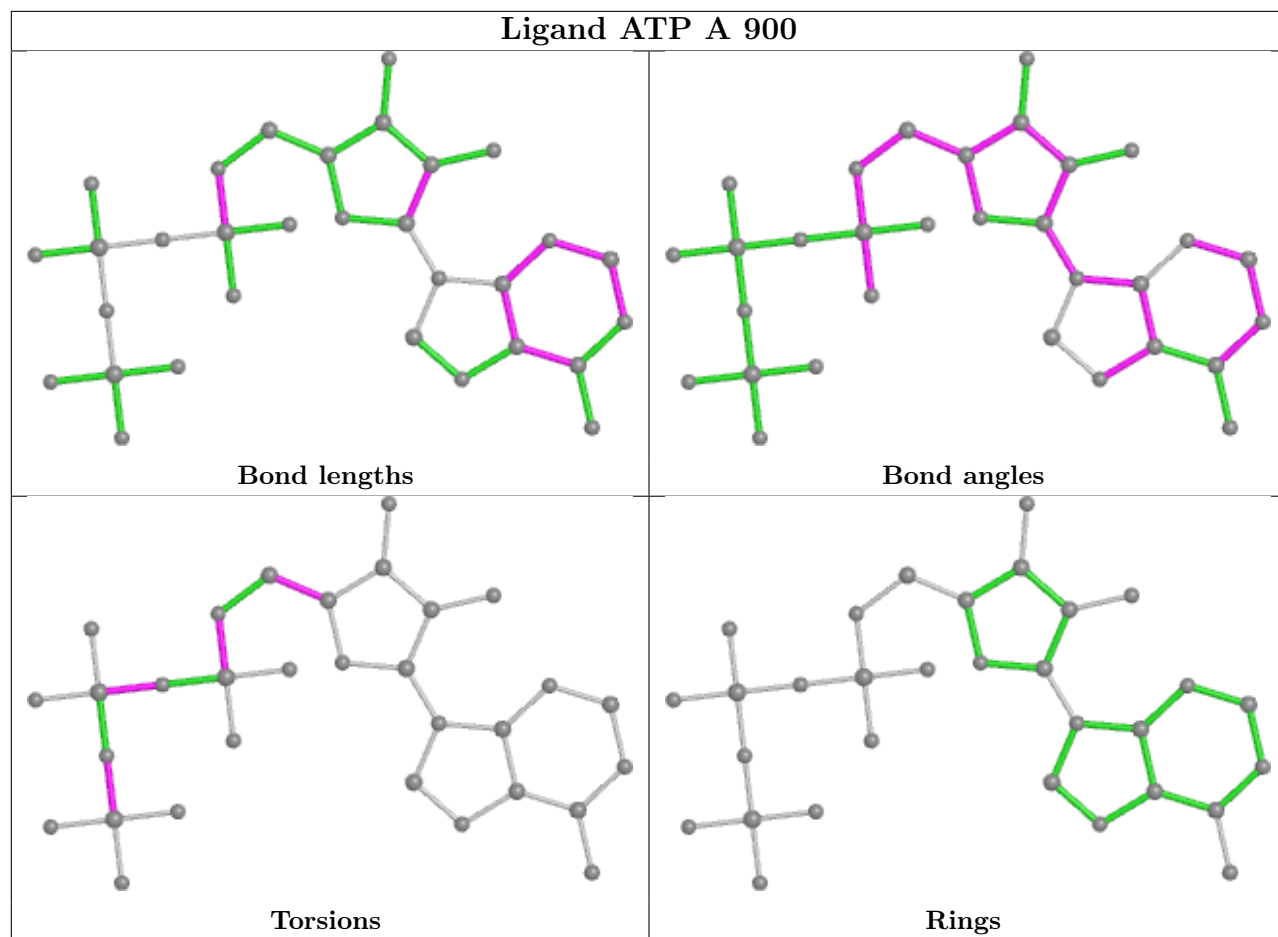

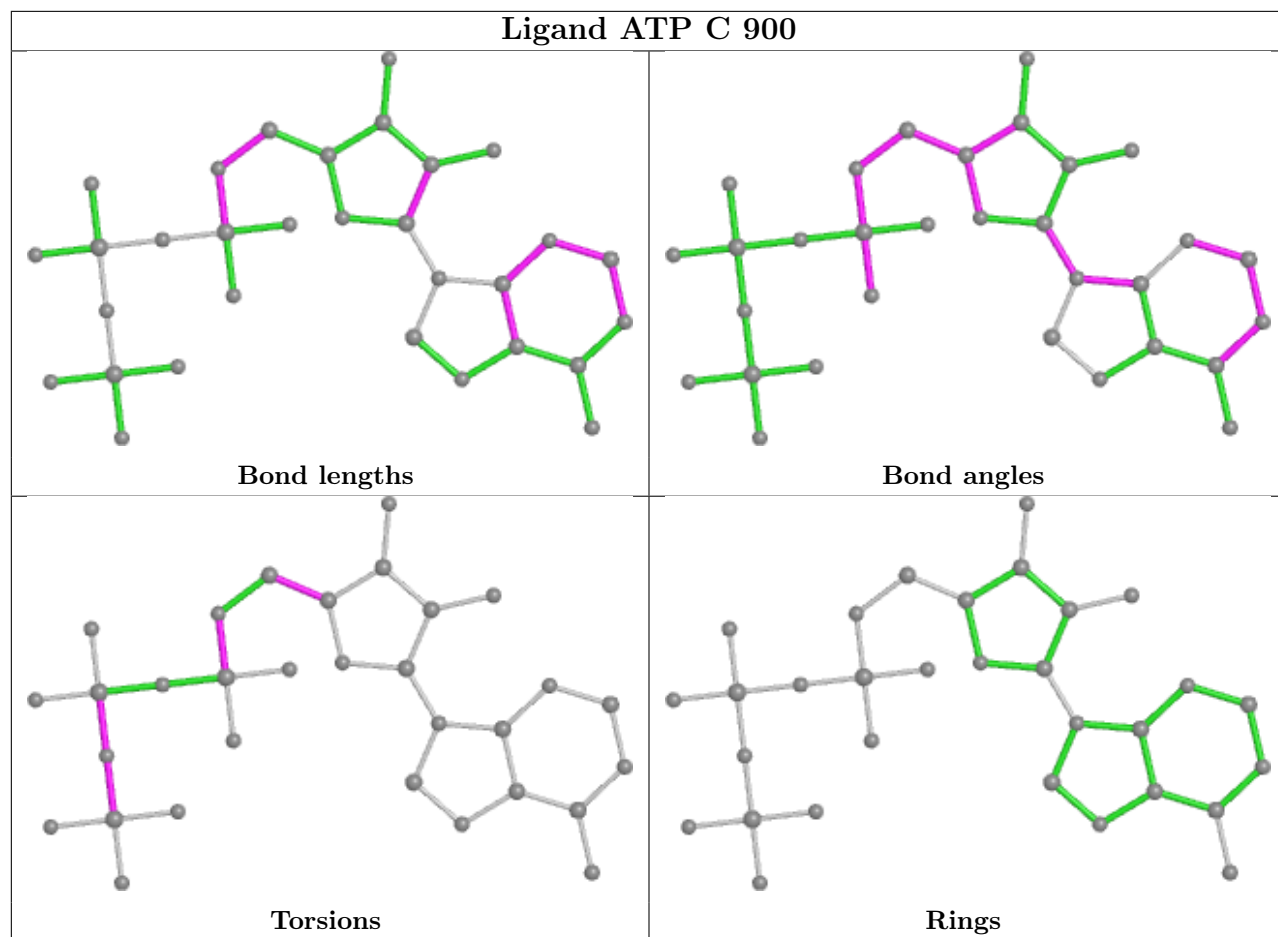

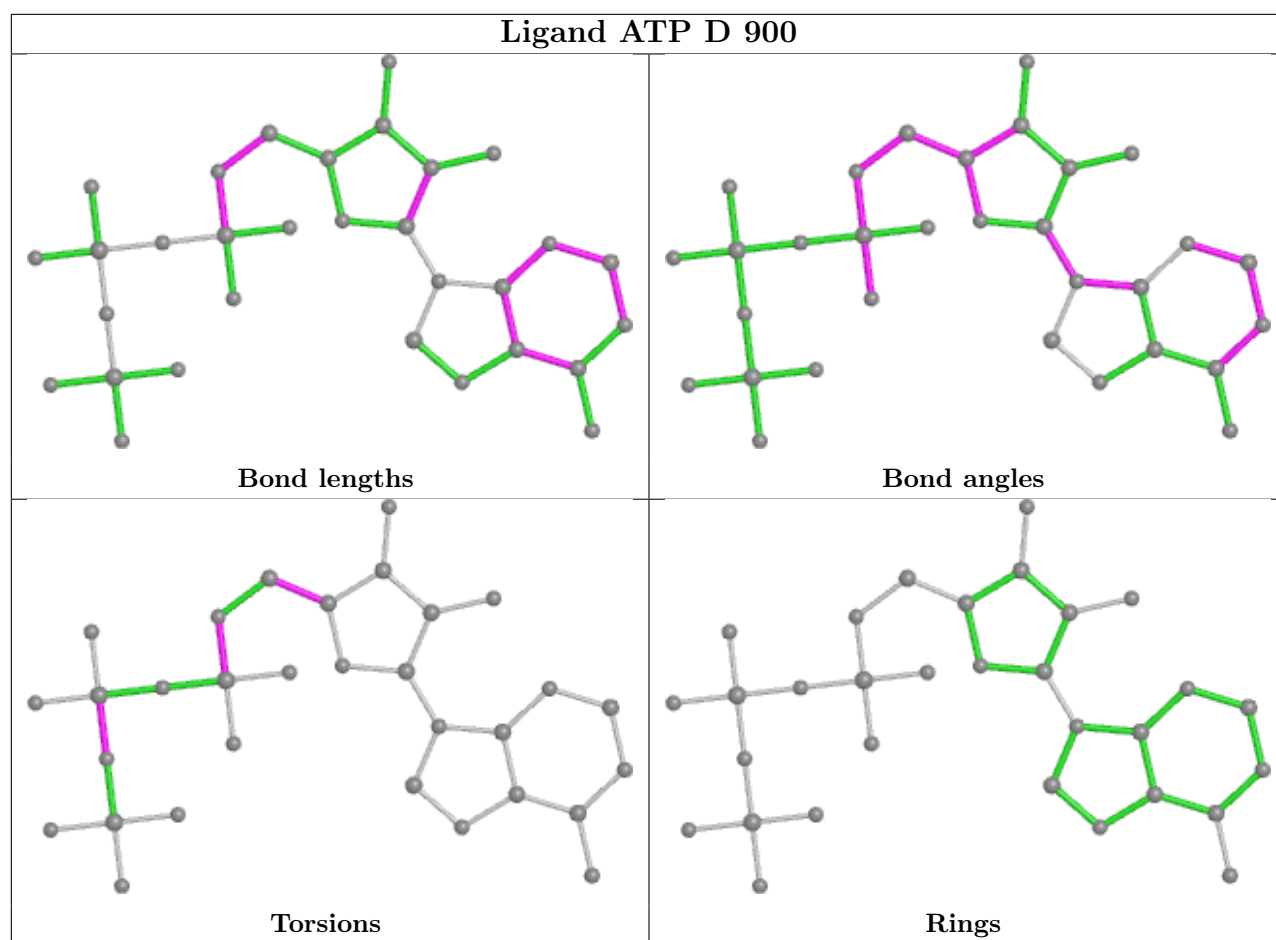

5.7 Other polymers [i](#)

There are no such residues in this entry.

5.8 Polymer linkage issues [i](#)

There are no chain breaks in this entry.

6 Fit of model and data

6.1 Protein, DNA and RNA chains

In the following table, the column labelled ‘#RSRZ > 2’ contains the number (and percentage) of RSRZ outliers, followed by percent RSRZ outliers for the chain as percentile scores relative to all X-ray entries and entries of similar resolution. The OWAB column contains the minimum, median, 95th percentile and maximum values of the occupancy-weighted average B-factor per residue. The column labelled ‘Q < 0.9’ lists the number of (and percentage) of residues with an average occupancy less than 0.9.

Mol	Chain	Analysed	<RSRZ>	#RSRZ>2	OWAB(Å ²)	Q<0.9
1	A	281/299 (93%)	0.26	17 (6%) 21 23	18, 32, 49, 64	0
1	B	278/299 (92%)	0.10	15 (5%) 25 27	17, 28, 51, 61	0
1	C	280/299 (93%)	0.01	8 (2%) 51 53	18, 27, 45, 56	0
1	D	281/299 (93%)	0.36	21 (7%) 14 15	19, 34, 55, 71	0
All	All	1120/1196 (93%)	0.18	61 (5%) 25 27	17, 30, 51, 71	0

All (61) RSRZ outliers are listed below:

Mol	Chain	Res	Type	RSRZ
1	A	99	ALA	6.8
1	A	210	GLN	5.8
1	D	100	ASP	5.8
1	A	84	GLY	5.6
1	B	99	ALA	4.8
1	D	87	ASN	4.5
1	B	98	SER	4.3
1	C	102	ASP	3.8
1	D	98	SER	3.7
1	D	23	LYS	3.7
1	A	89	HIS	3.6
1	B	89	HIS	3.6
1	D	223	GLU	3.6
1	C	101	GLY	3.5
1	C	211	GLU	3.5
1	C	212	GLY	3.5
1	D	25	ALA	3.5
1	D	212	GLY	3.5
1	A	88	GLN	3.4
1	A	100	ASP	3.4
1	C	20	ILE	3.3

Continued on next page...

Continued from previous page...

Mol	Chain	Res	Type	RSRZ
1	C	100	ASP	3.3
1	A	192	TYR	3.3
1	B	97	ASN	3.2
1	B	212	GLY	3.2
1	A	98	SER	3.1
1	D	118	ASP	3.1
1	A	211	GLU	3.1
1	A	171	HIS	3.0
1	A	86	PHE	2.9
1	A	101	GLY	2.8
1	B	188	LEU	2.7
1	B	20	ILE	2.7
1	D	285	THR	2.5
1	D	192	TYR	2.5
1	D	114	THR	2.4
1	B	211	GLU	2.4
1	B	62	ASN	2.4
1	D	211	GLU	2.4
1	B	87	ASN	2.4
1	A	102	ASP	2.4
1	D	268	ARG	2.4
1	B	84	GLY	2.3
1	A	195	LYS	2.3
1	C	23	LYS	2.3
1	A	83	ASP	2.3
1	B	96	LEU	2.3
1	D	115	PHE	2.3
1	B	102	ASP	2.3
1	D	222	ALA	2.2
1	D	225	LEU	2.2
1	D	83	ASP	2.2
1	A	223	GLU	2.1
1	A	36	ILE	2.1
1	D	102	ASP	2.0
1	B	86	PHE	2.0
1	D	153	SER	2.0
1	D	195	LYS	2.0
1	B	192	TYR	2.0
1	C	25	ALA	2.0
1	D	134	LEU	2.0

6.2 Non-standard residues in protein, DNA, RNA chains [i](#)

There are no non-standard protein/DNA/RNA residues in this entry.

6.3 Carbohydrates [i](#)

There are no monosaccharides in this entry.

6.4 Ligands [i](#)

In the following table, the Atoms column lists the number of modelled atoms in the group and the number defined in the chemical component dictionary. The B-factors column lists the minimum, median, 95th percentile and maximum values of B factors of atoms in the group. The column labelled 'Q< 0.9' lists the number of atoms with occupancy less than 0.9.

Mol	Type	Chain	Res	Atoms	RSCC	RSR	B-factors(\AA^2)	Q<0.9
3	GOL	C	501	6/6	0.88	0.19	30,33,39,44	0
2	ATP	A	900	31/31	0.89	0.13	34,39,61,62	0
3	GOL	D	501	6/6	0.92	0.13	32,33,38,43	0
2	ATP	D	900	31/31	0.93	0.12	33,36,52,53	0
2	ATP	B	900	31/31	0.94	0.11	24,30,50,52	0
2	ATP	C	900	31/31	0.97	0.10	20,24,44,47	0

The following is a graphical depiction of the model fit to experimental electron density of all instances of the Ligand of Interest. In addition, ligands with molecular weight > 250 and outliers as shown on the geometry validation Tables will also be included. Each fit is shown from different orientation to approximate a three-dimensional view.

Electron density around ATP A 900:

$2mF_o-DF_c$ (at 0.7 rmsd) in gray
 mF_o-DF_c (at 3 rmsd) in purple (negative)
and green (positive)

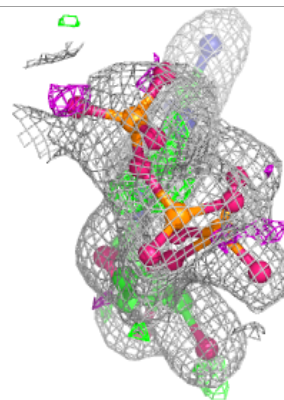
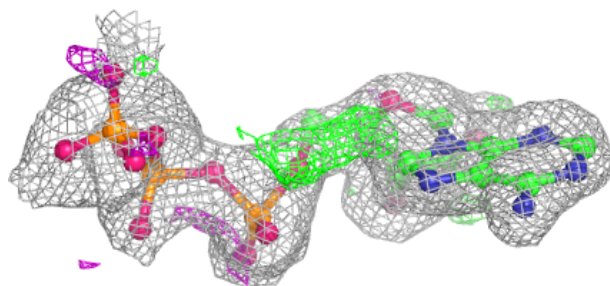
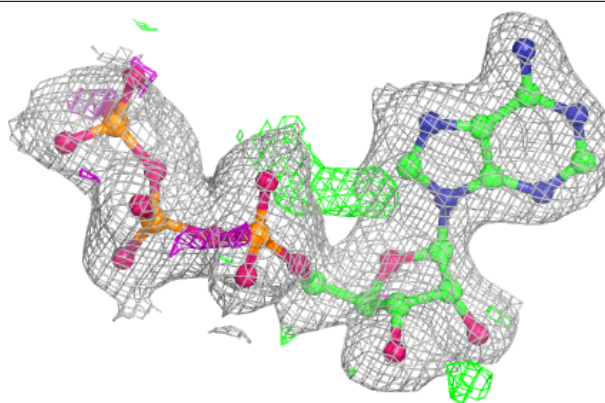
**Electron density around ATP D 900:**

$2mF_o-DF_c$ (at 0.7 rmsd) in gray
 mF_o-DF_c (at 3 rmsd) in purple (negative)
and green (positive)

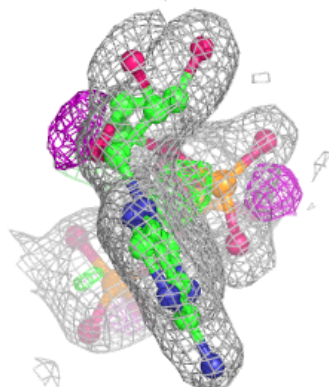
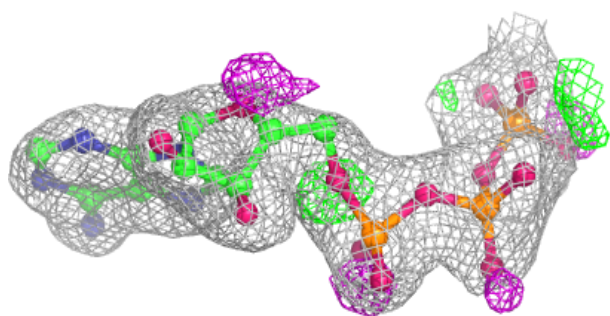
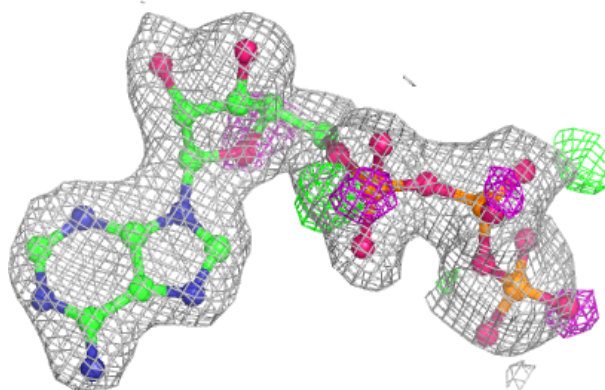

Electron density around ATP B 900:

$2mF_o-DF_c$ (at 0.7 rmsd) in gray
 mF_o-DF_c (at 3 rmsd) in purple (negative)
and green (positive)

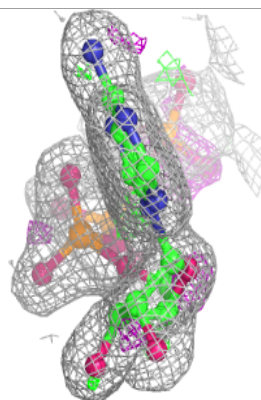
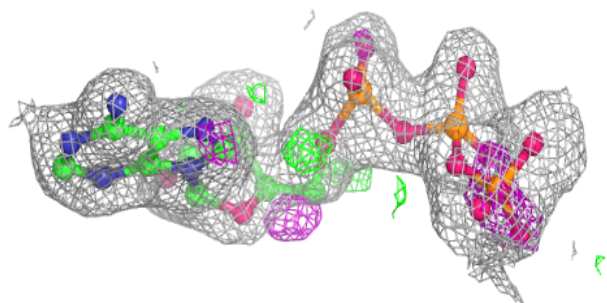
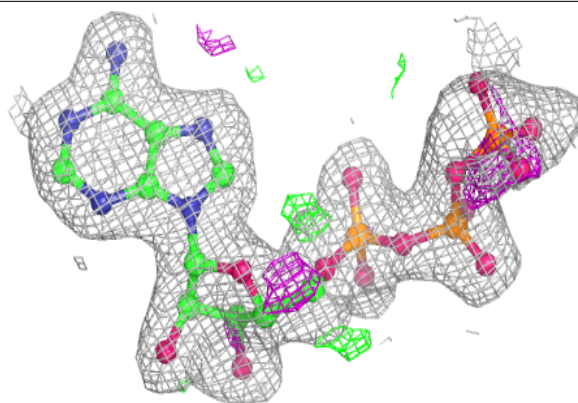
**Electron density around ATP C 900:**

$2mF_o-DF_c$ (at 0.7 rmsd) in gray
 mF_o-DF_c (at 3 rmsd) in purple (negative)
and green (positive)

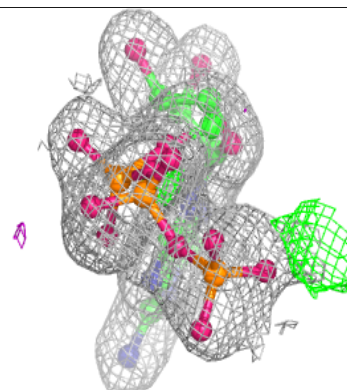
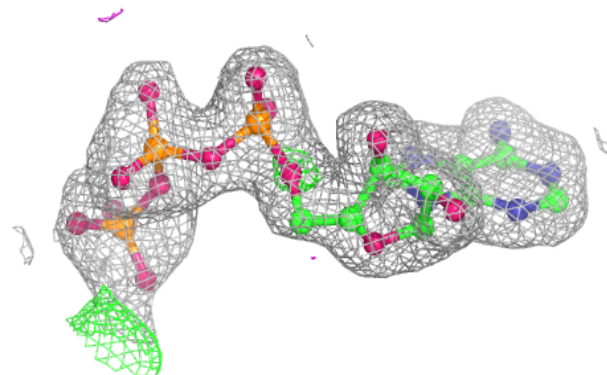
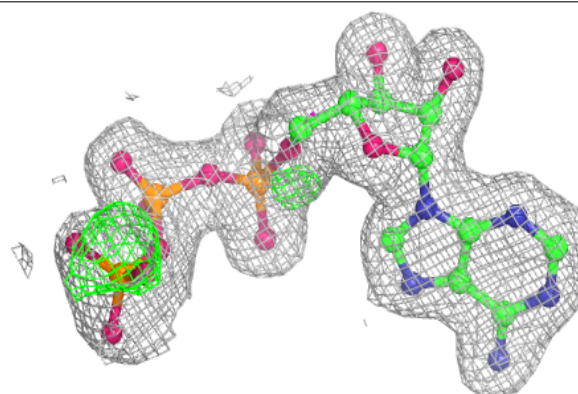

6.5 Other polymers [i](#)

There are no such residues in this entry.