



# Full wwPDB X-ray Structure Validation Report ⓘ

Mar 9, 2024 – 08:35 PM EST

PDB ID : 3GKQ  
Title : Terminal oxygenase of carbazole 1,9a-dioxygenase from *Novosphingobium* sp. KA1  
Authors : Umeda, T.; Nojiri, H.  
Deposited on : 2009-03-11  
Resolution : 2.10 Å (reported)

This is a Full wwPDB X-ray Structure Validation Report for a publicly released PDB entry.

We welcome your comments at [validation@mail.wwpdb.org](mailto:validation@mail.wwpdb.org)

A user guide is available at

<https://www.wwpdb.org/validation/2017/XrayValidationReportHelp>

with specific help available everywhere you see the ⓘ symbol.

The types of validation reports are described at

<http://www.wwpdb.org/validation/2017/FAQs#types>.

---

The following versions of software and data (see [references ⓘ](#)) were used in the production of this report:

MolProbity : 4.02b-467  
Mogul : 1.8.5 (274361), CSD as541be (2020)  
Xtriage (Phenix) : 1.13  
EDS : 2.36  
Percentile statistics : 20191225.v01 (using entries in the PDB archive December 25th 2019)  
Refmac : 5.8.0158  
CCP4 : 7.0.044 (Gargrove)  
Ideal geometry (proteins) : Engh & Huber (2001)  
Ideal geometry (DNA, RNA) : Parkinson et al. (1996)  
Validation Pipeline (wwPDB-VP) : 2.36

# 1 Overall quality at a glance

The following experimental techniques were used to determine the structure:

*X-RAY DIFFRACTION*

The reported resolution of this entry is 2.10 Å.

Percentile scores (ranging between 0-100) for global validation metrics of the entry are shown in the following graphic. The table shows the number of entries on which the scores are based.

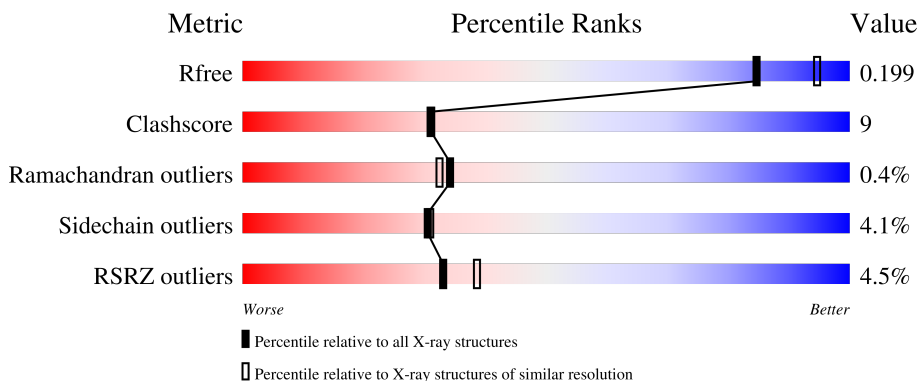

Metric	Whole archive (#Entries)	Similar resolution (#Entries, resolution range(Å))
$R_{free}$	130704	5197 (2.10-2.10)
Clashscore	141614	5710 (2.10-2.10)
Ramachandran outliers	138981	5647 (2.10-2.10)
Sidechain outliers	138945	5648 (2.10-2.10)
RSRZ outliers	127900	5083 (2.10-2.10)

The table below summarises the geometric issues observed across the polymeric chains and their fit to the electron density. The red, orange, yellow and green segments of the lower bar indicate the fraction of residues that contain outliers for  $\geq 3$ , 2, 1 and 0 types of geometric quality criteria respectively. A grey segment represents the fraction of residues that are not modelled. The numeric value for each fraction is indicated below the corresponding segment, with a dot representing fractions  $\leq 5\%$ . The upper red bar (where present) indicates the fraction of residues that have poor fit to the electron density. The numeric value is given above the bar.

Mol	Chain	Length	Quality of chain
1	A	389	
1	B	389	
1	C	389	
1	D	389	
1	E	389	

*Continued on next page...*

*Continued from previous page...*

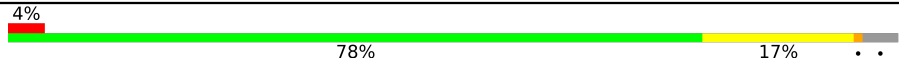
Mol	Chain	Length	Quality of chain
1	F	389	 4% 78% 17% ..

## 2 Entry composition [i](#)

There are 4 unique types of molecules in this entry. The entry contains 20106 atoms, of which 0 are hydrogens and 0 are deuteriums.

In the tables below, the ZeroOcc column contains the number of atoms modelled with zero occupancy, the AltConf column contains the number of residues with at least one atom in alternate conformation and the Trace column contains the number of residues modelled with at most 2 atoms.

- Molecule 1 is a protein called Terminal oxygenase component of carbazole 1,9a-dioxygenase.

Mol	Chain	Residues	Atoms					ZeroOcc	AltConf	Trace
			Total	C	N	O	S			
1	A	374	2981	1898	527	548	8	0	0	0
1	B	374	2981	1898	527	548	8	0	0	0
1	C	374	2981	1898	527	548	8	0	0	0
1	D	373	2973	1894	526	545	8	0	0	0
1	E	373	2973	1894	526	545	8	0	0	0
1	F	373	2973	1894	526	545	8	0	0	0

There are 36 discrepancies between the modelled and reference sequences:

Chain	Residue	Modelled	Actual	Comment	Reference
A	384	HIS	-	expression tag	UNP Q2PFA6
A	385	HIS	-	expression tag	UNP Q2PFA6
A	386	HIS	-	expression tag	UNP Q2PFA6
A	387	HIS	-	expression tag	UNP Q2PFA6
A	388	HIS	-	expression tag	UNP Q2PFA6
A	389	HIS	-	expression tag	UNP Q2PFA6
B	384	HIS	-	expression tag	UNP Q2PFA6
B	385	HIS	-	expression tag	UNP Q2PFA6
B	386	HIS	-	expression tag	UNP Q2PFA6
B	387	HIS	-	expression tag	UNP Q2PFA6
B	388	HIS	-	expression tag	UNP Q2PFA6
B	389	HIS	-	expression tag	UNP Q2PFA6
C	384	HIS	-	expression tag	UNP Q2PFA6
C	385	HIS	-	expression tag	UNP Q2PFA6
C	386	HIS	-	expression tag	UNP Q2PFA6
C	387	HIS	-	expression tag	UNP Q2PFA6
C	388	HIS	-	expression tag	UNP Q2PFA6

*Continued on next page...*

Continued from previous page...

Chain	Residue	Modelled	Actual	Comment	Reference
C	389	HIS	-	expression tag	UNP Q2PFA6
D	384	HIS	-	expression tag	UNP Q2PFA6
D	385	HIS	-	expression tag	UNP Q2PFA6
D	386	HIS	-	expression tag	UNP Q2PFA6
D	387	HIS	-	expression tag	UNP Q2PFA6
D	388	HIS	-	expression tag	UNP Q2PFA6
D	389	HIS	-	expression tag	UNP Q2PFA6
E	384	HIS	-	expression tag	UNP Q2PFA6
E	385	HIS	-	expression tag	UNP Q2PFA6
E	386	HIS	-	expression tag	UNP Q2PFA6
E	387	HIS	-	expression tag	UNP Q2PFA6
E	388	HIS	-	expression tag	UNP Q2PFA6
E	389	HIS	-	expression tag	UNP Q2PFA6
F	384	HIS	-	expression tag	UNP Q2PFA6
F	385	HIS	-	expression tag	UNP Q2PFA6
F	386	HIS	-	expression tag	UNP Q2PFA6
F	387	HIS	-	expression tag	UNP Q2PFA6
F	388	HIS	-	expression tag	UNP Q2PFA6
F	389	HIS	-	expression tag	UNP Q2PFA6

- Molecule 2 is FE (II) ION (three-letter code: FE2) (formula: Fe).

Mol	Chain	Residues	Atoms	ZeroOcc	AltConf
2	A	2	Total Fe 2 2	0	0
2	B	2	Total Fe 2 2	0	0
2	C	2	Total Fe 2 2	0	0
2	D	2	Total Fe 2 2	0	0
2	E	2	Total Fe 2 2	0	0
2	F	2	Total Fe 2 2	0	0

- Molecule 3 is FE2/S2 (INORGANIC) CLUSTER (three-letter code: FES) (formula: Fe<sub>2</sub>S<sub>2</sub>).



Mol	Chain	Residues	Atoms			ZeroOcc	AltConf
			Total	Fe	S		
3	A	1	4	2	2	0	0
3	B	1	4	2	2	0	0
3	C	1	4	2	2	0	0
3	D	1	4	2	2	0	0
3	E	1	4	2	2	0	0
3	F	1	4	2	2	0	0

- Molecule 4 is water.

Mol	Chain	Residues	Atoms		ZeroOcc	AltConf
			Total	O		
4	A	323	323	323	0	0
4	B	374	374	374	0	0
4	C	385	385	385	0	0
4	D	406	406	406	0	0
4	E	332	332	332	0	0
4	F	388	388	388	0	0

### 3 Residue-property plots

These plots are drawn for all protein, RNA, DNA and oligosaccharide chains in the entry. The first graphic for a chain summarises the proportions of the various outlier classes displayed in the second graphic. The second graphic shows the sequence view annotated by issues in geometry and electron density. Residues are color-coded according to the number of geometric quality criteria for which they contain at least one outlier: green = 0, yellow = 1, orange = 2 and red = 3 or more. A red dot above a residue indicates a poor fit to the electron density ( $RSRZ > 2$ ). Stretches of 2 or more consecutive residues without any outlier are shown as a green connector. Residues present in the sample, but not in the model, are shown in grey.

- Molecule 1: Terminal oxygenase component of carbazole 1,9a-dioxygenase

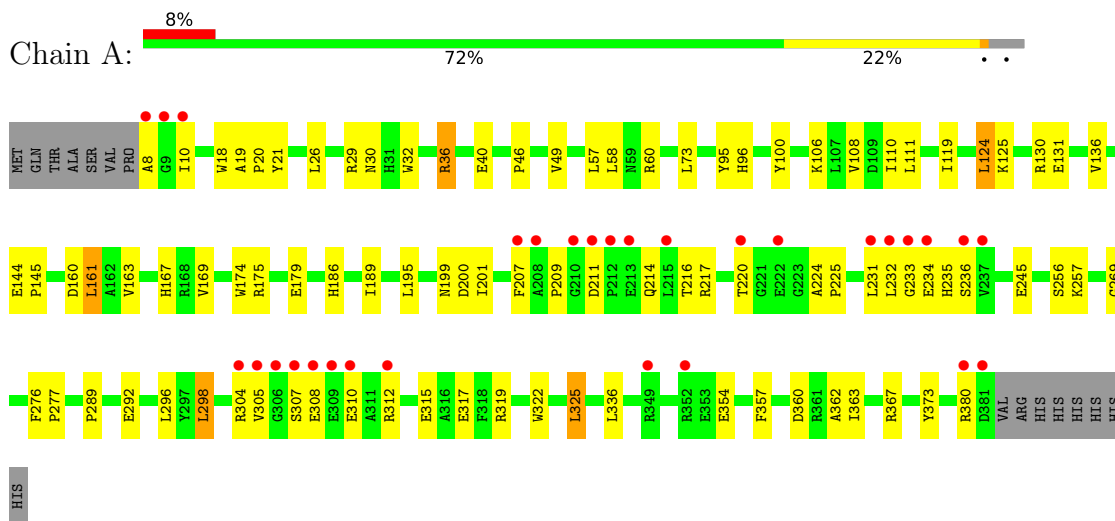

- Molecule 1: Terminal oxygenase component of carbazole 1,9a-dioxygenase

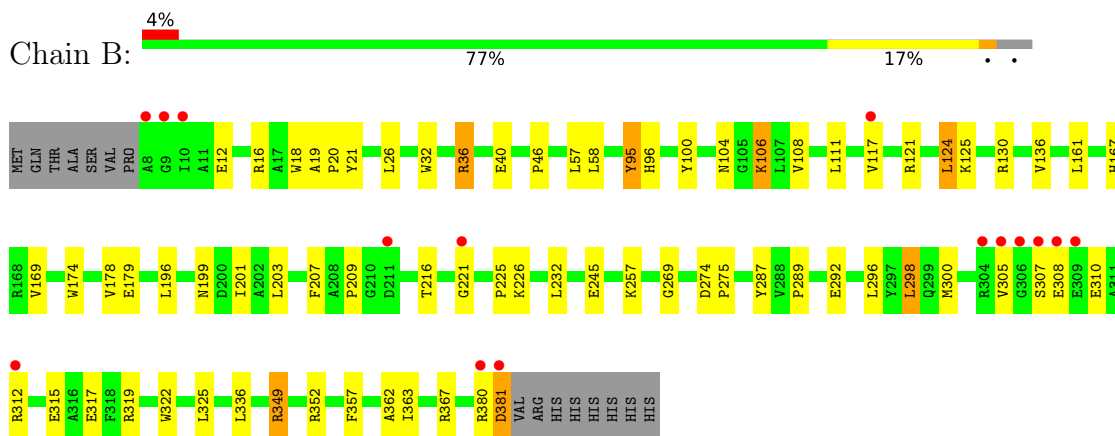

- Molecule 1: Terminal oxygenase component of carbazole 1,9a-dioxygenase

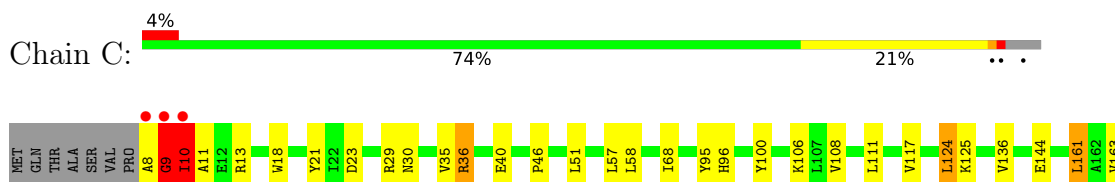

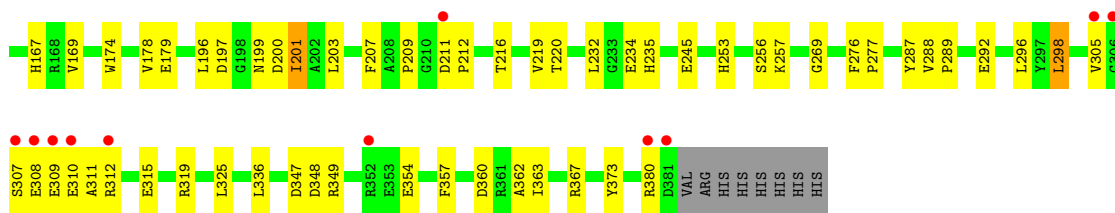

- Molecule 1: Terminal oxygenase component of carbazole 1,9a-dioxygenase

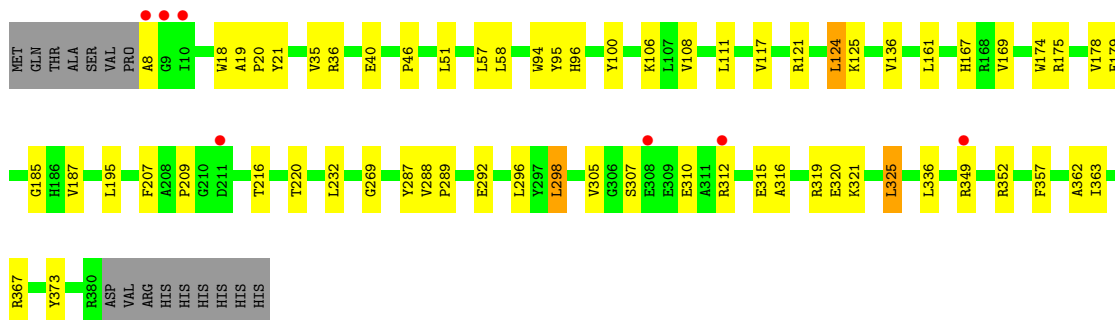
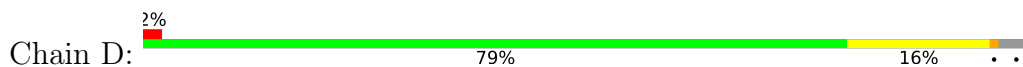

- Molecule 1: Terminal oxygenase component of carbazole 1,9a-dioxygenase

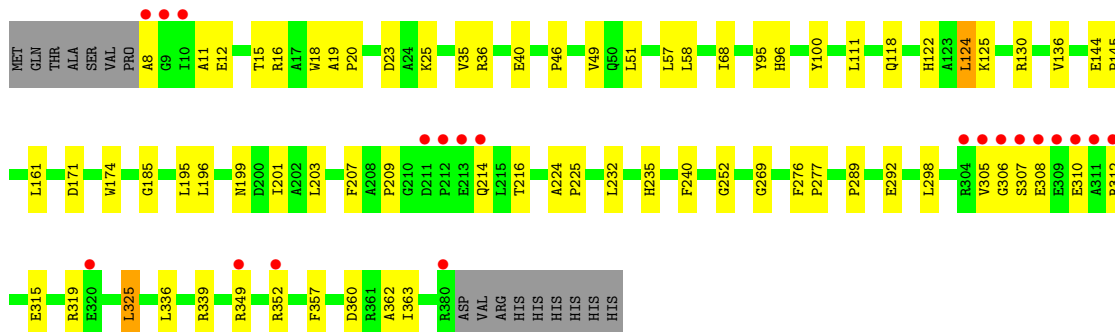
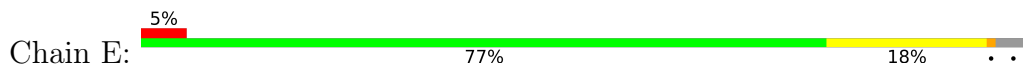

- Molecule 1: Terminal oxygenase component of carbazole 1,9a-dioxygenase

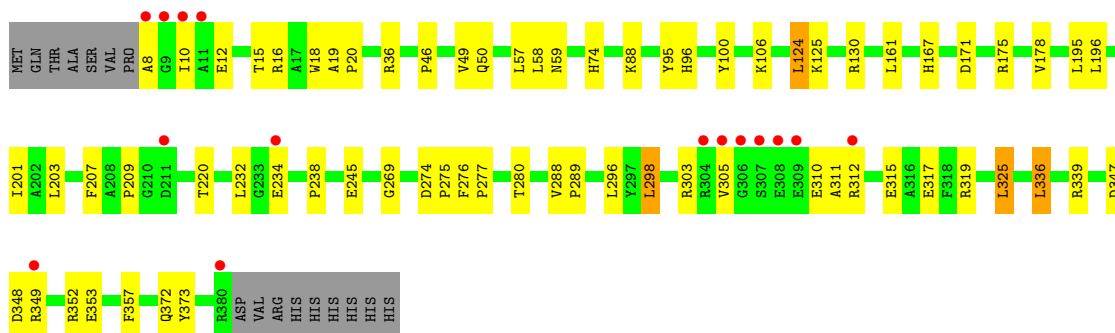
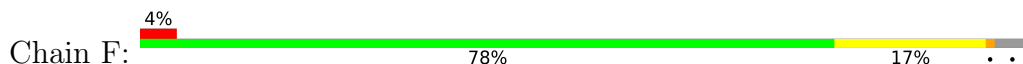



## 4 Data and refinement statistics

Property	Value	Source
Space group	P 1 21 1	Depositor
Cell constants a, b, c, $\alpha$ , $\beta$ , $\gamma$	117.15Å 159.02Å 167.77Å 90.00° 94.45° 90.00°	Depositor
Resolution (Å)	47.07 – 2.10 47.07 – 2.10	Depositor EDS
% Data completeness (in resolution range)	99.8 (47.07-2.10) 99.9 (47.07-2.10)	Depositor EDS
$R_{merge}$	0.07	Depositor
$R_{sym}$	(Not available)	Depositor
$\langle I/\sigma(I) \rangle$ <sup>1</sup>	3.77 (at 2.10Å)	Xtrriage
Refinement program	CNS	Depositor
R, $R_{free}$	0.201 , 0.436 0.197 , 0.199	Depositor DCC
$R_{free}$ test set	17887 reflections (5.04%)	wwPDB-VP
Wilson B-factor (Å <sup>2</sup> )	32.3	Xtrriage
Anisotropy	0.009	Xtrriage
Bulk solvent $k_{sol}$ (e/Å <sup>3</sup> ), $B_{sol}$ (Å <sup>2</sup> )	0.36 , 57.0	EDS
L-test for twinning <sup>2</sup>	$\langle  L  \rangle = 0.50$ , $\langle L^2 \rangle = 0.33$	Xtrriage
Estimated twinning fraction	No twinning to report.	Xtrriage
$F_o, F_c$ correlation	0.95	EDS
Total number of atoms	20106	wwPDB-VP
Average B, all atoms (Å <sup>2</sup> )	35.0	wwPDB-VP

Xtrriage's analysis on translational NCS is as follows: *The largest off-origin peak in the Patterson function is 2.71% of the height of the origin peak. No significant pseudotranslation is detected.*

<sup>1</sup>Intensities estimated from amplitudes.

<sup>2</sup>Theoretical values of  $\langle |L| \rangle$ ,  $\langle L^2 \rangle$  for acentric reflections are 0.5, 0.333 respectively for untwinned datasets, and 0.375, 0.2 for perfectly twinned datasets.

## 5 Model quality [i](#)

### 5.1 Standard geometry [i](#)

Bond lengths and bond angles in the following residue types are not validated in this section: FE2, FES

The Z score for a bond length (or angle) is the number of standard deviations the observed value is removed from the expected value. A bond length (or angle) with  $|Z| > 5$  is considered an outlier worth inspection. RMSZ is the root-mean-square of all Z scores of the bond lengths (or angles).

Mol	Chain	Bond lengths		Bond angles	
		RMSZ	# Z  >5	RMSZ	# Z  >5
1	A	0.32	0/3063	0.61	0/4166
1	B	0.32	0/3063	0.61	0/4166
1	C	0.41	2/3063 (0.1%)	0.70	5/4166 (0.1%)
1	D	0.33	0/3055	0.61	0/4155
1	E	0.32	0/3055	0.59	0/4155
1	F	0.33	0/3055	0.61	0/4155
All	All	0.34	2/18354 (0.0%)	0.62	5/24963 (0.0%)

Chiral center outliers are detected by calculating the chiral volume of a chiral center and verifying if the center is modelled as a planar moiety or with the opposite hand. A planarity outlier is detected by checking planarity of atoms in a peptide group, atoms in a mainchain group or atoms of a sidechain that are expected to be planar.

Mol	Chain	#Chirality outliers	#Planarity outliers
1	C	0	1

All (2) bond length outliers are listed below:

Mol	Chain	Res	Type	Atoms	Z	Observed(Å)	Ideal(Å)
1	C	9	GLY	C-O	-6.62	1.13	1.23
1	C	8	ALA	C-O	-6.33	1.11	1.23

All (5) bond angle outliers are listed below:

Mol	Chain	Res	Type	Atoms	Z	Observed( $^{\circ}$ )	Ideal( $^{\circ}$ )
1	C	9	GLY	N-CA-C	9.94	137.95	113.10
1	C	9	GLY	O-C-N	-9.27	107.87	122.70
1	C	9	GLY	CA-C-N	8.61	136.15	117.20
1	C	10	ILE	N-CA-CB	5.66	123.83	110.80
1	C	9	GLY	CA-C-O	-5.07	111.47	120.60

There are no chirality outliers.

All (1) planarity outliers are listed below:

Mol	Chain	Res	Type	Group
1	C	9	GLY	Mainchain

## 5.2 Too-close contacts [i](#)

In the following table, the Non-H and H(model) columns list the number of non-hydrogen atoms and hydrogen atoms in the chain respectively. The H(added) column lists the number of hydrogen atoms added and optimized by MolProbity. The Clashes column lists the number of clashes within the asymmetric unit, whereas Symm-Clashes lists symmetry-related clashes.

Mol	Chain	Non-H	H(model)	H(added)	Clashes	Symm-Clashes
1	A	2981	0	2881	74	0
1	B	2981	0	2881	58	0
1	C	2981	0	2881	60	0
1	D	2973	0	2877	46	0
1	E	2973	0	2877	48	0
1	F	2973	0	2877	47	0
2	A	2	0	0	0	0
2	B	2	0	0	0	0
2	C	2	0	0	0	0
2	D	2	0	0	0	0
2	E	2	0	0	0	0
2	F	2	0	0	0	0
3	A	4	0	0	1	0
3	B	4	0	0	1	0
3	C	4	0	0	1	0
3	D	4	0	0	1	0
3	E	4	0	0	1	0
3	F	4	0	0	1	0
4	A	323	0	0	7	0
4	B	374	0	0	5	0
4	C	385	0	0	6	0
4	D	406	0	0	6	0
4	E	332	0	0	4	0
4	F	388	0	0	9	0
All	All	20106	0	17274	321	0

The all-atom clashscore is defined as the number of clashes found per 1000 atoms (including hydrogen atoms). The all-atom clashscore for this structure is 9.

All (321) close contacts within the same asymmetric unit are listed below, sorted by their clash

magnitude.

Atom-1	Atom-2	Interatomic distance (Å)	Clash overlap (Å)
1:D:305:VAL:HG13	1:D:310:GLU:HG3	1.31	1.11
1:C:305:VAL:HG13	1:C:310:GLU:HG3	1.45	0.99
1:B:305:VAL:HG13	1:B:310:GLU:HG3	1.48	0.95
1:A:305:VAL:HG13	1:A:310:GLU:HG3	1.49	0.92
1:B:308:GLU:HG3	1:B:312:ARG:NH1	1.88	0.89
1:E:305:VAL:HG13	1:E:310:GLU:HB2	1.54	0.88
1:E:308:GLU:HG3	1:E:312:ARG:HH12	1.41	0.84
1:C:308:GLU:HG3	1:C:312:ARG:HH11	1.47	0.79
1:A:125:LYS:HE2	4:A:1964:HOH:O	1.82	0.78
1:F:305:VAL:HG13	1:F:310:GLU:HG3	1.64	0.78
1:E:125:LYS:HE2	4:E:1978:HOH:O	1.85	0.76
1:C:10:ILE:HG12	1:C:13:ARG:NH2	2.01	0.76
1:B:308:GLU:HG3	1:B:312:ARG:HH12	1.49	0.76
1:A:199:ASN:HD22	1:A:201:ILE:HD11	1.52	0.75
1:B:225:PRO:HA	4:B:781:HOH:O	1.85	0.74
1:F:130:ARG:NH1	4:F:2204:HOH:O	2.22	0.73
1:E:207:PHE:O	1:E:209:PRO:HD3	1.90	0.72
1:A:233:GLY:HA2	4:A:1995:HOH:O	1.88	0.71
1:D:36:ARG:HG3	1:D:40:GLU:OE1	1.90	0.71
1:F:349:ARG:HD3	1:F:353:GLU:OE2	1.91	0.70
1:B:245:GLU:HG2	1:C:108:VAL:HG11	1.73	0.70
1:A:199:ASN:HB3	1:A:201:ILE:HD13	1.74	0.70
1:E:36:ARG:HG3	1:E:40:GLU:OE1	1.91	0.70
1:A:160:ASP:OD2	1:A:304:ARG:HG3	1.92	0.69
1:A:186:HIS:O	1:A:189:ILE:HG12	1.93	0.69
1:B:36:ARG:HG3	1:B:40:GLU:OE1	1.94	0.68
1:E:36:ARG:O	1:E:136:VAL:HG12	1.93	0.68
1:C:308:GLU:HG3	1:C:312:ARG:NH1	2.08	0.68
1:D:125:LYS:HE2	4:D:454:HOH:O	1.94	0.67
1:A:36:ARG:HG3	1:A:40:GLU:OE1	1.95	0.66
1:C:36:ARG:HG3	1:C:40:GLU:OE1	1.95	0.66
1:B:36:ARG:O	1:B:136:VAL:HG12	1.95	0.66
1:A:36:ARG:O	1:A:136:VAL:HG12	1.96	0.66
1:E:185:GLY:HA2	4:E:1980:HOH:O	1.95	0.66
1:B:315:GLU:OE2	1:B:319:ARG:HD3	1.96	0.66
1:F:125:LYS:HE2	4:F:1951:HOH:O	1.96	0.65
1:E:352:ARG:HG2	1:E:352:ARG:HH11	1.63	0.64
1:D:108:VAL:HG11	1:F:245:GLU:HG2	1.79	0.63
1:C:234:GLU:HG3	1:C:235:HIS:CD2	2.34	0.63
1:F:106:LYS:HE3	4:F:2126:HOH:O	1.98	0.63
1:A:21:TYR:CE2	1:A:367:ARG:HD2	2.33	0.63

*Continued on next page...*

*Continued from previous page...*

Atom-1	Atom-2	Interatomic distance (Å)	Clash overlap (Å)
1:A:108:VAL:HG21	1:C:245:GLU:HG2	1.80	0.63
1:A:209:PRO:HG3	1:A:232:LEU:HD21	1.80	0.62
1:F:96:HIS:HB2	3:F:502:FES:S1	2.40	0.62
1:E:352:ARG:HG3	4:E:2165:HOH:O	1.98	0.61
1:C:292:GLU:OE2	1:C:380:ARG:NH1	2.33	0.61
1:F:10:ILE:HD12	4:F:1183:HOH:O	1.99	0.61
1:B:12:GLU:OE2	1:B:16:ARG:HD3	2.00	0.61
1:C:207:PHE:O	1:C:209:PRO:HD3	2.00	0.61
1:E:12:GLU:OE2	1:E:16:ARG:HD3	2.01	0.61
1:B:169:VAL:HG12	4:B:403:HOH:O	2.00	0.61
1:F:36:ARG:NH1	1:F:49:VAL:HG12	2.14	0.61
1:B:21:TYR:CE2	1:B:367:ARG:HD2	2.36	0.60
1:C:125:LYS:HE2	4:C:1620:HOH:O	2.00	0.60
1:F:303:ARG:NH2	1:F:317:GLU:OE1	2.35	0.60
1:B:363:ILE:O	1:B:367:ARG:HG3	2.02	0.60
1:A:308:GLU:HG3	1:A:312:ARG:NH1	2.16	0.59
1:B:199:ASN:HB3	1:B:201:ILE:HD13	1.84	0.59
1:C:347:ASP:OD2	1:C:349:ARG:HD3	2.02	0.59
1:D:363:ILE:O	1:D:367:ARG:HG3	2.03	0.59
1:B:221:GLY:HA3	1:B:226:LYS:HE3	1.85	0.59
1:A:60:ARG:NH2	1:A:131:GLU:OE1	2.36	0.59
1:C:9:GLY:HA2	1:C:11:ALA:H	1.66	0.58
1:D:36:ARG:O	1:D:136:VAL:HG12	2.01	0.58
1:F:12:GLU:OE2	1:F:16:ARG:HD3	2.03	0.58
1:F:50:GLN:HB2	4:F:1162:HOH:O	2.01	0.58
1:A:169:VAL:HG21	4:A:894:HOH:O	2.04	0.58
1:A:224:ALA:HB1	1:A:225:PRO:HD2	1.85	0.58
1:B:221:GLY:N	1:B:226:LYS:HG2	2.19	0.58
1:D:106:LYS:HD3	4:D:1297:HOH:O	2.04	0.58
1:D:352:ARG:HH11	1:D:352:ARG:HG2	1.67	0.57
1:A:199:ASN:ND2	1:A:201:ILE:HD11	2.17	0.57
1:F:305:VAL:HG13	1:F:310:GLU:CG	2.33	0.57
1:D:307:SER:OG	1:D:310:GLU:HG2	2.05	0.57
1:B:380:ARG:O	1:B:381:ASP:HB2	2.05	0.57
1:C:308:GLU:O	1:C:312:ARG:HG3	2.05	0.57
1:E:216:THR:HG21	1:E:362:ALA:HA	1.87	0.57
1:A:207:PHE:O	1:A:209:PRO:HD3	2.04	0.56
1:F:220:THR:O	1:F:220:THR:CG2	2.53	0.56
1:C:10:ILE:HG12	1:C:13:ARG:HH22	1.70	0.56
1:E:130:ARG:NH1	4:E:2016:HOH:O	2.39	0.56
1:E:312:ARG:HB2	1:E:312:ARG:NH1	2.20	0.56

*Continued on next page...*

*Continued from previous page...*

Atom-1	Atom-2	Interatomic distance (Å)	Clash overlap (Å)
1:A:60:ARG:HH22	1:A:131:GLU:CD	2.08	0.56
1:B:199:ASN:HD22	1:B:201:ILE:HD11	1.69	0.56
1:C:292:GLU:CD	1:C:292:GLU:H	2.07	0.56
1:A:96:HIS:HB2	3:A:502:FES:S1	2.45	0.56
1:C:9:GLY:HA2	1:C:11:ALA:N	2.21	0.56
1:E:195:LEU:HA	1:E:325:LEU:CD2	2.36	0.56
1:C:220:THR:CG2	1:C:220:THR:O	2.53	0.55
1:E:171:ASP:HB2	1:E:339:ARG:NH1	2.20	0.55
1:D:167:HIS:HB3	1:D:298:LEU:HD23	1.88	0.55
1:A:307:SER:OG	1:A:310:GLU:HG2	2.07	0.55
1:B:207:PHE:O	1:B:209:PRO:HD3	2.06	0.55
1:E:196:LEU:HD21	1:E:203:LEU:HD22	1.88	0.54
1:D:207:PHE:O	1:D:209:PRO:HD3	2.08	0.54
1:A:315:GLU:OE2	1:A:319:ARG:HD3	2.07	0.54
1:D:167:HIS:HB2	1:D:296:LEU:HD11	1.89	0.54
1:E:349:ARG:HA	1:E:349:ARG:NE	2.23	0.54
1:F:305:VAL:HG11	1:F:311:ALA:HB2	1.90	0.53
1:A:214:GLN:NE2	1:A:235:HIS:NE2	2.57	0.53
1:E:96:HIS:HB2	3:E:502:FES:S1	2.48	0.53
1:D:94:TRP:CH2	1:F:336:LEU:HD13	2.44	0.53
1:D:349:ARG:NH2	1:D:352:ARG:HG3	2.24	0.53
1:C:136:VAL:HG23	1:C:136:VAL:O	2.09	0.53
1:D:179:GLU:OE2	1:D:367:ARG:HD3	2.09	0.53
1:B:196:LEU:HD21	1:B:203:LEU:HD22	1.91	0.53
1:B:46:PRO:HA	1:B:58:LEU:O	2.09	0.53
1:C:199:ASN:HD22	1:C:201:ILE:HD13	1.74	0.52
1:E:15:THR:HG21	1:E:352:ARG:HD3	1.91	0.52
1:F:238:PRO:HD3	4:F:1801:HOH:O	2.10	0.52
1:A:363:ILE:O	1:A:367:ARG:HG3	2.08	0.52
1:F:207:PHE:O	1:F:209:PRO:HD3	2.09	0.52
1:D:21:TYR:CE2	1:D:367:ARG:HD2	2.45	0.52
1:E:118:GLN:NE2	1:E:122:HIS:NE2	2.57	0.52
1:A:232:LEU:HD23	1:A:236:SER:HB3	1.90	0.52
1:C:216:THR:HG21	1:C:362:ALA:HA	1.91	0.52
1:C:169:VAL:HG22	4:C:426:HOH:O	2.10	0.52
1:B:292:GLU:CD	1:B:292:GLU:H	2.12	0.52
1:D:349:ARG:HA	1:D:349:ARG:NE	2.24	0.52
1:B:167:HIS:HB2	1:B:296:LEU:HD11	1.91	0.51
1:D:96:HIS:HB2	3:D:502:FES:S1	2.50	0.51
1:B:96:HIS:HB2	3:B:502:FES:S1	2.50	0.51
1:D:315:GLU:OE2	1:D:319:ARG:HD3	2.10	0.51

*Continued on next page...*

*Continued from previous page...*

Atom-1	Atom-2	Interatomic distance (Å)	Clash overlap (Å)
1:C:197:ASP:OD1	1:C:253:HIS:HE1	1.93	0.51
1:C:315:GLU:OE2	1:C:319:ARG:HD3	2.09	0.51
1:C:201:ILE:HD12	1:C:257:LYS:HB2	1.92	0.51
1:C:179:GLU:OE2	1:C:367:ARG:HD2	2.10	0.51
1:D:292:GLU:CD	1:D:292:GLU:H	2.14	0.51
1:B:178:VAL:HG22	1:B:287:TYR:CD2	2.46	0.51
1:A:161:LEU:HD13	1:A:163:VAL:CG2	2.40	0.51
1:E:8:ALA:HB1	1:E:11:ALA:HB3	1.93	0.51
1:E:307:SER:OG	1:E:310:GLU:HG3	2.10	0.51
1:A:199:ASN:O	1:A:201:ILE:HD12	2.11	0.50
1:B:32:TRP:CH2	1:B:130:ARG:HG3	2.46	0.50
1:B:199:ASN:ND2	1:B:201:ILE:HD11	2.26	0.50
1:C:21:TYR:CD2	1:C:367:ARG:HG2	2.46	0.50
1:F:220:THR:O	1:F:220:THR:HG22	2.11	0.50
1:A:199:ASN:HD22	1:A:201:ILE:CD1	2.24	0.50
1:B:179:GLU:OE2	1:B:367:ARG:HD3	2.11	0.50
1:C:199:ASN:ND2	1:C:201:ILE:HD13	2.26	0.50
1:A:231:LEU:HA	4:A:2028:HOH:O	2.11	0.50
1:D:117:VAL:HG22	1:D:121:ARG:CZ	2.41	0.50
1:C:100:TYR:CE2	1:C:124:LEU:HD13	2.47	0.50
1:D:46:PRO:HA	1:D:58:LEU:O	2.12	0.50
1:A:360:ASP:O	1:A:363:ILE:HG22	2.10	0.49
1:E:35:VAL:CG1	1:E:51:LEU:HD13	2.42	0.49
1:E:46:PRO:HA	1:E:58:LEU:O	2.13	0.49
1:E:224:ALA:HB1	1:E:225:PRO:HD2	1.93	0.49
1:B:104:ASN:OD1	1:B:106:LYS:HB2	2.13	0.49
1:D:167:HIS:HB2	1:D:296:LEU:CD1	2.43	0.49
1:D:316:ALA:O	1:D:320:GLU:HG3	2.13	0.49
1:A:8:ALA:HB1	1:A:10:ILE:HG22	1.95	0.49
1:D:185:GLY:HA2	4:D:2031:HOH:O	2.13	0.49
1:B:349:ARG:HH11	1:B:349:ARG:HB2	1.78	0.48
1:B:352:ARG:HG3	4:B:1056:HOH:O	2.13	0.48
1:C:35:VAL:CG1	1:C:51:LEU:HD13	2.43	0.48
1:E:315:GLU:OE2	1:E:319:ARG:HD3	2.13	0.48
1:A:195:LEU:HA	1:A:325:LEU:HD22	1.96	0.48
1:F:88:LYS:HE3	4:F:586:HOH:O	2.14	0.48
1:A:317:GLU:HG2	1:A:322:TRP:CD1	2.48	0.48
1:A:362:ALA:HB3	4:A:415:HOH:O	2.13	0.48
1:D:100:TYR:CE2	1:D:124:LEU:HD13	2.48	0.48
1:E:100:TYR:CE2	1:E:124:LEU:HD13	2.49	0.47
1:A:245:GLU:HG2	1:B:108:VAL:HG21	1.96	0.47

*Continued on next page...*

*Continued from previous page...*

Atom-1	Atom-2	Interatomic distance (Å)	Clash overlap (Å)
1:F:167:HIS:HB3	1:F:298:LEU:HD23	1.95	0.47
1:A:36:ARG:NH1	1:A:49:VAL:HG12	2.29	0.47
1:B:125:LYS:HE2	4:B:1962:HOH:O	2.13	0.47
1:C:46:PRO:HA	1:C:58:LEU:O	2.15	0.47
1:B:199:ASN:HD22	1:B:201:ILE:CD1	2.27	0.47
1:D:169:VAL:HG23	4:D:1554:HOH:O	2.13	0.47
1:D:187:VAL:HG22	4:D:2031:HOH:O	2.14	0.47
1:E:305:VAL:CG1	1:E:310:GLU:HB2	2.36	0.47
1:A:46:PRO:HA	1:A:58:LEU:O	2.14	0.47
1:E:305:VAL:HG12	1:E:307:SER:H	1.79	0.47
1:A:179:GLU:OE2	1:A:367:ARG:HD3	2.15	0.47
1:C:309:GLU:HA	1:C:312:ARG:NH1	2.29	0.47
1:C:347:ASP:O	1:C:348:ASP:HB2	2.14	0.47
1:A:32:TRP:CH2	1:A:130:ARG:HG2	2.50	0.47
1:A:186:HIS:HD2	1:A:189:ILE:HD11	1.80	0.47
1:C:167:HIS:HB3	1:C:298:LEU:HD23	1.97	0.47
1:E:199:ASN:HD22	1:E:201:ILE:HD11	1.79	0.47
1:F:171:ASP:HB2	1:F:339:ARG:NH1	2.30	0.47
1:E:292:GLU:H	1:E:292:GLU:CD	2.18	0.47
1:A:199:ASN:O	1:A:257:LYS:HD2	2.15	0.46
1:E:312:ARG:HB2	1:E:312:ARG:HH11	1.80	0.46
1:E:25:LYS:HG2	1:E:292:GLU:HB3	1.96	0.46
1:F:352:ARG:HD3	1:F:352:ARG:N	2.30	0.46
1:B:216:THR:HG21	1:B:362:ALA:HA	1.98	0.46
1:E:68:ILE:HD12	1:E:124:LEU:HD23	1.98	0.46
1:A:167:HIS:HB3	1:A:298:LEU:HD23	1.98	0.46
1:D:19:ALA:HB3	1:D:20:PRO:HD3	1.98	0.46
1:C:167:HIS:HB2	1:C:296:LEU:HD11	1.97	0.46
1:E:360:ASP:O	1:E:363:ILE:HG22	2.15	0.46
1:F:274:ASP:HA	1:F:275:PRO:HA	1.86	0.46
1:A:234:GLU:O	1:A:234:GLU:HG2	2.17	0.45
1:C:307:SER:OG	1:C:310:GLU:HG2	2.16	0.45
1:D:167:HIS:CB	1:D:296:LEU:HD11	2.46	0.45
1:F:234:GLU:O	1:F:234:GLU:HG2	2.15	0.45
1:B:307:SER:OG	1:B:310:GLU:HG2	2.16	0.45
1:E:305:VAL:HG13	1:E:310:GLU:CB	2.36	0.45
1:A:231:LEU:HD23	4:A:2028:HOH:O	2.17	0.45
1:C:117:VAL:O	1:C:117:VAL:HG22	2.17	0.45
1:D:321:LYS:O	1:D:325:LEU:HB2	2.17	0.45
1:A:234:GLU:C	1:A:235:HIS:ND1	2.69	0.45
1:B:174:TRP:CG	1:B:289:PRO:HG3	2.52	0.45

*Continued on next page...*



*Continued from previous page...*

Atom-1	Atom-2	Interatomic distance (Å)	Clash overlap (Å)
1:B:221:GLY:H	1:B:226:LYS:HG2	1.82	0.45
1:C:178:VAL:HG22	1:C:287:TYR:CD2	2.52	0.45
1:F:175:ARG:HA	1:F:178:VAL:HG12	1.99	0.45
1:B:245:GLU:CG	1:C:108:VAL:HG11	2.45	0.45
1:D:174:TRP:CE2	1:D:175:ARG:HG3	2.52	0.45
1:A:174:TRP:CG	1:A:289:PRO:HG3	2.51	0.45
1:A:186:HIS:HB2	1:B:95:TYR:HE1	1.82	0.45
1:B:221:GLY:N	4:B:1792:HOH:O	2.45	0.45
1:D:312:ARG:NH1	1:D:312:ARG:HB2	2.31	0.45
1:F:315:GLU:OE2	1:F:319:ARG:HD3	2.17	0.45
1:C:200:ASP:OD2	1:C:256:SER:HB2	2.17	0.44
1:A:308:GLU:HG3	1:A:312:ARG:HH11	1.82	0.44
1:E:308:GLU:CG	1:E:312:ARG:HH12	2.19	0.44
1:B:298:LEU:HD22	1:B:300:MET:SD	2.58	0.44
1:C:305:VAL:HG11	1:C:311:ALA:HB2	1.99	0.44
1:D:178:VAL:HG22	1:D:287:TYR:CD2	2.52	0.44
1:E:19:ALA:N	1:E:20:PRO:CD	2.80	0.44
1:F:8:ALA:HB1	1:F:10:ILE:HG22	2.00	0.44
1:A:108:VAL:CG2	1:C:245:GLU:HG2	2.48	0.44
1:A:317:GLU:HG2	1:A:322:TRP:NE1	2.33	0.44
1:B:108:VAL:HG22	1:B:108:VAL:O	2.17	0.44
1:D:220:THR:OG1	1:D:373:TYR:CZ	2.66	0.44
1:D:349:ARG:HH22	1:D:352:ARG:HG3	1.83	0.44
1:F:372:GLN:NE2	4:F:2044:HOH:O	2.51	0.44
1:A:199:ASN:HB3	1:A:201:ILE:CD1	2.46	0.44
1:C:220:THR:HG21	1:C:373:TYR:OH	2.17	0.44
1:C:96:HIS:HB2	3:C:502:FES:S1	2.58	0.44
1:C:161:LEU:HD13	1:C:163:VAL:CG2	2.48	0.44
1:E:240:PHE:O	1:E:252:GLY:N	2.42	0.44
1:D:288:VAL:HA	1:D:289:PRO:HD3	1.92	0.43
1:F:201:ILE:HD11	1:F:277:PRO:O	2.17	0.43
1:B:100:TYR:CE2	1:B:124:LEU:HD13	2.54	0.43
1:A:216:THR:HG21	1:A:362:ALA:HA	2.01	0.43
1:A:354:GLU:OE2	1:A:367:ARG:NH2	2.48	0.43
1:C:360:ASP:O	1:C:363:ILE:HG22	2.18	0.43
1:D:195:LEU:HA	1:D:325:LEU:HD22	2.01	0.43
1:F:59:ASN:HA	4:F:2040:HOH:O	2.17	0.43
1:B:100:TYR:HA	1:B:106:LYS:O	2.18	0.43
1:C:106:LYS:HE2	4:C:2052:HOH:O	2.18	0.43
1:F:100:TYR:CE2	1:F:124:LEU:HD13	2.54	0.43
1:F:280:THR:HB	1:F:303:ARG:NH1	2.33	0.43

*Continued on next page...*

*Continued from previous page...*

Atom-1	Atom-2	Interatomic distance (Å)	Clash overlap (Å)
1:A:106:LYS:HE2	4:C:680:HOH:O	2.19	0.43
1:A:110:ILE:HG13	1:A:119:ILE:HG12	2.01	0.43
1:F:349:ARG:HA	1:F:349:ARG:NE	2.34	0.43
1:C:196:LEU:HD21	1:C:203:LEU:HD22	2.00	0.43
1:C:354:GLU:OE2	1:C:367:ARG:NH2	2.46	0.43
1:C:211:ASP:OD1	1:C:212:PRO:HD2	2.18	0.43
1:D:8:ALA:HA	4:D:2101:HOH:O	2.18	0.43
1:C:174:TRP:CG	1:C:289:PRO:HG3	2.54	0.43
1:E:195:LEU:CD1	1:E:325:LEU:HD22	2.49	0.43
1:A:29:ARG:O	1:A:30:ASN:HB2	2.19	0.42
1:A:233:GLY:C	1:A:235:HIS:H	2.22	0.42
1:F:15:THR:HG21	1:F:352:ARG:CD	2.49	0.42
1:C:288:VAL:HA	1:C:289:PRO:HD3	1.90	0.42
1:D:108:VAL:HG11	1:F:245:GLU:CG	2.48	0.42
1:D:216:THR:HG21	1:D:362:ALA:HA	2.01	0.42
1:E:174:TRP:CG	1:E:289:PRO:HG3	2.54	0.42
1:A:26:LEU:HD12	1:A:26:LEU:HA	1.93	0.42
1:D:220:THR:OG1	1:D:220:THR:O	2.37	0.42
1:F:195:LEU:HA	1:F:325:LEU:HD22	2.00	0.42
1:A:211:ASP:OD2	1:A:214:GLN:HB2	2.19	0.42
1:B:167:HIS:CB	1:B:296:LEU:HD11	2.50	0.42
1:A:200:ASP:OD2	1:A:256:SER:HB2	2.19	0.42
1:C:219:VAL:HG12	4:C:2202:HOH:O	2.20	0.42
1:F:220:THR:HG23	1:F:373:TYR:CZ	2.54	0.42
1:A:167:HIS:HB2	1:A:296:LEU:HD11	2.01	0.42
1:E:352:ARG:HG2	1:E:352:ARG:NH1	2.32	0.42
1:A:220:THR:OG1	1:A:373:TYR:CZ	2.67	0.42
1:D:174:TRP:CG	1:D:289:PRO:HG3	2.55	0.42
1:E:305:VAL:HG12	1:E:306:GLY:N	2.34	0.42
1:A:100:TYR:CG	1:A:124:LEU:HD22	2.55	0.42
1:A:217:ARG:HB2	1:A:231:LEU:HD11	2.01	0.42
1:B:19:ALA:N	1:B:20:PRO:CD	2.82	0.42
1:D:352:ARG:HG2	1:D:352:ARG:NH1	2.33	0.42
1:C:276:PHE:CG	1:C:277:PRO:HA	2.55	0.42
1:D:35:VAL:CG1	1:D:51:LEU:HD13	2.50	0.42
1:E:214:GLN:HB3	1:E:235:HIS:CD2	2.55	0.42
1:F:276:PHE:CG	1:F:277:PRO:HA	2.55	0.42
1:D:100:TYR:CG	1:D:124:LEU:HD22	2.55	0.41
1:F:312:ARG:NH1	1:F:312:ARG:HB2	2.35	0.41
1:A:73:LEU:HG	1:A:124:LEU:CD1	2.51	0.41
1:A:108:VAL:HG21	1:C:245:GLU:CG	2.49	0.41

*Continued on next page...*

*Continued from previous page...*

Atom-1	Atom-2	Interatomic distance (Å)	Clash overlap (Å)
1:A:144:GLU:HA	1:A:145:PRO:HD3	1.93	0.41
1:C:68:ILE:HD12	1:C:124:LEU:HD23	2.02	0.41
1:E:36:ARG:NH1	1:E:49:VAL:HG12	2.35	0.41
1:F:8:ALA:HB1	1:F:10:ILE:CG2	2.50	0.41
1:A:292:GLU:OE2	1:A:380:ARG:HD2	2.21	0.41
1:C:349:ARG:HD2	4:C:2010:HOH:O	2.19	0.41
1:A:19:ALA:N	1:A:20:PRO:CD	2.84	0.41
1:B:106:LYS:HE3	1:B:106:LYS:HB3	1.89	0.41
1:B:349:ARG:HH11	1:B:349:ARG:CB	2.33	0.41
1:E:144:GLU:OE2	1:E:145:PRO:HD2	2.21	0.41
1:B:167:HIS:HB2	1:B:296:LEU:CD1	2.50	0.41
1:B:26:LEU:HD12	1:B:26:LEU:HA	1.93	0.41
1:B:199:ASN:O	1:B:257:LYS:HD2	2.20	0.41
1:F:19:ALA:HB3	1:F:20:PRO:HD3	2.03	0.41
1:F:347:ASP:O	1:F:348:ASP:HB2	2.20	0.41
1:A:199:ASN:ND2	1:A:201:ILE:CD1	2.82	0.41
1:E:195:LEU:HA	1:E:325:LEU:HD21	2.02	0.41
1:C:29:ARG:O	1:C:30:ASN:HB2	2.21	0.41
1:C:167:HIS:HB2	1:C:296:LEU:CD1	2.51	0.41
1:F:288:VAL:HA	1:F:289:PRO:HD3	1.92	0.41
1:A:186:HIS:HB2	1:B:95:TYR:CE1	2.56	0.40
1:A:174:TRP:CE2	1:A:175:ARG:HG3	2.56	0.40
1:A:233:GLY:HA3	4:A:1525:HOH:O	2.20	0.40
1:B:274:ASP:HA	1:B:275:PRO:HA	1.87	0.40
1:F:196:LEU:HD21	1:F:203:LEU:HD22	2.02	0.40
1:A:276:PHE:CG	1:A:277:PRO:HA	2.56	0.40
1:F:46:PRO:HA	1:F:58:LEU:O	2.22	0.40
1:B:245:GLU:HG2	1:C:108:VAL:CG1	2.47	0.40
1:B:100:TYR:CG	1:B:124:LEU:HD22	2.57	0.40
1:B:117:VAL:O	1:B:117:VAL:HG12	2.22	0.40
1:B:199:ASN:O	1:B:201:ILE:HD12	2.22	0.40
1:B:317:GLU:HG2	1:B:322:TRP:CD1	2.57	0.40
1:E:276:PHE:CG	1:E:277:PRO:HA	2.57	0.40
1:F:220:THR:HG21	1:F:373:TYR:OH	2.22	0.40

There are no symmetry-related clashes.

## 5.3 Torsion angles [i](#)

### 5.3.1 Protein backbone [i](#)

In the following table, the Percentiles column shows the percent Ramachandran outliers of the chain as a percentile score with respect to all X-ray entries followed by that with respect to entries of similar resolution.

The Analysed column shows the number of residues for which the backbone conformation was analysed, and the total number of residues.

Mol	Chain	Analysed	Favoured	Allowed	Outliers	Percentiles	
1	A	372/389 (96%)	348 (94%)	23 (6%)	1 (0%)	41	41
1	B	372/389 (96%)	350 (94%)	21 (6%)	1 (0%)	41	41
1	C	372/389 (96%)	348 (94%)	22 (6%)	2 (0%)	29	26
1	D	371/389 (95%)	351 (95%)	19 (5%)	1 (0%)	41	41
1	E	371/389 (95%)	351 (95%)	19 (5%)	1 (0%)	41	41
1	F	371/389 (95%)	353 (95%)	16 (4%)	2 (0%)	29	26
All	All	2229/2334 (96%)	2101 (94%)	120 (5%)	8 (0%)	34	32

All (8) Ramachandran outliers are listed below:

Mol	Chain	Res	Type
1	C	10	ILE
1	B	269	GLY
1	A	269	GLY
1	C	269	GLY
1	E	269	GLY
1	F	269	GLY
1	D	269	GLY
1	F	74	HIS

### 5.3.2 Protein sidechains [i](#)

In the following table, the Percentiles column shows the percent sidechain outliers of the chain as a percentile score with respect to all X-ray entries followed by that with respect to entries of similar resolution.

The Analysed column shows the number of residues for which the sidechain conformation was analysed, and the total number of residues.

*Continued on next page...*

*Continued from previous page...*

Mol	Chain	Analysed	Rotameric	Outliers	Percentiles	
1	A	312/326 (96%)	301 (96%)	11 (4%)	36	38
1	B	312/326 (96%)	296 (95%)	16 (5%)	24	22
1	C	312/326 (96%)	296 (95%)	16 (5%)	24	22
1	D	311/326 (95%)	300 (96%)	11 (4%)	36	38
1	E	311/326 (95%)	299 (96%)	12 (4%)	32	33
1	F	311/326 (95%)	300 (96%)	11 (4%)	36	38
All	All	1869/1956 (96%)	1792 (96%)	77 (4%)	30	31

All (77) residues with a non-rotameric sidechain are listed below:

Mol	Chain	Res	Type
1	A	18	TRP
1	A	36	ARG
1	A	57	LEU
1	A	95	TYR
1	A	111	LEU
1	A	124	LEU
1	A	161	LEU
1	A	298	LEU
1	A	325	LEU
1	A	336	LEU
1	A	357	PHE
1	B	18	TRP
1	B	36	ARG
1	B	57	LEU
1	B	95	TYR
1	B	106	LYS
1	B	111	LEU
1	B	121	ARG
1	B	124	LEU
1	B	161	LEU
1	B	232	LEU
1	B	298	LEU
1	B	325	LEU
1	B	336	LEU
1	B	349	ARG
1	B	357	PHE
1	B	381	ASP

*Continued on next page...*

*Continued from previous page...*

<b>Mol</b>	<b>Chain</b>	<b>Res</b>	<b>Type</b>
1	C	10	ILE
1	C	18	TRP
1	C	23	ASP
1	C	36	ARG
1	C	57	LEU
1	C	95	TYR
1	C	111	LEU
1	C	124	LEU
1	C	144	GLU
1	C	161	LEU
1	C	201	ILE
1	C	232	LEU
1	C	298	LEU
1	C	325	LEU
1	C	336	LEU
1	C	357	PHE
1	D	18	TRP
1	D	57	LEU
1	D	95	TYR
1	D	111	LEU
1	D	124	LEU
1	D	161	LEU
1	D	232	LEU
1	D	298	LEU
1	D	325	LEU
1	D	336	LEU
1	D	357	PHE
1	E	18	TRP
1	E	23	ASP
1	E	57	LEU
1	E	95	TYR
1	E	111	LEU
1	E	124	LEU
1	E	161	LEU
1	E	232	LEU
1	E	298	LEU
1	E	325	LEU
1	E	336	LEU
1	E	357	PHE
1	F	18	TRP
1	F	57	LEU
1	F	95	TYR

*Continued on next page...*

*Continued from previous page...*

Mol	Chain	Res	Type
1	F	124	LEU
1	F	161	LEU
1	F	232	LEU
1	F	296	LEU
1	F	298	LEU
1	F	325	LEU
1	F	336	LEU
1	F	357	PHE

Sometimes sidechains can be flipped to improve hydrogen bonding and reduce clashes. All (13) such sidechains are listed below:

Mol	Chain	Res	Type
1	A	214	GLN
1	B	235	HIS
1	B	372	GLN
1	C	235	HIS
1	C	253	HIS
1	C	372	GLN
1	D	143	GLN
1	E	118	GLN
1	E	164	HIS
1	E	199	ASN
1	E	247	GLN
1	F	214	GLN
1	F	372	GLN

### 5.3.3 RNA [i](#)

There are no RNA molecules in this entry.

### 5.4 Non-standard residues in protein, DNA, RNA chains [i](#)

There are no non-standard protein/DNA/RNA residues in this entry.

### 5.5 Carbohydrates [i](#)

There are no monosaccharides in this entry.

## 5.6 Ligand geometry

Of 18 ligands modelled in this entry, 12 are monoatomic - leaving 6 for Mogul analysis.

In the following table, the Counts columns list the number of bonds (or angles) for which Mogul statistics could be retrieved, the number of bonds (or angles) that are observed in the model and the number of bonds (or angles) that are defined in the Chemical Component Dictionary. The Link column lists molecule types, if any, to which the group is linked. The Z score for a bond length (or angle) is the number of standard deviations the observed value is removed from the expected value. A bond length (or angle) with  $|Z| > 2$  is considered an outlier worth inspection. RMSZ is the root-mean-square of all Z scores of the bond lengths (or angles).

Mol	Type	Chain	Res	Link	Bond lengths			Bond angles		
					Counts	RMSZ	$\# Z  > 2$	Counts	RMSZ	$\# Z  > 2$
3	FES	E	502	1	0,4,4	-	-	-		
3	FES	F	502	1	0,4,4	-	-	-		
3	FES	A	502	1	0,4,4	-	-	-		
3	FES	C	502	1	0,4,4	-	-	-		
3	FES	B	502	1	0,4,4	-	-	-		
3	FES	D	502	1	0,4,4	-	-	-		

In the following table, the Chirals column lists the number of chiral outliers, the number of chiral centers analysed, the number of these observed in the model and the number defined in the Chemical Component Dictionary. Similar counts are reported in the Torsion and Rings columns. '-' means no outliers of that kind were identified.

Mol	Type	Chain	Res	Link	Chirals	Torsions	Rings
3	FES	E	502	1	-	-	0/1/1/1
3	FES	F	502	1	-	-	0/1/1/1
3	FES	A	502	1	-	-	0/1/1/1
3	FES	C	502	1	-	-	0/1/1/1
3	FES	B	502	1	-	-	0/1/1/1
3	FES	D	502	1	-	-	0/1/1/1

There are no bond length outliers.

There are no bond angle outliers.

There are no chirality outliers.

There are no torsion outliers.

There are no ring outliers.

6 monomers are involved in 6 short contacts:

Mol	Chain	Res	Type	Clashes	Symm-Clashes
3	E	502	FES	1	0

*Continued on next page...*



*Continued from previous page...*

Mol	Chain	Res	Type	Clashes	Symm-Clashes
3	F	502	FES	1	0
3	A	502	FES	1	0
3	C	502	FES	1	0
3	B	502	FES	1	0
3	D	502	FES	1	0

## 5.7 Other polymers [i](#)

There are no such residues in this entry.

## 5.8 Polymer linkage issues [i](#)

There are no chain breaks in this entry.

## 6 Fit of model and data

### 6.1 Protein, DNA and RNA chains

In the following table, the column labelled ‘#RSRZ> 2’ contains the number (and percentage) of RSRZ outliers, followed by percent RSRZ outliers for the chain as percentile scores relative to all X-ray entries and entries of similar resolution. The OWAB column contains the minimum, median, 95<sup>th</sup> percentile and maximum values of the occupancy-weighted average B-factor per residue. The column labelled ‘Q< 0.9’ lists the number of (and percentage) of residues with an average occupancy less than 0.9.

Mol	Chain	Analysed	<RSRZ>	#RSRZ>2	OWAB(Å <sup>2</sup> )	Q<0.9
1	A	374/389 (96%)	0.09	30 (8%) 12 16	23, 35, 50, 61	0
1	B	374/389 (96%)	-0.11	15 (4%) 38 44	21, 32, 47, 61	0
1	C	374/389 (96%)	-0.05	14 (3%) 41 48	21, 33, 48, 60	0
1	D	373/389 (95%)	-0.20	7 (1%) 66 71	21, 32, 46, 57	0
1	E	373/389 (95%)	-0.05	20 (5%) 25 31	22, 34, 50, 58	0
1	F	373/389 (95%)	-0.13	15 (4%) 38 44	22, 33, 47, 56	0
All	All	2241/2334 (96%)	-0.08	101 (4%) 33 38	21, 33, 49, 61	0

All (101) RSRZ outliers are listed below:

Mol	Chain	Res	Type	RSRZ
1	E	8	ALA	6.6
1	C	8	ALA	6.3
1	D	8	ALA	5.8
1	B	381	ASP	5.6
1	A	211	ASP	5.1
1	C	381	ASP	5.1
1	D	10	ILE	5.0
1	C	306	GLY	5.0
1	E	306	GLY	4.9
1	B	10	ILE	4.7
1	E	211	ASP	4.7
1	C	312	ARG	4.7
1	A	381	ASP	4.6
1	F	8	ALA	4.6
1	E	10	ILE	4.6
1	A	236	SER	4.5
1	C	10	ILE	4.3
1	A	306	GLY	4.3
1	B	8	ALA	4.3

*Continued on next page...*

*Continued from previous page...*

<b>Mol</b>	<b>Chain</b>	<b>Res</b>	<b>Type</b>	<b>RSRZ</b>
1	C	9	GLY	4.2
1	A	308	GLU	4.1
1	A	237	VAL	3.9
1	E	309	GLU	3.9
1	A	233	GLY	3.9
1	C	308	GLU	3.7
1	E	308	GLU	3.7
1	E	312	ARG	3.7
1	F	10	ILE	3.6
1	A	222	GLU	3.6
1	B	380	ARG	3.5
1	F	9	GLY	3.5
1	B	221	GLY	3.5
1	B	309	GLU	3.4
1	A	307	SER	3.4
1	B	306	GLY	3.4
1	A	213	GLU	3.3
1	A	231	LEU	3.3
1	F	306	GLY	3.2
1	E	349	ARG	3.2
1	A	312	ARG	3.2
1	E	311	ALA	3.2
1	A	10	ILE	3.2
1	C	309	GLU	3.1
1	A	232	LEU	3.1
1	A	309	GLU	3.1
1	A	210	GLY	3.1
1	E	305	VAL	3.1
1	A	215	LEU	3.1
1	A	8	ALA	3.1
1	B	211	ASP	3.1
1	F	380	ARG	3.1
1	A	304	ARG	3.0
1	D	9	GLY	3.0
1	E	9	GLY	2.9
1	F	312	ARG	2.9
1	B	305	VAL	2.9
1	F	234	GLU	2.8
1	A	305	VAL	2.8
1	B	9	GLY	2.8
1	A	9	GLY	2.8
1	D	211	ASP	2.8

*Continued on next page...*

*Continued from previous page...*

<b>Mol</b>	<b>Chain</b>	<b>Res</b>	<b>Type</b>	<b>RSRZ</b>
1	D	312	ARG	2.8
1	A	212	PRO	2.8
1	A	234	GLU	2.7
1	F	308	GLU	2.7
1	F	307	SER	2.7
1	A	220	THR	2.7
1	D	308	GLU	2.6
1	E	213	GLU	2.6
1	C	211	ASP	2.6
1	C	307	SER	2.6
1	F	349	ARG	2.6
1	A	208	ALA	2.6
1	A	380	ARG	2.5
1	E	380	ARG	2.5
1	F	305	VAL	2.5
1	E	307	SER	2.5
1	B	304	ARG	2.4
1	F	309	GLU	2.4
1	B	308	GLU	2.4
1	A	349	ARG	2.4
1	E	214	GLN	2.4
1	A	207	PHE	2.3
1	B	312	ARG	2.3
1	D	349	ARG	2.3
1	C	310	GLU	2.3
1	E	320	GLU	2.3
1	B	307	SER	2.3
1	F	211	ASP	2.3
1	C	380	ARG	2.3
1	E	304	ARG	2.3
1	E	310	GLU	2.2
1	A	352	ARG	2.1
1	B	117	VAL	2.1
1	E	212	PRO	2.1
1	E	352	ARG	2.1
1	F	304	ARG	2.0
1	F	11	ALA	2.0
1	A	310	GLU	2.0
1	C	352	ARG	2.0
1	C	305	VAL	2.0

## 6.2 Non-standard residues in protein, DNA, RNA chains [i](#)

There are no non-standard protein/DNA/RNA residues in this entry.

## 6.3 Carbohydrates [i](#)

There are no monosaccharides in this entry.

## 6.4 Ligands [i](#)

In the following table, the Atoms column lists the number of modelled atoms in the group and the number defined in the chemical component dictionary. The B-factors column lists the minimum, median, 95<sup>th</sup> percentile and maximum values of B factors of atoms in the group. The column labelled 'Q< 0.9' lists the number of atoms with occupancy less than 0.9.

Mol	Type	Chain	Res	Atoms	RSCC	RSR	B-factors(Å <sup>2</sup> )	Q<0.9
2	FE2	D	503	1/1	0.94	0.23	35,35,35,35	0
2	FE2	E	503	1/1	0.94	0.23	36,36,36,36	0
2	FE2	B	503	1/1	0.95	0.23	35,35,35,35	0
2	FE2	C	503	1/1	0.97	0.23	34,34,34,34	0
2	FE2	A	503	1/1	0.98	0.24	35,35,35,35	0
2	FE2	F	503	1/1	0.98	0.26	36,36,36,36	0
2	FE2	C	501	1/1	0.99	0.28	16,16,16,16	0
2	FE2	E	501	1/1	0.99	0.25	15,15,15,15	0
2	FE2	A	501	1/1	0.99	0.22	16,16,16,16	0
2	FE2	F	501	1/1	0.99	0.25	10,10,10,10	0
2	FE2	D	501	1/1	0.99	0.26	11,11,11,11	0
3	FES	F	502	4/4	0.99	0.11	26,27,27,30	0
3	FES	A	502	4/4	1.00	0.10	26,26,27,32	0
3	FES	B	502	4/4	1.00	0.10	26,26,27,29	0
3	FES	C	502	4/4	1.00	0.11	23,23,24,28	0
3	FES	D	502	4/4	1.00	0.11	25,26,28,29	0
3	FES	E	502	4/4	1.00	0.11	23,24,26,28	0
2	FE2	B	501	1/1	1.00	0.27	11,11,11,11	0

## 6.5 Other polymers [i](#)

There are no such residues in this entry.