



Full wwPDB X-ray Structure Validation Report ⓘ

Jun 12, 2024 – 11:50 AM EDT

PDB ID : 2P76
Title : Crystal structure of a Glycerophosphodiester Phosphodiesterase from Staphylococcus aureus
Authors : Fedorov, A.A.; Fedorov, E.V.; Sauder, J.M.; Burley, S.K.; Almo, S.C.; New York SGX Research Center for Structural Genomics (NYSGXRC)
Deposited on : 2007-03-20
Resolution : 2.60 Å(reported)

This is a Full wwPDB X-ray Structure Validation Report for a publicly released PDB entry.

We welcome your comments at validation@mail.wwpdb.org

A user guide is available at

<https://www.wwpdb.org/validation/2017/XrayValidationReportHelp>

with specific help available everywhere you see the ⓘ symbol.

The types of validation reports are described at

<http://www.wwpdb.org/validation/2017/FAQs#types>.

The following versions of software and data (see [references ⓘ](#)) were used in the production of this report:

MolProbity : 4.02b-467
Mogul : 2022.3.0, CSD as543be (2022)
Xtriage (Phenix) : 1.20.1
EDS : 2.36.2
Percentile statistics : 20191225.v01 (using entries in the PDB archive December 25th 2019)
Refmac : 5.8.0158
CCP4 : 7.0.044 (Gargrove)
Ideal geometry (proteins) : Engh & Huber (2001)
Ideal geometry (DNA, RNA) : Parkinson et al. (1996)
Validation Pipeline (wwPDB-VP) : 2.36.2

1 Overall quality at a glance

The following experimental techniques were used to determine the structure:

X-RAY DIFFRACTION

The reported resolution of this entry is 2.60 Å.

Percentile scores (ranging between 0-100) for global validation metrics of the entry are shown in the following graphic. The table shows the number of entries on which the scores are based.

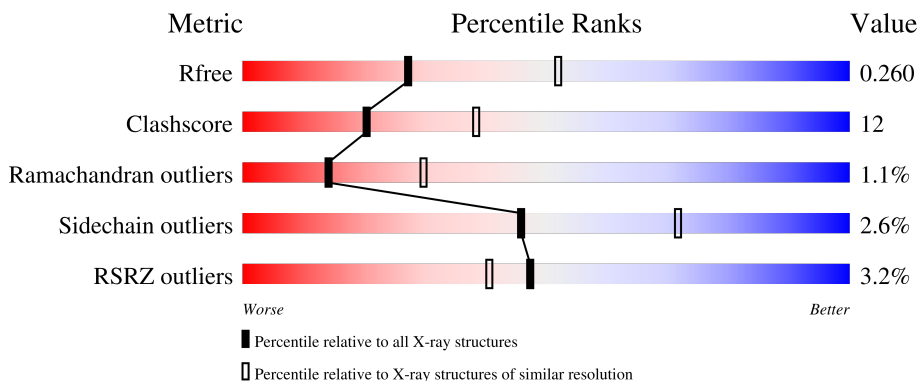



Metric	Whole archive (#Entries)	Similar resolution (#Entries, resolution range(Å))
R_{free}	130704	3163 (2.60-2.60)
Clashscore	141614	3518 (2.60-2.60)
Ramachandran outliers	138981	3455 (2.60-2.60)
Sidechain outliers	138945	3455 (2.60-2.60)
RSRZ outliers	127900	3104 (2.60-2.60)

The table below summarises the geometric issues observed across the polymeric chains and their fit to the electron density. The red, orange, yellow and green segments of the lower bar indicate the fraction of residues that contain outliers for ≥ 3 , 2, 1 and 0 types of geometric quality criteria respectively. A grey segment represents the fraction of residues that are not modelled. The numeric value for each fraction is indicated below the corresponding segment, with a dot representing fractions $\leq 5\%$. The upper red bar (where present) indicates the fraction of residues that have poor fit to the electron density. The numeric value is given above the bar.

Mol	Chain	Length	Quality of chain
1	A	287	 4% 66% 26% • 7%
1	B	287	 2% 63% 29% • 7%
1	C	287	 3% 67% 25% • 7%
1	D	287	 2% 66% 25% • 7%
1	E	287	 3% 65% 26% • 7%

Continued on next page...

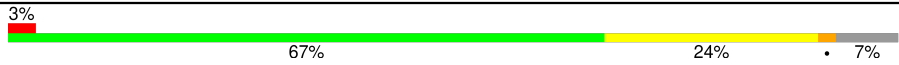
Continued from previous page...

Mol	Chain	Length	Quality of chain
1	F	287	
1	G	287	
1	H	287	

2 Entry composition i

There are 4 unique types of molecules in this entry. The entry contains 17578 atoms, of which 0 are hydrogens and 0 are deuteriums.

In the tables below, the ZeroOcc column contains the number of atoms modelled with zero occupancy, the AltConf column contains the number of residues with at least one atom in alternate conformation and the Trace column contains the number of residues modelled with at most 2 atoms.

- Molecule 1 is a protein called Glycerophosphoryl diester phosphodiesterase.

Mol	Chain	Residues	Atoms					ZeroOcc	AltConf	Trace
			Total	C	N	O	S			
1	A	267	2186	1381	386	415	4	0	0	0
1	B	267	2186	1381	386	415	4	0	0	0
1	C	267	2186	1381	386	415	4	0	0	0
1	D	267	2186	1381	386	415	4	0	0	0
1	E	267	2186	1381	386	415	4	0	0	0
1	F	267	2186	1381	386	415	4	0	0	0
1	G	267	2186	1381	386	415	4	0	0	0
1	H	267	2186	1381	386	415	4	0	0	0

There are 64 discrepancies between the modelled and reference sequences:

Chain	Residue	Modelled	Actual	Comment	Reference
A	310	GLU	-	cloning artifact	UNP Q7A6H7
A	311	GLY	-	cloning artifact	UNP Q7A6H7
A	312	HIS	-	cloning artifact	UNP Q7A6H7
A	313	HIS	-	cloning artifact	UNP Q7A6H7
A	314	HIS	-	cloning artifact	UNP Q7A6H7
A	315	HIS	-	cloning artifact	UNP Q7A6H7
A	316	HIS	-	cloning artifact	UNP Q7A6H7
A	317	HIS	-	cloning artifact	UNP Q7A6H7
B	310	GLU	-	cloning artifact	UNP Q7A6H7
B	311	GLY	-	cloning artifact	UNP Q7A6H7
B	312	HIS	-	cloning artifact	UNP Q7A6H7
B	313	HIS	-	cloning artifact	UNP Q7A6H7
B	314	HIS	-	cloning artifact	UNP Q7A6H7

Continued on next page...

Continued from previous page...

Chain	Residue	Modelled	Actual	Comment	Reference
B	315	HIS	-	cloning artifact	UNP Q7A6H7
B	316	HIS	-	cloning artifact	UNP Q7A6H7
B	317	HIS	-	cloning artifact	UNP Q7A6H7
C	310	GLU	-	cloning artifact	UNP Q7A6H7
C	311	GLY	-	cloning artifact	UNP Q7A6H7
C	312	HIS	-	cloning artifact	UNP Q7A6H7
C	313	HIS	-	cloning artifact	UNP Q7A6H7
C	314	HIS	-	cloning artifact	UNP Q7A6H7
C	315	HIS	-	cloning artifact	UNP Q7A6H7
C	316	HIS	-	cloning artifact	UNP Q7A6H7
C	317	HIS	-	cloning artifact	UNP Q7A6H7
D	310	GLU	-	cloning artifact	UNP Q7A6H7
D	311	GLY	-	cloning artifact	UNP Q7A6H7
D	312	HIS	-	cloning artifact	UNP Q7A6H7
D	313	HIS	-	cloning artifact	UNP Q7A6H7
D	314	HIS	-	cloning artifact	UNP Q7A6H7
D	315	HIS	-	cloning artifact	UNP Q7A6H7
D	316	HIS	-	cloning artifact	UNP Q7A6H7
D	317	HIS	-	cloning artifact	UNP Q7A6H7
E	310	GLU	-	cloning artifact	UNP Q7A6H7
E	311	GLY	-	cloning artifact	UNP Q7A6H7
E	312	HIS	-	cloning artifact	UNP Q7A6H7
E	313	HIS	-	cloning artifact	UNP Q7A6H7
E	314	HIS	-	cloning artifact	UNP Q7A6H7
E	315	HIS	-	cloning artifact	UNP Q7A6H7
E	316	HIS	-	cloning artifact	UNP Q7A6H7
E	317	HIS	-	cloning artifact	UNP Q7A6H7
F	310	GLU	-	cloning artifact	UNP Q7A6H7
F	311	GLY	-	cloning artifact	UNP Q7A6H7
F	312	HIS	-	cloning artifact	UNP Q7A6H7
F	313	HIS	-	cloning artifact	UNP Q7A6H7
F	314	HIS	-	cloning artifact	UNP Q7A6H7
F	315	HIS	-	cloning artifact	UNP Q7A6H7
F	316	HIS	-	cloning artifact	UNP Q7A6H7
F	317	HIS	-	cloning artifact	UNP Q7A6H7
G	310	GLU	-	cloning artifact	UNP Q7A6H7
G	311	GLY	-	cloning artifact	UNP Q7A6H7
G	312	HIS	-	cloning artifact	UNP Q7A6H7
G	313	HIS	-	cloning artifact	UNP Q7A6H7
G	314	HIS	-	cloning artifact	UNP Q7A6H7
G	315	HIS	-	cloning artifact	UNP Q7A6H7
G	316	HIS	-	cloning artifact	UNP Q7A6H7

Continued on next page...

Continued from previous page...

Chain	Residue	Modelled	Actual	Comment	Reference
G	317	HIS	-	cloning artifact	UNP Q7A6H7
H	310	GLU	-	cloning artifact	UNP Q7A6H7
H	311	GLY	-	cloning artifact	UNP Q7A6H7
H	312	HIS	-	cloning artifact	UNP Q7A6H7
H	313	HIS	-	cloning artifact	UNP Q7A6H7
H	314	HIS	-	cloning artifact	UNP Q7A6H7
H	315	HIS	-	cloning artifact	UNP Q7A6H7
H	316	HIS	-	cloning artifact	UNP Q7A6H7
H	317	HIS	-	cloning artifact	UNP Q7A6H7

- Molecule 2 is SODIUM ION (three-letter code: NA) (formula: Na).

Mol	Chain	Residues	Atoms	ZeroOcc	AltConf
2	A	1	Total Na 1 1	0	0
2	B	1	Total Na 1 1	0	0
2	C	1	Total Na 1 1	0	0
2	D	1	Total Na 1 1	0	0
2	E	1	Total Na 1 1	0	0
2	F	1	Total Na 1 1	0	0
2	G	1	Total Na 1 1	0	0
2	H	1	Total Na 1 1	0	0

- Molecule 3 is GLYCEROL (three-letter code: GOL) (formula: C₃H₈O₃).



Mol	Chain	Residues	Atoms	ZeroOcc	AltConf
3	A	1	Total C O 6 3 3	0	0
3	B	1	Total C O 6 3 3	0	0
3	C	1	Total C O 6 3 3	0	0
3	D	1	Total C O 6 3 3	0	0
3	E	1	Total C O 6 3 3	0	0
3	F	1	Total C O 6 3 3	0	0
3	G	1	Total C O 6 3 3	0	0
3	H	1	Total C O 6 3 3	0	0

- Molecule 4 is water.

Mol	Chain	Residues	Atoms	ZeroOcc	AltConf
4	A	8	Total O 8 8	0	0
4	B	5	Total O 5 5	0	0
4	C	8	Total O 8 8	0	0
4	D	10	Total O 10 10	0	0

Continued on next page...

Continued from previous page...

Mol	Chain	Residues	Atoms	ZeroOcc	AltConf
4	E	1	Total O 1 1	0	0
4	G	1	Total O 1 1	0	0
4	H	1	Total O 1 1	0	0

3 Residue-property plots [i](#)

These plots are drawn for all protein, RNA, DNA and oligosaccharide chains in the entry. The first graphic for a chain summarises the proportions of the various outlier classes displayed in the second graphic. The second graphic shows the sequence view annotated by issues in geometry and electron density. Residues are color-coded according to the number of geometric quality criteria for which they contain at least one outlier: green = 0, yellow = 1, orange = 2 and red = 3 or more. A red dot above a residue indicates a poor fit to the electron density ($RSRZ > 2$). Stretches of 2 or more consecutive residues without any outlier are shown as a green connector. Residues present in the sample, but not in the model, are shown in grey.

- Molecule 1: Glycerophosphoryl diester phosphodiesterase

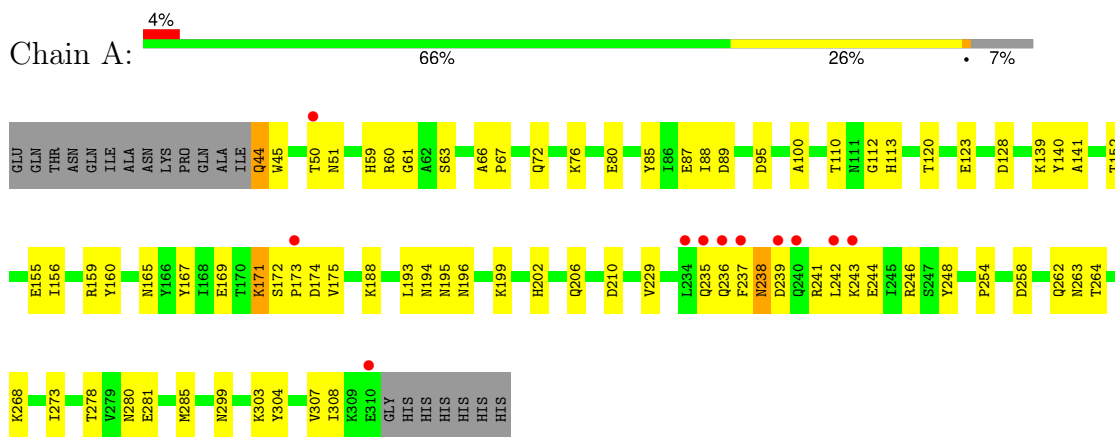

- Molecule 1: Glycerophosphoryl diester phosphodiesterase

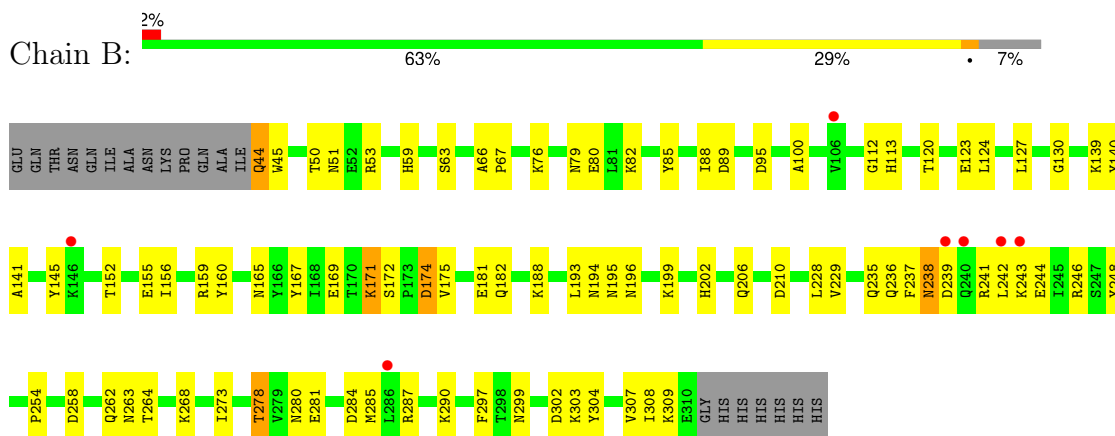

- Molecule 1: Glycerophosphoryl diester phosphodiesterase

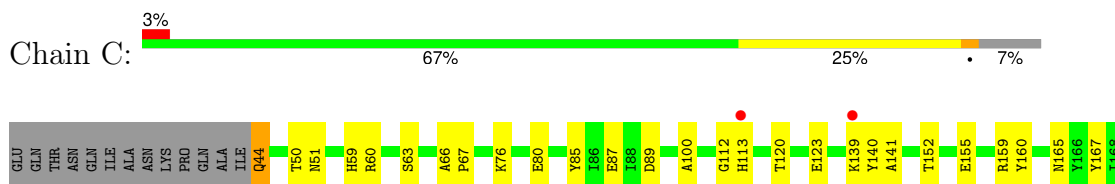

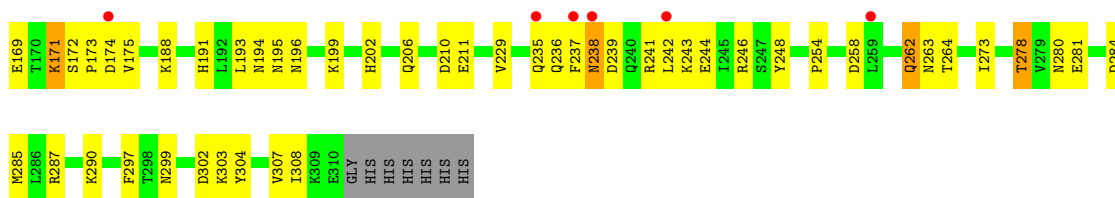

- Molecule 1: Glycerophosphoryl diester phosphodiesterase

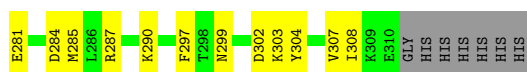
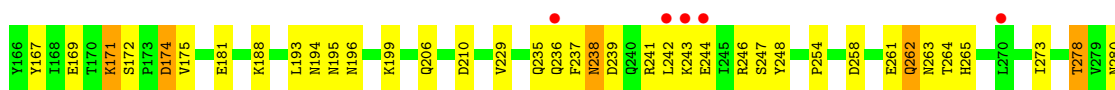

- Molecule 1: Glycerophosphoryl diester phosphodiesterase



- Molecule 1: Glycerophosphoryl diester phosphodiesterase



- Molecule 1: Glycerophosphoryl diester phosphodiesterase

Chain G:  3% 65% 26% 7%

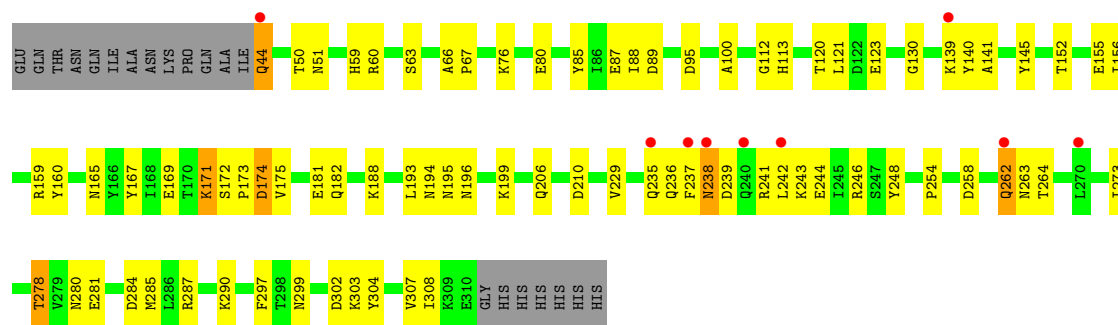

• Molecule 1: Glycerophosphoryl diester phosphodiesterase

Chain H:  4% 66% 25% 7%

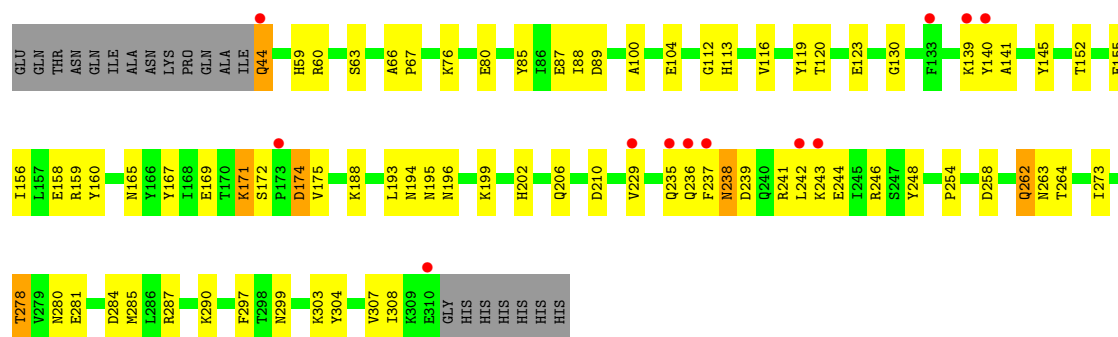

4 Data and refinement statistics i

Property	Value	Source
Space group	P 31 2 1	Depositor
Cell constants a, b, c, α , β , γ	115.16Å 115.16Å 451.33Å 90.00° 90.00° 120.00°	Depositor
Resolution (Å)	24.97 – 2.60 39.45 – 2.60	Depositor EDS
% Data completeness (in resolution range)	91.0 (24.97-2.60) 91.0 (39.45-2.60)	Depositor EDS
R_{merge}	0.05	Depositor
R_{sym}	(Not available)	Depositor
$\langle I/\sigma(I) \rangle$ ¹	1.44 (at 2.61Å)	Xtrriage
Refinement program	CNS 1.1	Depositor
R, R_{free}	0.249 , 0.265 0.244 , 0.260	Depositor DCC
R_{free} test set	5444 reflections (5.03%)	wwPDB-VP
Wilson B-factor (Å ²)	55.0	Xtrriage
Anisotropy	0.173	Xtrriage
Bulk solvent k_{sol} (e/Å ³), B_{sol} (Å ²)	0.35 , 39.5	EDS
L-test for twinning ²	$\langle L \rangle = 0.47$, $\langle L^2 \rangle = 0.30$	Xtrriage
Estimated twinning fraction	0.066 for -h,-k,l	Xtrriage
F_o, F_c correlation	0.93	EDS
Total number of atoms	17578	wwPDB-VP
Average B, all atoms (Å ²)	59.0	wwPDB-VP

Xtrriage's analysis on translational NCS is as follows: *The analyses of the Patterson function reveals a significant off-origin peak that is 32.20 % of the origin peak, indicating pseudo-translational symmetry. The chance of finding a peak of this or larger height randomly in a structure without pseudo-translational symmetry is equal to 9.7742e-04. The detected translational NCS is most likely also responsible for the elevated intensity ratio.*

¹Intensities estimated from amplitudes.

²Theoretical values of $\langle |L| \rangle$, $\langle L^2 \rangle$ for acentric reflections are 0.5, 0.333 respectively for untwinned datasets, and 0.375, 0.2 for perfectly twinned datasets.

5 Model quality

5.1 Standard geometry

Bond lengths and bond angles in the following residue types are not validated in this section: GOL, NA

The Z score for a bond length (or angle) is the number of standard deviations the observed value is removed from the expected value. A bond length (or angle) with $|Z| > 5$ is considered an outlier worth inspection. RMSZ is the root-mean-square of all Z scores of the bond lengths (or angles).

Mol	Chain	Bond lengths		Bond angles	
		RMSZ	# Z >5	RMSZ	# Z >5
1	A	0.40	0/2237	0.67	1/3021 (0.0%)
1	B	0.40	0/2237	0.67	1/3021 (0.0%)
1	C	0.39	0/2237	0.67	1/3021 (0.0%)
1	D	0.40	0/2237	0.67	1/3021 (0.0%)
1	E	0.38	0/2237	0.67	1/3021 (0.0%)
1	F	0.40	0/2237	0.66	1/3021 (0.0%)
1	G	0.40	0/2237	0.67	1/3021 (0.0%)
1	H	0.39	0/2237	0.66	1/3021 (0.0%)
All	All	0.40	0/17896	0.67	8/24168 (0.0%)

There are no bond length outliers.

All (8) bond angle outliers are listed below:

Mol	Chain	Res	Type	Atoms	Z	Observed(°)	Ideal(°)
1	F	273	ILE	N-CA-C	-5.43	96.33	111.00
1	C	273	ILE	N-CA-C	-5.34	96.58	111.00
1	G	273	ILE	N-CA-C	-5.34	96.59	111.00
1	A	273	ILE	N-CA-C	-5.31	96.65	111.00
1	H	273	ILE	N-CA-C	-5.31	96.66	111.00
1	B	273	ILE	N-CA-C	-5.31	96.67	111.00
1	E	273	ILE	N-CA-C	-5.29	96.71	111.00
1	D	273	ILE	N-CA-C	-5.25	96.83	111.00

There are no chirality outliers.

There are no planarity outliers.

5.2 Too-close contacts

In the following table, the Non-H and H(model) columns list the number of non-hydrogen atoms and hydrogen atoms in the chain respectively. The H(added) column lists the number of hydrogen atoms added and optimized by MolProbity. The Clashes column lists the number of clashes within the asymmetric unit, whereas Symm-Clashes lists symmetry-related clashes.

Mol	Chain	Non-H	H(model)	H(added)	Clashes	Symm-Clashes
1	A	2186	0	2135	48	0
1	B	2186	0	2135	65	0
1	C	2186	0	2135	57	0
1	D	2186	0	2135	57	0
1	E	2186	0	2135	55	0
1	F	2186	0	2135	52	0
1	G	2186	0	2135	56	0
1	H	2186	0	2135	57	0
2	A	1	0	0	0	0
2	B	1	0	0	0	0
2	C	1	0	0	0	0
2	D	1	0	0	0	0
2	E	1	0	0	0	0
2	F	1	0	0	0	0
2	G	1	0	0	0	0
2	H	1	0	0	0	0
3	A	6	0	8	0	0
3	B	6	0	8	1	0
3	C	6	0	8	0	0
3	D	6	0	8	0	0
3	E	6	0	8	1	0
3	F	6	0	8	0	0
3	G	6	0	8	0	0
3	H	6	0	8	1	0
4	A	8	0	0	0	0
4	B	5	0	0	0	0
4	C	8	0	0	1	0
4	D	10	0	0	0	0
4	E	1	0	0	0	0
4	G	1	0	0	0	0
4	H	1	0	0	0	0
All	All	17578	0	17144	430	0

The all-atom clashscore is defined as the number of clashes found per 1000 atoms (including hydrogen atoms). The all-atom clashscore for this structure is 12.

All (430) close contacts within the same asymmetric unit are listed below, sorted by their clash magnitude.

Atom-1	Atom-2	Interatomic distance (Å)	Clash overlap (Å)
1:D:235:GLN:HE22	1:D:258:ASP:HB3	1.45	0.81
1:F:235:GLN:HE22	1:F:258:ASP:HB3	1.47	0.80
1:E:235:GLN:HE22	1:E:258:ASP:HB3	1.47	0.80
1:H:235:GLN:HE22	1:H:258:ASP:HB3	1.48	0.79
1:F:241:ARG:O	1:F:244:GLU:HG2	1.84	0.78
1:G:235:GLN:HE22	1:G:258:ASP:HB3	1.48	0.78
1:E:241:ARG:O	1:E:244:GLU:HG2	1.84	0.78
1:A:241:ARG:O	1:A:244:GLU:HG2	1.82	0.78
1:B:241:ARG:O	1:B:244:GLU:HG2	1.83	0.78
1:A:235:GLN:HE22	1:A:258:ASP:HB3	1.46	0.78
1:D:241:ARG:O	1:D:244:GLU:HG2	1.84	0.78
1:C:235:GLN:HE22	1:C:258:ASP:HB3	1.48	0.77
1:H:241:ARG:O	1:H:244:GLU:HG2	1.85	0.77
1:B:235:GLN:HE22	1:B:258:ASP:HB3	1.49	0.76
1:D:171:LYS:HB3	1:D:175:VAL:HG11	1.68	0.76
1:G:241:ARG:O	1:G:244:GLU:HG2	1.84	0.76
1:A:171:LYS:HB3	1:A:175:VAL:HG11	1.68	0.76
1:C:241:ARG:O	1:C:244:GLU:HG2	1.84	0.76
1:H:171:LYS:HB3	1:H:175:VAL:HG11	1.67	0.76
1:B:188:LYS:HB2	1:B:193:LEU:HD12	1.68	0.75
1:E:171:LYS:HB3	1:E:175:VAL:HG11	1.68	0.75
1:H:188:LYS:HB2	1:H:193:LEU:HD12	1.67	0.74
1:B:171:LYS:HB3	1:B:175:VAL:HG11	1.68	0.74
1:F:171:LYS:HB3	1:F:175:VAL:HG11	1.69	0.74
1:C:171:LYS:HB3	1:C:175:VAL:HG11	1.66	0.74
1:E:188:LYS:HB2	1:E:193:LEU:HD12	1.68	0.74
1:G:171:LYS:HB3	1:G:175:VAL:HG11	1.68	0.74
1:C:172:SER:O	1:C:175:VAL:HG12	1.88	0.73
1:D:188:LYS:HB2	1:D:193:LEU:HD12	1.71	0.73
1:F:172:SER:O	1:F:175:VAL:HG12	1.88	0.73
1:A:188:LYS:HB2	1:A:193:LEU:HD12	1.71	0.73
1:H:172:SER:O	1:H:175:VAL:HG12	1.88	0.73
1:G:172:SER:O	1:G:175:VAL:HG12	1.88	0.73
1:G:188:LYS:HB2	1:G:193:LEU:HD12	1.70	0.73
1:C:188:LYS:HB2	1:C:193:LEU:HD12	1.71	0.72
1:A:172:SER:O	1:A:175:VAL:HG12	1.88	0.72
1:B:139:LYS:HE3	1:B:140:TYR:CZ	2.25	0.72
1:F:188:LYS:HB2	1:F:193:LEU:HD12	1.70	0.72
1:E:172:SER:O	1:E:175:VAL:HG12	1.89	0.72
1:B:172:SER:O	1:B:175:VAL:HG12	1.90	0.71
1:E:139:LYS:HE3	1:E:140:TYR:CZ	2.27	0.70
1:F:59:HIS:O	1:F:63:SER:HB2	1.92	0.70

Continued on next page...

Continued from previous page...

Atom-1	Atom-2	Interatomic distance (Å)	Clash overlap (Å)
1:C:191:HIS:CD2	1:D:138:PRO:HB2	2.25	0.70
1:A:59:HIS:O	1:A:63:SER:HB2	1.91	0.70
1:D:172:SER:O	1:D:175:VAL:HG12	1.91	0.70
1:F:139:LYS:HE3	1:F:140:TYR:CZ	2.27	0.70
1:G:59:HIS:O	1:G:63:SER:HB2	1.93	0.69
1:H:59:HIS:O	1:H:63:SER:HB2	1.91	0.69
1:H:237:PHE:HB2	1:H:241:ARG:HG2	1.74	0.69
1:B:237:PHE:HB2	1:B:241:ARG:HG2	1.75	0.69
1:C:59:HIS:O	1:C:63:SER:HB2	1.92	0.69
1:B:59:HIS:O	1:B:63:SER:HB2	1.93	0.68
1:E:59:HIS:O	1:E:63:SER:HB2	1.93	0.68
1:C:211:GLU:HB2	4:C:503:HOH:O	1.94	0.68
1:D:237:PHE:HB2	1:D:241:ARG:HG2	1.76	0.68
1:G:139:LYS:HE3	1:G:140:TYR:CZ	2.29	0.68
1:C:76:LYS:HE3	1:C:80:GLU:OE2	1.94	0.68
1:C:139:LYS:HE3	1:C:140:TYR:CZ	2.29	0.67
1:E:237:PHE:HB2	1:E:241:ARG:HG2	1.75	0.67
1:G:237:PHE:HB2	1:G:241:ARG:HG2	1.75	0.67
1:D:59:HIS:O	1:D:63:SER:HB2	1.95	0.67
1:A:139:LYS:HE3	1:A:140:TYR:CZ	2.29	0.67
1:A:237:PHE:HB2	1:A:241:ARG:HG2	1.77	0.67
1:A:76:LYS:HE3	1:A:80:GLU:OE2	1.95	0.67
1:H:76:LYS:HE3	1:H:80:GLU:OE2	1.95	0.67
1:E:239:ASP:O	1:E:243:LYS:HG2	1.95	0.66
1:B:76:LYS:HE3	1:B:80:GLU:OE2	1.95	0.66
1:D:139:LYS:HE3	1:D:140:TYR:CZ	2.30	0.66
1:H:139:LYS:HE3	1:H:140:TYR:CZ	2.30	0.65
1:E:76:LYS:HE3	1:E:80:GLU:OE2	1.96	0.65
1:D:76:LYS:HE3	1:D:80:GLU:OE2	1.96	0.65
1:F:237:PHE:HB2	1:F:241:ARG:HG2	1.77	0.65
1:B:120:THR:OG1	1:B:123:GLU:HG3	1.97	0.64
1:C:195:ASN:O	1:C:199:LYS:HG2	1.97	0.64
1:C:237:PHE:HB2	1:C:241:ARG:HG2	1.79	0.64
1:F:76:LYS:HE3	1:F:80:GLU:OE2	1.98	0.64
1:F:195:ASN:O	1:F:199:LYS:HG2	1.98	0.63
1:B:309:LYS:HD3	1:C:196:ASN:ND2	2.12	0.63
1:A:239:ASP:O	1:A:243:LYS:HG2	1.98	0.63
1:C:239:ASP:O	1:C:243:LYS:HG2	1.99	0.63
1:G:76:LYS:HE3	1:G:80:GLU:OE2	1.99	0.63
1:E:194:ASN:HD21	1:E:196:ASN:HB3	1.63	0.63
1:E:152:THR:OG1	1:E:155:GLU:HG3	1.99	0.62

Continued on next page...

Continued from previous page...

Atom-1	Atom-2	Interatomic distance (Å)	Clash overlap (Å)
1:D:195:ASN:O	1:D:199:LYS:HG2	1.99	0.62
1:F:152:THR:OG1	1:F:155:GLU:HG3	2.00	0.62
1:H:152:THR:OG1	1:H:155:GLU:HG3	1.98	0.62
1:E:195:ASN:O	1:E:199:LYS:HG2	1.98	0.62
1:B:195:ASN:O	1:B:199:LYS:HG2	2.00	0.62
1:F:194:ASN:HD21	1:F:196:ASN:HB3	1.65	0.62
1:H:239:ASP:O	1:H:243:LYS:HG2	2.00	0.61
1:B:152:THR:OG1	1:B:155:GLU:HG3	2.00	0.61
1:D:181:GLU:HB3	1:G:181:GLU:HB3	1.81	0.61
1:G:194:ASN:HD21	1:G:196:ASN:HB3	1.66	0.61
1:G:239:ASP:O	1:G:243:LYS:HG2	2.01	0.61
1:D:239:ASP:O	1:D:243:LYS:HG2	2.00	0.61
1:H:194:ASN:HD21	1:H:196:ASN:HB3	1.66	0.61
1:B:239:ASP:O	1:B:243:LYS:HG2	2.00	0.61
1:A:195:ASN:O	1:A:199:LYS:HG2	2.02	0.60
1:F:239:ASP:O	1:F:243:LYS:HG2	2.01	0.60
1:C:191:HIS:HD2	1:D:138:PRO:HB2	1.66	0.60
1:H:195:ASN:O	1:H:199:LYS:HG2	2.00	0.60
1:F:120:THR:OG1	1:F:123:GLU:HG3	2.01	0.60
1:G:195:ASN:O	1:G:199:LYS:HG2	2.02	0.60
1:H:159:ARG:HD3	1:H:160:TYR:CZ	2.37	0.59
1:G:159:ARG:HD3	1:G:160:TYR:CZ	2.38	0.59
1:A:194:ASN:HD21	1:A:196:ASN:HB3	1.66	0.59
1:G:120:THR:OG1	1:G:123:GLU:HG3	2.02	0.59
1:B:237:PHE:CB	1:B:241:ARG:HG2	2.33	0.58
1:B:159:ARG:HD3	1:B:160:TYR:CZ	2.39	0.58
1:G:85:TYR:CE1	1:G:165:ASN:HB3	2.38	0.58
1:G:152:THR:OG1	1:G:155:GLU:HG3	2.02	0.58
1:H:85:TYR:CE1	1:H:165:ASN:HB3	2.38	0.58
1:A:238:ASN:O	1:A:242:LEU:HG	2.04	0.58
1:H:237:PHE:CB	1:H:241:ARG:HG2	2.33	0.58
1:A:152:THR:OG1	1:A:155:GLU:HG3	2.04	0.58
1:B:194:ASN:HD21	1:B:196:ASN:HB3	1.69	0.58
1:F:85:TYR:CE1	1:F:165:ASN:HB3	2.39	0.57
1:H:120:THR:OG1	1:H:123:GLU:HG3	2.03	0.57
1:E:237:PHE:CB	1:E:241:ARG:HG2	2.34	0.57
1:E:238:ASN:O	1:E:242:LEU:HG	2.04	0.57
1:B:79:ASN:O	1:D:144:SER:HB3	2.04	0.57
1:B:182:GLN:HA	1:E:181:GLU:HG2	1.85	0.57
1:C:194:ASN:HD21	1:C:196:ASN:HB3	1.68	0.57
1:C:152:THR:OG1	1:C:155:GLU:HG3	2.04	0.57

Continued on next page...

Continued from previous page...

Atom-1	Atom-2	Interatomic distance (Å)	Clash overlap (Å)
1:D:199:LYS:HE3	1:F:309:LYS:HD3	1.86	0.57
1:F:238:ASN:O	1:F:242:LEU:HG	2.04	0.57
1:A:159:ARG:HD3	1:A:160:TYR:CZ	2.39	0.57
1:B:85:TYR:CE1	1:B:165:ASN:HB3	2.39	0.57
1:G:237:PHE:CB	1:G:241:ARG:HG2	2.35	0.57
1:G:238:ASN:O	1:G:242:LEU:HG	2.04	0.56
1:D:152:THR:OG1	1:D:155:GLU:HG3	2.04	0.56
1:E:159:ARG:HD3	1:E:160:TYR:CZ	2.40	0.56
1:H:238:ASN:O	1:H:242:LEU:HG	2.04	0.56
1:B:53:ARG:HB3	1:C:51:ASN:OD1	2.04	0.56
1:B:238:ASN:O	1:B:242:LEU:HG	2.06	0.56
1:D:194:ASN:HD21	1:D:196:ASN:HB3	1.69	0.56
1:F:159:ARG:HD3	1:F:160:TYR:CZ	2.41	0.56
1:D:237:PHE:CB	1:D:241:ARG:HG2	2.35	0.56
1:B:228:LEU:HD13	3:B:501:GOL:H12	1.88	0.55
1:F:237:PHE:CB	1:F:241:ARG:HG2	2.36	0.55
1:E:85:TYR:CE1	1:E:165:ASN:HB3	2.41	0.55
1:B:181:GLU:HG2	1:E:182:GLN:HG2	1.88	0.55
1:C:238:ASN:O	1:C:242:LEU:HG	2.06	0.54
1:B:237:PHE:CG	1:B:241:ARG:HG2	2.43	0.54
1:E:120:THR:OG1	1:E:123:GLU:HG3	2.07	0.54
1:B:82:LYS:HD2	1:D:143:ALA:HB3	1.88	0.54
1:C:85:TYR:CE1	1:C:165:ASN:HB3	2.42	0.54
1:A:237:PHE:CB	1:A:241:ARG:HG2	2.37	0.53
1:C:237:PHE:CB	1:C:241:ARG:HG2	2.38	0.53
1:D:238:ASN:O	1:D:242:LEU:HG	2.07	0.53
1:A:85:TYR:CE1	1:A:165:ASN:HB3	2.43	0.53
1:C:120:THR:OG1	1:C:123:GLU:HG3	2.09	0.53
1:D:120:THR:OG1	1:D:123:GLU:HG3	2.08	0.53
1:E:303:LYS:O	1:E:307:VAL:HG23	2.09	0.53
1:B:309:LYS:HE3	1:C:196:ASN:HD21	1.74	0.53
1:D:85:TYR:CE1	1:D:165:ASN:HB3	2.44	0.52
1:B:139:LYS:HE3	1:B:140:TYR:CE2	2.43	0.52
1:F:237:PHE:CG	1:F:241:ARG:HG2	2.44	0.52
1:H:303:LYS:O	1:H:307:VAL:HG23	2.09	0.52
1:A:171:LYS:CB	1:A:175:VAL:HG11	2.39	0.52
1:F:171:LYS:CB	1:F:175:VAL:HG11	2.40	0.52
1:D:237:PHE:CG	1:D:241:ARG:HG2	2.45	0.52
1:H:237:PHE:CG	1:H:241:ARG:HG2	2.44	0.52
1:B:304:TYR:O	1:B:308:ILE:HG13	2.10	0.52
1:C:171:LYS:CB	1:C:175:VAL:HG11	2.37	0.52

Continued on next page...

Continued from previous page...

Atom-1	Atom-2	Interatomic distance (Å)	Clash overlap (Å)
1:E:237:PHE:CG	1:E:241:ARG:HG2	2.44	0.52
1:A:304:TYR:O	1:A:308:ILE:HG13	2.10	0.52
1:D:159:ARG:HD3	1:D:160:TYR:CZ	2.44	0.52
1:B:169:GLU:HA	1:B:206:GLN:O	2.10	0.52
1:G:139:LYS:HE3	1:G:140:TYR:CE2	2.46	0.51
1:H:304:TYR:O	1:H:308:ILE:HG13	2.10	0.51
1:G:237:PHE:CG	1:G:241:ARG:HG2	2.45	0.51
1:D:304:TYR:O	1:D:308:ILE:HG13	2.10	0.51
1:E:169:GLU:HA	1:E:206:GLN:O	2.10	0.51
1:F:139:LYS:HE3	1:F:140:TYR:CE2	2.44	0.51
1:G:303:LYS:O	1:G:307:VAL:HG23	2.10	0.51
1:A:120:THR:OG1	1:A:123:GLU:HG3	2.10	0.51
1:D:89:ASP:O	1:D:100:ALA:HA	2.10	0.51
1:F:169:GLU:HA	1:F:206:GLN:O	2.11	0.51
1:F:303:LYS:O	1:F:307:VAL:HG23	2.11	0.51
1:G:169:GLU:HA	1:G:206:GLN:O	2.10	0.51
1:C:159:ARG:HD3	1:C:160:TYR:CZ	2.46	0.51
1:E:171:LYS:CB	1:E:175:VAL:HG11	2.39	0.51
1:A:139:LYS:HE3	1:A:140:TYR:CE2	2.46	0.51
1:F:304:TYR:O	1:F:308:ILE:HG13	2.11	0.51
1:A:303:LYS:O	1:A:307:VAL:HG23	2.10	0.51
1:B:171:LYS:CB	1:B:175:VAL:HG11	2.38	0.51
1:C:237:PHE:CG	1:C:241:ARG:HG2	2.45	0.51
1:G:171:LYS:CB	1:G:175:VAL:HG11	2.39	0.51
1:A:237:PHE:CG	1:A:241:ARG:HG2	2.45	0.50
1:C:139:LYS:HE3	1:C:140:TYR:CE2	2.46	0.50
1:E:304:TYR:O	1:E:308:ILE:HG13	2.11	0.50
1:H:139:LYS:HE3	1:H:140:TYR:CE2	2.47	0.50
1:B:309:LYS:CE	1:C:196:ASN:HD21	2.25	0.50
1:C:235:GLN:CD	1:C:235:GLN:H	2.15	0.50
1:G:66:ALA:HB1	1:G:67:PRO:HD2	1.92	0.50
1:E:139:LYS:HE3	1:E:140:TYR:CE2	2.46	0.50
1:D:304:TYR:CE2	1:D:308:ILE:HD11	2.47	0.50
1:E:194:ASN:ND2	1:E:196:ASN:HB3	2.26	0.50
1:G:194:ASN:ND2	1:G:196:ASN:HB3	2.25	0.50
1:F:194:ASN:ND2	1:F:196:ASN:HB3	2.26	0.50
1:E:237:PHE:HB2	1:E:241:ARG:CG	2.42	0.49
1:E:280:ASN:HD21	1:E:299:ASN:HD22	1.60	0.49
1:A:194:ASN:ND2	1:A:196:ASN:HB3	2.27	0.49
1:B:237:PHE:HB2	1:B:241:ARG:CG	2.41	0.49
1:F:235:GLN:H	1:F:235:GLN:CD	2.15	0.49

Continued on next page...

Continued from previous page...

Atom-1	Atom-2	Interatomic distance (Å)	Clash overlap (Å)
1:E:89:ASP:O	1:E:100:ALA:HA	2.13	0.49
1:D:169:GLU:HA	1:D:206:GLN:O	2.12	0.49
1:E:235:GLN:CD	1:E:235:GLN:H	2.15	0.49
1:F:281:GLU:O	1:F:285:MET:HG3	2.13	0.49
1:B:66:ALA:HB1	1:B:67:PRO:HD2	1.94	0.49
1:D:235:GLN:H	1:D:235:GLN:CD	2.16	0.49
1:D:237:PHE:HB2	1:D:241:ARG:CG	2.42	0.49
1:G:89:ASP:O	1:G:100:ALA:HA	2.13	0.49
1:B:235:GLN:CD	1:B:235:GLN:H	2.16	0.48
1:D:303:LYS:O	1:D:307:VAL:HG23	2.13	0.48
1:H:66:ALA:HB1	1:H:67:PRO:HD2	1.95	0.48
1:H:169:GLU:HA	1:H:206:GLN:O	2.12	0.48
1:F:44:GLN:HE21	1:F:44:GLN:HB2	1.52	0.48
1:G:235:GLN:CD	1:G:235:GLN:H	2.17	0.48
1:H:237:PHE:HB2	1:H:241:ARG:CG	2.41	0.48
1:D:66:ALA:HB1	1:D:67:PRO:HD2	1.95	0.48
1:G:304:TYR:O	1:G:308:ILE:HG13	2.13	0.48
1:B:303:LYS:O	1:B:307:VAL:HG23	2.12	0.48
1:C:66:ALA:HB1	1:C:67:PRO:HD2	1.94	0.48
1:C:281:GLU:O	1:C:285:MET:HG3	2.14	0.48
1:A:237:PHE:HB2	1:A:241:ARG:CG	2.43	0.48
1:B:194:ASN:ND2	1:B:196:ASN:HB3	2.28	0.48
1:H:235:GLN:CD	1:H:235:GLN:H	2.15	0.48
1:C:303:LYS:O	1:C:307:VAL:HG23	2.14	0.48
1:D:139:LYS:HE3	1:D:140:TYR:CE2	2.48	0.48
1:H:194:ASN:ND2	1:H:196:ASN:HB3	2.27	0.48
1:C:237:PHE:HB2	1:C:241:ARG:CG	2.44	0.48
1:D:171:LYS:CB	1:D:175:VAL:HG11	2.40	0.48
1:D:194:ASN:ND2	1:D:196:ASN:HB3	2.29	0.48
1:E:66:ALA:HB1	1:E:67:PRO:HD2	1.96	0.48
1:A:169:GLU:HA	1:A:206:GLN:O	2.14	0.47
1:H:89:ASP:O	1:H:100:ALA:HA	2.14	0.47
1:F:263:ASN:OD1	1:F:264:THR:N	2.47	0.47
1:B:263:ASN:OD1	1:B:264:THR:N	2.48	0.47
1:C:44:GLN:HE21	1:C:44:GLN:HB2	1.50	0.47
1:H:263:ASN:OD1	1:H:264:THR:N	2.47	0.47
1:G:130:GLY:HA3	1:G:145:TYR:O	2.15	0.47
1:C:89:ASP:O	1:C:100:ALA:HA	2.15	0.47
1:C:263:ASN:OD1	1:C:264:THR:N	2.47	0.47
1:C:280:ASN:HD21	1:C:299:ASN:HD22	1.63	0.47
1:G:280:ASN:HD21	1:G:299:ASN:HD22	1.63	0.47

Continued on next page...

Continued from previous page...

Atom-1	Atom-2	Interatomic distance (Å)	Clash overlap (Å)
1:H:280:ASN:HD21	1:H:299:ASN:HD22	1.63	0.47
1:E:44:GLN:HE21	1:E:44:GLN:HB2	1.52	0.47
1:E:263:ASN:OD1	1:E:264:THR:N	2.47	0.47
1:F:237:PHE:HB2	1:F:241:ARG:CG	2.43	0.47
1:A:263:ASN:OD1	1:A:264:THR:N	2.48	0.47
1:H:85:TYR:CD1	1:H:165:ASN:HB3	2.50	0.47
1:G:237:PHE:HB2	1:G:241:ARG:CG	2.42	0.47
1:H:171:LYS:CB	1:H:175:VAL:HG11	2.39	0.47
1:C:169:GLU:HA	1:C:206:GLN:O	2.15	0.46
1:D:244:GLU:O	1:D:247:SER:OG	2.31	0.46
1:E:50:THR:O	1:E:51:ASN:HB3	2.16	0.46
1:E:281:GLU:O	1:E:285:MET:HG3	2.16	0.46
1:C:194:ASN:ND2	1:C:196:ASN:HB3	2.29	0.46
1:C:304:TYR:O	1:C:308:ILE:HG13	2.16	0.46
1:A:66:ALA:HB1	1:A:67:PRO:HD2	1.96	0.46
1:D:263:ASN:OD1	1:D:264:THR:N	2.48	0.46
1:A:235:GLN:H	1:A:235:GLN:CD	2.18	0.46
1:F:60:ARG:H	1:F:87:GLU:HB3	1.81	0.46
1:F:89:ASP:O	1:F:100:ALA:HA	2.16	0.46
1:G:95:ASP:OD1	1:G:95:ASP:N	2.45	0.46
1:B:280:ASN:HD21	1:B:299:ASN:HD22	1.63	0.46
1:E:88:ILE:HD11	1:E:156:ILE:HG21	1.98	0.46
1:H:281:GLU:O	1:H:285:MET:HG3	2.15	0.46
1:F:66:ALA:HB1	1:F:67:PRO:HD2	1.98	0.45
1:F:246:ARG:O	1:F:246:ARG:NH1	2.49	0.45
1:B:193:LEU:HD23	1:B:193:LEU:HA	1.83	0.45
1:C:50:THR:O	1:C:51:ASN:HB3	2.16	0.45
1:C:304:TYR:CE2	1:C:308:ILE:HD11	2.52	0.45
1:H:304:TYR:CE2	1:H:308:ILE:HD11	2.51	0.45
1:B:89:ASP:O	1:B:100:ALA:HA	2.15	0.45
1:G:304:TYR:CE2	1:G:308:ILE:HD11	2.52	0.45
1:G:44:GLN:HE21	1:G:44:GLN:HB2	1.54	0.45
1:D:246:ARG:O	1:D:246:ARG:NH1	2.50	0.45
1:H:112:GLY:O	1:H:113:HIS:HD2	2.00	0.45
1:C:302:ASP:OD1	1:C:303:LYS:N	2.50	0.45
1:H:130:GLY:HA3	1:H:145:TYR:O	2.17	0.45
1:A:89:ASP:O	1:A:100:ALA:HA	2.17	0.45
1:A:304:TYR:CE2	1:A:308:ILE:HD11	2.52	0.44
1:B:287:ARG:O	1:B:290:LYS:HB2	2.17	0.44
1:D:280:ASN:HD21	1:D:299:ASN:HD22	1.64	0.44
1:E:246:ARG:O	1:E:246:ARG:NH1	2.49	0.44

Continued on next page...

Continued from previous page...

Atom-1	Atom-2	Interatomic distance (Å)	Clash overlap (Å)
1:G:112:GLY:O	1:G:113:HIS:HD2	1.99	0.44
1:A:280:ASN:HD21	1:A:299:ASN:HD22	1.64	0.44
1:B:88:ILE:HD11	1:B:156:ILE:HG21	2.00	0.44
1:B:304:TYR:CE2	1:B:308:ILE:HD11	2.52	0.44
1:H:193:LEU:HD23	1:H:193:LEU:HA	1.81	0.44
1:D:229:VAL:HB	1:D:254:PRO:HA	1.99	0.44
1:G:262:GLN:H	1:G:262:GLN:HG3	1.63	0.44
1:B:113:HIS:CE1	1:H:119:TYR:CE1	3.05	0.44
1:C:246:ARG:O	1:C:246:ARG:NH1	2.50	0.44
1:F:85:TYR:CD1	1:F:165:ASN:HB3	2.53	0.44
1:G:281:GLU:O	1:G:285:MET:HG3	2.18	0.44
1:G:302:ASP:OD1	1:G:303:LYS:N	2.50	0.44
1:C:262:GLN:H	1:C:262:GLN:HG3	1.62	0.44
1:G:263:ASN:OD1	1:G:264:THR:N	2.50	0.44
1:A:44:GLN:HE21	1:A:44:GLN:HB2	1.52	0.44
1:A:246:ARG:O	1:A:246:ARG:NH1	2.51	0.44
1:F:262:GLN:H	1:F:262:GLN:HG3	1.63	0.44
1:E:193:LEU:HD23	1:E:193:LEU:HA	1.83	0.44
1:F:193:LEU:HD23	1:F:193:LEU:HA	1.82	0.44
1:F:229:VAL:HB	1:F:254:PRO:HA	2.00	0.44
1:F:302:ASP:OD1	1:F:303:LYS:N	2.50	0.44
1:A:229:VAL:HB	1:A:254:PRO:HA	2.00	0.43
1:A:281:GLU:O	1:A:285:MET:HG3	2.17	0.43
1:D:88:ILE:HD11	1:D:156:ILE:HG21	2.00	0.43
1:D:302:ASP:OD1	1:D:303:LYS:N	2.50	0.43
1:G:287:ARG:O	1:G:290:LYS:HB2	2.18	0.43
1:H:229:VAL:HB	1:H:254:PRO:HA	2.01	0.43
1:F:287:ARG:O	1:F:290:LYS:HB2	2.18	0.43
1:G:88:ILE:HD11	1:G:156:ILE:HG21	2.00	0.43
1:B:44:GLN:HE21	1:B:44:GLN:HB2	1.51	0.43
1:C:60:ARG:H	1:C:87:GLU:HB3	1.84	0.43
1:E:210:ASP:OD1	1:E:248:TYR:OH	2.35	0.43
1:F:130:GLY:HA3	1:F:145:TYR:O	2.18	0.43
1:C:165:ASN:OD1	1:C:202:HIS:HA	2.18	0.43
1:C:210:ASP:OD1	1:C:248:TYR:OH	2.34	0.43
1:E:228:LEU:HD13	3:E:501:GOL:H12	1.99	0.43
1:C:229:VAL:HB	1:C:254:PRO:HA	2.01	0.43
1:D:210:ASP:OD1	1:D:248:TYR:OH	2.36	0.43
1:F:112:GLY:O	1:F:113:HIS:HD2	2.02	0.43
1:F:280:ASN:HD21	1:F:299:ASN:HD22	1.67	0.43
1:F:304:TYR:CE2	1:F:308:ILE:HD11	2.52	0.43

Continued on next page...

Continued from previous page...

Atom-1	Atom-2	Interatomic distance (Å)	Clash overlap (Å)
1:H:246:ARG:O	1:H:246:ARG:NH1	2.50	0.43
1:D:112:GLY:O	1:D:113:HIS:HD2	2.02	0.43
1:E:85:TYR:CD1	1:E:165:ASN:HB3	2.54	0.43
1:F:172:SER:C	1:F:174:ASP:H	2.21	0.43
1:G:85:TYR:CD1	1:G:165:ASN:HB3	2.54	0.43
1:D:281:GLU:O	1:D:285:MET:HG3	2.19	0.43
1:D:287:ARG:O	1:D:290:LYS:HB2	2.19	0.43
1:G:172:SER:HA	1:G:173:PRO:HD3	1.90	0.43
1:H:278:THR:H	1:H:297:PHE:HB2	1.84	0.43
1:B:246:ARG:O	1:B:246:ARG:NH1	2.52	0.43
1:G:193:LEU:HD23	1:G:193:LEU:HA	1.81	0.43
1:A:210:ASP:OD1	1:A:248:TYR:OH	2.37	0.42
1:G:50:THR:O	1:G:51:ASN:HB3	2.19	0.42
1:B:113:HIS:CE1	1:H:119:TYR:CD1	3.08	0.42
1:B:165:ASN:OD1	1:B:202:HIS:HA	2.19	0.42
1:E:130:GLY:HA3	1:E:145:TYR:O	2.19	0.42
1:H:60:ARG:H	1:H:87:GLU:HB3	1.84	0.42
1:H:165:ASN:OD1	1:H:202:HIS:HA	2.19	0.42
1:A:72:GLN:OE1	1:A:72:GLN:N	2.48	0.42
1:D:172:SER:C	1:D:174:ASP:H	2.23	0.42
1:A:110:THR:HA	1:A:128:ASP:O	2.20	0.42
1:A:172:SER:HA	1:A:173:PRO:HD3	1.89	0.42
1:E:304:TYR:CE2	1:E:308:ILE:HD11	2.54	0.42
1:F:281:GLU:HB2	1:F:284:ASP:OD2	2.20	0.42
1:H:210:ASP:OD1	1:H:248:TYR:OH	2.37	0.42
1:B:85:TYR:CD1	1:B:165:ASN:HB3	2.54	0.42
1:D:44:GLN:HE21	1:D:44:GLN:HB2	1.52	0.42
1:E:112:GLY:O	1:E:113:HIS:HD2	2.02	0.42
1:E:165:ASN:OD1	1:E:202:HIS:HA	2.20	0.42
1:E:287:ARG:O	1:E:290:LYS:HB2	2.20	0.42
1:F:50:THR:O	1:F:51:ASN:HB3	2.20	0.42
1:H:76:LYS:O	1:H:80:GLU:HB3	2.20	0.42
1:B:210:ASP:OD1	1:B:248:TYR:OH	2.37	0.42
1:F:165:ASN:OD1	1:F:202:HIS:HA	2.20	0.42
1:A:88:ILE:HD11	1:A:156:ILE:HG21	2.02	0.42
1:B:229:VAL:HB	1:B:254:PRO:HA	2.02	0.42
1:D:181:GLU:HG2	1:G:182:GLN:HA	2.01	0.42
1:D:262:GLN:H	1:D:262:GLN:HG3	1.62	0.42
1:B:95:ASP:OD1	1:B:95:ASP:N	2.49	0.42
1:E:302:ASP:OD1	1:E:303:LYS:N	2.53	0.42
1:B:112:GLY:O	1:B:113:HIS:HD2	2.02	0.41

Continued on next page...

Continued from previous page...

Atom-1	Atom-2	Interatomic distance (Å)	Clash overlap (Å)
1:B:130:GLY:HA3	1:B:145:TYR:O	2.20	0.41
1:C:172:SER:HA	1:C:173:PRO:HD3	1.91	0.41
1:E:262:GLN:HE21	1:E:262:GLN:HB2	1.65	0.41
1:A:165:ASN:OD1	1:A:202:HIS:HA	2.20	0.41
1:B:278:THR:H	1:B:297:PHE:HB2	1.85	0.41
1:E:254:PRO:O	1:E:276:PRO:HA	2.20	0.41
1:H:88:ILE:HD11	1:H:156:ILE:HG21	2.02	0.41
1:A:50:THR:O	1:A:51:ASN:HB3	2.19	0.41
1:C:246:ARG:O	1:C:246:ARG:HG3	2.21	0.41
1:D:262:GLN:HE21	1:D:262:GLN:HB2	1.64	0.41
1:G:229:VAL:HB	1:G:254:PRO:HA	2.02	0.41
1:H:44:GLN:HE21	1:H:44:GLN:HB2	1.53	0.41
1:H:59:HIS:HE2	3:H:501:GOL:HO2	1.66	0.41
1:B:302:ASP:OD1	1:B:303:LYS:N	2.54	0.41
1:E:229:VAL:HB	1:E:254:PRO:HA	2.02	0.41
1:F:95:ASP:OD1	1:F:95:ASP:N	2.43	0.41
1:H:155:GLU:O	1:H:158:GLU:HB3	2.21	0.41
1:H:172:SER:C	1:H:174:ASP:H	2.22	0.41
1:A:61:GLY:C	1:A:63:SER:H	2.24	0.41
1:A:112:GLY:O	1:A:113:HIS:HD2	2.03	0.41
1:B:172:SER:C	1:B:174:ASP:H	2.23	0.41
1:E:60:ARG:H	1:E:87:GLU:HB3	1.86	0.41
1:E:281:GLU:HB2	1:E:284:ASP:OD2	2.21	0.41
1:G:246:ARG:O	1:G:246:ARG:NH1	2.53	0.41
1:D:50:THR:O	1:D:51:ASN:HB3	2.21	0.41
1:G:281:GLU:HB2	1:G:284:ASP:OD2	2.19	0.41
1:H:262:GLN:H	1:H:262:GLN:HG3	1.65	0.41
1:C:278:THR:H	1:C:297:PHE:HB2	1.86	0.41
1:F:246:ARG:O	1:F:246:ARG:HG3	2.21	0.41
1:G:210:ASP:OD1	1:G:248:TYR:OH	2.37	0.41
1:C:85:TYR:CD1	1:C:165:ASN:HB3	2.56	0.41
1:C:191:HIS:CE1	1:D:139:LYS:HB3	2.56	0.41
1:C:287:ARG:O	1:C:290:LYS:HB2	2.20	0.41
1:D:278:THR:H	1:D:297:PHE:HB2	1.86	0.41
1:G:262:GLN:NE2	1:G:263:ASN:N	2.69	0.41
1:H:287:ARG:O	1:H:290:LYS:HB2	2.21	0.41
1:A:45:TRP:CD2	1:A:268:LYS:HB3	2.56	0.41
1:B:181:GLU:HB3	1:E:181:GLU:HB3	2.02	0.41
1:C:281:GLU:HB2	1:C:284:ASP:OD2	2.21	0.41
1:E:278:THR:H	1:E:297:PHE:HB2	1.85	0.41
1:H:246:ARG:O	1:H:246:ARG:HG3	2.21	0.41

Continued on next page...

Continued from previous page...

Atom-1	Atom-2	Interatomic distance (Å)	Clash overlap (Å)
1:H:281:GLU:HB2	1:H:284:ASP:OD2	2.21	0.41
1:A:60:ARG:H	1:A:87:GLU:HB3	1.85	0.40
1:A:95:ASP:OD1	1:A:95:ASP:N	2.47	0.40
1:B:281:GLU:HB2	1:B:284:ASP:OD2	2.21	0.40
1:F:235:GLN:CD	1:F:235:GLN:N	2.74	0.40
1:G:278:THR:H	1:G:297:PHE:HB2	1.87	0.40
1:B:124:LEU:HD12	1:B:127:LEU:HD12	2.03	0.40
1:D:261:GLU:O	1:D:265:HIS:ND1	2.53	0.40
1:G:172:SER:C	1:G:174:ASP:H	2.24	0.40
1:B:45:TRP:CD2	1:B:268:LYS:HB3	2.57	0.40
1:G:120:THR:O	1:G:121:LEU:C	2.60	0.40
1:H:104:GLU:O	1:H:116:VAL:HG23	2.21	0.40
1:B:50:THR:O	1:B:51:ASN:HB3	2.22	0.40
1:C:112:GLY:O	1:C:113:HIS:HD2	2.03	0.40
1:G:60:ARG:H	1:G:87:GLU:HB3	1.87	0.40
1:B:235:GLN:CD	1:B:235:GLN:N	2.75	0.40
1:B:281:GLU:O	1:B:285:MET:HG3	2.21	0.40
1:D:281:GLU:HB2	1:D:284:ASP:OD2	2.21	0.40
1:H:262:GLN:NE2	1:H:263:ASN:N	2.70	0.40

There are no symmetry-related clashes.

5.3 Torsion angles [i](#)

5.3.1 Protein backbone [i](#)

In the following table, the Percentiles column shows the percent Ramachandran outliers of the chain as a percentile score with respect to all X-ray entries followed by that with respect to entries of similar resolution.

The Analysed column shows the number of residues for which the backbone conformation was analysed, and the total number of residues.

Mol	Chain	Analysed	Favoured	Allowed	Outliers	Percentiles
1	A	265/287 (92%)	244 (92%)	18 (7%)	3 (1%)	14 30
1	B	265/287 (92%)	246 (93%)	16 (6%)	3 (1%)	14 30
1	C	265/287 (92%)	246 (93%)	16 (6%)	3 (1%)	14 30
1	D	265/287 (92%)	245 (92%)	17 (6%)	3 (1%)	14 30
1	E	265/287 (92%)	244 (92%)	18 (7%)	3 (1%)	14 30

Continued on next page...

Continued from previous page...

Mol	Chain	Analysed	Favoured	Allowed	Outliers	Percentiles	
1	F	265/287 (92%)	244 (92%)	18 (7%)	3 (1%)	14	30
1	G	265/287 (92%)	242 (91%)	20 (8%)	3 (1%)	14	30
1	H	265/287 (92%)	243 (92%)	19 (7%)	3 (1%)	14	30
All	All	2120/2296 (92%)	1954 (92%)	142 (7%)	24 (1%)	14	30

All (24) Ramachandran outliers are listed below:

Mol	Chain	Res	Type
1	C	236	GLN
1	F	141	ALA
1	G	141	ALA
1	H	141	ALA
1	A	236	GLN
1	A	238	ASN
1	B	141	ALA
1	B	238	ASN
1	C	141	ALA
1	C	238	ASN
1	D	141	ALA
1	D	236	GLN
1	D	238	ASN
1	E	141	ALA
1	E	238	ASN
1	F	236	GLN
1	G	238	ASN
1	H	236	GLN
1	H	238	ASN
1	A	141	ALA
1	B	236	GLN
1	E	236	GLN
1	F	238	ASN
1	G	236	GLN

5.3.2 Protein sidechains [i](#)

In the following table, the Percentiles column shows the percent sidechain outliers of the chain as a percentile score with respect to all X-ray entries followed by that with respect to entries of similar resolution.

The Analysed column shows the number of residues for which the sidechain conformation was analysed, and the total number of residues.

Mol	Chain	Analysed	Rotameric	Outliers	Percentiles	
1	A	237/254 (93%)	231 (98%)	6 (2%)	47	73
1	B	237/254 (93%)	231 (98%)	6 (2%)	47	73
1	C	237/254 (93%)	231 (98%)	6 (2%)	47	73
1	D	237/254 (93%)	231 (98%)	6 (2%)	47	73
1	E	237/254 (93%)	230 (97%)	7 (3%)	41	67
1	F	237/254 (93%)	231 (98%)	6 (2%)	47	73
1	G	237/254 (93%)	231 (98%)	6 (2%)	47	73
1	H	237/254 (93%)	231 (98%)	6 (2%)	47	73
All	All	1896/2032 (93%)	1847 (97%)	49 (3%)	46	72

All (49) residues with a non-rotameric sidechain are listed below:

Mol	Chain	Res	Type
1	A	44	GLN
1	A	167	TYR
1	A	171	LYS
1	A	174	ASP
1	A	262	GLN
1	A	278	THR
1	B	44	GLN
1	B	167	TYR
1	B	171	LYS
1	B	174	ASP
1	B	262	GLN
1	B	278	THR
1	C	44	GLN
1	C	167	TYR
1	C	171	LYS
1	C	174	ASP
1	C	262	GLN
1	C	278	THR
1	D	44	GLN
1	D	167	TYR
1	D	171	LYS
1	D	174	ASP
1	D	262	GLN
1	D	278	THR
1	E	44	GLN
1	E	167	TYR
1	E	171	LYS

Continued on next page...

Continued from previous page...

Mol	Chain	Res	Type
1	E	174	ASP
1	E	194	ASN
1	E	262	GLN
1	E	278	THR
1	F	44	GLN
1	F	167	TYR
1	F	171	LYS
1	F	174	ASP
1	F	262	GLN
1	F	278	THR
1	G	44	GLN
1	G	167	TYR
1	G	171	LYS
1	G	174	ASP
1	G	262	GLN
1	G	278	THR
1	H	44	GLN
1	H	167	TYR
1	H	171	LYS
1	H	174	ASP
1	H	262	GLN
1	H	278	THR

Sometimes sidechains can be flipped to improve hydrogen bonding and reduce clashes. All (84) such sidechains are listed below:

Mol	Chain	Res	Type
1	A	44	GLN
1	A	46	HIS
1	A	79	ASN
1	A	113	HIS
1	A	219	GLN
1	A	235	GLN
1	A	236	GLN
1	A	262	GLN
1	A	289	ASN
1	A	299	ASN
1	B	44	GLN
1	B	46	HIS
1	B	79	ASN
1	B	102	HIS
1	B	113	HIS
1	B	219	GLN

Continued on next page...

Continued from previous page...

Mol	Chain	Res	Type
1	B	235	GLN
1	B	236	GLN
1	B	262	GLN
1	B	289	ASN
1	B	299	ASN
1	C	44	GLN
1	C	46	HIS
1	C	79	ASN
1	C	102	HIS
1	C	113	HIS
1	C	191	HIS
1	C	196	ASN
1	C	219	GLN
1	C	235	GLN
1	C	236	GLN
1	C	262	GLN
1	C	289	ASN
1	C	299	ASN
1	D	44	GLN
1	D	46	HIS
1	D	102	HIS
1	D	113	HIS
1	D	219	GLN
1	D	235	GLN
1	D	236	GLN
1	D	262	GLN
1	D	289	ASN
1	D	299	ASN
1	E	44	GLN
1	E	46	HIS
1	E	79	ASN
1	E	113	HIS
1	E	219	GLN
1	E	235	GLN
1	E	236	GLN
1	E	262	GLN
1	E	289	ASN
1	E	299	ASN
1	F	44	GLN
1	F	46	HIS
1	F	79	ASN
1	F	113	HIS

Continued on next page...

Continued from previous page...

Mol	Chain	Res	Type
1	F	219	GLN
1	F	235	GLN
1	F	236	GLN
1	F	262	GLN
1	F	289	ASN
1	F	299	ASN
1	G	44	GLN
1	G	46	HIS
1	G	79	ASN
1	G	113	HIS
1	G	219	GLN
1	G	235	GLN
1	G	236	GLN
1	G	289	ASN
1	G	299	ASN
1	H	44	GLN
1	H	46	HIS
1	H	79	ASN
1	H	102	HIS
1	H	113	HIS
1	H	219	GLN
1	H	235	GLN
1	H	236	GLN
1	H	262	GLN
1	H	289	ASN
1	H	299	ASN

5.3.3 RNA [i](#)

There are no RNA molecules in this entry.

5.4 Non-standard residues in protein, DNA, RNA chains [i](#)

There are no non-standard protein/DNA/RNA residues in this entry.

5.5 Carbohydrates [i](#)

There are no monosaccharides in this entry.

5.6 Ligand geometry

Of 16 ligands modelled in this entry, 8 are monoatomic - leaving 8 for Mogul analysis.

In the following table, the Counts columns list the number of bonds (or angles) for which Mogul statistics could be retrieved, the number of bonds (or angles) that are observed in the model and the number of bonds (or angles) that are defined in the Chemical Component Dictionary. The Link column lists molecule types, if any, to which the group is linked. The Z score for a bond length (or angle) is the number of standard deviations the observed value is removed from the expected value. A bond length (or angle) with $|Z| > 2$ is considered an outlier worth inspection. RMSZ is the root-mean-square of all Z scores of the bond lengths (or angles).

Mol	Type	Chain	Res	Link	Bond lengths			Bond angles		
					Counts	RMSZ	# Z > 2	Counts	RMSZ	# Z > 2
3	GOL	H	501	2	5,5,5	0.41	0	5,5,5	0.36	0
3	GOL	D	501	2	5,5,5	0.56	0	5,5,5	0.25	0
3	GOL	F	501	2	5,5,5	0.43	0	5,5,5	0.31	0
3	GOL	E	501	2	5,5,5	0.50	0	5,5,5	0.28	0
3	GOL	C	501	2	5,5,5	0.42	0	5,5,5	0.30	0
3	GOL	G	501	2	5,5,5	0.31	0	5,5,5	0.31	0
3	GOL	A	501	2	5,5,5	0.35	0	5,5,5	0.32	0
3	GOL	B	501	2	5,5,5	0.74	0	5,5,5	0.28	0

In the following table, the Chirals column lists the number of chiral outliers, the number of chiral centers analysed, the number of these observed in the model and the number defined in the Chemical Component Dictionary. Similar counts are reported in the Torsion and Rings columns. '-' means no outliers of that kind were identified.

Mol	Type	Chain	Res	Link	Chirals	Torsions	Rings
3	GOL	H	501	2	-	2/4/4/4	-
3	GOL	D	501	2	-	4/4/4/4	-
3	GOL	F	501	2	-	2/4/4/4	-
3	GOL	E	501	2	-	4/4/4/4	-
3	GOL	C	501	2	-	4/4/4/4	-
3	GOL	G	501	2	-	2/4/4/4	-
3	GOL	A	501	2	-	2/4/4/4	-
3	GOL	B	501	2	-	4/4/4/4	-

There are no bond length outliers.

There are no bond angle outliers.

There are no chirality outliers.

All (24) torsion outliers are listed below:

Mol	Chain	Res	Type	Atoms
3	B	501	GOL	C1-C2-C3-O3
3	C	501	GOL	O1-C1-C2-C3
3	C	501	GOL	C1-C2-C3-O3
3	D	501	GOL	C1-C2-C3-O3
3	E	501	GOL	O1-C1-C2-C3
3	C	501	GOL	O2-C2-C3-O3
3	A	501	GOL	O1-C1-C2-C3
3	B	501	GOL	O1-C1-C2-C3
3	D	501	GOL	O1-C1-C2-C3
3	E	501	GOL	C1-C2-C3-O3
3	F	501	GOL	O1-C1-C2-C3
3	G	501	GOL	O1-C1-C2-C3
3	H	501	GOL	O1-C1-C2-C3
3	B	501	GOL	O2-C2-C3-O3
3	C	501	GOL	O1-C1-C2-O2
3	E	501	GOL	O2-C2-C3-O3
3	G	501	GOL	O1-C1-C2-O2
3	A	501	GOL	O1-C1-C2-O2
3	B	501	GOL	O1-C1-C2-O2
3	D	501	GOL	O1-C1-C2-O2
3	D	501	GOL	O2-C2-C3-O3
3	E	501	GOL	O1-C1-C2-O2
3	F	501	GOL	O1-C1-C2-O2
3	H	501	GOL	O1-C1-C2-O2

There are no ring outliers.

3 monomers are involved in 3 short contacts:

Mol	Chain	Res	Type	Clashes	Symm-Clashes
3	H	501	GOL	1	0
3	E	501	GOL	1	0
3	B	501	GOL	1	0

5.7 Other polymers [\(i\)](#)

There are no such residues in this entry.

5.8 Polymer linkage issues [\(i\)](#)

There are no chain breaks in this entry.

6 Fit of model and data

6.1 Protein, DNA and RNA chains

In the following table, the column labelled ‘#RSRZ > 2’ contains the number (and percentage) of RSRZ outliers, followed by percent RSRZ outliers for the chain as percentile scores relative to all X-ray entries and entries of similar resolution. The OWAB column contains the minimum, median, 95th percentile and maximum values of the occupancy-weighted average B-factor per residue. The column labelled ‘Q < 0.9’ lists the number of (and percentage) of residues with an average occupancy less than 0.9.

Mol	Chain	Analysed	<RSRZ>	#RSRZ>2	OWAB(Å ²)	Q<0.9
1	A	267/287 (93%)	0.27	11 (4%) 37 30	29, 52, 82, 107	0
1	B	267/287 (93%)	0.38	7 (2%) 56 50	46, 59, 84, 109	0
1	C	267/287 (93%)	0.28	8 (2%) 50 43	32, 54, 81, 110	0
1	D	267/287 (93%)	0.10	5 (1%) 66 62	32, 53, 83, 107	0
1	E	267/287 (93%)	0.26	8 (2%) 50 43	42, 60, 84, 109	0
1	F	267/287 (93%)	0.30	9 (3%) 45 38	40, 59, 85, 111	0
1	G	267/287 (93%)	0.32	9 (3%) 45 38	43, 61, 84, 112	0
1	H	267/287 (93%)	0.36	12 (4%) 33 26	36, 60, 85, 110	0
All	All	2136/2296 (93%)	0.28	69 (3%) 47 40	29, 58, 84, 112	0

All (69) RSRZ outliers are listed below:

Mol	Chain	Res	Type	RSRZ
1	B	242	LEU	4.6
1	H	243	LYS	4.4
1	G	262	GLN	4.2
1	A	240	GLN	4.2
1	H	139	LYS	3.8
1	F	240	GLN	3.6
1	F	234	LEU	3.4
1	C	242	LEU	3.3
1	E	270	LEU	3.3
1	H	237	PHE	3.3
1	H	44	GLN	3.3
1	G	270	LEU	3.3
1	F	237	PHE	3.3
1	F	235	GLN	3.3
1	D	243	LYS	3.2
1	A	235	GLN	3.2

Continued on next page...

Continued from previous page...

Mol	Chain	Res	Type	RSRZ
1	D	270	LEU	3.1
1	C	237	PHE	3.0
1	B	106	VAL	3.0
1	A	234	LEU	3.0
1	C	113	HIS	2.9
1	F	236	GLN	2.9
1	B	240	GLN	2.8
1	A	242	LEU	2.8
1	C	174	ASP	2.8
1	H	229	VAL	2.8
1	A	236	GLN	2.8
1	E	238	ASN	2.8
1	E	113	HIS	2.7
1	B	286	LEU	2.7
1	E	240	GLN	2.7
1	E	243	LYS	2.6
1	H	173	PRO	2.6
1	G	44	GLN	2.6
1	F	242	LEU	2.6
1	F	121	LEU	2.6
1	C	139	LYS	2.5
1	B	239	ASP	2.5
1	F	262	GLN	2.4
1	H	242	LEU	2.4
1	H	236	GLN	2.4
1	G	139	LYS	2.4
1	A	237	PHE	2.4
1	H	310	GLU	2.4
1	H	133	PHE	2.4
1	H	140	TYR	2.3
1	C	259	LEU	2.3
1	E	173	PRO	2.3
1	B	146	LYS	2.3
1	B	243	LYS	2.3
1	D	236	GLN	2.2
1	G	235	GLN	2.2
1	A	239	ASP	2.2
1	G	238	ASN	2.2
1	A	173	PRO	2.2
1	F	147	ASN	2.2
1	A	243	LYS	2.2
1	A	50	THR	2.2

Continued on next page...

Continued from previous page...

Mol	Chain	Res	Type	RSRZ
1	C	235	GLN	2.1
1	E	237	PHE	2.1
1	A	310	GLU	2.1
1	E	135	LYS	2.1
1	G	242	LEU	2.1
1	C	238	ASN	2.1
1	G	240	GLN	2.0
1	H	235	GLN	2.0
1	G	237	PHE	2.0
1	D	242	LEU	2.0
1	D	244	GLU	2.0

6.2 Non-standard residues in protein, DNA, RNA chains [i](#)

There are no non-standard protein/DNA/RNA residues in this entry.

6.3 Carbohydrates [i](#)

There are no monosaccharides in this entry.

6.4 Ligands [i](#)

In the following table, the Atoms column lists the number of modelled atoms in the group and the number defined in the chemical component dictionary. The B-factors column lists the minimum, median, 95th percentile and maximum values of B factors of atoms in the group. The column labelled 'Q<0.9' lists the number of atoms with occupancy less than 0.9.

Mol	Type	Chain	Res	Atoms	RSCC	RSR	B-factors(Å ²)	Q<0.9
3	GOL	B	501	6/6	0.84	0.28	58,62,64,68	0
3	GOL	H	501	6/6	0.84	0.18	58,62,63,67	0
3	GOL	F	501	6/6	0.87	0.27	58,62,63,68	0
3	GOL	G	501	6/6	0.90	0.27	52,56,58,61	0
3	GOL	D	501	6/6	0.90	0.22	52,54,56,61	0
3	GOL	A	501	6/6	0.91	0.24	42,47,48,53	0
2	NA	B	401	1/1	0.91	0.43	55,55,55,55	0
3	GOL	E	501	6/6	0.94	0.21	53,59,60,64	0
3	GOL	C	501	6/6	0.95	0.25	49,52,54,60	0
2	NA	C	401	1/1	0.95	0.35	32,32,32,32	0
2	NA	D	401	1/1	0.96	0.40	46,46,46,46	0
2	NA	E	401	1/1	0.97	0.35	36,36,36,36	0

Continued on next page...

Continued from previous page...

Mol	Type	Chain	Res	Atoms	RSCC	RSR	B-factors(\AA^2)	Q<0.9
2	NA	H	401	1/1	0.97	0.43	43,43,43,43	0
2	NA	F	401	1/1	0.98	0.35	34,34,34,34	0
2	NA	G	401	1/1	0.99	0.40	35,35,35,35	0
2	NA	A	401	1/1	0.99	0.41	41,41,41,41	0

6.5 Other polymers [i](#)

There are no such residues in this entry.