



Full wwPDB X-ray Structure Validation Report ⓘ

Aug 20, 2023 – 07:39 AM EDT

PDB ID : 2OOG
Title : Crystal structure of glycerophosphoryl diester phosphodiesterase from *Staphylococcus aureus*
Authors : Patskovsky, Y.; Fedorov, E.; Toro, R.; Sauder, J.M.; Smith, D.; Freeman, J.; Maletic, M.; Powell, A.; Gheyi, T.; Wasserman, S.R.; Burley, S.K.; Almo, S.C.; New York SGX Research Center for Structural Genomics (NYSGXRC)
Deposited on : 2007-01-25
Resolution : 2.20 Å(reported)

This is a Full wwPDB X-ray Structure Validation Report for a publicly released PDB entry.

We welcome your comments at validation@mail.wwpdb.org

A user guide is available at

<https://www.wwpdb.org/validation/2017/XrayValidationReportHelp>

with specific help available everywhere you see the ⓘ symbol.

The types of validation reports are described at

<http://www.wwpdb.org/validation/2017/FAQs#types>.

The following versions of software and data (see [references ⓘ](#)) were used in the production of this report:

MolProbity : 4.02b-467
Mogul : 1.8.5 (274361), CSD as541be (2020)
Xtrriage (Phenix) : 1.13
EDS : 2.35
Percentile statistics : 20191225.v01 (using entries in the PDB archive December 25th 2019)
Refmac : 5.8.0158
CCP4 : 7.0.044 (Gargrove)
Ideal geometry (proteins) : Engh & Huber (2001)
Ideal geometry (DNA, RNA) : Parkinson et al. (1996)
Validation Pipeline (wwPDB-VP) : 2.35

1 Overall quality at a glance

The following experimental techniques were used to determine the structure:

X-RAY DIFFRACTION

The reported resolution of this entry is 2.20 Å.

Percentile scores (ranging between 0-100) for global validation metrics of the entry are shown in the following graphic. The table shows the number of entries on which the scores are based.

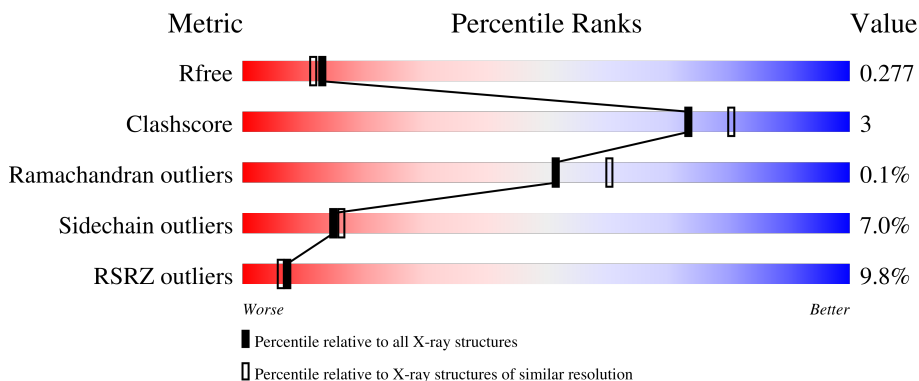

Metric	Whole archive (#Entries)	Similar resolution (#Entries, resolution range(Å))
R_{free}	130704	4898 (2.20-2.20)
Clashscore	141614	5594 (2.20-2.20)
Ramachandran outliers	138981	5503 (2.20-2.20)
Sidechain outliers	138945	5504 (2.20-2.20)
RSRZ outliers	127900	4800 (2.20-2.20)

The table below summarises the geometric issues observed across the polymeric chains and their fit to the electron density. The red, orange, yellow and green segments of the lower bar indicate the fraction of residues that contain outliers for ≥ 3 , 2, 1 and 0 types of geometric quality criteria respectively. A grey segment represents the fraction of residues that are not modelled. The numeric value for each fraction is indicated below the corresponding segment, with a dot representing fractions $\leq 5\%$. The upper red bar (where present) indicates the fraction of residues that have poor fit to the electron density. The numeric value is given above the bar.

Mol	Chain	Length	Quality of chain
1	A	287	 2% 80% 11% 7%
1	B	287	 2% 84% 8% 7%
1	C	287	 16% 82% 10% 7%
1	D	287	 3% 84% 9% 7%

Continued on next page...

Continued from previous page...

Mol	Chain	Length	Quality of chain
1	E	287	
1	F	287	

The following table lists non-polymeric compounds, carbohydrate monomers and non-standard residues in protein, DNA, RNA chains that are outliers for geometric or electron-density-fit criteria:

Mol	Type	Chain	Res	Chirality	Geometry	Clashes	Electron density
4	GOL	A	476	-	-	X	-
4	GOL	B	469	-	-	-	X
4	GOL	E	467	-	-	X	-

2 Entry composition [i](#)

There are 5 unique types of molecules in this entry. The entry contains 14474 atoms, of which 0 are hydrogens and 0 are deuteriums.

In the tables below, the ZeroOcc column contains the number of atoms modelled with zero occupancy, the AltConf column contains the number of residues with at least one atom in alternate conformation and the Trace column contains the number of residues modelled with at most 2 atoms.

- Molecule 1 is a protein called Glycerophosphoryl diester phosphodiesterase.

Mol	Chain	Residues	Atoms					ZeroOcc	AltConf	Trace
			Total	C	N	O	S			
1	A	267	2238	1418	392	424	4	0	10	0
1	B	267	2233	1413	392	424	4	0	9	0
1	C	267	2216	1400	393	419	4	0	5	0
1	D	268	2223	1406	392	421	4	0	6	0
1	E	267	2200	1392	386	418	4	0	3	0
1	F	267	2203	1392	389	418	4	0	3	0

There are 48 discrepancies between the modelled and reference sequences:

Chain	Residue	Modelled	Actual	Comment	Reference
A	310	GLU	-	expression tag	UNP Q7A6H7
A	311	GLY	-	expression tag	UNP Q7A6H7
A	312	HIS	-	expression tag	UNP Q7A6H7
A	313	HIS	-	expression tag	UNP Q7A6H7
A	314	HIS	-	expression tag	UNP Q7A6H7
A	315	HIS	-	expression tag	UNP Q7A6H7
A	316	HIS	-	expression tag	UNP Q7A6H7
A	317	HIS	-	expression tag	UNP Q7A6H7
B	310	GLU	-	expression tag	UNP Q7A6H7
B	311	GLY	-	expression tag	UNP Q7A6H7
B	312	HIS	-	expression tag	UNP Q7A6H7
B	313	HIS	-	expression tag	UNP Q7A6H7
B	314	HIS	-	expression tag	UNP Q7A6H7
B	315	HIS	-	expression tag	UNP Q7A6H7
B	316	HIS	-	expression tag	UNP Q7A6H7
B	317	HIS	-	expression tag	UNP Q7A6H7
C	310	GLU	-	expression tag	UNP Q7A6H7

Continued on next page...

Continued from previous page...

Chain	Residue	Modelled	Actual	Comment	Reference
C	311	GLY	-	expression tag	UNP Q7A6H7
C	312	HIS	-	expression tag	UNP Q7A6H7
C	313	HIS	-	expression tag	UNP Q7A6H7
C	314	HIS	-	expression tag	UNP Q7A6H7
C	315	HIS	-	expression tag	UNP Q7A6H7
C	316	HIS	-	expression tag	UNP Q7A6H7
C	317	HIS	-	expression tag	UNP Q7A6H7
D	310	GLU	-	expression tag	UNP Q7A6H7
D	311	GLY	-	expression tag	UNP Q7A6H7
D	312	HIS	-	expression tag	UNP Q7A6H7
D	313	HIS	-	expression tag	UNP Q7A6H7
D	314	HIS	-	expression tag	UNP Q7A6H7
D	315	HIS	-	expression tag	UNP Q7A6H7
D	316	HIS	-	expression tag	UNP Q7A6H7
D	317	HIS	-	expression tag	UNP Q7A6H7
E	310	GLU	-	expression tag	UNP Q7A6H7
E	311	GLY	-	expression tag	UNP Q7A6H7
E	312	HIS	-	expression tag	UNP Q7A6H7
E	313	HIS	-	expression tag	UNP Q7A6H7
E	314	HIS	-	expression tag	UNP Q7A6H7
E	315	HIS	-	expression tag	UNP Q7A6H7
E	316	HIS	-	expression tag	UNP Q7A6H7
E	317	HIS	-	expression tag	UNP Q7A6H7
F	310	GLU	-	expression tag	UNP Q7A6H7
F	311	GLY	-	expression tag	UNP Q7A6H7
F	312	HIS	-	expression tag	UNP Q7A6H7
F	313	HIS	-	expression tag	UNP Q7A6H7
F	314	HIS	-	expression tag	UNP Q7A6H7
F	315	HIS	-	expression tag	UNP Q7A6H7
F	316	HIS	-	expression tag	UNP Q7A6H7
F	317	HIS	-	expression tag	UNP Q7A6H7

- Molecule 2 is ZINC ION (three-letter code: ZN) (formula: Zn).

Mol	Chain	Residues	Atoms	ZeroOcc	AltConf
2	A	1	Total Zn 1 1	0	0
2	B	1	Total Zn 1 1	0	0
2	C	1	Total Zn 1 1	0	0
2	D	1	Total Zn 1 1	0	0

Continued on next page...

Continued from previous page...

Mol	Chain	Residues	Atoms		ZeroOcc	AltConf
2	E	1	Total	Zn	0	0
			1	1		
2	F	1	Total	Zn	0	0
			1	1		

- Molecule 3 is SULFATE ION (three-letter code: SO4) (formula: O₄S).

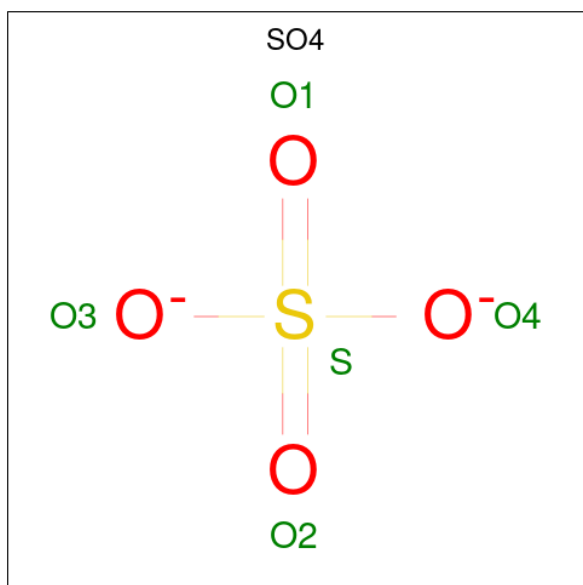

Mol	Chain	Residues	Atoms			ZeroOcc	AltConf
3	A	1	Total	O	S	0	0
			5	4	1		
3	A	1	Total	O	S	0	0
			5	4	1		
3	A	1	Total	O	S	0	0
			5	4	1		
3	B	1	Total	O	S	0	0
			5	4	1		
3	C	1	Total	O	S	0	0
			5	4	1		
3	D	1	Total	O	S	0	0
			5	4	1		

- Molecule 4 is GLYCEROL (three-letter code: GOL) (formula: C₃H₈O₃).



Mol	Chain	Residues	Atoms	ZeroOcc	AltConf
4	A	1	Total C O 6 3 3	0	0
4	A	1	Total C O 6 3 3	0	0
4	A	1	Total C O 6 3 3	0	0
4	A	1	Total C O 6 3 3	0	0
4	A	1	Total C O 6 3 3	0	0
4	A	1	Total C O 6 3 3	0	0
4	B	1	Total C O 6 3 3	0	0
4	B	1	Total C O 6 3 3	0	0
4	B	1	Total C O 6 3 3	0	0
4	B	1	Total C O 6 3 3	0	0
4	B	1	Total C O 6 3 3	0	0
4	B	1	Total C O 6 3 3	0	0
4	B	1	Total C O 6 3 3	0	0
4	B	1	Total C O 6 3 3	0	0

Continued on next page...

Continued from previous page...

Mol	Chain	Residues	Atoms			ZeroOcc	AltConf
4	B	1	Total 6	C 3	O 3	0	0
4	B	1	Total 6	C 3	O 3	0	0
4	C	1	Total 6	C 3	O 3	0	0
4	C	1	Total 6	C 3	O 3	0	0
4	D	1	Total 6	C 3	O 3	0	0
4	D	1	Total 6	C 3	O 3	0	0
4	D	1	Total 6	C 3	O 3	0	0
4	D	1	Total 6	C 3	O 3	0	0
4	D	1	Total 6	C 3	O 3	0	0
4	D	1	Total 6	C 3	O 3	0	0
4	D	1	Total 6	C 3	O 3	0	0
4	D	1	Total 6	C 3	O 3	0	0
4	D	1	Total 6	C 3	O 3	0	0
4	D	1	Total 6	C 3	O 3	0	0
4	D	1	Total 6	C 3	O 3	0	0
4	E	1	Total 6	C 3	O 3	0	0
4	E	1	Total 6	C 3	O 3	0	0
4	E	1	Total 6	C 3	O 3	0	0
4	E	1	Total 6	C 3	O 3	0	0
4	E	1	Total 6	C 3	O 3	0	0
4	E	1	Total 6	C 3	O 3	0	0
4	F	1	Total 6	C 3	O 3	0	0
4	F	1	Total 6	C 3	O 3	0	0
4	F	1	Total 6	C 3	O 3	0	0

Continued on next page...

Continued from previous page...

Mol	Chain	Residues	Atoms			ZeroOcc	AltConf
4	F	1	Total	C	O	0	0
			6	3	3		
4	F	1	Total	C	O	0	0
			6	3	3		
4	F	1	Total	C	O	0	0
			6	3	3		
4	F	1	Total	C	O	0	0
			6	3	3		

- Molecule 5 is water.

Mol	Chain	Residues	Atoms		ZeroOcc	AltConf
5	A	198	Total	O	0	0
			198	198		
5	B	211	Total	O	0	0
			211	211		
5	C	87	Total	O	0	0
			87	87		
5	D	193	Total	O	0	0
			193	193		
5	E	92	Total	O	0	0
			92	92		
5	F	110	Total	O	0	0
			110	110		

3 Residue-property plots [i](#)

These plots are drawn for all protein, RNA, DNA and oligosaccharide chains in the entry. The first graphic for a chain summarises the proportions of the various outlier classes displayed in the second graphic. The second graphic shows the sequence view annotated by issues in geometry and electron density. Residues are color-coded according to the number of geometric quality criteria for which they contain at least one outlier: green = 0, yellow = 1, orange = 2 and red = 3 or more. A red dot above a residue indicates a poor fit to the electron density ($RSRZ > 2$). Stretches of 2 or more consecutive residues without any outlier are shown as a green connector. Residues present in the sample, but not in the model, are shown in grey.

- Molecule 1: Glycerophosphoryl diester phosphodiesterase

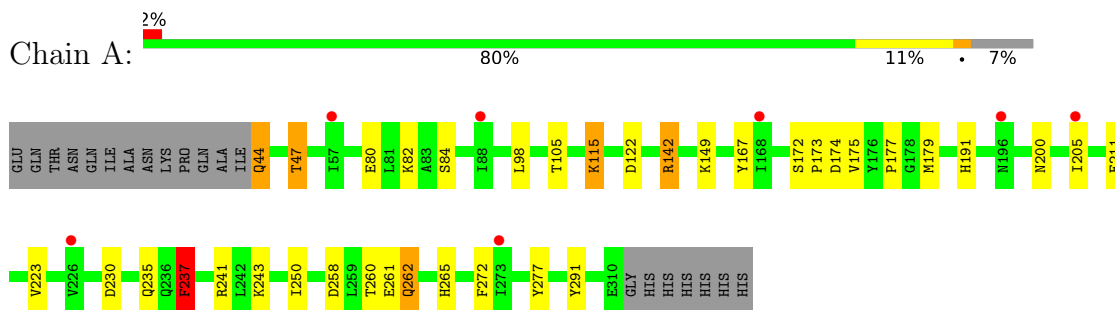

- Molecule 1: Glycerophosphoryl diester phosphodiesterase

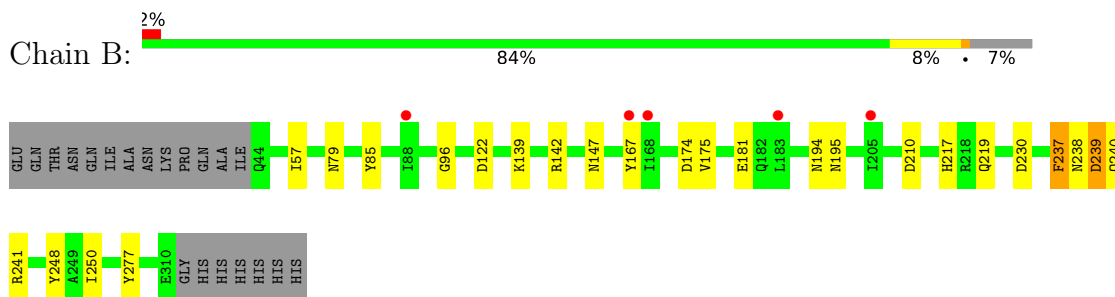

- Molecule 1: Glycerophosphoryl diester phosphodiesterase

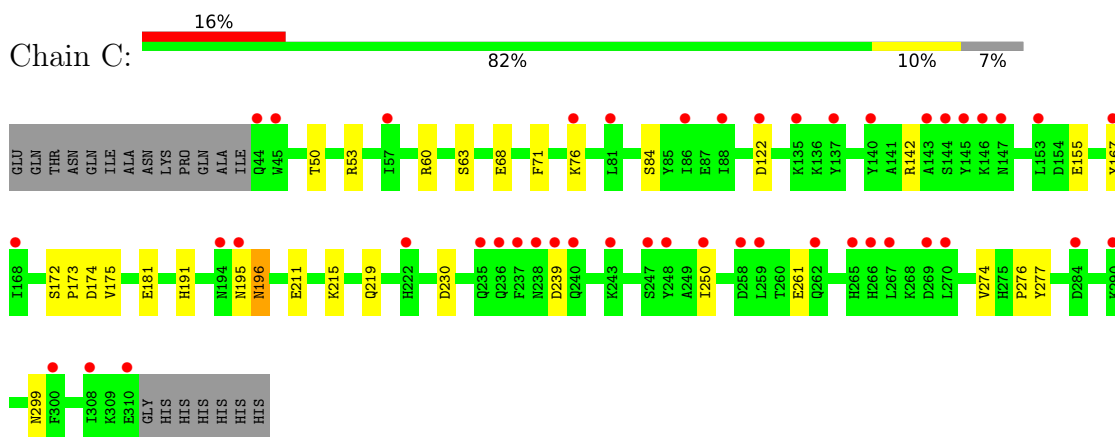

- Molecule 1: Glycerophosphoryl diester phosphodiesterase

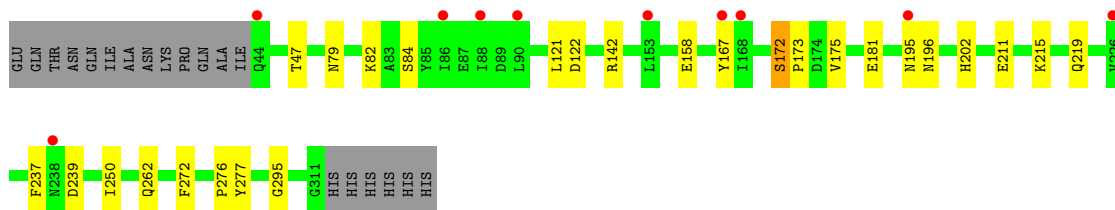
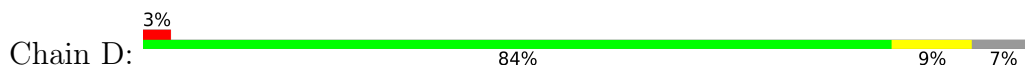

• Molecule 1: Glycerophosphoryl diester phosphodiesterase

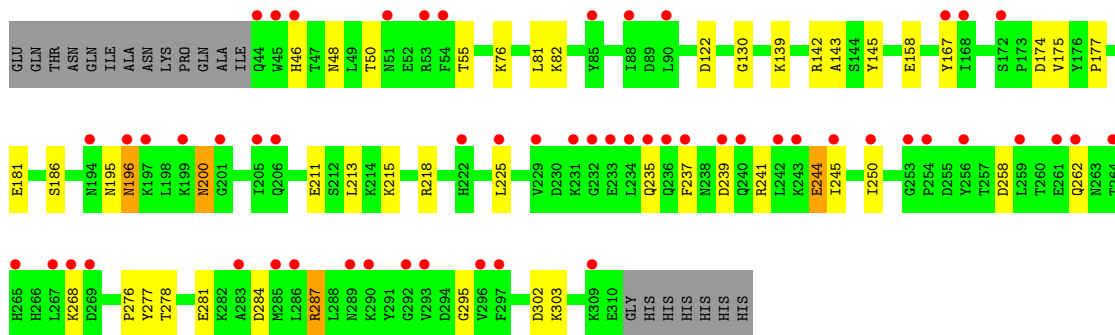
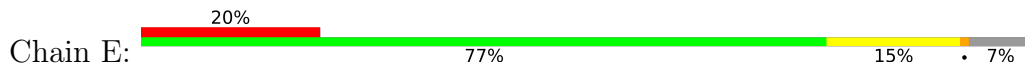

• Molecule 1: Glycerophosphoryl diester phosphodiesterase

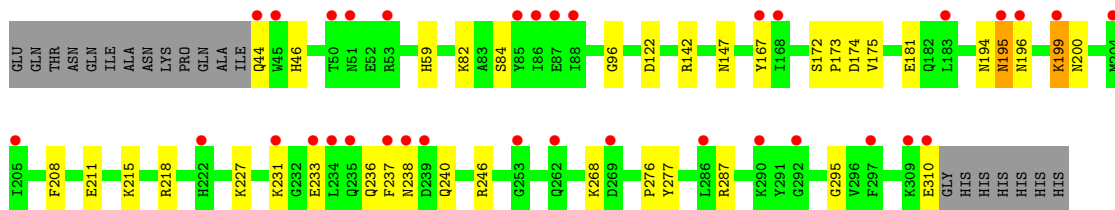
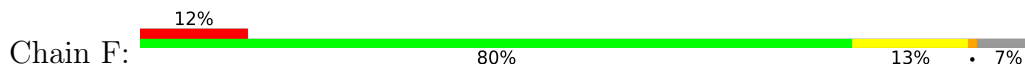

4 Data and refinement statistics

Property	Value	Source
Space group	C 2 2 1	Depositor
Cell constants a, b, c, α , β , γ	156.31Å 183.55Å 176.79Å 90.00° 90.00° 90.00°	Depositor
Resolution (Å)	20.00 – 2.20 35.23 – 2.20	Depositor EDS
% Data completeness (in resolution range)	97.2 (20.00-2.20) 97.1 (35.23-2.20)	Depositor EDS
R_{merge}	0.06	Depositor
R_{sym}	0.05	Depositor
$\langle I/\sigma(I) \rangle$ ¹	1.95 (at 2.20Å)	Xtrriage
Refinement program	REFMAC 5.2.0019	Depositor
R, R_{free}	0.235 , 0.280 0.231 , 0.277	Depositor DCC
R_{free} test set	3743 reflections (3.02%)	wwPDB-VP
Wilson B-factor (Å ²)	45.7	Xtrriage
Anisotropy	0.231	Xtrriage
Bulk solvent k_{sol} (e/Å ³), B_{sol} (Å ²)	0.33 , 58.2	EDS
L-test for twinning ²	$\langle L \rangle = 0.50$, $\langle L^2 \rangle = 0.33$	Xtrriage
Estimated twinning fraction	No twinning to report.	Xtrriage
F_o, F_c correlation	0.94	EDS
Total number of atoms	14474	wwPDB-VP
Average B, all atoms (Å ²)	56.0	wwPDB-VP

Xtrriage's analysis on translational NCS is as follows: *The analyses of the Patterson function reveals a significant off-origin peak that is 26.80 % of the origin peak, indicating pseudo-translational symmetry. The chance of finding a peak of this or larger height randomly in a structure without pseudo-translational symmetry is equal to 2.4673e-03. The detected translational NCS is most likely also responsible for the elevated intensity ratio.*

¹Intensities estimated from amplitudes.

²Theoretical values of $\langle |L| \rangle$, $\langle L^2 \rangle$ for acentric reflections are 0.5, 0.333 respectively for untwinned datasets, and 0.375, 0.2 for perfectly twinned datasets.

5 Model quality

5.1 Standard geometry

Bond lengths and bond angles in the following residue types are not validated in this section: ZN, GOL, SO4

The Z score for a bond length (or angle) is the number of standard deviations the observed value is removed from the expected value. A bond length (or angle) with $|Z| > 5$ is considered an outlier worth inspection. RMSZ is the root-mean-square of all Z scores of the bond lengths (or angles).

Mol	Chain	Bond lengths		Bond angles	
		RMSZ	# Z >5	RMSZ	# Z >5
1	A	0.50	0/2319	0.65	1/3128 (0.0%)
1	B	0.46	0/2311	0.62	0/3119
1	C	0.43	0/2282	0.56	0/3080
1	D	0.42	0/2293	0.57	0/3095
1	E	0.43	0/2260	0.58	0/3052
1	F	0.40	0/2263	0.58	1/3055 (0.0%)
All	All	0.44	0/13728	0.59	2/18529 (0.0%)

Chiral center outliers are detected by calculating the chiral volume of a chiral center and verifying if the center is modelled as a planar moiety or with the opposite hand. A planarity outlier is detected by checking planarity of atoms in a peptide group, atoms in a mainchain group or atoms of a sidechain that are expected to be planar.

Mol	Chain	#Chirality outliers	#Planarity outliers
1	A	1	2
1	B	0	1
1	C	0	1
1	D	0	2
1	E	0	1
1	F	1	3
All	All	2	10

There are no bond length outliers.

All (2) bond angle outliers are listed below:

Mol	Chain	Res	Type	Atoms	Z	Observed(°)	Ideal(°)
1	A	237	PHE	N-CA-C	6.03	127.27	111.00
1	F	240	GLN	N-CA-C	5.70	126.38	111.00

All (2) chirality outliers are listed below:

Mol	Chain	Res	Type	Atom
1	A	237	PHE	CA
1	F	240	GLN	CA

All (10) planarity outliers are listed below:

Mol	Chain	Res	Type	Group
1	A	272	PHE	Peptide
1	A	277	TYR	Peptide
1	B	277	TYR	Peptide
1	C	277	TYR	Peptide
1	D	272	PHE	Peptide
1	D	277	TYR	Peptide
1	E	277	TYR	Peptide
1	F	237	PHE	Peptide
1	F	238	ASN	Peptide
1	F	277	TYR	Peptide

5.2 Too-close contacts [i](#)

In the following table, the Non-H and H(model) columns list the number of non-hydrogen atoms and hydrogen atoms in the chain respectively. The H(added) column lists the number of hydrogen atoms added and optimized by MolProbity. The Clashes column lists the number of clashes within the asymmetric unit, whereas Symm-Clashes lists symmetry-related clashes.

Mol	Chain	Non-H	H(model)	H(added)	Clashes	Symm-Clashes
1	A	2238	0	2216	24	0
1	B	2233	0	2202	13	0
1	C	2216	0	2178	11	0
1	D	2223	0	2183	11	0
1	E	2200	0	2157	20	0
1	F	2203	0	2159	13	0
2	A	1	0	0	0	0
2	B	1	0	0	0	0
2	C	1	0	0	0	0
2	D	1	0	0	0	0
2	E	1	0	0	0	0
2	F	1	0	0	0	0
3	A	15	0	0	0	0
3	B	5	0	0	0	0
3	C	5	0	0	0	0
3	D	5	0	0	0	0
4	A	36	0	48	9	0

Continued on next page...

Continued from previous page...

Mol	Chain	Non-H	H(model)	H(added)	Clashes	Symm-Clashes
4	B	60	0	80	8	0
4	C	12	0	16	0	0
4	D	54	0	72	7	0
4	E	30	0	40	7	0
4	F	42	0	56	3	0
5	A	198	0	0	1	0
5	B	211	0	0	0	0
5	C	87	0	0	3	0
5	D	193	0	0	0	0
5	E	92	0	0	1	0
5	F	110	0	0	2	0
All	All	14474	0	13407	90	0

The all-atom clashscore is defined as the number of clashes found per 1000 atoms (including hydrogen atoms). The all-atom clashscore for this structure is 3.

All (90) close contacts within the same asymmetric unit are listed below, sorted by their clash magnitude.

Atom-1	Atom-2	Interatomic distance (Å)	Clash overlap (Å)
1:B:194:ASN:HB2	4:B:478:GOL:H11	1.02	0.99
1:B:194:ASN:HB2	4:B:478:GOL:C1	1.94	0.97
1:B:194:ASN:CB	4:B:478:GOL:H11	1.96	0.95
1:D:202:HIS:NE2	4:D:463:GOL:H32	1.90	0.86
1:D:79:ASN:O	1:D:82:LYS:HE2	1.81	0.79
1:B:239[A]:ASP:HB2	4:B:473:GOL:H2	1.66	0.77
4:A:476:GOL:H32	5:A:654:HOH:O	1.85	0.76
1:A:191:HIS:NE2	4:A:487:GOL:H32	2.07	0.68
1:E:215:LYS:HD3	4:E:467:GOL:H32	1.81	0.63
1:F:46:HIS:O	1:F:268:LYS:NZ	2.31	0.62
1:A:191:HIS:CD2	4:A:487:GOL:H32	2.35	0.62
1:F:195:ASN:O	1:F:199:LYS:HG2	2.01	0.61
1:F:173:PRO:HA	5:F:522:HOH:O	2.01	0.60
1:E:218:ARG:NH2	4:E:467:GOL:H2	2.18	0.59
1:F:194:ASN:HB2	4:F:460:GOL:O2	2.04	0.57
1:A:237:PHE:HB2	1:A:241:ARG:HG2	1.85	0.57
1:E:281:GLU:OE1	4:E:474:GOL:H2	2.06	0.56
1:D:181:GLU:HG3	1:D:219[B]:GLN:HE22	1.71	0.55
1:D:219[A]:GLN:NE2	4:D:481:GOL:H32	2.21	0.55
1:D:219[A]:GLN:HE21	4:D:481:GOL:H32	1.70	0.55
1:E:276:PRO:HD2	1:E:295:GLY:O	2.06	0.55
1:B:217:HIS:CE1	4:B:480:GOL:H32	2.42	0.55

Continued on next page...

Continued from previous page...

Atom-1	Atom-2	Interatomic distance (Å)	Clash overlap (Å)
1:A:47:THR:HG21	1:C:53[B]:ARG:HD3	1.89	0.55
1:C:191:HIS:ND1	5:C:514:HOH:O	2.34	0.54
1:E:46:HIS:O	1:E:268:LYS:NZ	2.40	0.54
1:D:202:HIS:CD2	4:D:463:GOL:H32	2.43	0.53
1:C:181:GLU:OE2	1:C:215:LYS:HE3	2.08	0.53
1:A:142:ARG:NH1	4:A:476:GOL:H2	2.23	0.52
1:B:238:ASN:HB3	4:B:472:GOL:H32	1.91	0.52
1:E:284:ASP:OD1	1:E:287:ARG:NH2	2.42	0.52
1:D:121:LEU:HD21	4:D:468:GOL:H11	1.90	0.52
1:E:181:GLU:HB3	1:F:181:GLU:HB3	1.92	0.52
1:E:241:ARG:O	1:E:241:ARG:HG3	2.11	0.51
1:E:48:ASN:HB3	5:E:558:HOH:O	2.12	0.50
1:C:181:GLU:HG3	1:C:219:GLN:HE22	1.77	0.50
1:E:81:LEU:HD22	1:E:302:ASP:HB3	1.94	0.49
1:E:303:LYS:HD3	4:E:474:GOL:H11	1.94	0.49
1:F:276:PRO:HD2	1:F:295:GLY:O	2.13	0.49
1:E:177:PRO:HB3	1:F:96:GLY:HA3	1.95	0.48
1:F:287:ARG:NH1	5:F:540:HOH:O	2.45	0.48
1:A:142:ARG:NH1	4:A:476:GOL:C3	2.77	0.48
1:A:191:HIS:NE2	4:A:487:GOL:C3	2.76	0.48
1:E:218:ARG:HD2	4:E:467:GOL:O1	2.13	0.48
1:B:210:ASP:OD1	1:B:248:TYR:OH	2.32	0.48
1:E:213:LEU:HD22	1:E:225:LEU:HB3	1.95	0.47
1:C:60:ARG:NH1	1:C:68:GLU:OE1	2.43	0.47
1:A:237:PHE:CB	1:A:241:ARG:HG2	2.45	0.47
1:A:172:SER:HA	1:A:173:PRO:HD3	1.61	0.47
1:E:130:GLY:HA3	1:E:145:TYR:O	2.14	0.47
1:A:142:ARG:HH11	4:A:476:GOL:C3	2.28	0.47
1:A:177:PRO:HB3	1:B:96:GLY:HA2	1.95	0.47
1:A:205:ILE:HD12	1:A:223:VAL:HG11	1.97	0.47
1:D:215:LYS:O	1:D:219[A]:GLN:HG3	2.15	0.46
1:B:237:PHE:HB2	1:B:241:ARG:HG2	1.97	0.46
1:B:79:ASN:HD21	4:B:458:GOL:H31	1.80	0.46
1:C:71:PHE:HZ	1:C:155:GLU:HB3	1.81	0.45
1:D:202:HIS:NE2	4:D:463:GOL:C3	2.72	0.45
1:A:44:GLN:HE21	1:A:44:GLN:HB2	1.58	0.45
1:C:63:SER:OG	1:C:299:ASN:OD1	2.35	0.45
1:A:142:ARG:NH1	4:A:476:GOL:C2	2.80	0.45
1:A:235:GLN:HE22	1:A:258:ASP:HB3	1.82	0.44
1:A:105:THR:HA	1:A:115:LYS:HA	2.00	0.44
1:E:218:ARG:HH21	4:E:467:GOL:H2	1.82	0.44

Continued on next page...

Continued from previous page...

Atom-1	Atom-2	Interatomic distance (Å)	Clash overlap (Å)
1:A:260:THR:OG1	1:A:262:GLN:NE2	2.51	0.44
1:F:218:ARG:HH21	4:F:459:GOL:H31	1.83	0.44
1:C:274:VAL:HG12	1:C:276:PRO:HD3	2.00	0.43
1:B:57:ILE:HA	1:B:85:TYR:HB2	2.00	0.43
1:C:196[A]:ASN:HD22	1:C:196[A]:ASN:HA	1.63	0.43
1:F:215:LYS:HD3	4:F:459:GOL:H12	2.01	0.43
1:F:208:PHE:O	1:F:227:LYS:NZ	2.46	0.43
1:E:196:ASN:O	1:E:200:ASN:ND2	2.52	0.43
1:A:98:LEU:HD22	1:A:179:MET:HE2	2.01	0.43
1:A:265:HIS:CE1	1:A:291:TYR:O	2.72	0.43
1:F:172:SER:HA	1:F:173:PRO:HD3	1.85	0.43
1:A:142:ARG:NH1	4:A:476:GOL:H32	2.34	0.43
1:C:172:SER:HA	1:C:173:PRO:HD3	1.90	0.43
1:E:235:GLN:HE22	1:E:258:ASP:HB3	1.84	0.42
1:A:261:GLU:O	1:A:265:HIS:ND1	2.52	0.42
5:C:548:HOH:O	4:D:481:GOL:H31	2.19	0.42
1:C:76:LYS:NZ	5:C:529:HOH:O	2.52	0.42
1:D:172:SER:HA	1:D:173:PRO:HD3	1.91	0.42
1:E:143:ALA:H	4:E:485:GOL:H11	1.83	0.42
1:D:276:PRO:HD2	1:D:295:GLY:O	2.20	0.41
1:A:149[B]:LYS:HA	1:A:149[B]:LYS:HD3	1.77	0.41
1:A:262:GLN:H	1:A:262:GLN:HG3	1.37	0.41
1:E:244[A]:GLU:CG	1:E:245:ILE:N	2.84	0.41
1:B:238:ASN:HB2	4:B:473:GOL:H12	2.02	0.41
1:A:250:ILE:O	1:A:250:ILE:HG13	2.21	0.40
1:B:181:GLU:HG3	1:B:219[B]:GLN:HE22	1.87	0.40
1:F:246:ARG:HA	1:F:246:ARG:HD2	1.97	0.40

There are no symmetry-related clashes.

5.3 Torsion angles [i](#)

5.3.1 Protein backbone [i](#)

In the following table, the Percentiles column shows the percent Ramachandran outliers of the chain as a percentile score with respect to all X-ray entries followed by that with respect to entries of similar resolution.

The Analysed column shows the number of residues for which the backbone conformation was analysed, and the total number of residues.

Mol	Chain	Analysed	Favoured	Allowed	Outliers	Percentiles	
1	A	275/287 (96%)	267 (97%)	8 (3%)	0	100	100
1	B	274/287 (96%)	268 (98%)	4 (2%)	2 (1%)	22	22
1	C	270/287 (94%)	263 (97%)	7 (3%)	0	100	100
1	D	272/287 (95%)	265 (97%)	7 (3%)	0	100	100
1	E	268/287 (93%)	259 (97%)	9 (3%)	0	100	100
1	F	268/287 (93%)	260 (97%)	7 (3%)	1 (0%)	34	37
All	All	1627/1722 (94%)	1582 (97%)	42 (3%)	3 (0%)	51	55

All (3) Ramachandran outliers are listed below:

Mol	Chain	Res	Type
1	B	147[A]	ASN
1	B	147[B]	ASN
1	F	59	HIS

5.3.2 Protein sidechains [i](#)

In the following table, the Percentiles column shows the percent sidechain outliers of the chain as a percentile score with respect to all X-ray entries followed by that with respect to entries of similar resolution.

The Analysed column shows the number of residues for which the sidechain conformation was analysed, and the total number of residues.

Mol	Chain	Analysed	Rotameric	Outliers	Percentiles	
1	A	247/254 (97%)	229 (93%)	18 (7%)	14	15
1	B	246/254 (97%)	231 (94%)	15 (6%)	18	21
1	C	242/254 (95%)	227 (94%)	15 (6%)	18	21
1	D	243/254 (96%)	228 (94%)	15 (6%)	18	21
1	E	240/254 (94%)	216 (90%)	24 (10%)	7	7
1	F	240/254 (94%)	221 (92%)	19 (8%)	12	12
All	All	1458/1524 (96%)	1352 (93%)	106 (7%)	15	15

All (106) residues with a non-rotameric sidechain are listed below:

Mol	Chain	Res	Type
1	A	44	GLN
1	A	47	THR

Continued on next page...

Continued from previous page...

Mol	Chain	Res	Type
1	A	80	GLU
1	A	82	LYS
1	A	84	SER
1	A	115	LYS
1	A	122	ASP
1	A	142	ARG
1	A	167	TYR
1	A	174	ASP
1	A	175	VAL
1	A	200[A]	ASN
1	A	200[B]	ASN
1	A	211	GLU
1	A	230	ASP
1	A	237	PHE
1	A	243	LYS
1	A	262	GLN
1	B	122	ASP
1	B	139[A]	LYS
1	B	139[B]	LYS
1	B	142	ARG
1	B	167	TYR
1	B	174[A]	ASP
1	B	174[B]	ASP
1	B	175	VAL
1	B	195	ASN
1	B	230	ASP
1	B	237	PHE
1	B	239[A]	ASP
1	B	239[B]	ASP
1	B	240	GLN
1	B	250	ILE
1	C	50	THR
1	C	84	SER
1	C	122	ASP
1	C	142	ARG
1	C	167	TYR
1	C	174	ASP
1	C	175	VAL
1	C	195	ASN
1	C	196[A]	ASN
1	C	196[B]	ASN
1	C	211	GLU

Continued on next page...

Continued from previous page...

Mol	Chain	Res	Type
1	C	230	ASP
1	C	239	ASP
1	C	250	ILE
1	C	261	GLU
1	D	47	THR
1	D	84	SER
1	D	122	ASP
1	D	142	ARG
1	D	158	GLU
1	D	167	TYR
1	D	172	SER
1	D	175	VAL
1	D	195	ASN
1	D	196	ASN
1	D	211	GLU
1	D	237	PHE
1	D	239	ASP
1	D	250	ILE
1	D	262	GLN
1	E	50	THR
1	E	55	THR
1	E	76	LYS
1	E	82	LYS
1	E	122	ASP
1	E	139	LYS
1	E	142	ARG
1	E	158	GLU
1	E	167	TYR
1	E	174	ASP
1	E	175	VAL
1	E	186	SER
1	E	195	ASN
1	E	196	ASN
1	E	200	ASN
1	E	211	GLU
1	E	237	PHE
1	E	239	ASP
1	E	244[A]	GLU
1	E	244[B]	GLU
1	E	250	ILE
1	E	262	GLN
1	E	278	THR

Continued on next page...

Continued from previous page...

Mol	Chain	Res	Type
1	E	287	ARG
1	F	44	GLN
1	F	82	LYS
1	F	84	SER
1	F	122	ASP
1	F	142	ARG
1	F	147	ASN
1	F	167	TYR
1	F	174	ASP
1	F	175	VAL
1	F	195	ASN
1	F	196	ASN
1	F	199	LYS
1	F	200	ASN
1	F	211	GLU
1	F	231	LYS
1	F	233[A]	GLU
1	F	233[B]	GLU
1	F	236	GLN
1	F	310	GLU

Sometimes sidechains can be flipped to improve hydrogen bonding and reduce clashes. All (26) such sidechains are listed below:

Mol	Chain	Res	Type
1	A	44	GLN
1	A	79	ASN
1	A	195	ASN
1	A	262	GLN
1	A	289	ASN
1	B	113	HIS
1	B	194	ASN
1	B	289	ASN
1	C	79	ASN
1	C	91	GLN
1	C	194	ASN
1	C	219	GLN
1	C	240	GLN
1	C	289	ASN
1	D	79	ASN
1	D	194	ASN
1	D	289	ASN
1	E	79	ASN

Continued on next page...

Continued from previous page...

Mol	Chain	Res	Type
1	E	102	HIS
1	E	200	ASN
1	E	235	GLN
1	E	289	ASN
1	F	195	ASN
1	F	200	ASN
1	F	262	GLN
1	F	289	ASN

5.3.3 RNA [i](#)

There are no RNA molecules in this entry.

5.4 Non-standard residues in protein, DNA, RNA chains [i](#)

There are no non-standard protein/DNA/RNA residues in this entry.

5.5 Carbohydrates [i](#)

There are no monosaccharides in this entry.

5.6 Ligand geometry [i](#)

Of 51 ligands modelled in this entry, 6 are monoatomic - leaving 45 for Mogul analysis.

In the following table, the Counts columns list the number of bonds (or angles) for which Mogul statistics could be retrieved, the number of bonds (or angles) that are observed in the model and the number of bonds (or angles) that are defined in the Chemical Component Dictionary. The Link column lists molecule types, if any, to which the group is linked. The Z score for a bond length (or angle) is the number of standard deviations the observed value is removed from the expected value. A bond length (or angle) with $|Z| > 2$ is considered an outlier worth inspection. RMSZ is the root-mean-square of all Z scores of the bond lengths (or angles).

Mol	Type	Chain	Res	Link	Bond lengths			Bond angles		
					Counts	RMSZ	$\# Z > 2$	Counts	RMSZ	$\# Z > 2$
4	GOL	F	457	-	5,5,5	0.39	0	5,5,5	0.35	0
4	GOL	B	461	-	5,5,5	0.41	0	5,5,5	0.51	0
4	GOL	D	481	-	5,5,5	0.68	0	5,5,5	0.88	0
4	GOL	A	487	-	5,5,5	0.64	0	5,5,5	0.33	0
4	GOL	D	471	-	5,5,5	0.35	0	5,5,5	0.37	0
4	GOL	C	482	-	5,5,5	0.50	0	5,5,5	0.29	0

Mol	Type	Chain	Res	Link	Bond lengths			Bond angles		
					Counts	RMSZ	# Z > 2	Counts	RMSZ	# Z > 2
4	GOL	F	464	-	5,5,5	0.35	0	5,5,5	0.35	0
4	GOL	D	463	-	5,5,5	0.36	0	5,5,5	0.28	0
3	SO4	A	442	-	4,4,4	0.16	0	6,6,6	0.08	0
4	GOL	F	459	-	5,5,5	0.36	0	5,5,5	0.28	0
3	SO4	A	445	-	4,4,4	0.13	0	6,6,6	0.09	0
4	GOL	A	475	-	5,5,5	0.37	0	5,5,5	0.28	0
4	GOL	F	456	2	5,5,5	0.42	0	5,5,5	0.39	0
4	GOL	A	476	-	5,5,5	0.58	0	5,5,5	0.21	0
4	GOL	D	462	-	5,5,5	0.42	0	5,5,5	0.21	0
4	GOL	F	488	-	5,5,5	0.38	0	5,5,5	0.30	0
4	GOL	B	472	-	5,5,5	0.37	0	5,5,5	0.18	0
4	GOL	B	469	-	5,5,5	0.37	0	5,5,5	0.28	0
4	GOL	D	453	2	5,5,5	0.34	0	5,5,5	0.33	0
4	GOL	D	466	-	5,5,5	0.36	0	5,5,5	0.23	0
4	GOL	E	467	-	5,5,5	0.37	0	5,5,5	0.28	0
3	SO4	A	441	-	4,4,4	0.16	0	6,6,6	0.09	0
4	GOL	F	486	-	5,5,5	0.34	0	5,5,5	0.27	0
4	GOL	B	477	-	5,5,5	0.45	0	5,5,5	0.28	0
4	GOL	E	454	2	5,5,5	0.33	0	5,5,5	0.35	0
4	GOL	F	460	-	5,5,5	0.35	0	5,5,5	0.30	0
4	GOL	A	489	-	5,5,5	0.35	0	5,5,5	0.33	0
4	GOL	E	465	-	5,5,5	0.36	0	5,5,5	0.26	0
4	GOL	E	485	-	5,5,5	0.30	0	5,5,5	0.42	0
4	GOL	B	458	-	5,5,5	0.42	0	5,5,5	0.57	0
4	GOL	C	451	2	5,5,5	0.37	0	5,5,5	0.37	0
3	SO4	D	444	-	4,4,4	0.14	0	6,6,6	0.10	0
4	GOL	B	480	-	5,5,5	0.82	0	5,5,5	0.93	0
4	GOL	E	474	-	5,5,5	0.37	0	5,5,5	0.24	0
4	GOL	B	452	2	5,5,5	0.26	0	5,5,5	0.49	0
4	GOL	A	455	2	5,5,5	0.26	0	5,5,5	0.47	0
4	GOL	B	478	-	5,5,5	0.37	0	5,5,5	0.28	0
3	SO4	C	446	-	4,4,4	0.14	0	6,6,6	0.09	0
4	GOL	B	479	-	5,5,5	0.35	0	5,5,5	0.40	0
3	SO4	B	443	-	4,4,4	0.15	0	6,6,6	0.14	0
4	GOL	A	470	-	5,5,5	0.33	0	5,5,5	0.39	0
4	GOL	D	484	-	5,5,5	0.36	0	5,5,5	0.35	0
4	GOL	D	468	-	5,5,5	0.38	0	5,5,5	0.32	0
4	GOL	D	483	-	5,5,5	0.36	0	5,5,5	0.28	0
4	GOL	B	473	-	5,5,5	0.49	0	5,5,5	0.37	0

In the following table, the Chirals column lists the number of chiral outliers, the number of chiral centers analysed, the number of these observed in the model and the number defined in the Chemical Component Dictionary. Similar counts are reported in the Torsion and Rings columns.

'-' means no outliers of that kind were identified.

Mol	Type	Chain	Res	Link	Chirals	Torsions	Rings
4	GOL	F	457	-	-	0/4/4/4	-
4	GOL	B	461	-	-	4/4/4/4	-
4	GOL	D	481	-	-	4/4/4/4	-
4	GOL	A	487	-	-	2/4/4/4	-
4	GOL	D	471	-	-	2/4/4/4	-
4	GOL	C	482	-	-	4/4/4/4	-
4	GOL	F	464	-	-	2/4/4/4	-
4	GOL	D	463	-	-	4/4/4/4	-
4	GOL	F	459	-	-	3/4/4/4	-
4	GOL	A	475	-	-	2/4/4/4	-
4	GOL	F	456	2	-	4/4/4/4	-
4	GOL	A	476	-	-	2/4/4/4	-
4	GOL	D	462	-	-	2/4/4/4	-
4	GOL	F	488	-	-	2/4/4/4	-
4	GOL	B	472	-	-	4/4/4/4	-
4	GOL	B	469	-	-	3/4/4/4	-
4	GOL	D	453	2	-	0/4/4/4	-
4	GOL	D	466	-	-	2/4/4/4	-
4	GOL	E	467	-	-	4/4/4/4	-
4	GOL	F	486	-	-	4/4/4/4	-
4	GOL	B	477	-	-	2/4/4/4	-
4	GOL	E	454	2	-	4/4/4/4	-
4	GOL	F	460	-	-	4/4/4/4	-
4	GOL	A	489	-	-	2/4/4/4	-
4	GOL	E	465	-	-	2/4/4/4	-
4	GOL	B	458	-	-	4/4/4/4	-
4	GOL	C	451	2	-	2/4/4/4	-
4	GOL	B	480	-	-	4/4/4/4	-
4	GOL	E	474	-	-	2/4/4/4	-
4	GOL	B	452	2	-	0/4/4/4	-
4	GOL	A	455	2	-	0/4/4/4	-
4	GOL	B	478	-	-	4/4/4/4	-
4	GOL	B	479	-	-	2/4/4/4	-
4	GOL	D	484	-	-	2/4/4/4	-
4	GOL	A	470	-	-	4/4/4/4	-

Continued on next page...

Continued from previous page...

Mol	Type	Chain	Res	Link	Chirals	Torsions	Rings
4	GOL	E	485	-	-	3/4/4/4	-
4	GOL	D	468	-	-	0/4/4/4	-
4	GOL	D	483	-	-	0/4/4/4	-
4	GOL	B	473	-	-	2/4/4/4	-

There are no bond length outliers.

There are no bond angle outliers.

There are no chirality outliers.

All (97) torsion outliers are listed below:

Mol	Chain	Res	Type	Atoms
4	A	470	GOL	O1-C1-C2-C3
4	A	470	GOL	C1-C2-C3-O3
4	A	470	GOL	O2-C2-C3-O3
4	A	489	GOL	O1-C1-C2-C3
4	A	476	GOL	O1-C1-C2-C3
4	B	458	GOL	C1-C2-C3-O3
4	B	461	GOL	O1-C1-C2-C3
4	B	461	GOL	C1-C2-C3-O3
4	B	469	GOL	O1-C1-C2-C3
4	B	472	GOL	O1-C1-C2-C3
4	B	472	GOL	C1-C2-C3-O3
4	B	477	GOL	O1-C1-C2-C3
4	B	478	GOL	O1-C1-C2-C3
4	B	478	GOL	C1-C2-C3-O3
4	B	480	GOL	C1-C2-C3-O3
4	C	451	GOL	O1-C1-C2-C3
4	C	482	GOL	O1-C1-C2-O2
4	C	482	GOL	O1-C1-C2-C3
4	C	482	GOL	O2-C2-C3-O3
4	D	462	GOL	O1-C1-C2-C3
4	D	463	GOL	O1-C1-C2-C3
4	D	466	GOL	C1-C2-C3-O3
4	D	481	GOL	C1-C2-C3-O3
4	E	454	GOL	O1-C1-C2-C3
4	E	454	GOL	C1-C2-C3-O3
4	E	465	GOL	O1-C1-C2-O2
4	E	465	GOL	O1-C1-C2-C3
4	E	467	GOL	O1-C1-C2-C3
4	E	467	GOL	C1-C2-C3-O3

Continued on next page...

Continued from previous page...

Mol	Chain	Res	Type	Atoms
4	F	456	GOL	O1-C1-C2-C3
4	F	456	GOL	C1-C2-C3-O3
4	F	459	GOL	C1-C2-C3-O3
4	F	459	GOL	O2-C2-C3-O3
4	F	460	GOL	O1-C1-C2-O2
4	F	460	GOL	C1-C2-C3-O3
4	F	486	GOL	O1-C1-C2-C3
4	A	470	GOL	O1-C1-C2-O2
4	B	458	GOL	O1-C1-C2-O2
4	D	463	GOL	O2-C2-C3-O3
4	D	466	GOL	O2-C2-C3-O3
4	D	471	GOL	O1-C1-C2-O2
4	F	456	GOL	O1-C1-C2-O2
4	B	458	GOL	O1-C1-C2-C3
4	B	473	GOL	C1-C2-C3-O3
4	B	480	GOL	O1-C1-C2-C3
4	C	482	GOL	C1-C2-C3-O3
4	D	463	GOL	C1-C2-C3-O3
4	D	471	GOL	O1-C1-C2-C3
4	D	481	GOL	O1-C1-C2-C3
4	D	484	GOL	C1-C2-C3-O3
4	E	474	GOL	C1-C2-C3-O3
4	E	485	GOL	O1-C1-C2-C3
4	E	485	GOL	C1-C2-C3-O3
4	F	460	GOL	O1-C1-C2-C3
4	F	464	GOL	O1-C1-C2-C3
4	F	486	GOL	C1-C2-C3-O3
4	A	489	GOL	O1-C1-C2-O2
4	B	461	GOL	O2-C2-C3-O3
4	B	469	GOL	O1-C1-C2-O2
4	B	472	GOL	O1-C1-C2-O2
4	B	472	GOL	O2-C2-C3-O3
4	B	477	GOL	O1-C1-C2-O2
4	B	478	GOL	O1-C1-C2-O2
4	B	478	GOL	O2-C2-C3-O3
4	B	480	GOL	O1-C1-C2-O2
4	D	481	GOL	O2-C2-C3-O3
4	E	454	GOL	O1-C1-C2-O2
4	E	467	GOL	O2-C2-C3-O3
4	E	485	GOL	O1-C1-C2-O2
4	F	460	GOL	O2-C2-C3-O3
4	F	486	GOL	O1-C1-C2-O2

Continued on next page...

Continued from previous page...

Mol	Chain	Res	Type	Atoms
4	A	476	GOL	O1-C1-C2-O2
4	B	458	GOL	O2-C2-C3-O3
4	B	461	GOL	O1-C1-C2-O2
4	B	480	GOL	O2-C2-C3-O3
4	C	451	GOL	O1-C1-C2-O2
4	D	462	GOL	O1-C1-C2-O2
4	D	463	GOL	O1-C1-C2-O2
4	E	454	GOL	O2-C2-C3-O3
4	F	456	GOL	O2-C2-C3-O3
4	A	475	GOL	O2-C2-C3-O3
4	B	473	GOL	O2-C2-C3-O3
4	D	484	GOL	O2-C2-C3-O3
4	E	467	GOL	O1-C1-C2-O2
4	B	479	GOL	O1-C1-C2-O2
4	D	481	GOL	O1-C1-C2-O2
4	F	464	GOL	O1-C1-C2-O2
4	F	488	GOL	O2-C2-C3-O3
4	F	488	GOL	C1-C2-C3-O3
4	F	459	GOL	O1-C1-C2-C3
4	A	487	GOL	O1-C1-C2-O2
4	B	469	GOL	O2-C2-C3-O3
4	E	474	GOL	O2-C2-C3-O3
4	A	475	GOL	C1-C2-C3-O3
4	A	487	GOL	O1-C1-C2-C3
4	B	479	GOL	O1-C1-C2-C3
4	F	486	GOL	O2-C2-C3-O3

There are no ring outliers.

15 monomers are involved in 34 short contacts:

Mol	Chain	Res	Type	Clashes	Symm-Clashes
4	D	481	GOL	3	0
4	A	487	GOL	3	0
4	D	463	GOL	3	0
4	F	459	GOL	2	0
4	A	476	GOL	6	0
4	B	472	GOL	1	0
4	E	467	GOL	4	0
4	F	460	GOL	1	0
4	E	485	GOL	1	0
4	B	458	GOL	1	0
4	B	480	GOL	1	0

Continued on next page...

Continued from previous page...

Mol	Chain	Res	Type	Clashes	Symm-Clashes
4	E	474	GOL	2	0
4	B	478	GOL	3	0
4	D	468	GOL	1	0
4	B	473	GOL	2	0

5.7 Other polymers [i](#)

There are no such residues in this entry.

5.8 Polymer linkage issues [i](#)

There are no chain breaks in this entry.

6 Fit of model and data [i](#)

6.1 Protein, DNA and RNA chains [i](#)

In the following table, the column labelled ‘#RSRZ > 2’ contains the number (and percentage) of RSRZ outliers, followed by percent RSRZ outliers for the chain as percentile scores relative to all X-ray entries and entries of similar resolution. The OWAB column contains the minimum, median, 95th percentile and maximum values of the occupancy-weighted average B-factor per residue. The column labelled ‘Q < 0.9’ lists the number of (and percentage) of residues with an average occupancy less than 0.9.

Mol	Chain	Analysed	<RSRZ>	#RSRZ>2	OWAB(Å ²)	Q<0.9
1	A	267/287 (93%)	-0.11	7 (2%) 56 53	29, 43, 73, 125	0
1	B	267/287 (93%)	-0.19	5 (1%) 66 65	25, 37, 65, 113	0
1	C	267/287 (93%)	0.83	45 (16%) 1 1	42, 64, 99, 151	0
1	D	268/287 (93%)	0.01	10 (3%) 41 39	29, 46, 77, 124	0
1	E	267/287 (93%)	0.89	56 (20%) 1 1	36, 66, 100, 145	0
1	F	267/287 (93%)	0.55	34 (12%) 3 3	35, 56, 86, 135	0
All	All	1603/1722 (93%)	0.33	157 (9%) 7 6	25, 52, 92, 151	0

All (157) RSRZ outliers are listed below:

Mol	Chain	Res	Type	RSRZ
1	E	242	LEU	7.8
1	E	45	TRP	7.4
1	F	239	ASP	7.1
1	C	236	GLN	6.6
1	E	239	ASP	6.6
1	E	54	PHE	6.5
1	F	45	TRP	6.0
1	E	286	LEU	5.9
1	E	235	GLN	5.6
1	E	237	PHE	5.2
1	E	269	ASP	5.0
1	C	247	SER	4.9
1	E	262	GLN	4.6
1	E	167	TYR	4.5
1	C	270	LEU	4.5
1	E	265	HIS	4.4
1	E	256	TYR	4.4
1	C	45	TRP	4.4
1	D	168	ILE	4.3

Continued on next page...

Continued from previous page...

Mol	Chain	Res	Type	RSRZ
1	E	231	LYS	4.2
1	C	239	ASP	4.2
1	C	266	HIS	4.2
1	C	240	GLN	4.2
1	F	269	ASP	4.2
1	C	308	ILE	4.1
1	B	168	ILE	4.0
1	E	168	ILE	3.9
1	F	167	TYR	3.9
1	A	196	ASN	3.9
1	C	146	LYS	3.8
1	C	300	PHE	3.8
1	E	232	GLY	3.7
1	D	88	ILE	3.7
1	E	264	THR	3.7
1	E	290	LYS	3.6
1	C	243	LYS	3.6
1	F	235	GLN	3.6
1	F	168	ILE	3.5
1	C	238	ASN	3.5
1	F	51	ASN	3.4
1	D	238	ASN	3.4
1	F	309	LYS	3.4
1	E	88	ILE	3.4
1	F	262	GLN	3.3
1	F	88	ILE	3.3
1	E	240	GLN	3.2
1	C	88	ILE	3.2
1	F	199	LYS	3.2
1	E	53	ARG	3.2
1	E	236	GLN	3.1
1	E	243	LYS	3.1
1	A	88	ILE	3.1
1	A	168	ILE	3.1
1	B	205	ILE	3.1
1	F	195	ASN	3.1
1	E	259	LEU	3.1
1	B	88	ILE	3.1
1	E	196	ASN	3.0
1	C	137	TYR	3.0
1	C	290	LYS	3.0
1	C	147	ASN	3.0

Continued on next page...

Continued from previous page...

Mol	Chain	Res	Type	RSRZ
1	F	290	LYS	3.0
1	E	292	GLY	3.0
1	F	237	PHE	3.0
1	F	183	LEU	2.9
1	E	44	GLN	2.9
1	F	292	GLY	2.9
1	C	135	LYS	2.9
1	E	229	VAL	2.9
1	E	222	HIS	2.9
1	C	237	PHE	2.9
1	E	172	SER	2.8
1	E	289	ASN	2.8
1	A	205	ILE	2.8
1	C	269	ASP	2.8
1	E	194	ASN	2.8
1	E	199	LYS	2.7
1	D	153	LEU	2.7
1	F	196	ASN	2.7
1	E	309	LYS	2.6
1	D	167	TYR	2.6
1	C	86	ILE	2.6
1	C	284	ASP	2.6
1	C	168	ILE	2.6
1	B	183	LEU	2.6
1	E	293	VAL	2.6
1	E	197	LYS	2.6
1	F	205	ILE	2.5
1	E	297	PHE	2.5
1	B	167	TYR	2.5
1	A	273	ILE	2.5
1	C	267	LEU	2.5
1	A	226	VAL	2.5
1	D	226	VAL	2.5
1	F	233[A]	GLU	2.5
1	E	234	LEU	2.5
1	C	250	ILE	2.4
1	F	85	TYR	2.4
1	C	259	LEU	2.4
1	C	143	ALA	2.4
1	C	265	HIS	2.4
1	F	204	MET	2.4
1	C	153	LEU	2.4

Continued on next page...

Continued from previous page...

Mol	Chain	Res	Type	RSRZ
1	F	231	LYS	2.4
1	D	44	GLN	2.4
1	C	140	TYR	2.4
1	E	268	LYS	2.3
1	F	222	HIS	2.3
1	E	51	ASN	2.3
1	F	87	GLU	2.3
1	E	205[A]	ILE	2.3
1	E	283	ALA	2.3
1	E	46	HIS	2.3
1	C	81	LEU	2.3
1	D	86	ILE	2.3
1	E	296	VAL	2.2
1	C	57	ILE	2.2
1	E	261	GLU	2.2
1	D	195	ASN	2.2
1	C	144	SER	2.2
1	F	253	GLY	2.2
1	C	195	ASN	2.2
1	E	201	GLY	2.2
1	F	50	THR	2.2
1	C	122	ASP	2.2
1	E	250	ILE	2.2
1	E	90	LEU	2.2
1	F	234	LEU	2.2
1	C	235	GLN	2.2
1	F	86	ILE	2.1
1	E	253	GLY	2.1
1	F	53	ARG	2.1
1	F	310	GLU	2.1
1	F	297	PHE	2.1
1	C	258	ASP	2.1
1	E	245	ILE	2.1
1	C	194	ASN	2.1
1	F	286	LEU	2.1
1	C	145	TYR	2.1
1	E	85	TYR	2.1
1	C	262	GLN	2.1
1	D	90	LEU	2.1
1	E	206	GLN	2.1
1	C	248	TYR	2.1
1	A	57	ILE	2.1

Continued on next page...

Continued from previous page...

Mol	Chain	Res	Type	RSRZ
1	F	238	ASN	2.1
1	C	76	LYS	2.1
1	C	310	GLU	2.0
1	F	44	GLN	2.0
1	E	225	LEU	2.0
1	E	285	MET	2.0
1	E	254	PRO	2.0
1	C	167	TYR	2.0
1	C	222	HIS	2.0
1	C	44	GLN	2.0
1	E	233	GLU	2.0
1	E	267	LEU	2.0

6.2 Non-standard residues in protein, DNA, RNA chains [i](#)

There are no non-standard protein/DNA/RNA residues in this entry.

6.3 Carbohydrates [i](#)

There are no monosaccharides in this entry.

6.4 Ligands [i](#)

In the following table, the Atoms column lists the number of modelled atoms in the group and the number defined in the chemical component dictionary. The B-factors column lists the minimum, median, 95th percentile and maximum values of B factors of atoms in the group. The column labelled 'Q< 0.9' lists the number of atoms with occupancy less than 0.9.

Mol	Type	Chain	Res	Atoms	RSCC	RSR	B-factors(Å ²)	Q<0.9
4	GOL	A	475	6/6	0.60	0.17	67,90,96,98	0
4	GOL	B	473	6/6	0.66	0.37	105,114,121,126	0
4	GOL	E	485	6/6	0.71	0.14	55,60,70,84	0
4	GOL	F	486	6/6	0.72	0.25	78,91,111,116	0
4	GOL	F	460	6/6	0.75	0.22	97,117,121,121	0
4	GOL	B	478	6/6	0.75	0.26	79,98,125,136	0
4	GOL	B	469	6/6	0.76	0.42	60,77,98,113	0
4	GOL	B	480	6/6	0.77	0.20	69,95,105,118	0
4	GOL	A	489	6/6	0.77	0.27	94,102,108,108	0
4	GOL	D	468	6/6	0.78	0.17	49,82,87,89	0
4	GOL	A	476	6/6	0.78	0.23	92,108,116,117	0

Continued on next page...

Continued from previous page...

Mol	Type	Chain	Res	Atoms	RSCC	RSR	B-factors(\AA^2)	Q<0.9
3	SO4	A	441	5/5	0.79	0.29	95,100,125,131	0
4	GOL	D	466	6/6	0.79	0.19	58,95,100,116	0
4	GOL	E	467	6/6	0.80	0.31	70,102,105,118	0
4	GOL	B	472	6/6	0.81	0.39	78,93,99,105	0
4	GOL	E	474	6/6	0.82	0.17	101,111,119,121	0
4	GOL	D	483	6/6	0.82	0.19	89,93,102,105	0
4	GOL	B	458	6/6	0.83	0.18	46,64,70,88	0
4	GOL	F	464	6/6	0.83	0.18	63,82,88,93	0
4	GOL	D	471	6/6	0.83	0.23	52,65,80,81	0
4	GOL	C	482	6/6	0.84	0.15	70,95,99,99	0
4	GOL	D	462	6/6	0.84	0.17	44,59,87,92	0
4	GOL	E	454	6/6	0.85	0.38	54,65,77,87	0
4	GOL	B	479	6/6	0.87	0.17	68,90,106,107	0
4	GOL	D	463	6/6	0.89	0.30	45,63,89,106	0
4	GOL	A	487	6/6	0.89	0.28	80,87,93,107	0
4	GOL	F	459	6/6	0.90	0.17	52,71,84,99	0
4	GOL	E	465	6/6	0.90	0.14	43,84,89,98	0
3	SO4	B	443	5/5	0.90	0.23	73,83,96,114	0
4	GOL	F	457	6/6	0.90	0.22	39,62,84,84	0
4	GOL	D	481	6/6	0.91	0.13	64,76,84,92	0
4	GOL	A	470	6/6	0.91	0.18	56,70,80,88	0
3	SO4	D	444	5/5	0.91	0.10	73,79,104,107	0
4	GOL	B	461	6/6	0.91	0.14	57,75,86,86	0
3	SO4	A	445	5/5	0.92	0.29	77,85,104,112	0
4	GOL	D	484	6/6	0.93	0.16	57,79,86,87	0
4	GOL	F	488	6/6	0.93	0.12	56,79,94,94	0
2	ZN	E	404	1/1	0.94	0.11	73,73,73,73	0
4	GOL	F	456	6/6	0.94	0.29	43,53,53,54	0
3	SO4	C	446	5/5	0.95	0.20	77,80,103,109	0
4	GOL	A	455	6/6	0.96	0.18	30,36,45,50	0
4	GOL	B	477	6/6	0.96	0.20	36,64,80,87	0
4	GOL	C	451	6/6	0.96	0.22	58,67,89,90	0
2	ZN	F	402	1/1	0.96	0.12	76,76,76,76	0
3	SO4	A	442	5/5	0.97	0.12	57,72,80,81	0
2	ZN	C	406	1/1	0.98	0.09	76,76,76,76	0
4	GOL	B	452	6/6	0.99	0.18	19,25,34,36	0
2	ZN	B	401	1/1	0.99	0.05	46,46,46,46	0
2	ZN	D	405	1/1	0.99	0.06	60,60,60,60	0
4	GOL	D	453	6/6	0.99	0.13	34,37,43,49	0
2	ZN	A	403	1/1	1.00	0.08	53,53,53,53	0

6.5 Other polymers [i](#)

There are no such residues in this entry.