



# wwPDB X-ray Structure Validation Summary Report

Aug 20, 2023 – 10:52 AM EDT

PDB ID : 2II3  
Title : Crystal structure of a cubic core of the dihydrolipoamide acyltransferase (E2b) component in the branched-chain alpha-ketoacid dehydrogenase complex (BCKDC), Oxidized Coenzyme A-bound form  
Authors : Kato, M.; Wynn, R.M.; Chuang, J.L.; Brautigam, C.A.; Custorio, M.; Chuang, D.T.  
Deposited on : 2006-09-27  
Resolution : 2.17 Å(reported)

This is a wwPDB X-ray Structure Validation Summary Report for a publicly released PDB entry.

We welcome your comments at [validation@mail.wwpdb.org](mailto:validation@mail.wwpdb.org)

A user guide is available at

<https://www.wwpdb.org/validation/2017/XrayValidationReportHelp>

with specific help available everywhere you see the  symbol.

The types of validation reports are described at

<http://www.wwpdb.org/validation/2017/FAQs#types>.

---

The following versions of software and data (see [references](#) ①) were used in the production of this report:

MolProbity : 4.02b-467  
Mogul : 1.8.5 (274361), CSD as541be (2020)  
Xtrriage (Phenix) : 1.13  
EDS : 2.35  
buster-report : 1.1.7 (2018)  
Percentile statistics : 20191225.v01 (using entries in the PDB archive December 25th 2019)  
Refmac : 5.8.0158  
CCP4 : 7.0.044 (Gargrove)  
Ideal geometry (proteins) : Engh & Huber (2001)  
Ideal geometry (DNA, RNA) : Parkinson et al. (1996)  
Validation Pipeline (wwPDB-VP) : 2.35

# 1 Overall quality at a glance

The following experimental techniques were used to determine the structure:

*X-RAY DIFFRACTION*

The reported resolution of this entry is 2.17 Å.

Percentile scores (ranging between 0-100) for global validation metrics of the entry are shown in the following graphic. The table shows the number of entries on which the scores are based.

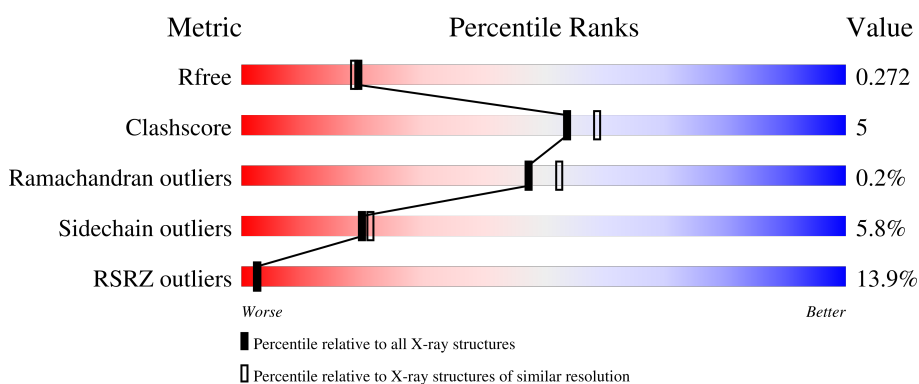



Metric	Whole archive (#Entries)	Similar resolution (#Entries, resolution range(Å))
$R_{free}$	130704	6864 (2.20-2.16)
Clashscore	141614	7689 (2.20-2.16)
Ramachandran outliers	138981	7564 (2.20-2.16)
Sidechain outliers	138945	7564 (2.20-2.16)
RSRZ outliers	127900	6738 (2.20-2.16)

The table below summarises the geometric issues observed across the polymeric chains and their fit to the electron density. The red, orange, yellow and green segments of the lower bar indicate the fraction of residues that contain outliers for  $\geq 3$ , 2, 1 and 0 types of geometric quality criteria respectively. A grey segment represents the fraction of residues that are not modelled. The numeric value for each fraction is indicated below the corresponding segment, with a dot representing fractions  $\leq 5\%$ . The upper red bar (where present) indicates the fraction of residues that have poor fit to the electron density. The numeric value is given above the bar.

Mol	Chain	Length	Quality of chain
1	A	262	 10% 73% 14% • 11%
1	B	262	 12% 77% 10% • 11%
1	C	262	 11% 75% 11% • 11%
1	D	262	 13% 77% 11% • 11%
1	E	262	 14% 79% 9% • 11%

*Continued on next page...*

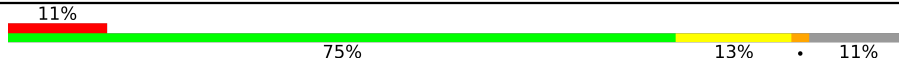
*Continued from previous page...*

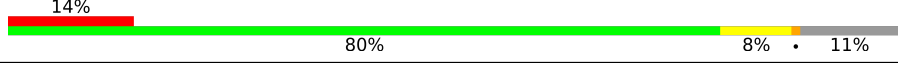
Mol	Chain	Length	Quality of chain
1	F	262	
1	G	262	
1	H	262	

The following table lists non-polymeric compounds, carbohydrate monomers and non-standard residues in protein, DNA, RNA chains that are outliers for geometric or electron-density-fit criteria:

Mol	Type	Chain	Res	Chirality	Geometry	Clashes	Electron density
2	ACT	E	600	-	-	X	-
2	ACT	H	602	-	-	X	-
4	CAO	B	500	X	-	-	-
4	CAO	F	500	X	-	-	-
4	CAO	H	500	X	-	-	-

## 2 Entry composition i

There are 5 unique types of molecules in this entry. The entry contains 15647 atoms, of which 0 are hydrogens and 0 are deuteriums.

In the tables below, the ZeroOcc column contains the number of atoms modelled with zero occupancy, the AltConf column contains the number of residues with at least one atom in alternate conformation and the Trace column contains the number of residues modelled with at most 2 atoms.

- Molecule 1 is a protein called Lipoamide acyltransferase component of branched-chain alpha-keto acid dehydrogenase complex.

Mol	Chain	Residues	Atoms					ZeroOcc	AltConf	Trace
1	A	234	Total	C	N	O	S	0	2	0
			1814	1164	308	332	10			
1	B	234	Total	C	N	O	S	0	2	0
			1814	1164	308	332	10			
1	C	234	Total	C	N	O	S	0	1	0
			1806	1160	306	330	10			
1	D	234	Total	C	N	O	S	0	0	0
			1803	1158	306	330	9			
1	E	234	Total	C	N	O	S	0	1	0
			1806	1160	306	330	10			
1	F	234	Total	C	N	O	S	0	1	0
			1806	1160	306	330	10			
1	G	234	Total	C	N	O	S	0	0	0
			1803	1158	306	330	9			
1	H	234	Total	C	N	O	S	0	2	0
			1814	1164	308	332	10			

There are 16 discrepancies between the modelled and reference sequences:

Chain	Residue	Modelled	Actual	Comment	Reference
A	160	GLY	-	cloning artifact	UNP P11181
A	161	HIS	-	cloning artifact	UNP P11181
B	160	GLY	-	cloning artifact	UNP P11181
B	161	HIS	-	cloning artifact	UNP P11181
C	160	GLY	-	cloning artifact	UNP P11181
C	161	HIS	-	cloning artifact	UNP P11181
D	160	GLY	-	cloning artifact	UNP P11181
D	161	HIS	-	cloning artifact	UNP P11181
E	160	GLY	-	cloning artifact	UNP P11181
E	161	HIS	-	cloning artifact	UNP P11181
F	160	GLY	-	cloning artifact	UNP P11181
F	161	HIS	-	cloning artifact	UNP P11181

*Continued on next page...*

Continued from previous page...

Chain	Residue	Modelled	Actual	Comment	Reference
G	160	GLY	-	cloning artifact	UNP P11181
G	161	HIS	-	cloning artifact	UNP P11181
H	160	GLY	-	cloning artifact	UNP P11181
H	161	HIS	-	cloning artifact	UNP P11181

- Molecule 2 is ACETATE ION (three-letter code: ACT) (formula: C<sub>2</sub>H<sub>3</sub>O<sub>2</sub>).

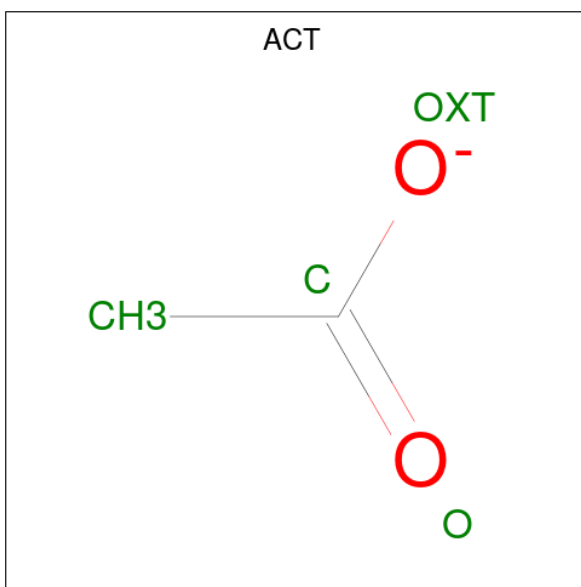

Mol	Chain	Residues	Atoms	ZeroOcc	AltConf
2	A	1	Total C O 4 2 2	0	0
2	B	1	Total C O 4 2 2	0	0
2	B	1	Total C O 4 2 2	0	0
2	B	1	Total C O 4 2 2	0	0
2	B	1	Total C O 4 2 2	0	0
2	C	1	Total C O 4 2 2	0	0
2	C	1	Total C O 4 2 2	0	0
2	C	1	Total C O 4 2 2	0	0
2	D	1	Total C O 4 2 2	0	0

Continued on next page...

*Continued from previous page...*

Mol	Chain	Residues	Atoms	ZeroOcc	AltConf
2	D	1	Total C O 4 2 2	0	0
2	D	1	Total C O 4 2 2	0	0
2	E	1	Total C O 4 2 2	0	0
2	E	1	Total C O 4 2 2	0	0
2	F	1	Total C O 4 2 2	0	0
2	F	1	Total C O 4 2 2	0	0
2	F	1	Total C O 4 2 2	0	0
2	G	1	Total C O 4 2 2	0	0
2	H	1	Total C O 4 2 2	0	0
2	H	1	Total C O 4 2 2	0	0
2	H	1	Total C O 4 2 2	0	0

- Molecule 3 is CHLORIDE ION (three-letter code: CL) (formula: Cl).

Mol	Chain	Residues	Atoms	ZeroOcc	AltConf
3	A	1	Total Cl 1 1	0	0
3	B	1	Total Cl 1 1	0	0
3	C	2	Total Cl 2 2	0	0
3	D	1	Total Cl 1 1	0	0
3	E	1	Total Cl 1 1	0	0
3	F	2	Total Cl 2 2	0	0
3	G	2	Total Cl 2 2	0	0
3	H	2	Total Cl 2 2	0	0

- Molecule 4 is OXIDIZED COENZYME A (three-letter code: CAO) (formula:  $C_{21}H_{36}N_7O_{17}P_3S$ ).

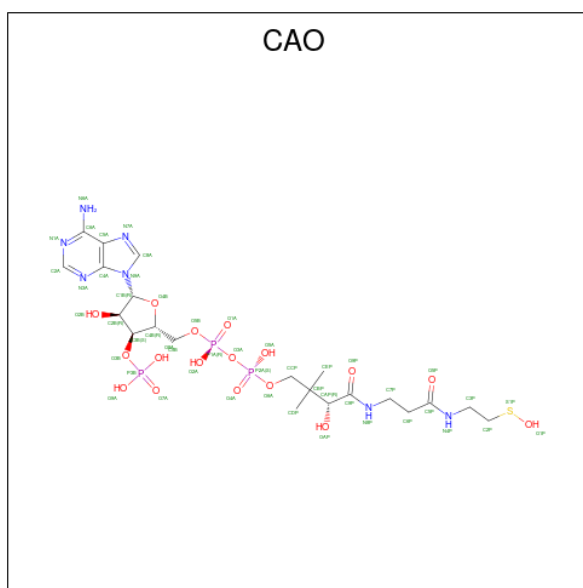

Mol	Chain	Residues	Atoms					ZeroOcc	AltConf	
			Total	C	N	O	P			S
4	A	1	49	21	7	17	3	1	0	0
4	B	1	40	16	6	15	3		0	0
4	C	1	40	16	6	15	3		0	0
4	D	1	40	16	6	15	3		0	0
4	E	1	49	21	7	17	3	1	0	0
4	F	1	40	16	6	15	3		0	0
4	G	1	49	21	7	17	3	1	0	0
4	H	1	40	16	6	15	3		0	0

- Molecule 5 is water.

Mol	Chain	Residues	Atoms		ZeroOcc	AltConf
5	A	95	Total	O	0	0
			95	95		
5	B	102	Total	O	0	0
			102	102		
5	C	71	Total	O	0	0
			71	71		

*Continued on next page...*



*Continued from previous page...*

<b>Mol</b>	<b>Chain</b>	<b>Residues</b>	<b>Atoms</b>		<b>ZeroOcc</b>	<b>AltConf</b>
5	D	110	Total 110	O 110	0	0
5	E	93	Total 93	O 93	0	0
5	F	105	Total 105	O 105	0	0
5	G	68	Total 68	O 68	0	0
5	H	98	Total 98	O 98	0	0

### 3 Residue-property plots [i](#)

These plots are drawn for all protein, RNA, DNA and oligosaccharide chains in the entry. The first graphic for a chain summarises the proportions of the various outlier classes displayed in the second graphic. The second graphic shows the sequence view annotated by issues in geometry and electron density. Residues are color-coded according to the number of geometric quality criteria for which they contain at least one outlier: green = 0, yellow = 1, orange = 2 and red = 3 or more. A red dot above a residue indicates a poor fit to the electron density ( $RSRZ > 2$ ). Stretches of 2 or more consecutive residues without any outlier are shown as a green connector. Residues present in the sample, but not in the model, are shown in grey.

- Molecule 1: Lipoamide acyltransferase component of branched-chain alpha-keto acid dehydrogenase complex

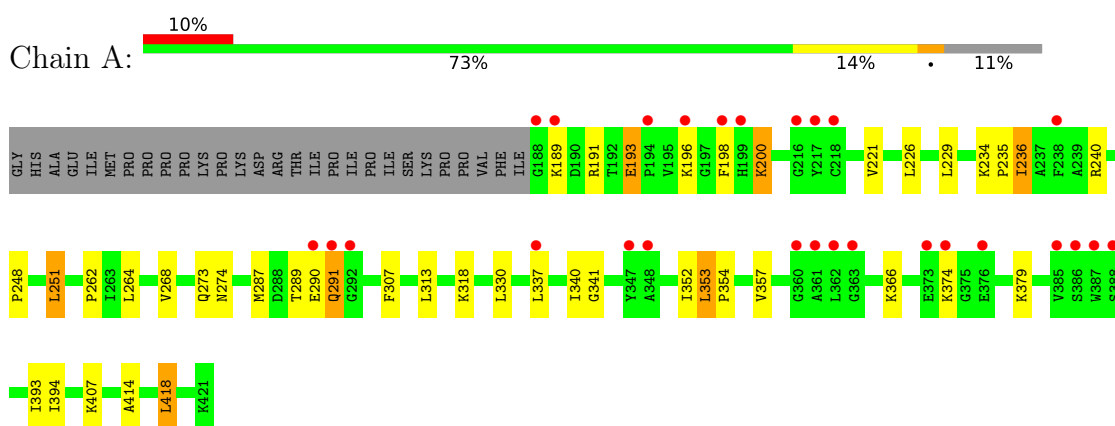

- Molecule 1: Lipoamide acyltransferase component of branched-chain alpha-keto acid dehydrogenase complex

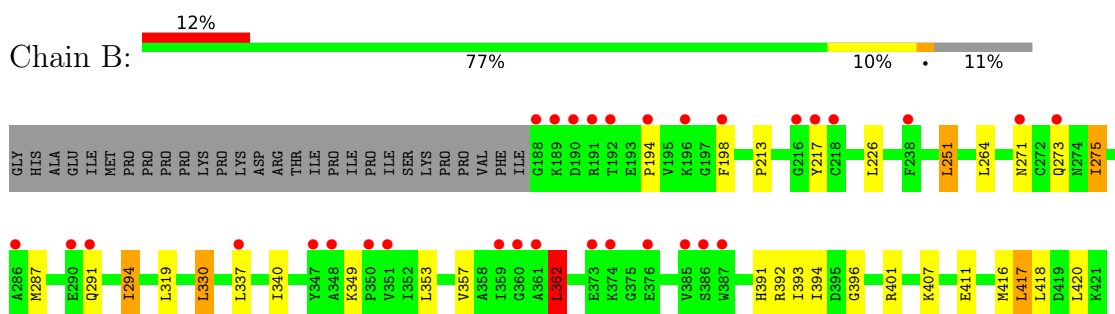

- Molecule 1: Lipoamide acyltransferase component of branched-chain alpha-keto acid dehydrogenase complex

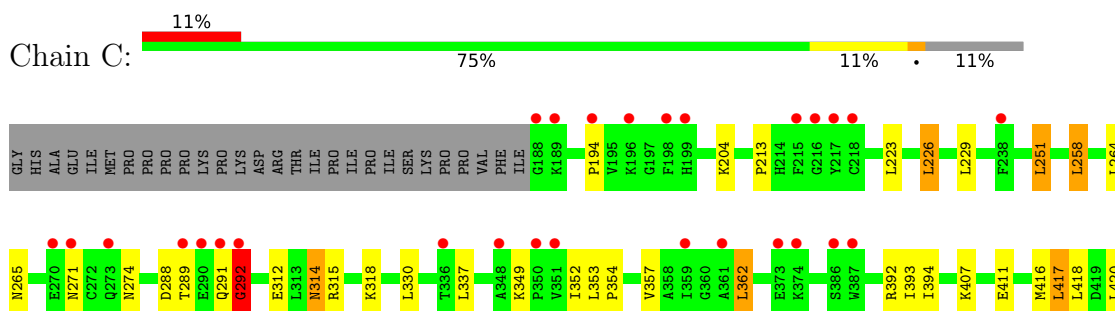

K421

- Molecule 1: Lipoamide acyltransferase component of branched-chain alpha-keto acid dehydrogenase complex

Chain D:

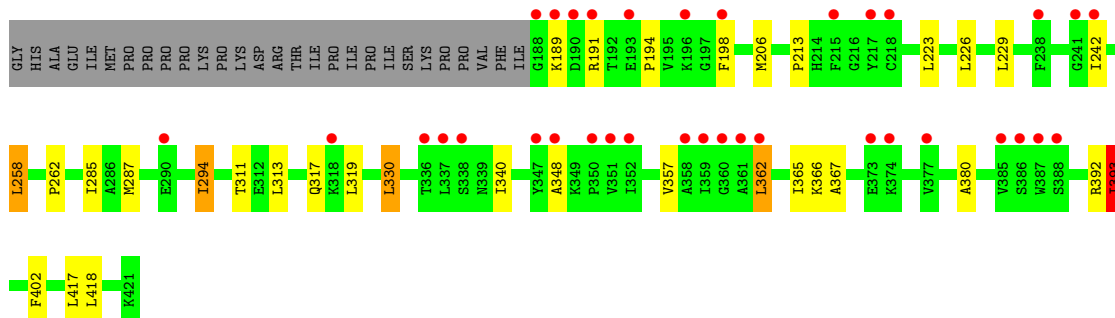

F402  
L417  
L418  
K421

- Molecule 1: Lipoamide acyltransferase component of branched-chain alpha-keto acid dehydrogenase complex

Chain E:

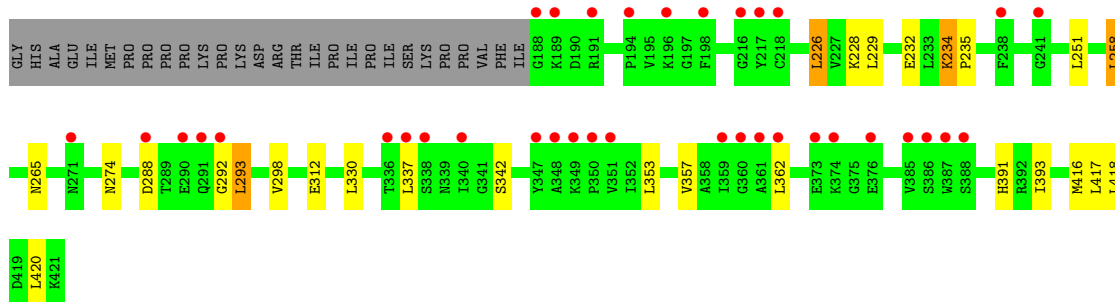

M419  
L420  
K421

- Molecule 1: Lipoamide acyltransferase component of branched-chain alpha-keto acid dehydrogenase complex

Chain F:

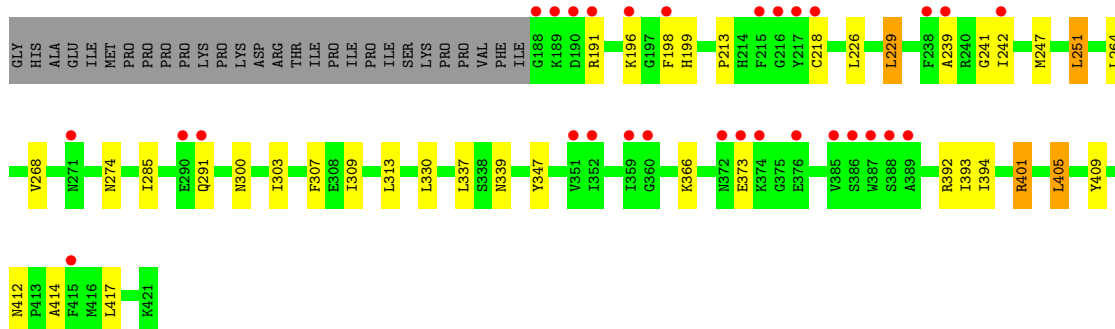

M412  
F413  
A414  
F415  
M416  
L417  
K421

- Molecule 1: Lipoamide acyltransferase component of branched-chain alpha-keto acid dehydrogenase complex

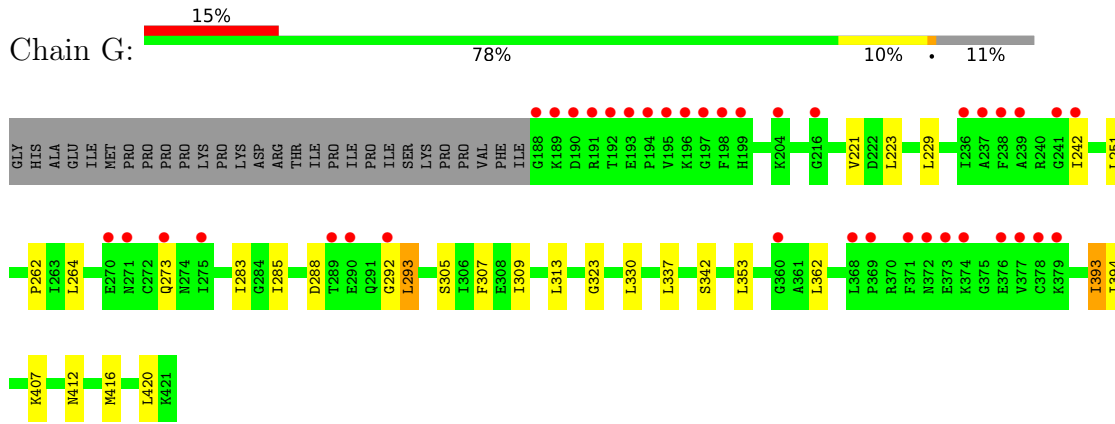

● Molecule 1: Lipoamide acyltransferase component of branched-chain alpha-keto acid dehydrogenase complex

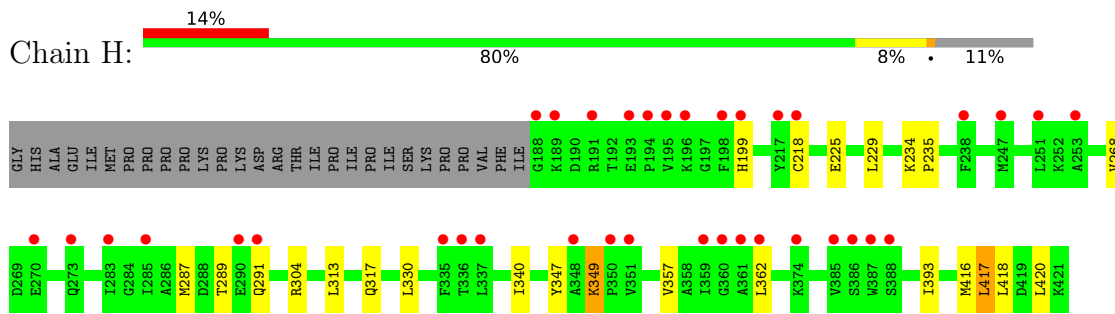

## 4 Data and refinement statistics i

Property	Value	Source
Space group	H 3	Depositor
Cell constants a, b, c, $\alpha$ , $\beta$ , $\gamma$	194.91Å 194.91Å 172.00Å 90.00° 90.00° 120.00°	Depositor
Resolution (Å)	50.00 – 2.17 35.31 – 2.17	Depositor EDS
% Data completeness (in resolution range)	95.7 (50.00-2.17) 95.7 (35.31-2.17)	Depositor EDS
$R_{merge}$	0.05	Depositor
$R_{sym}$	(Not available)	Depositor
$\langle I/\sigma(I) \rangle$ <sup>1</sup>	2.53 (at 2.18Å)	Xtrriage
Refinement program	REFMAC	Depositor
R, $R_{free}$	0.202 , 0.259 0.225 , 0.272	Depositor DCC
$R_{free}$ test set	6243 reflections (5.05%)	wwPDB-VP
Wilson B-factor (Å <sup>2</sup> )	34.9	Xtrriage
Anisotropy	0.275	Xtrriage
Bulk solvent $k_{sol}$ (e/Å <sup>3</sup> ), $B_{sol}$ (Å <sup>2</sup> )	0.36 , 45.3	EDS
L-test for twinning <sup>2</sup>	$\langle  L  \rangle = 0.52$ , $\langle L^2 \rangle = 0.36$	Xtrriage
Estimated twinning fraction	0.003 for h,-h-k,-l	Xtrriage
$F_o, F_c$ correlation	0.95	EDS
Total number of atoms	15647	wwPDB-VP
Average B, all atoms (Å <sup>2</sup> )	39.0	wwPDB-VP

Xtrriage's analysis on translational NCS is as follows: *The largest off-origin peak in the Patterson function is 2.93% of the height of the origin peak. No significant pseudotranslation is detected.*

<sup>1</sup>Intensities estimated from amplitudes.

<sup>2</sup>Theoretical values of  $\langle |L| \rangle$ ,  $\langle L^2 \rangle$  for acentric reflections are 0.5, 0.333 respectively for untwinned datasets, and 0.375, 0.2 for perfectly twinned datasets.

## 5 Model quality

### 5.1 Standard geometry

Bond lengths and bond angles in the following residue types are not validated in this section: CAO, CL, ACT

The Z score for a bond length (or angle) is the number of standard deviations the observed value is removed from the expected value. A bond length (or angle) with  $|Z| > 5$  is considered an outlier worth inspection. RMSZ is the root-mean-square of all Z scores of the bond lengths (or angles).

Mol	Chain	Bond lengths		Bond angles	
		RMSZ	# Z  >5	RMSZ	# Z  >5
1	A	0.91	1/1851 (0.1%)	0.84	1/2500 (0.0%)
1	B	0.92	1/1851 (0.1%)	0.84	2/2500 (0.1%)
1	C	0.88	1/1843 (0.1%)	0.83	2/2489 (0.1%)
1	D	0.89	0/1837	0.85	2/2481 (0.1%)
1	E	0.86	0/1843	0.85	1/2489 (0.0%)
1	F	0.84	0/1843	0.81	1/2489 (0.0%)
1	G	0.80	0/1837	0.79	1/2481 (0.0%)
1	H	0.92	1/1851 (0.1%)	0.83	2/2500 (0.1%)
All	All	0.88	4/14756 (0.0%)	0.83	12/19929 (0.1%)

Chiral center outliers are detected by calculating the chiral volume of a chiral center and verifying if the center is modelled as a planar moiety or with the opposite hand. A planarity outlier is detected by checking planarity of atoms in a peptide group, atoms in a mainchain group or atoms of a sidechain that are expected to be planar.

Mol	Chain	#Chirality outliers	#Planarity outliers
1	C	0	2
1	E	0	1
All	All	0	3

All (4) bond length outliers are listed below:

Mol	Chain	Res	Type	Atoms	Z	Observed(Å)	Ideal(Å)
1	C	292	GLY	N-CA	7.98	1.58	1.46
1	B	217	TYR	CD2-CE2	6.64	1.49	1.39
1	A	189	LYS	CE-NZ	6.60	1.65	1.49
1	H	349	LYS	CE-NZ	5.01	1.61	1.49

The worst 5 of 12 bond angle outliers are listed below:

Mol	Chain	Res	Type	Atoms	Z	Observed(°)	Ideal(°)
1	E	293	LEU	N-CA-C	-6.51	93.42	111.00
1	H	417	LEU	CA-CB-CG	6.10	129.34	115.30
1	B	417	LEU	CA-CB-CG	5.96	129.00	115.30
1	H	362	LEU	CA-CB-CG	-5.58	102.47	115.30
1	D	362	LEU	CA-CB-CG	-5.52	102.59	115.30

There are no chirality outliers.

All (3) planarity outliers are listed below:

Mol	Chain	Res	Type	Group
1	C	291	GLN	Peptide
1	C	292	GLY	Peptide
1	E	292	GLY	Peptide

## 5.2 Too-close contacts [i](#)

In the following table, the Non-H and H(model) columns list the number of non-hydrogen atoms and hydrogen atoms in the chain respectively. The H(added) column lists the number of hydrogen atoms added and optimized by MolProbity. The Clashes column lists the number of clashes within the asymmetric unit, whereas Symm-Clashes lists symmetry-related clashes.

Mol	Chain	Non-H	H(model)	H(added)	Clashes	Symm-Clashes
1	A	1814	0	1869	27	0
1	B	1814	0	1869	28	0
1	C	1806	0	1864	17	0
1	D	1803	0	1859	20	0
1	E	1806	0	1864	15	0
1	F	1806	0	1864	26	0
1	G	1803	0	1859	17	0
1	H	1814	0	1869	10	0
2	A	4	0	3	1	0
2	B	16	0	12	0	0
2	C	12	0	9	0	0
2	D	12	0	9	0	0
2	E	8	0	6	2	0
2	F	12	0	9	0	0
2	G	4	0	3	0	0
2	H	12	0	9	2	0
3	A	1	0	0	1	0
3	B	1	0	0	0	0
3	C	2	0	0	1	0
3	D	1	0	0	0	0

*Continued on next page...*

Continued from previous page...

Mol	Chain	Non-H	H(model)	H(added)	Clashes	Symm-Clashes
3	E	1	0	0	0	0
3	F	2	0	0	0	0
3	G	2	0	0	0	0
3	H	2	0	0	1	0
4	A	49	0	32	3	0
4	B	40	0	21	0	0
4	C	40	0	21	1	0
4	D	40	0	21	6	0
4	E	49	0	32	6	0
4	F	40	0	21	5	0
4	G	49	0	32	3	0
4	H	40	0	21	0	0
5	A	95	0	0	2	0
5	B	102	0	0	2	0
5	C	71	0	0	1	0
5	D	110	0	0	3	0
5	E	93	0	0	2	0
5	F	105	0	0	1	0
5	G	68	0	0	2	0
5	H	98	0	0	2	0
All	All	15647	0	15178	160	0

The all-atom clashscore is defined as the number of clashes found per 1000 atoms (including hydrogen atoms). The all-atom clashscore for this structure is 5.

The worst 5 of 160 close contacts within the same asymmetric unit are listed below, sorted by their clash magnitude.

Atom-1	Atom-2	Interatomic distance (Å)	Clash overlap (Å)
1:E:293:LEU:HD22	4:E:500:CAO:O1P	1.64	0.98
1:E:288:ASP:OD2	1:F:401:ARG:NH2	2.05	0.89
1:A:229:LEU:CD1	1:F:414:ALA:HB1	2.03	0.89
1:A:229:LEU:HD11	1:F:414:ALA:HB1	1.55	0.88
1:F:251:LEU:HD12	1:F:337:LEU:HD12	1.55	0.86

There are no symmetry-related clashes.



## 5.3 Torsion angles [i](#)

### 5.3.1 Protein backbone [i](#)

In the following table, the Percentiles column shows the percent Ramachandran outliers of the chain as a percentile score with respect to all X-ray entries followed by that with respect to entries of similar resolution.

The Analysed column shows the number of residues for which the backbone conformation was analysed, and the total number of residues.

Mol	Chain	Analysed	Favoured	Allowed	Outliers	Percentiles	
1	A	234/262 (89%)	225 (96%)	7 (3%)	2 (1%)	17	15
1	B	234/262 (89%)	229 (98%)	5 (2%)	0	100	100
1	C	233/262 (89%)	224 (96%)	8 (3%)	1 (0%)	34	35
1	D	232/262 (88%)	224 (97%)	8 (3%)	0	100	100
1	E	233/262 (89%)	227 (97%)	6 (3%)	0	100	100
1	F	233/262 (89%)	224 (96%)	8 (3%)	1 (0%)	34	35
1	G	232/262 (88%)	223 (96%)	9 (4%)	0	100	100
1	H	234/262 (89%)	225 (96%)	9 (4%)	0	100	100
All	All	1865/2096 (89%)	1801 (97%)	60 (3%)	4 (0%)	47	52

All (4) Ramachandran outliers are listed below:

Mol	Chain	Res	Type
1	A	290	GLU
1	A	291	GLN
1	F	239	ALA
1	C	292	GLY

### 5.3.2 Protein sidechains [i](#)

In the following table, the Percentiles column shows the percent sidechain outliers of the chain as a percentile score with respect to all X-ray entries followed by that with respect to entries of similar resolution.

The Analysed column shows the number of residues for which the sidechain conformation was analysed, and the total number of residues.

Mol	Chain	Analysed	Rotameric	Outliers	Percentiles	
1	A	198/222 (89%)	182 (92%)	16 (8%)	11	10

*Continued on next page...*

Continued from previous page...

Mol	Chain	Analysed	Rotameric	Outliers	Percentiles	
1	B	198/222 (89%)	186 (94%)	12 (6%)	18	19
1	C	197/222 (89%)	185 (94%)	12 (6%)	18	19
1	D	196/222 (88%)	183 (93%)	13 (7%)	16	16
1	E	197/222 (89%)	189 (96%)	8 (4%)	30	36
1	F	197/222 (89%)	184 (93%)	13 (7%)	16	16
1	G	196/222 (88%)	187 (95%)	9 (5%)	27	31
1	H	198/222 (89%)	190 (96%)	8 (4%)	31	37
All	All	1577/1776 (89%)	1486 (94%)	91 (6%)	20	21

5 of 91 residues with a non-rotameric sidechain are listed below:

Mol	Chain	Res	Type
1	E	353	LEU
1	F	393	ILE
1	E	417	LEU
1	F	251	LEU
1	G	262	PRO

Sometimes sidechains can be flipped to improve hydrogen bonding and reduce clashes. 5 of 19 such sidechains are listed below:

Mol	Chain	Res	Type
1	G	274	ASN
1	H	324	GLN
1	H	381	GLN
1	H	291	GLN
1	D	274	ASN

### 5.3.3 RNA [i](#)

There are no RNA molecules in this entry.

## 5.4 Non-standard residues in protein, DNA, RNA chains [i](#)

There are no non-standard protein/DNA/RNA residues in this entry.

## 5.5 Carbohydrates [i](#)

There are no monosaccharides in this entry.

## 5.6 Ligand geometry [i](#)

Of 40 ligands modelled in this entry, 12 are monoatomic - leaving 28 for Mogul analysis.

In the following table, the Counts columns list the number of bonds (or angles) for which Mogul statistics could be retrieved, the number of bonds (or angles) that are observed in the model and the number of bonds (or angles) that are defined in the Chemical Component Dictionary. The Link column lists molecule types, if any, to which the group is linked. The Z score for a bond length (or angle) is the number of standard deviations the observed value is removed from the expected value. A bond length (or angle) with  $|Z| > 2$  is considered an outlier worth inspection. RMSZ is the root-mean-square of all Z scores of the bond lengths (or angles).

Mol	Type	Chain	Res	Link	Bond lengths			Bond angles		
					Counts	RMSZ	# Z  > 2	Counts	RMSZ	# Z  > 2
4	CAO	F	500	-	35,42,51	0.97	2 (5%)	45,66,76	1.52	5 (11%)
2	ACT	F	600	-	3,3,3	0.82	0	3,3,3	1.48	1 (33%)
2	ACT	F	813	-	3,3,3	0.79	0	3,3,3	1.40	0
2	ACT	D	602	-	3,3,3	0.86	0	3,3,3	1.18	0
2	ACT	A	600	-	3,3,3	0.77	0	3,3,3	1.43	0
2	ACT	D	601	-	3,3,3	0.79	0	3,3,3	1.72	1 (33%)
2	ACT	G	600	-	3,3,3	0.61	0	3,3,3	1.73	1 (33%)
2	ACT	E	815	-	3,3,3	0.69	0	3,3,3	2.16	2 (66%)
4	CAO	A	500	-	41,51,51	1.06	5 (12%)	53,76,76	1.48	9 (16%)
2	ACT	B	601	-	3,3,3	0.65	0	3,3,3	1.01	0
2	ACT	B	602	-	3,3,3	1.02	0	3,3,3	1.38	0
4	CAO	H	500	-	35,42,51	0.94	2 (5%)	45,66,76	1.69	10 (22%)
4	CAO	C	500	-	35,42,51	0.98	3 (8%)	45,66,76	1.34	6 (13%)
2	ACT	H	600	-	3,3,3	1.08	0	3,3,3	1.11	0
2	ACT	C	601	-	3,3,3	0.80	0	3,3,3	0.52	0
2	ACT	F	601	-	3,3,3	0.89	0	3,3,3	1.14	0
4	CAO	D	500	-	35,42,51	0.92	2 (5%)	45,66,76	1.55	7 (15%)
2	ACT	E	600	-	3,3,3	0.46	0	3,3,3	2.10	2 (66%)
2	ACT	B	816	-	3,3,3	0.78	0	3,3,3	1.77	2 (66%)
4	CAO	G	500	-	41,51,51	0.87	1 (2%)	53,76,76	1.52	9 (16%)
2	ACT	C	814	-	3,3,3	0.86	0	3,3,3	1.66	1 (33%)
2	ACT	H	601	-	3,3,3	0.65	0	3,3,3	1.13	0
4	CAO	B	500	-	35,42,51	0.89	2 (5%)	45,66,76	1.46	7 (15%)
2	ACT	D	600	-	3,3,3	0.97	0	3,3,3	1.04	0

Mol	Type	Chain	Res	Link	Bond lengths			Bond angles		
					Counts	RMSZ	# Z  > 2	Counts	RMSZ	# Z  > 2
2	ACT	H	602	-	3,3,3	0.80	0	3,3,3	0.81	0
4	CAO	E	500	-	41,51,51	1.06	5 (12%)	53,76,76	1.37	6 (11%)
2	ACT	C	600	-	3,3,3	0.81	0	3,3,3	1.75	1 (33%)
2	ACT	B	600	-	3,3,3	0.73	0	3,3,3	1.98	1 (33%)

In the following table, the Chirals column lists the number of chiral outliers, the number of chiral centers analysed, the number of these observed in the model and the number defined in the Chemical Component Dictionary. Similar counts are reported in the Torsion and Rings columns. '-' means no outliers of that kind were identified.

Mol	Type	Chain	Res	Link	Chirals	Torsions	Rings
4	CAO	F	500	-	1/1/10/13	12/33/54/65	0/3/3/3
4	CAO	B	500	-	1/1/10/13	7/33/54/65	0/3/3/3
4	CAO	A	500	-	-	3/44/65/65	0/3/3/3
4	CAO	D	500	-	-	11/33/54/65	0/3/3/3
4	CAO	G	500	-	-	6/44/65/65	0/3/3/3
4	CAO	E	500	-	-	8/44/65/65	0/3/3/3
4	CAO	H	500	-	1/1/10/13	9/33/54/65	0/3/3/3
4	CAO	C	500	-	-	8/33/54/65	0/3/3/3

The worst 5 of 22 bond length outliers are listed below:

Mol	Chain	Res	Type	Atoms	Z	Observed(Å)	Ideal(Å)
4	A	500	CAO	O4B-C1B	2.77	1.44	1.41
4	A	500	CAO	C5A-C4A	2.74	1.48	1.40
4	E	500	CAO	OAP-CAP	2.69	1.47	1.42
4	B	500	CAO	C5A-C4A	2.50	1.47	1.40
4	F	500	CAO	P3B-O3B	2.44	1.63	1.59

The worst 5 of 71 bond angle outliers are listed below:

Mol	Chain	Res	Type	Atoms	Z	Observed(°)	Ideal(°)
4	G	500	CAO	N3A-C2A-N1A	-4.48	121.67	128.68
4	D	500	CAO	CDP-CBP-CCP	-4.33	101.16	108.23
4	F	500	CAO	O9P-C9P-CAP	4.26	123.14	119.04
4	B	500	CAO	N3A-C2A-N1A	-4.24	122.05	128.68
4	H	500	CAO	OAP-CAP-C9P	-4.22	103.19	110.93

All (3) chirality outliers are listed below:

Mol	Chain	Res	Type	Atom
4	B	500	CAO	C2B
4	F	500	CAO	CAP
4	H	500	CAO	CAP

5 of 64 torsion outliers are listed below:

Mol	Chain	Res	Type	Atoms
4	A	500	CAO	C5B-O5B-P1A-O2A
4	A	500	CAO	C5B-O5B-P1A-O3A
4	A	500	CAO	S1P-C2P-C3P-N4P
4	B	500	CAO	P1A-O3A-P2A-O6A
4	B	500	CAO	O9P-C9P-CAP-OAP

There are no ring outliers.

9 monomers are involved in 24 short contacts:

Mol	Chain	Res	Type	Clashes	Symm-Clashes
4	F	500	CAO	5	0
2	A	600	ACT	1	0
4	A	500	CAO	3	0
4	C	500	CAO	1	0
4	D	500	CAO	6	0
2	E	600	ACT	2	0
4	G	500	CAO	3	0
2	H	602	ACT	2	0
4	E	500	CAO	6	0

The following is a two-dimensional graphical depiction of Mogul quality analysis of bond lengths, bond angles, torsion angles, and ring geometry for all instances of the Ligand of Interest. In addition, ligands with molecular weight > 250 and outliers as shown on the validation Tables will also be included. For torsion angles, if less than 5% of the Mogul distribution of torsion angles is within 10 degrees of the torsion angle in question, then that torsion angle is considered an outlier. Any bond that is central to one or more torsion angles identified as an outlier by Mogul will be highlighted in the graph. For rings, the root-mean-square deviation (RMSD) between the ring in question and similar rings identified by Mogul is calculated over all ring torsion angles. If the average RMSD is greater than 60 degrees and the minimal RMSD between the ring in question and any Mogul-identified rings is also greater than 60 degrees, then that ring is considered an outlier. The outliers are highlighted in purple. The color gray indicates Mogul did not find sufficient equivalents in the CSD to analyse the geometry.

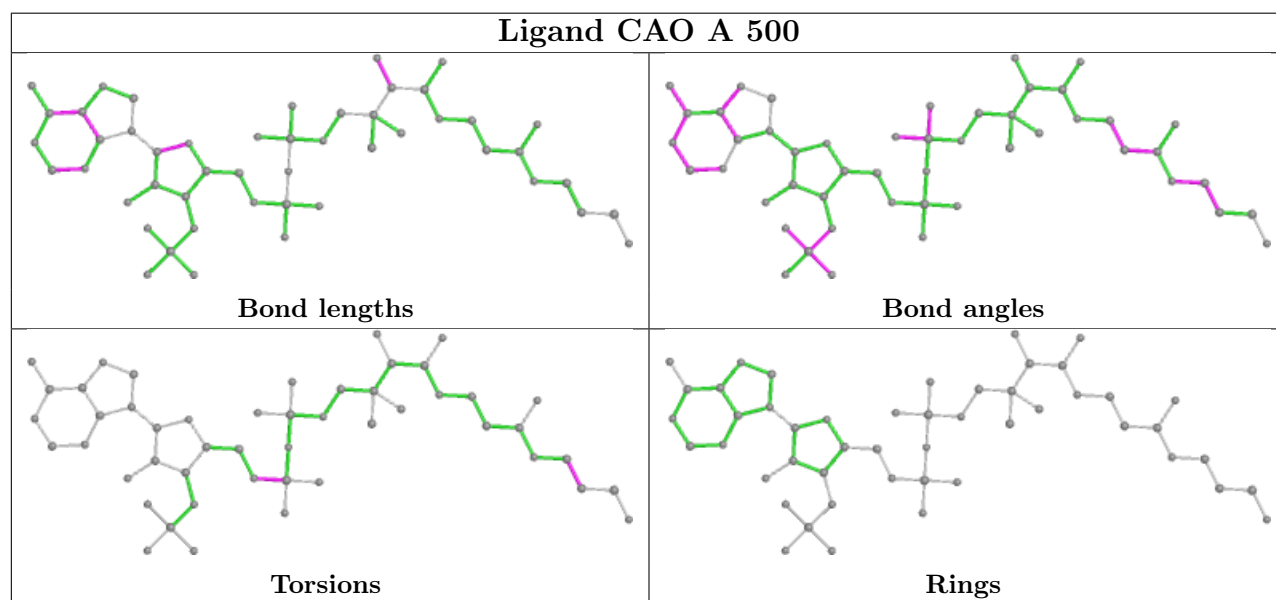
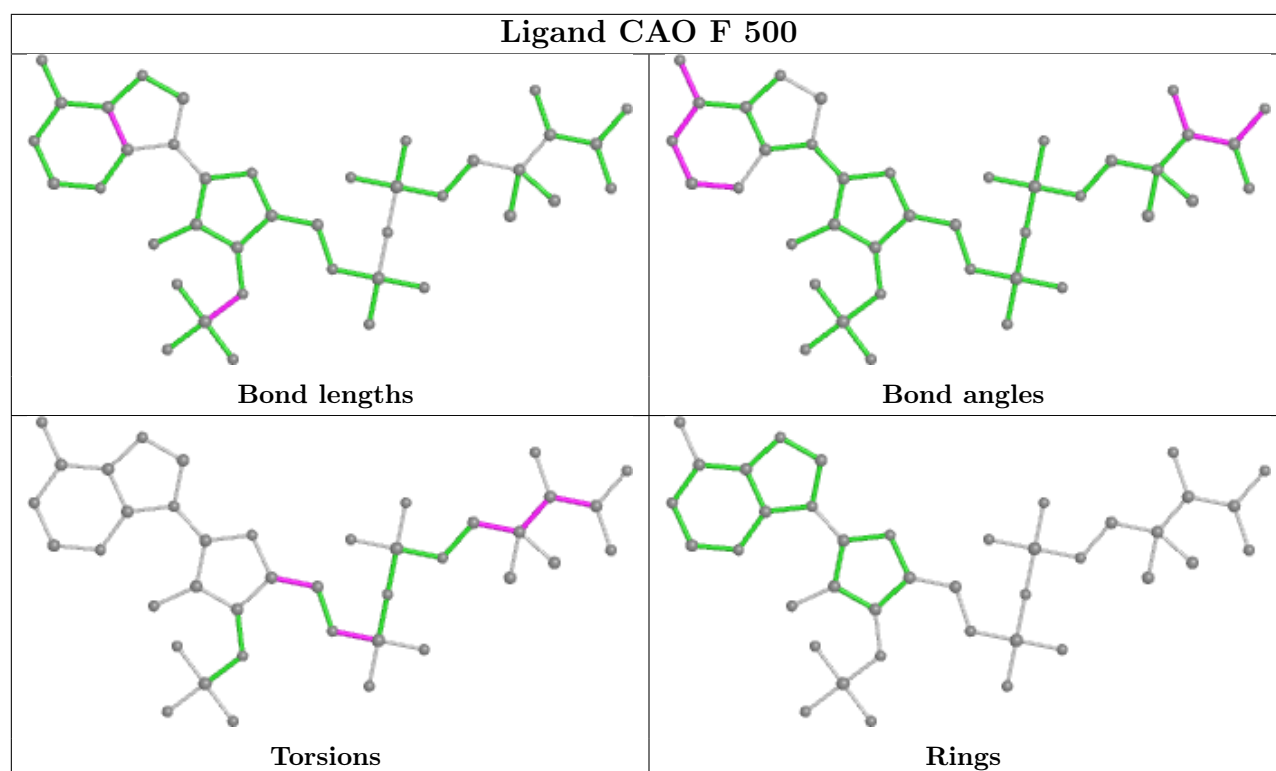

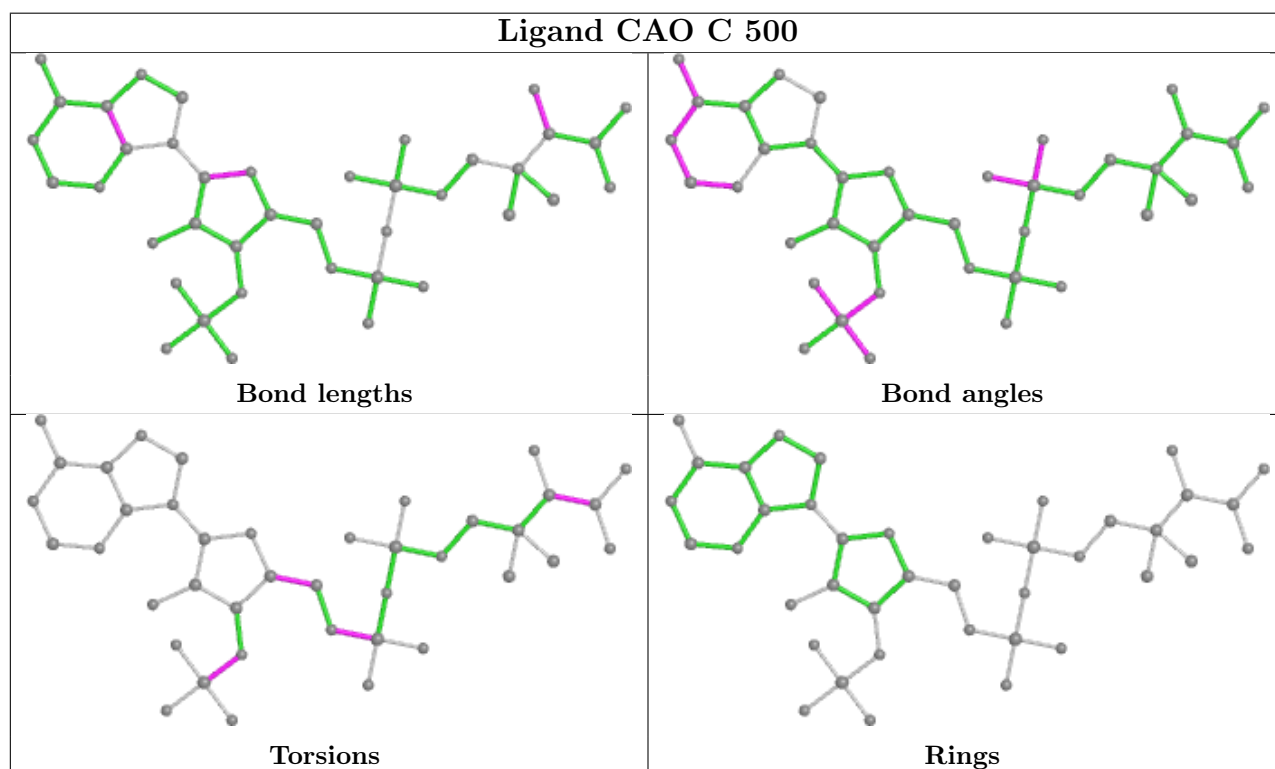
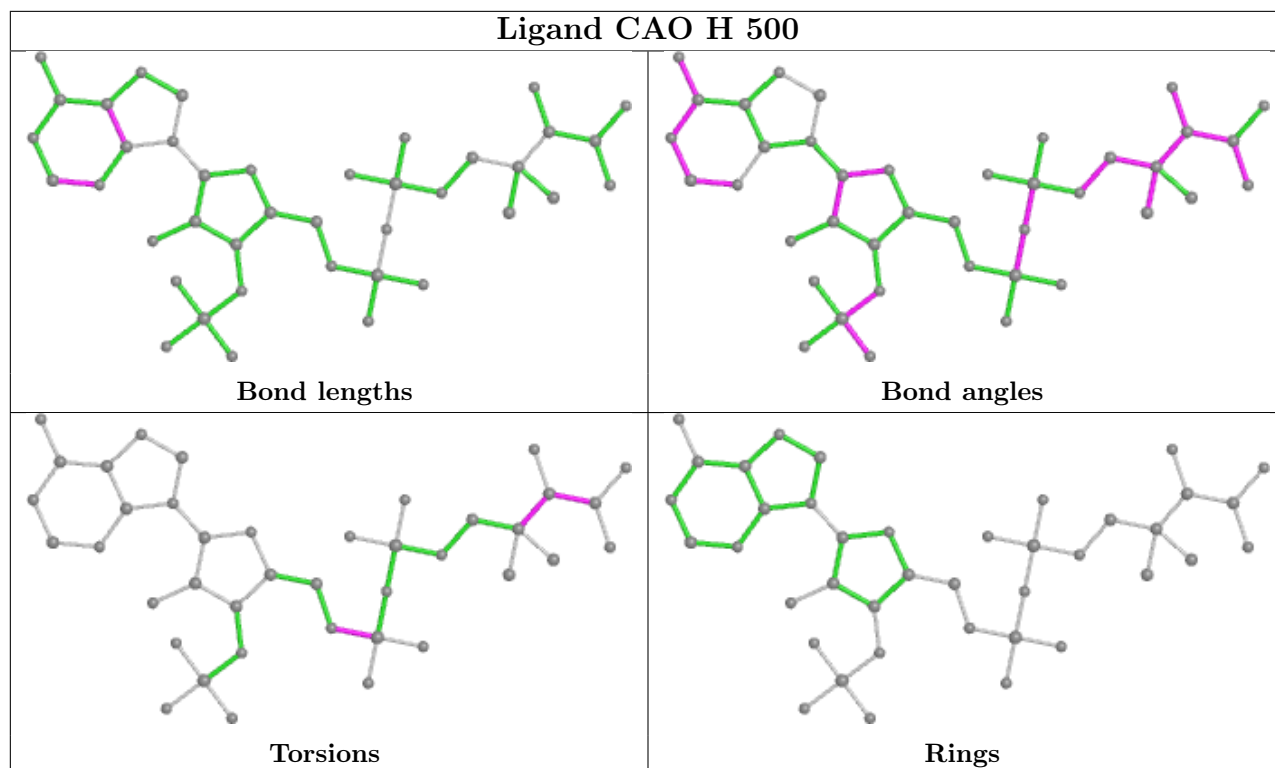

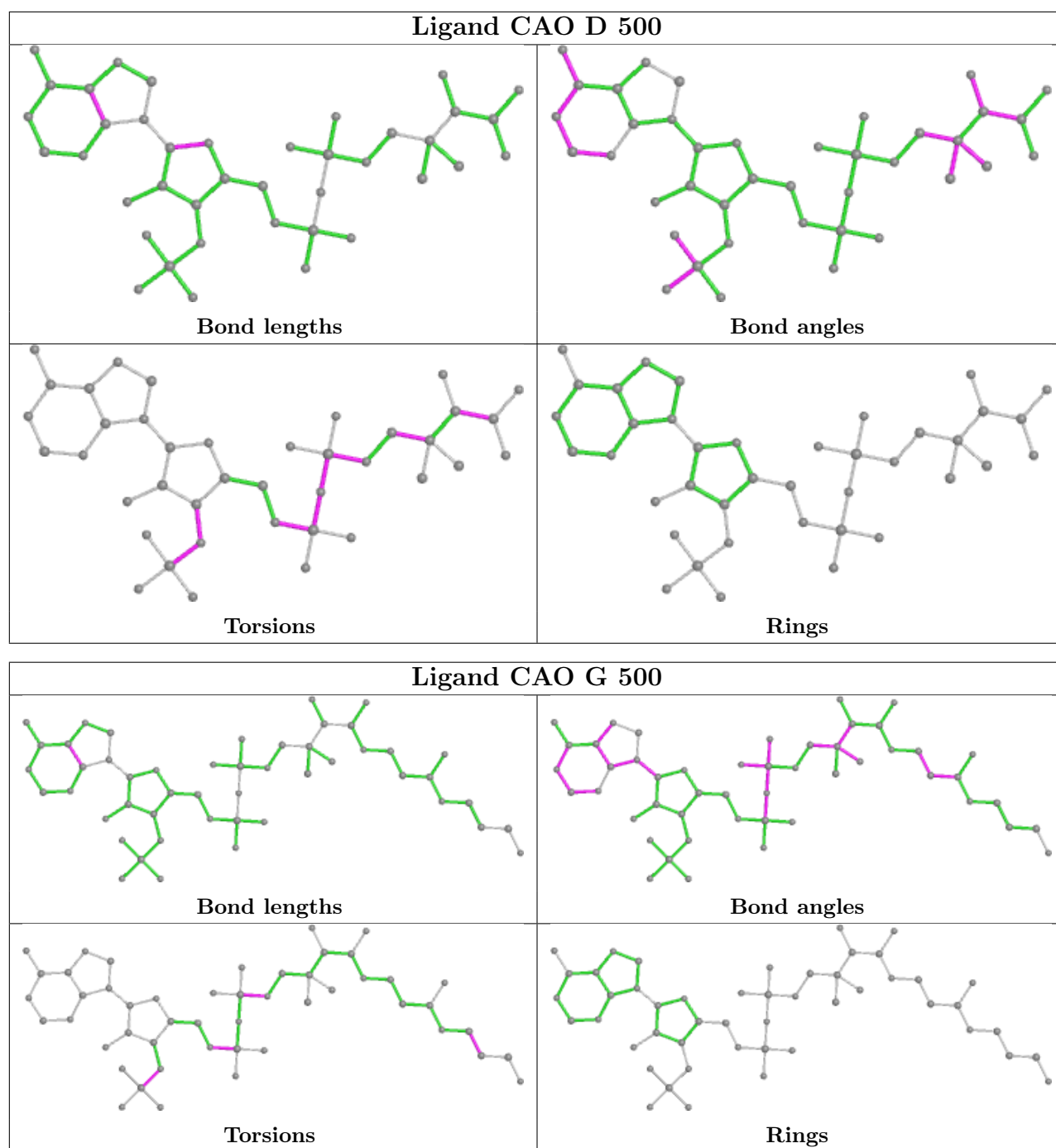



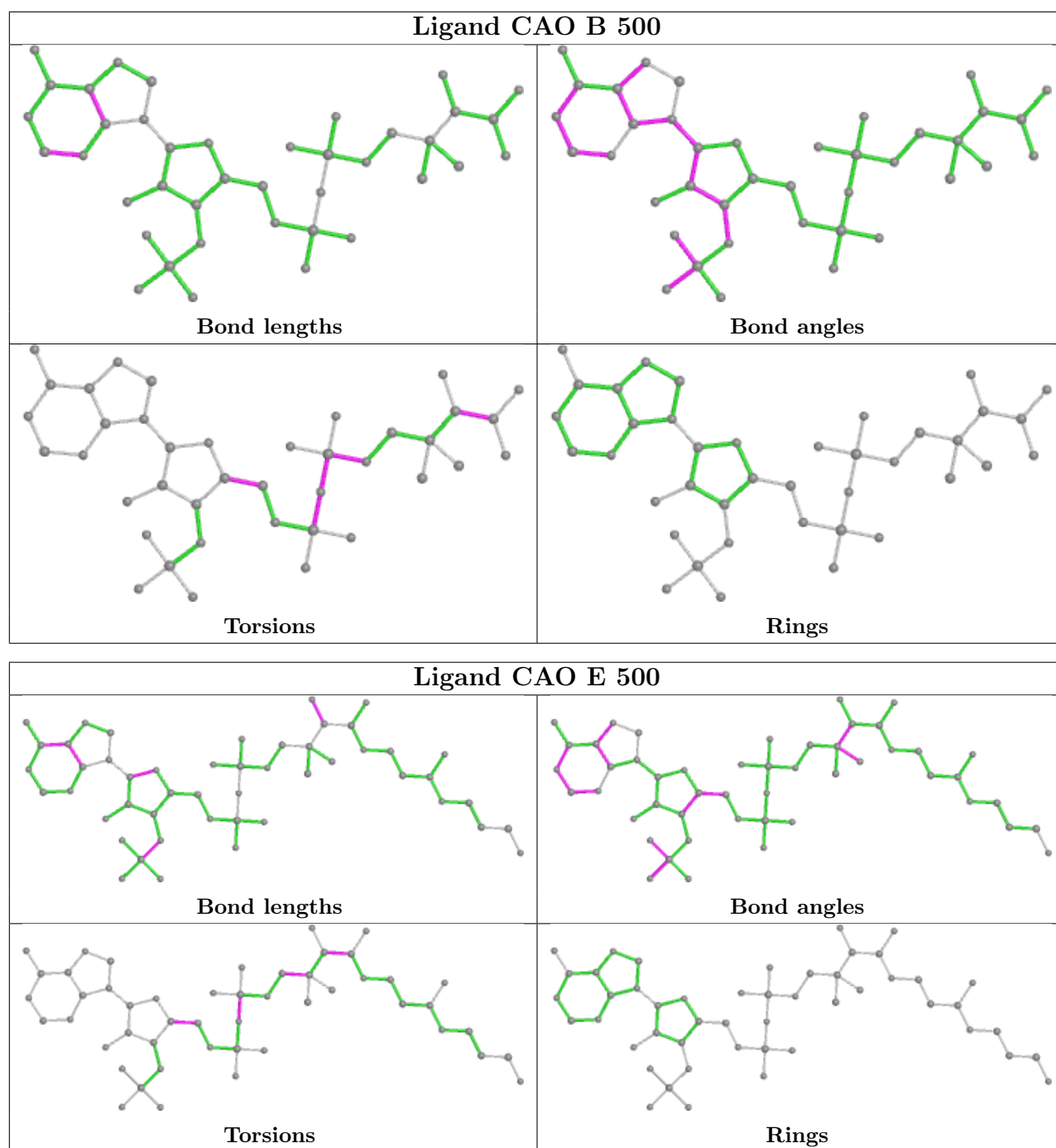

## 5.7 Other polymers [\(i\)](#)

There are no such residues in this entry.

## 5.8 Polymer linkage issues [\(i\)](#)

There are no chain breaks in this entry.

## 6 Fit of model and data [i](#)

### 6.1 Protein, DNA and RNA chains [i](#)

In the following table, the column labelled ‘#RSRZ > 2’ contains the number (and percentage) of RSRZ outliers, followed by percent RSRZ outliers for the chain as percentile scores relative to all X-ray entries and entries of similar resolution. The OWAB column contains the minimum, median, 95<sup>th</sup> percentile and maximum values of the occupancy-weighted average B-factor per residue. The column labelled ‘Q < 0.9’ lists the number of (and percentage) of residues with an average occupancy less than 0.9.

Mol	Chain	Analysed	<RSRZ>	#RSRZ>2	OWAB(Å <sup>2</sup> )	Q<0.9
1	A	234/262 (89%)	0.64	27 (11%) 4 5	31, 37, 50, 64	0
1	B	234/262 (89%)	0.56	31 (13%) 3 3	30, 36, 49, 63	0
1	C	234/262 (89%)	0.53	28 (11%) 4 4	30, 37, 49, 68	0
1	D	234/262 (89%)	0.52	35 (14%) 2 2	31, 37, 47, 60	0
1	E	234/262 (89%)	0.62	36 (15%) 2 2	31, 37, 51, 62	0
1	F	234/262 (89%)	0.55	30 (12%) 3 3	31, 37, 48, 61	0
1	G	234/262 (89%)	0.72	38 (16%) 1 1	29, 37, 50, 59	0
1	H	234/262 (89%)	0.65	36 (15%) 2 2	31, 36, 50, 61	0
All	All	1872/2096 (89%)	0.60	261 (13%) 2 2	29, 37, 49, 68	0

The worst 5 of 261 RSRZ outliers are listed below:

Mol	Chain	Res	Type	RSRZ
1	G	198	PHE	8.9
1	A	198	PHE	8.1
1	G	238	PHE	7.1
1	E	198	PHE	7.0
1	F	188	GLY	6.9

### 6.2 Non-standard residues in protein, DNA, RNA chains [i](#)

There are no non-standard protein/DNA/RNA residues in this entry.

### 6.3 Carbohydrates [i](#)

There are no monosaccharides in this entry.

## 6.4 Ligands

In the following table, the Atoms column lists the number of modelled atoms in the group and the number defined in the chemical component dictionary. The B-factors column lists the minimum, median, 95<sup>th</sup> percentile and maximum values of B factors of atoms in the group. The column labelled 'Q< 0.9' lists the number of atoms with occupancy less than 0.9.

Mol	Type	Chain	Res	Atoms	RSCC	RSR	B-factors(Å <sup>2</sup> )	Q<0.9
2	ACT	E	815	4/4	0.46	0.29	49,52,52,54	0
2	ACT	C	814	4/4	0.67	0.30	58,59,59,60	0
2	ACT	B	602	4/4	0.74	0.21	40,41,43,43	0
2	ACT	B	816	4/4	0.74	0.22	60,61,61,62	0
3	CL	G	810	1/1	0.80	0.09	66,66,66,66	1
3	CL	A	802	1/1	0.86	0.25	67,67,67,67	0
3	CL	F	804	1/1	0.89	0.19	63,63,63,63	0
3	CL	E	806	1/1	0.90	0.14	68,68,68,68	0
4	CAO	D	500	40/49	0.90	0.13	51,62,68,71	0
3	CL	D	805	1/1	0.91	0.13	59,59,59,59	0
2	ACT	A	600	4/4	0.91	0.14	42,43,43,44	0
2	ACT	F	813	4/4	0.91	0.23	60,61,61,61	0
2	ACT	D	602	4/4	0.91	0.17	65,65,65,65	0
3	CL	C	803	1/1	0.91	0.27	62,62,62,62	0
3	CL	H	809	1/1	0.92	0.17	58,58,58,58	0
4	CAO	H	500	40/49	0.92	0.14	35,54,62,64	0
4	CAO	B	500	40/49	0.93	0.12	44,55,63,64	0
4	CAO	C	500	40/49	0.93	0.13	41,54,61,61	0
2	ACT	E	600	4/4	0.93	0.18	39,40,40,41	0
4	CAO	F	500	40/49	0.93	0.13	47,64,81,82	0
4	CAO	G	500	49/49	0.93	0.11	45,54,64,66	0
4	CAO	A	500	49/49	0.93	0.11	37,48,56,56	0
2	ACT	H	602	4/4	0.94	0.28	74,75,75,75	0
2	ACT	D	600	4/4	0.94	0.17	38,38,39,40	0
2	ACT	H	601	4/4	0.94	0.12	33,35,36,37	0
2	ACT	B	600	4/4	0.95	0.17	34,34,35,35	0
3	CL	B	801	1/1	0.95	0.22	63,63,63,63	0
2	ACT	F	600	4/4	0.95	0.12	33,33,34,35	0
2	ACT	B	601	4/4	0.95	0.09	34,36,36,37	0
2	ACT	G	600	4/4	0.95	0.13	42,42,42,43	0
4	CAO	E	500	49/49	0.95	0.10	32,43,50,52	0
2	ACT	C	600	4/4	0.95	0.10	39,40,40,40	0
2	ACT	C	601	4/4	0.95	0.13	37,39,39,40	0
3	CL	G	811	1/1	0.95	0.28	69,69,69,69	0
3	CL	F	808	1/1	0.96	0.12	66,66,66,66	0
2	ACT	F	601	4/4	0.96	0.09	30,32,32,33	0
2	ACT	H	600	4/4	0.96	0.13	34,34,35,35	0

*Continued on next page...*

Continued from previous page...

Mol	Type	Chain	Res	Atoms	RSCC	RSR	B-factors(Å <sup>2</sup> )	Q<0.9
3	CL	C	807	1/1	0.97	0.14	62,62,62,62	0
2	ACT	D	601	4/4	0.97	0.07	29,30,31,32	0
3	CL	H	812	1/1	0.99	0.17	52,52,52,52	1

The following is a graphical depiction of the model fit to experimental electron density of all instances of the Ligand of Interest. In addition, ligands with molecular weight > 250 and outliers as shown on the geometry validation Tables will also be included. Each fit is shown from different orientation to approximate a three-dimensional view.

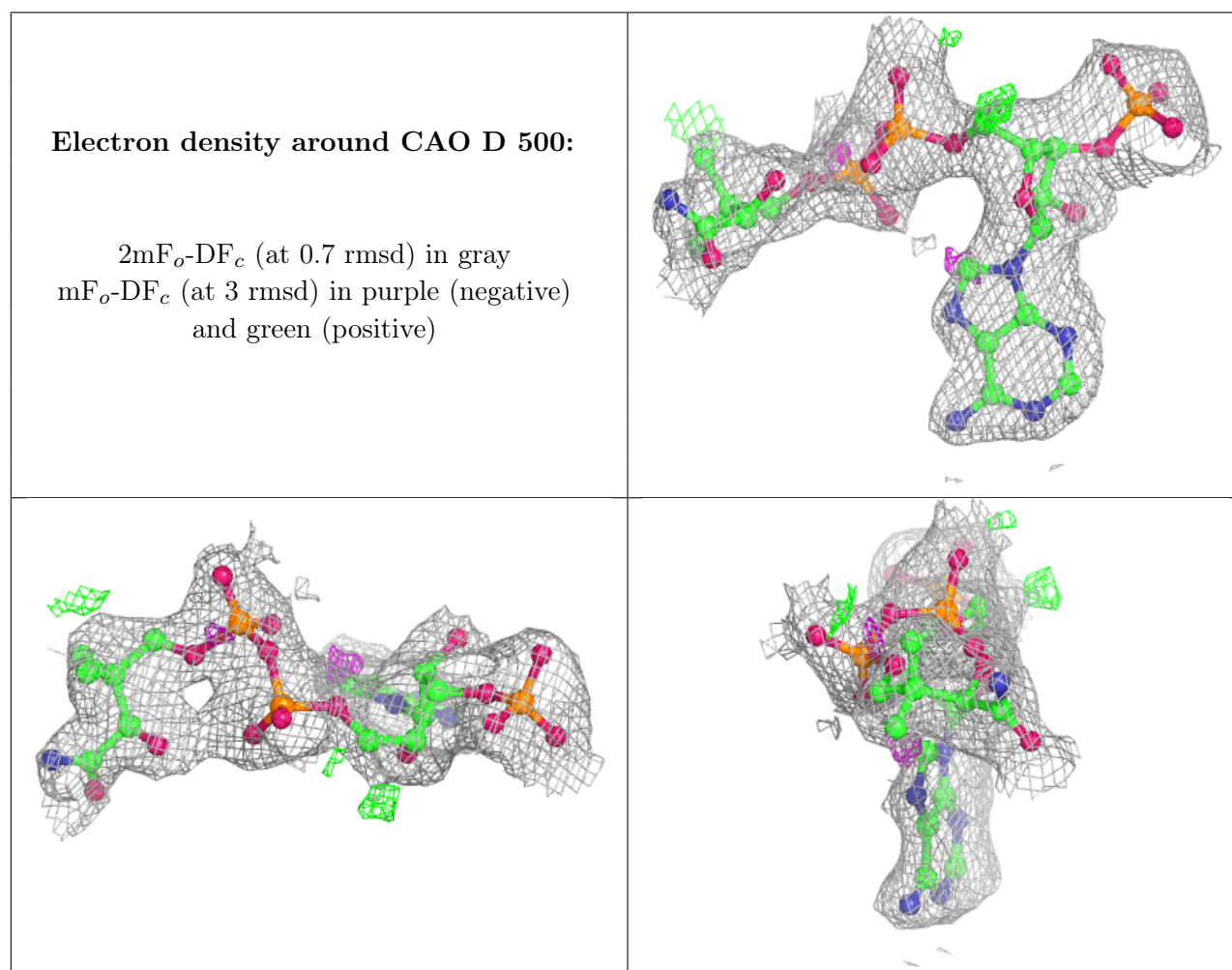

**Electron density around CAO H 500:**

$2mF_o-DF_c$  (at 0.7 rmsd) in gray  
 $mF_o-DF_c$  (at 3 rmsd) in purple (negative)  
and green (positive)

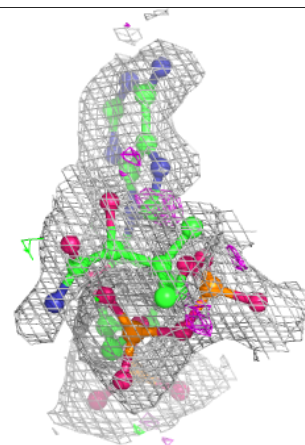
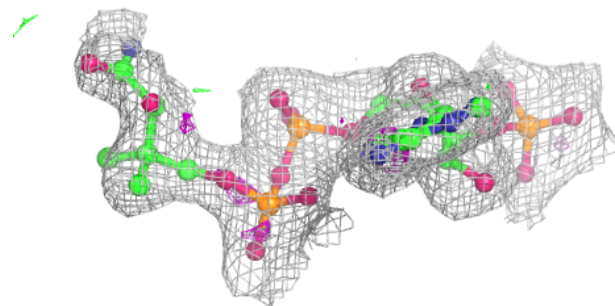
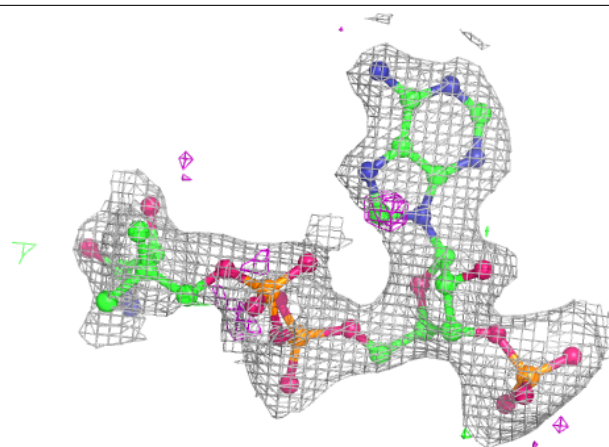

**Electron density around CAO B 500:**

$2mF_o-DF_c$  (at 0.7 rmsd) in gray  
 $mF_o-DF_c$  (at 3 rmsd) in purple (negative)  
and green (positive)

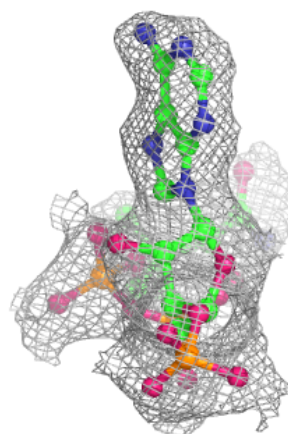
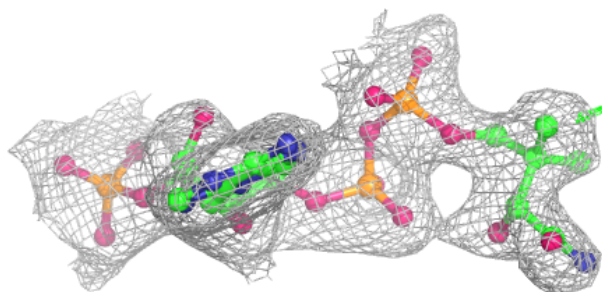
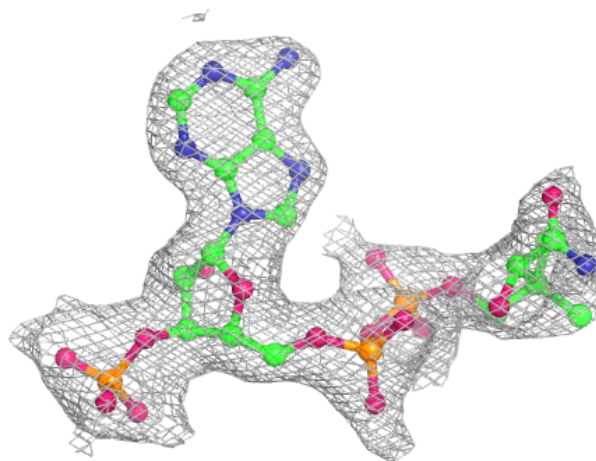

**Electron density around CAO C 500:**

$2mF_o-DF_c$  (at 0.7 rmsd) in gray  
 $mF_o-DF_c$  (at 3 rmsd) in purple (negative)  
and green (positive)

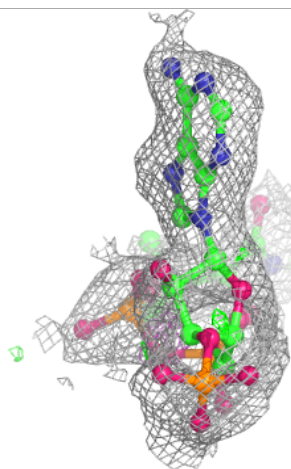
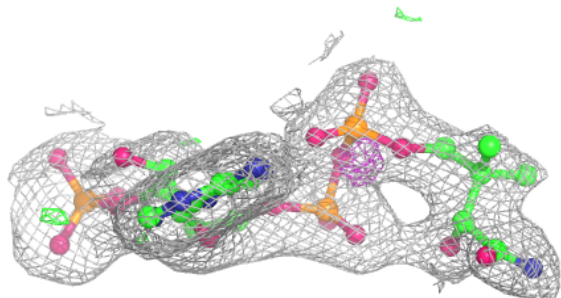
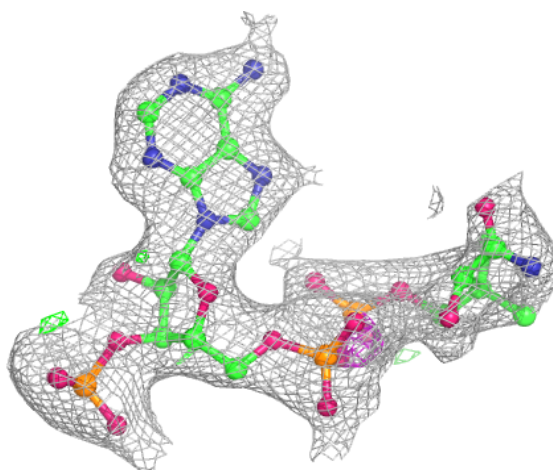

**Electron density around CAO F 500:**

$2mF_o-DF_c$  (at 0.7 rmsd) in gray  
 $mF_o-DF_c$  (at 3 rmsd) in purple (negative)  
and green (positive)

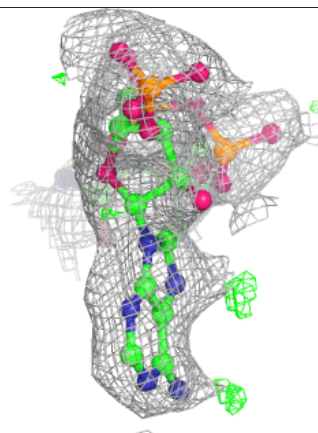
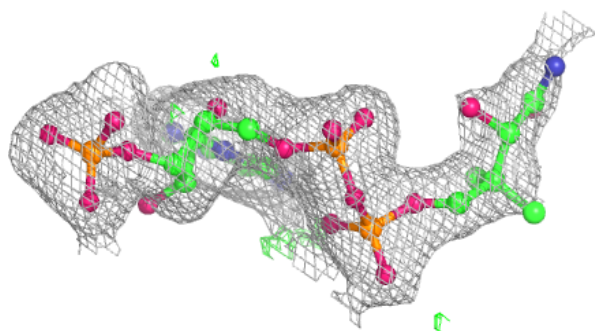
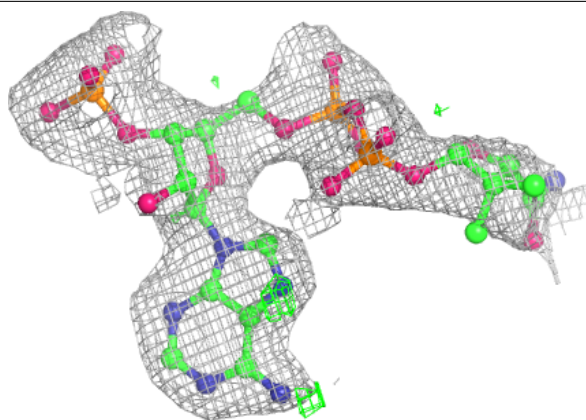
**Electron density around CAO G 500:**

$2mF_o-DF_c$  (at 0.7 rmsd) in gray  
 $mF_o-DF_c$  (at 3 rmsd) in purple (negative)  
and green (positive)

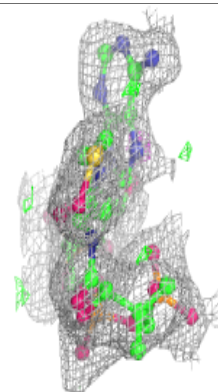
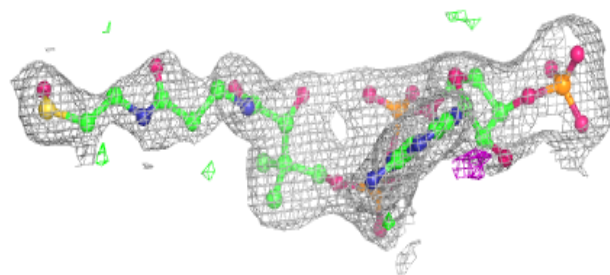
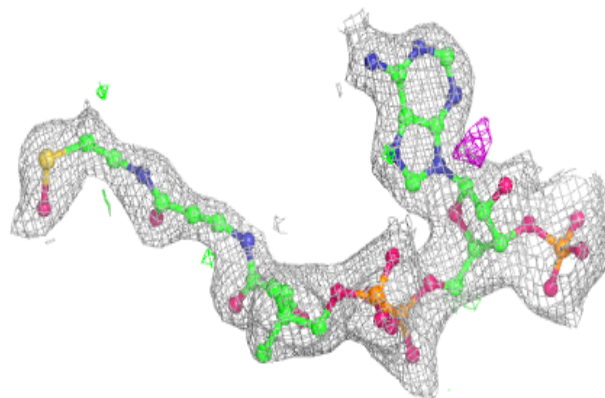



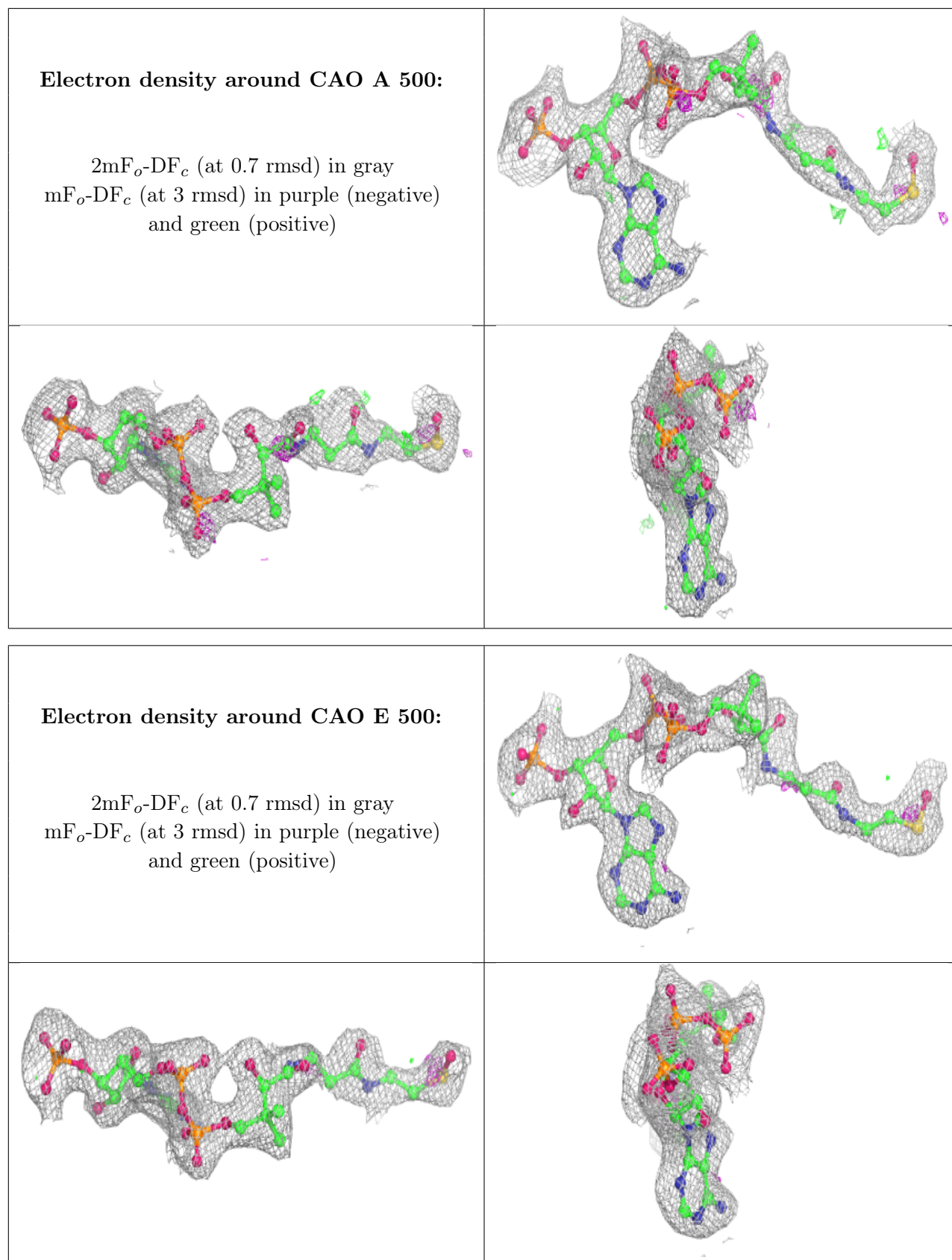

## 6.5 Other polymers [i](#)

There are no such residues in this entry.