



Full wwPDB X-ray Structure Validation Report ⓘ

Dec 10, 2023 – 01:06 am GMT

PDB ID : 1UMP
Title : GEOMETRY OF TRITERPENE CONVERSION TO PENTACARBOCYCLIC HOPENE
Authors : Reinert, D.J.; Balliano, G.; Schulz, G.E.
Deposited on : 2003-08-27
Resolution : 2.13 Å(reported)

This is a Full wwPDB X-ray Structure Validation Report for a publicly released PDB entry.

We welcome your comments at validation@mail.wwpdb.org

A user guide is available at

<https://www.wwpdb.org/validation/2017/XrayValidationReportHelp>

with specific help available everywhere you see the ⓘ symbol.

The types of validation reports are described at

<http://www.wwpdb.org/validation/2017/FAQs#types>.

The following versions of software and data (see [references ⓘ](#)) were used in the production of this report:

MolProbity : 4.02b-467
Mogul : 1.8.4, CSD as541be (2020)
Xtriage (Phenix) : 1.13
EDS : 2.36
buster-report : 1.1.7 (2018)
Percentile statistics : 20191225.v01 (using entries in the PDB archive December 25th 2019)
Refmac : 5.8.0158
CCP4 : 7.0.044 (Gargrove)
Ideal geometry (proteins) : Engh & Huber (2001)
Ideal geometry (DNA, RNA) : Parkinson et al. (1996)
Validation Pipeline (wwPDB-VP) : 2.36

1 Overall quality at a glance

The following experimental techniques were used to determine the structure:

X-RAY DIFFRACTION

The reported resolution of this entry is 2.13 Å.

Percentile scores (ranging between 0-100) for global validation metrics of the entry are shown in the following graphic. The table shows the number of entries on which the scores are based.

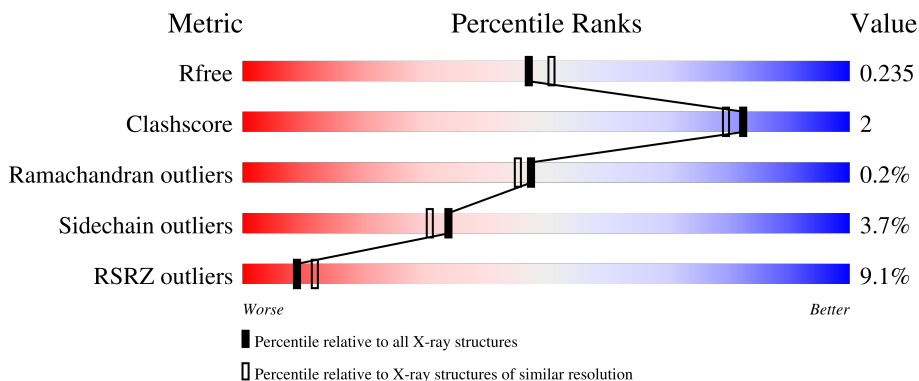

Metric	Whole archive (#Entries)	Similar resolution (#Entries, resolution range(Å))
R_{free}	130704	2523 (2.16-2.12)
Clashscore	141614	2653 (2.16-2.12)
Ramachandran outliers	138981	2618 (2.16-2.12)
Sidechain outliers	138945	2617 (2.16-2.12)
RSRZ outliers	127900	2485 (2.16-2.12)

The table below summarises the geometric issues observed across the polymeric chains and their fit to the electron density. The red, orange, yellow and green segments of the lower bar indicate the fraction of residues that contain outliers for ≥ 3 , 2, 1 and 0 types of geometric quality criteria respectively. A grey segment represents the fraction of residues that are not modelled. The numeric value for each fraction is indicated below the corresponding segment, with a dot representing fractions $\leq 5\%$. The upper red bar (where present) indicates the fraction of residues that have poor fit to the electron density. The numeric value is given above the bar.

Mol	Chain	Length	Quality of chain
1	A	631	 11% 88% 10% .
1	B	631	 4% 89% 9% .
1	C	631	 12% 87% 10% ..

2 Entry composition [i](#)

There are 4 unique types of molecules in this entry. The entry contains 16339 atoms, of which 0 are hydrogens and 0 are deuteriums.

In the tables below, the ZeroOcc column contains the number of atoms modelled with zero occupancy, the AltConf column contains the number of residues with at least one atom in alternate conformation and the Trace column contains the number of residues modelled with at most 2 atoms.

- Molecule 1 is a protein called SQUALENE–HOPENE CYCLASE.

Mol	Chain	Residues	Atoms					ZeroOcc	AltConf	Trace
			Total	C	N	O	S			
1	A	620	Total 4964	C 3188	N 859	O 897	S 20	0	0	1
1	B	620	Total 4964	C 3188	N 859	O 897	S 20	0	0	1
1	C	620	Total 4964	C 3188	N 859	O 897	S 20	0	0	1

- Molecule 2 is (HYDROXYETHYLOXY)TRI(ETHYLOXY)OCTANE (three-letter code: C8E) (formula: C₁₆H₃₄O₅).

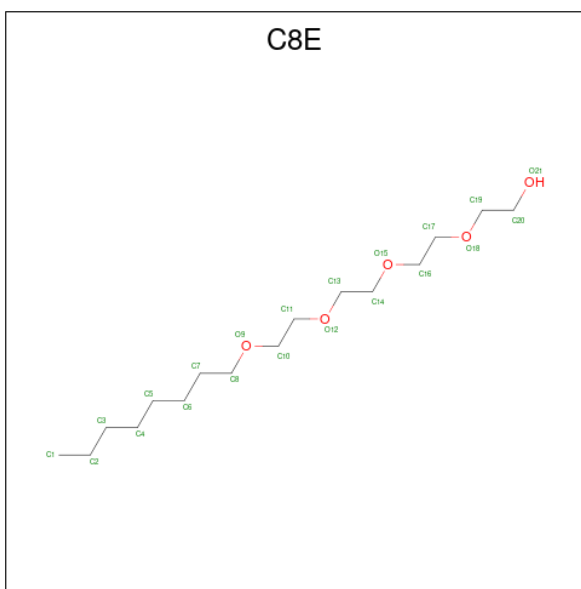

Mol	Chain	Residues	Atoms			ZeroOcc	AltConf
2	A	1	Total 21	C 16	O 5	0	0
2	B	1	Total 21	C 16	O 5	0	0
2	B	1	Total 42	C 32	O 10	0	1

Continued on next page...

Continued from previous page...

Mol	Chain	Residues	Atoms			ZeroOcc	AltConf
2	C	1	Total	C	O	0	0
			21	16	5		
2	C	1	Total	C	O	0	1
			42	32	10		

- Molecule 3 is 2-AZASQUALENE (three-letter code: SQA) (formula: C₂₉H₅₁N).

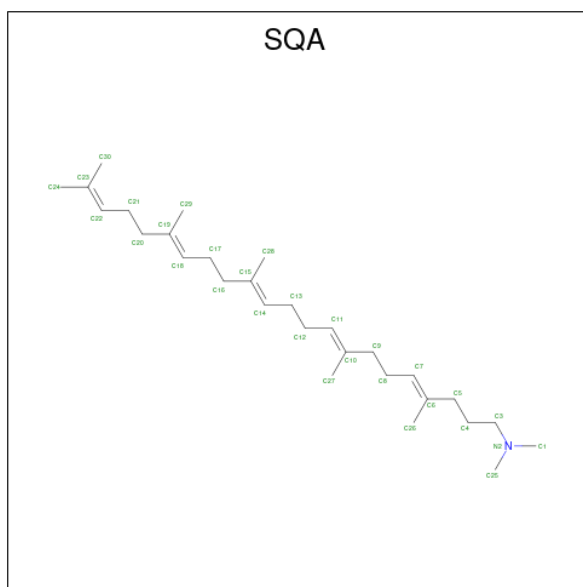

Mol	Chain	Residues	Atoms			ZeroOcc	AltConf
3	A	1	Total	C	N	0	0
			30	29	1		
3	B	1	Total	C	N	0	0
			30	29	1		
3	C	1	Total	C	N	0	0
			30	29	1		

- Molecule 4 is water.

Mol	Chain	Residues	Atoms		ZeroOcc	AltConf
4	A	318	Total	O	0	0
			318	318		
4	B	526	Total	O	0	0
			526	526		
4	C	366	Total	O	0	0
			366	366		

3 Residue-property plots [i](#)

These plots are drawn for all protein, RNA, DNA and oligosaccharide chains in the entry. The first graphic for a chain summarises the proportions of the various outlier classes displayed in the second graphic. The second graphic shows the sequence view annotated by issues in geometry and electron density. Residues are color-coded according to the number of geometric quality criteria for which they contain at least one outlier: green = 0, yellow = 1, orange = 2 and red = 3 or more. A red dot above a residue indicates a poor fit to the electron density ($RSRZ > 2$). Stretches of 2 or more consecutive residues without any outlier are shown as a green connector. Residues present in the sample, but not in the model, are shown in grey.

- Molecule 1: SQUALENE-HOPENE CYCLASE

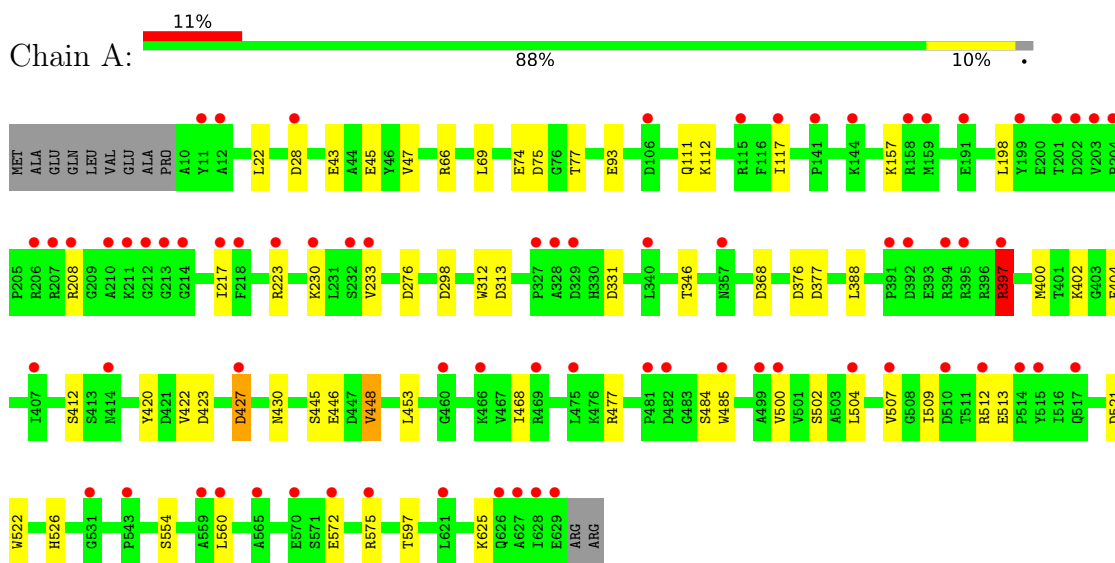

- Molecule 1: SQUALENE-HOPENE CYCLASE

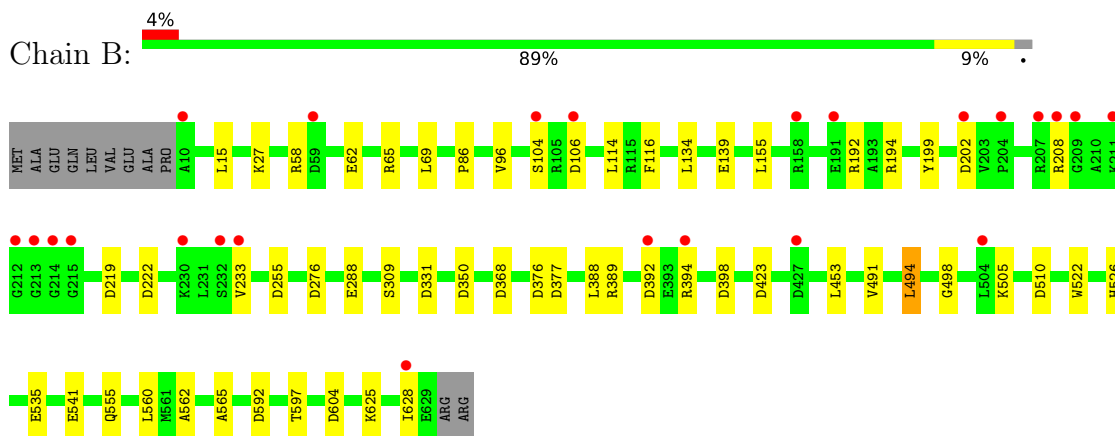

- Molecule 1: SQUALENE-HOPENE CYCLASE

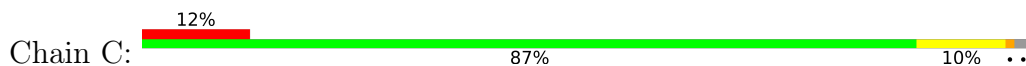

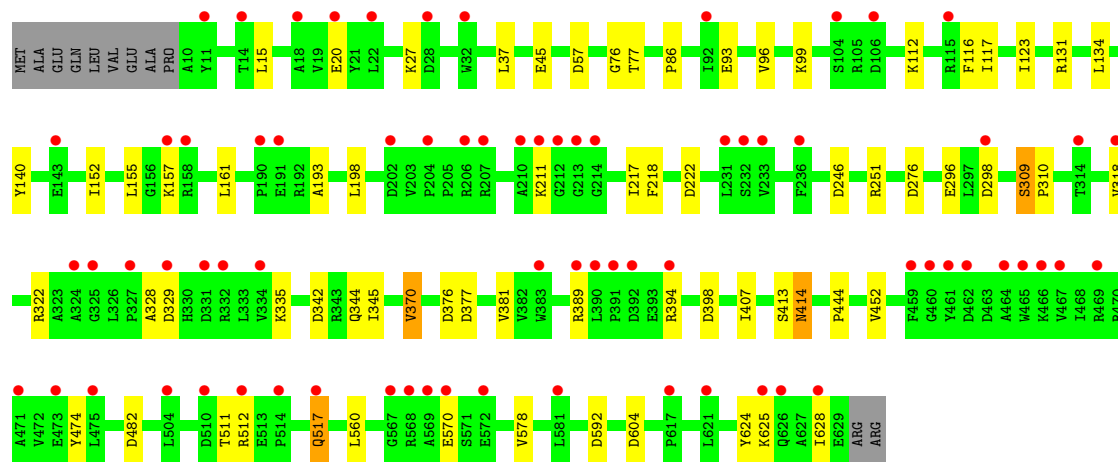

4 Data and refinement statistics

Property	Value	Source
Space group	P 32 2 1	Depositor
Cell constants a, b, c, α , β , γ	139.14Å 139.14Å 240.70Å 90.00° 90.00° 120.00°	Depositor
Resolution (Å)	19.73 – 2.13 19.55 – 2.13	Depositor EDS
% Data completeness (in resolution range)	100.0 (19.73-2.13) 99.6 (19.55-2.13)	Depositor EDS
R_{merge}	0.05	Depositor
R_{sym}	(Not available)	Depositor
$\langle I/\sigma(I) \rangle$ ¹	3.85 (at 2.13Å)	Xtrriage
Refinement program	REFMAC 5.1.24	Depositor
R, R_{free}	0.186 , 0.228 0.196 , 0.235	Depositor DCC
R_{free} test set	3691 reflections (2.46%)	wwPDB-VP
Wilson B-factor (Å ²)	37.5	Xtrriage
Anisotropy	0.075	Xtrriage
Bulk solvent k_{sol} (e/Å ³), B_{sol} (Å ²)	0.38 , 53.1	EDS
L-test for twinning ²	$\langle L \rangle = 0.47$, $\langle L^2 \rangle = 0.30$	Xtrriage
Estimated twinning fraction	0.014 for -h,-k,l	Xtrriage
F_o, F_c correlation	0.95	EDS
Total number of atoms	16339	wwPDB-VP
Average B, all atoms (Å ²)	26.0	wwPDB-VP

Xtrriage's analysis on translational NCS is as follows: *The analyses of the Patterson function reveals a significant off-origin peak that is 20.84 % of the origin peak, indicating pseudo-translational symmetry. The chance of finding a peak of this or larger height randomly in a structure without pseudo-translational symmetry is equal to 7.9592e-03. The detected translational NCS is most likely also responsible for the elevated intensity ratio.*

¹Intensities estimated from amplitudes.

²Theoretical values of $\langle |L| \rangle$, $\langle L^2 \rangle$ for acentric reflections are 0.5, 0.333 respectively for untwinned datasets, and 0.375, 0.2 for perfectly twinned datasets.

5 Model quality i

5.1 Standard geometry i

Bond lengths and bond angles in the following residue types are not validated in this section: C8E, SQA

The Z score for a bond length (or angle) is the number of standard deviations the observed value is removed from the expected value. A bond length (or angle) with $|Z| > 5$ is considered an outlier worth inspection. RMSZ is the root-mean-square of all Z scores of the bond lengths (or angles).

Mol	Chain	Bond lengths		Bond angles	
		RMSZ	# $ Z > 5$	RMSZ	# $ Z > 5$
1	A	0.60	1/5117 (0.0%)	0.78	10/6967 (0.1%)
1	B	0.64	0/5117	0.81	16/6967 (0.2%)
1	C	0.59	0/5117	0.79	10/6967 (0.1%)
All	All	0.61	1/15351 (0.0%)	0.79	36/20901 (0.2%)

All (1) bond length outliers are listed below:

Mol	Chain	Res	Type	Atoms	Z	Observed(Å)	Ideal(Å)
1	A	484	SER	CB-OG	10.74	1.56	1.42

All (36) bond angle outliers are listed below:

Mol	Chain	Res	Type	Atoms	Z	Observed(°)	Ideal(°)
1	B	255	ASP	CB-CG-OD2	7.62	125.16	118.30
1	C	57	ASP	CB-CG-OD2	7.37	124.93	118.30
1	C	398	ASP	CB-CG-OD2	7.17	124.76	118.30
1	B	628	ILE	O-C-N	-6.88	111.68	122.70
1	A	276	ASP	CB-CG-OD2	6.80	124.42	118.30
1	C	298	ASP	CB-CG-OD2	6.59	124.24	118.30
1	A	331	ASP	CB-CG-OD2	6.42	124.08	118.30
1	B	222	ASP	CB-CG-OD2	6.40	124.06	118.30
1	A	368	ASP	CB-CG-OD2	6.25	123.93	118.30
1	A	427	ASP	CB-CG-OD2	6.22	123.90	118.30
1	B	368	ASP	CB-CG-OD2	6.04	123.74	118.30
1	B	377	ASP	CB-CG-OD2	6.03	123.73	118.30
1	B	106	ASP	CB-CG-OD2	5.96	123.66	118.30
1	A	423	ASP	CB-CG-OD2	5.88	123.59	118.30
1	A	521	ASP	CB-CG-OD2	5.86	123.57	118.30
1	B	604	ASP	CB-CG-OD2	5.78	123.50	118.30
1	C	222	ASP	CB-CG-OD2	5.78	123.50	118.30

Continued on next page...

Continued from previous page...

Mol	Chain	Res	Type	Atoms	Z	Observed(°)	Ideal(°)
1	B	392	ASP	CB-CG-OD2	5.71	123.44	118.30
1	B	331	ASP	CB-CG-OD2	5.65	123.39	118.30
1	A	377	ASP	CB-CG-OD2	5.63	123.36	118.30
1	A	397	ARG	NE-CZ-NH1	5.60	123.10	120.30
1	B	510	ASP	CB-CG-OD2	5.59	123.33	118.30
1	C	628	ILE	O-C-N	-5.54	113.83	122.70
1	C	246	ASP	CB-CG-OD2	5.49	123.24	118.30
1	B	423	ASP	CB-CG-OD2	5.42	123.18	118.30
1	B	350	ASP	CB-CG-OD2	5.27	123.04	118.30
1	A	298	ASP	CB-CG-OD1	5.26	123.03	118.30
1	C	329	ASP	CB-CG-OD2	5.25	123.02	118.30
1	A	313	ASP	CB-CG-OD2	5.24	123.02	118.30
1	C	342	ASP	CB-CG-OD2	5.23	123.01	118.30
1	C	592	ASP	CB-CG-OD2	5.19	122.97	118.30
1	B	219	ASP	CB-CG-OD2	5.18	122.96	118.30
1	B	202	ASP	CB-CG-OD2	5.15	122.93	118.30
1	B	592	ASP	CB-CG-OD2	5.13	122.92	118.30
1	B	276	ASP	CB-CG-OD2	5.07	122.86	118.30
1	C	482	ASP	CB-CG-OD2	5.03	122.83	118.30

There are no chirality outliers.

There are no planarity outliers.

5.2 Too-close contacts [i](#)

In the following table, the Non-H and H(model) columns list the number of non-hydrogen atoms and hydrogen atoms in the chain respectively. The H(added) column lists the number of hydrogen atoms added and optimized by MolProbity. The Clashes column lists the number of clashes within the asymmetric unit, whereas Symm-Clashes lists symmetry-related clashes.

Mol	Chain	Non-H	H(model)	H(added)	Clashes	Symm-Clashes
1	A	4964	0	4787	23	0
1	B	4964	0	4787	17	0
1	C	4964	0	4787	29	0
2	A	21	0	34	2	0
2	B	63	0	102	1	0
2	C	63	0	102	4	0
3	A	30	0	51	4	0
3	B	30	0	51	0	0
3	C	30	0	51	1	0
4	A	318	0	0	8	1

Continued on next page...

Continued from previous page...

Mol	Chain	Non-H	H(model)	H(added)	Clashes	Symm-Clashes
4	B	526	0	0	3	1
4	C	366	0	0	3	1
All	All	16339	0	14752	74	2

The all-atom clashscore is defined as the number of clashes found per 1000 atoms (including hydrogen atoms). The all-atom clashscore for this structure is 2.

All (74) close contacts within the same asymmetric unit are listed below, sorted by their clash magnitude.

Atom-1	Atom-2	Interatomic distance (Å)	Clash overlap (Å)
1:C:276:ASP:OD2	4:C:2169:HOH:O	2.05	0.74
1:C:512:ARG:HA	1:C:517:GLN:NE2	2.08	0.69
1:A:75:ASP:HB3	1:A:77:THR:HG23	1.76	0.67
1:A:420:TYR:HB2	4:A:2219:HOH:O	1.96	0.65
1:A:446:GLU:HB2	4:A:2248:HOH:O	2.01	0.60
1:C:155:LEU:HD11	2:C:1630[B]:C8E:C17	2.33	0.58
1:A:522:TRP:HA	4:A:2259:HOH:O	2.05	0.57
1:C:296:GLU:O	4:C:2192:HOH:O	2.17	0.57
1:C:345:ILE:HG23	1:C:370:VAL:HG22	1.86	0.57
1:C:414:ASN:ND2	1:C:474:TYR:CE1	2.73	0.56
1:A:397:ARG:HG3	1:A:397:ARG:HH11	1.70	0.56
1:C:161:LEU:HD11	1:C:218:PHE:CE1	2.41	0.56
1:C:511:THR:O	1:C:517:GLN:NE2	2.39	0.56
1:B:491:VAL:HG13	1:B:597:THR:C	2.28	0.54
1:A:402:LYS:NZ	4:A:2211:HOH:O	2.41	0.53
1:B:491:VAL:HG22	1:B:555:GLN:NE2	2.24	0.53
1:A:485:TRP:CE2	1:A:500:VAL:HG11	2.45	0.51
1:A:157:LYS:NZ	2:A:1629:C8E:H13	2.26	0.51
1:C:344:GLN:OE1	4:C:2209:HOH:O	2.19	0.51
1:C:155:LEU:HD11	2:C:1630[B]:C8E:H171	1.93	0.51
1:B:139:GLU:O	1:B:199:TYR:OH	2.26	0.51
1:C:414:ASN:ND2	1:C:444:PRO:HB2	2.26	0.51
1:A:117:ILE:HG21	1:A:198:LEU:HD22	1.93	0.50
3:A:1630:SQA:H3C2	3:A:1630:SQA:C7	2.40	0.50
1:A:485:TRP:CD2	1:A:500:VAL:HG11	2.46	0.50
1:C:309:SER:N	1:C:310:PRO:CD	2.74	0.49
1:C:76:GLY:HA3	1:C:112:LYS:HB3	1.94	0.49
1:B:388:LEU:C	1:B:389:ARG:HH11	2.15	0.49
1:B:155:LEU:HD21	2:B:1630[B]:C8E:H142	1.95	0.49
1:B:494:LEU:HD22	1:B:535:GLU:HB2	1.97	0.47
1:B:62:GLU:OE1	1:B:65:ARG:NH1	2.48	0.47

Continued on next page...

Continued from previous page...

Atom-1	Atom-2	Interatomic distance (Å)	Clash overlap (Å)
1:A:445:SER:OG	1:A:448:VAL:HG13	2.14	0.47
1:A:445:SER:HG	1:A:448:VAL:HG13	1.78	0.47
1:C:251:ARG:HH22	2:C:1629:C8E:H52	1.80	0.46
1:B:388:LEU:O	1:B:389:ARG:NH1	2.48	0.46
1:A:526:HIS:NE2	4:A:2260:HOH:O	2.30	0.46
1:A:45:GLU:OE2	1:A:93:GLU:OE1	2.34	0.46
1:C:86:PRO:HB2	1:C:116:PHE:CZ	2.52	0.45
1:A:453:LEU:HD22	1:A:468:ILE:HG23	1.99	0.45
1:B:288:GLU:CD	4:B:2246:HOH:O	2.55	0.44
1:A:312:TRP:CZ2	3:A:1630:SQA:H1C1	2.52	0.44
1:C:96:VAL:HG21	1:C:134:LEU:HD21	1.99	0.44
1:B:522:TRP:NE1	1:B:526:HIS:HE1	2.16	0.43
1:C:377:ASP:O	1:C:381:VAL:HG23	2.18	0.43
1:B:86:PRO:HB2	1:B:116:PHE:CZ	2.53	0.43
3:A:1630:SQA:H283	3:A:1630:SQA:H11	2.01	0.43
1:C:152:ILE:HD12	2:C:1630[B]:C8E:H192	2.00	0.43
1:C:211:LYS:NZ	1:C:604:ASP:OD2	2.40	0.43
1:C:328:ALA:HB1	1:C:389:ARG:H	1.83	0.43
1:A:66:ARG:NH1	4:A:2048:HOH:O	2.51	0.43
1:C:77:THR:HG21	1:C:86:PRO:HB3	2.00	0.42
1:A:412:SER:HB3	4:A:2223:HOH:O	2.19	0.42
1:C:131:ARG:HD2	1:C:140:TYR:CZ	2.55	0.42
2:A:1629:C8E:H31	4:A:2135:HOH:O	2.19	0.42
3:C:1631:SQA:H8C2	3:C:1631:SQA:H261	1.80	0.42
1:B:96:VAL:HG21	1:B:134:LEU:HD21	2.01	0.41
1:A:507:VAL:HG23	1:A:509:ILE:HG12	2.01	0.41
1:C:578:VAL:HG21	1:C:624:TYR:CE2	2.55	0.41
1:A:554:SER:OG	1:A:597:THR:HG21	2.20	0.41
3:A:1630:SQA:H271	3:A:1630:SQA:H121	1.82	0.41
1:C:123:ILE:HD11	1:C:198:LEU:HB2	2.01	0.41
1:C:318:VAL:O	1:C:322:ARG:HB2	2.20	0.41
1:C:407:ILE:HG21	1:C:452:VAL:HG13	2.02	0.41
1:A:74:GLU:O	1:A:112:LYS:NZ	2.33	0.41
1:B:498:GLY:HA2	1:B:562:ALA:HB2	2.03	0.41
1:B:505:LYS:HD3	1:B:565:ALA:O	2.20	0.41
1:C:117:ILE:HG21	1:C:198:LEU:HD22	2.03	0.41
1:B:192:ARG:NH2	4:B:2175:HOH:O	2.48	0.41
1:C:99:LYS:HG2	1:C:193:ALA:HA	2.03	0.41
1:A:400:MET:O	1:A:404:PHE:HB2	2.20	0.40
1:C:45:GLU:OE2	1:C:93:GLU:OE1	2.40	0.40
1:A:43:GLU:O	1:A:47:VAL:HG23	2.22	0.40

Continued on next page...

Continued from previous page...

Atom-1	Atom-2	Interatomic distance (Å)	Clash overlap (Å)
1:B:58:ARG:O	1:B:62:GLU:HG2	2.22	0.40
1:B:625:LYS:NZ	4:B:2524:HOH:O	2.55	0.40

All (2) symmetry-related close contacts are listed below. The label for Atom-2 includes the symmetry operator and encoded unit-cell translations to be applied.

Atom-1	Atom-2	Interatomic distance (Å)	Clash overlap (Å)
4:A:2212:HOH:O	4:C:2274:HOH:O[5_565]	2.10	0.10
4:B:2130:HOH:O	4:B:2272:HOH:O[5_555]	2.17	0.03

5.3 Torsion angles [i](#)

5.3.1 Protein backbone [i](#)

In the following table, the Percentiles column shows the percent Ramachandran outliers of the chain as a percentile score with respect to all X-ray entries followed by that with respect to entries of similar resolution.

The Analysed column shows the number of residues for which the backbone conformation was analysed, and the total number of residues.

Mol	Chain	Analysed	Favoured	Allowed	Outliers	Percentiles	
1	A	618/631 (98%)	600 (97%)	18 (3%)	0	100	100
1	B	618/631 (98%)	603 (98%)	14 (2%)	1 (0%)	47	45
1	C	618/631 (98%)	597 (97%)	19 (3%)	2 (0%)	41	36
All	All	1854/1893 (98%)	1800 (97%)	51 (3%)	3 (0%)	47	45

All (3) Ramachandran outliers are listed below:

Mol	Chain	Res	Type
1	C	414	ASN
1	C	309	SER
1	B	309	SER

5.3.2 Protein sidechains [i](#)

In the following table, the Percentiles column shows the percent sidechain outliers of the chain as a percentile score with respect to all X-ray entries followed by that with respect to entries of similar

resolution.

The Analysed column shows the number of residues for which the sidechain conformation was analysed, and the total number of residues.

Mol	Chain	Analysed	Rotameric	Outliers	Percentiles	
1	A	503/513 (98%)	477 (95%)	26 (5%)	23	18
1	B	503/513 (98%)	488 (97%)	15 (3%)	41	39
1	C	503/513 (98%)	488 (97%)	15 (3%)	41	39
All	All	1509/1539 (98%)	1453 (96%)	56 (4%)	34	31

All (56) residues with a non-rotameric sidechain are listed below:

Mol	Chain	Res	Type
1	A	22	LEU
1	A	28	ASP
1	A	69	LEU
1	A	111	GLN
1	A	208	ARG
1	A	217	ILE
1	A	223	ARG
1	A	230	LYS
1	A	233	VAL
1	A	346	THR
1	A	376	ASP
1	A	388	LEU
1	A	397	ARG
1	A	422	VAL
1	A	427	ASP
1	A	430	ASN
1	A	448	VAL
1	A	477	ARG
1	A	502	SER
1	A	504	LEU
1	A	512	ARG
1	A	513	GLU
1	A	560	LEU
1	A	572	GLU
1	A	575	ARG
1	A	625	LYS
1	B	15	LEU
1	B	27	LYS
1	B	69	LEU
1	B	104	SER

Continued on next page...

Continued from previous page...

Mol	Chain	Res	Type
1	B	114	LEU
1	B	194	ARG
1	B	208	ARG
1	B	233	VAL
1	B	376	ASP
1	B	394	ARG
1	B	398	ASP
1	B	453	LEU
1	B	494	LEU
1	B	541	GLU
1	B	560	LEU
1	C	15	LEU
1	C	20	GLU
1	C	27	LYS
1	C	37	LEU
1	C	157	LYS
1	C	217	ILE
1	C	335	LYS
1	C	370	VAL
1	C	376	ASP
1	C	394	ARG
1	C	413	SER
1	C	517	GLN
1	C	560	LEU
1	C	570	GLU
1	C	625	LYS

Sometimes sidechains can be flipped to improve hydrogen bonding and reduce clashes. All (7) such sidechains are listed below:

Mol	Chain	Res	Type
1	A	184	GLN
1	A	614	HIS
1	B	431	HIS
1	B	526	HIS
1	C	414	ASN
1	C	517	GLN
1	C	626	GLN

5.3.3 RNA

There are no RNA molecules in this entry.

5.4 Non-standard residues in protein, DNA, RNA chains [i](#)

There are no non-standard protein/DNA/RNA residues in this entry.

5.5 Carbohydrates [i](#)

There are no monosaccharides in this entry.

5.6 Ligand geometry [i](#)

10 ligands are modelled in this entry.

In the following table, the Counts columns list the number of bonds (or angles) for which Mogul statistics could be retrieved, the number of bonds (or angles) that are observed in the model and the number of bonds (or angles) that are defined in the Chemical Component Dictionary. The Link column lists molecule types, if any, to which the group is linked. The Z score for a bond length (or angle) is the number of standard deviations the observed value is removed from the expected value. A bond length (or angle) with $|Z| > 2$ is considered an outlier worth inspection. RMSZ is the root-mean-square of all Z scores of the bond lengths (or angles).

Mol	Type	Chain	Res	Link	Bond lengths			Bond angles		
					Counts	RMSZ	# Z > 2	Counts	RMSZ	# Z > 2
2	C8E	A	1629	-	20,20,20	0.42	0	19,19,19	0.57	0
3	SQA	B	1631	-	29,29,29	0.70	0	34,34,34	0.83	1 (2%)
2	C8E	C	1629	-	20,20,20	0.38	0	19,19,19	0.75	0
2	C8E	B	1629	-	20,20,20	0.46	0	19,19,19	0.68	0
2	C8E	B	1630[A]	-	20,20,20	0.54	0	19,19,19	0.42	0
2	C8E	C	1630[A]	-	20,20,20	0.52	0	19,19,19	0.48	0
2	C8E	B	1630[B]	-	20,20,20	0.44	0	19,19,19	0.37	0
3	SQA	A	1630	-	29,29,29	0.60	0	34,34,34	1.30	3 (8%)
3	SQA	C	1631	-	29,29,29	0.58	0	34,34,34	1.22	4 (11%)
2	C8E	C	1630[B]	-	20,20,20	0.39	0	19,19,19	0.43	0

In the following table, the Chirals column lists the number of chiral outliers, the number of chiral centers analysed, the number of these observed in the model and the number defined in the Chemical Component Dictionary. Similar counts are reported in the Torsion and Rings columns. '-' means no outliers of that kind were identified.

Mol	Type	Chain	Res	Link	Chirals	Torsions	Rings
2	C8E	A	1629	-	-	9/18/18/18	-
3	SQA	B	1631	-	-	2/31/31/31	-
2	C8E	C	1629	-	-	8/18/18/18	-

Continued on next page...

Continued from previous page...

Mol	Type	Chain	Res	Link	Chirals	Torsions	Rings
2	C8E	B	1629	-	-	6/18/18/18	-
2	C8E	B	1630[A]	-	-	7/18/18/18	-
2	C8E	C	1630[A]	-	-	10/18/18/18	-
2	C8E	B	1630[B]	-	-	11/18/18/18	-
3	SQA	A	1630	-	-	1/31/31/31	-
3	SQA	C	1631	-	-	1/31/31/31	-
2	C8E	C	1630[B]	-	-	11/18/18/18	-

There are no bond length outliers.

All (8) bond angle outliers are listed below:

Mol	Chain	Res	Type	Atoms	Z	Observed(°)	Ideal(°)
3	A	1630	SQA	C28-C15-C16	3.12	120.52	115.27
3	C	1631	SQA	C28-C15-C16	2.67	119.76	115.27
3	C	1631	SQA	C8-C9-C10	-2.62	104.37	112.98
3	A	1630	SQA	C12-C11-C10	-2.39	121.91	127.66
3	C	1631	SQA	C4-C5-C6	-2.30	107.42	113.45
3	A	1630	SQA	C4-C5-C6	-2.26	107.54	113.45
3	B	1631	SQA	C4-C5-C6	-2.07	108.03	113.45
3	C	1631	SQA	C8-C7-C6	-2.05	122.72	127.66

There are no chirality outliers.

All (66) torsion outliers are listed below:

Mol	Chain	Res	Type	Atoms
2	B	1630[A]	C8E	O15-C16-C17-O18
3	C	1631	SQA	N2-C3-C4-C5
2	A	1629	C8E	O15-C16-C17-O18
2	C	1630[B]	C8E	O9-C10-C11-O12
2	B	1630[B]	C8E	C6-C7-C8-O9
2	A	1629	C8E	O9-C10-C11-O12
2	C	1630[A]	C8E	O15-C16-C17-O18
2	C	1630[A]	C8E	O18-C19-C20-O21
3	B	1631	SQA	N2-C3-C4-C5
2	C	1630[B]	C8E	C6-C7-C8-O9
2	B	1630[B]	C8E	O18-C19-C20-O21
2	C	1629	C8E	O12-C13-C14-O15
2	A	1629	C8E	C6-C7-C8-O9
2	B	1629	C8E	C4-C5-C6-C7
2	B	1630[B]	C8E	O12-C13-C14-O15

Continued on next page...

Continued from previous page...

Mol	Chain	Res	Type	Atoms
2	B	1630[A]	C8E	C6-C7-C8-O9
2	B	1630[B]	C8E	C4-C5-C6-C7
2	C	1630[B]	C8E	C2-C3-C4-C5
2	B	1629	C8E	O15-C16-C17-O18
2	B	1630[A]	C8E	O12-C13-C14-O15
2	B	1630[B]	C8E	O15-C16-C17-O18
2	B	1630[A]	C8E	C5-C6-C7-C8
2	A	1629	C8E	C2-C3-C4-C5
2	A	1629	C8E	O18-C19-C20-O21
2	C	1629	C8E	O18-C19-C20-O21
2	A	1629	C8E	C4-C5-C6-C7
2	B	1629	C8E	C6-C7-C8-O9
2	C	1629	C8E	C1-C2-C3-C4
2	C	1630[A]	C8E	C5-C6-C7-C8
3	A	1630	SQA	N2-C3-C4-C5
2	C	1630[B]	C8E	C4-C5-C6-C7
2	C	1629	C8E	C20-C19-O18-C17
2	B	1630[A]	C8E	C4-C5-C6-C7
2	B	1630[B]	C8E	C2-C3-C4-C5
2	A	1629	C8E	O12-C13-C14-O15
2	B	1630[B]	C8E	C10-C11-O12-C13
2	B	1630[B]	C8E	C20-C19-O18-C17
2	C	1630[A]	C8E	C11-C10-O9-C8
2	B	1630[A]	C8E	C13-C14-O15-C16
2	A	1629	C8E	C17-C16-O15-C14
2	B	1629	C8E	C2-C3-C4-C5
2	C	1629	C8E	O9-C10-C11-O12
2	C	1630[B]	C8E	C16-C17-O18-C19
2	B	1629	C8E	C17-C16-O15-C14
2	C	1630[B]	C8E	C10-C11-O12-C13
2	A	1629	C8E	C7-C8-O9-C10
2	B	1630[B]	C8E	C7-C8-O9-C10
2	C	1629	C8E	C10-C11-O12-C13
2	C	1630[B]	C8E	O12-C13-C14-O15
2	C	1630[A]	C8E	C10-C11-O12-C13
2	C	1629	C8E	C11-C10-O9-C8
2	C	1630[A]	C8E	C17-C16-O15-C14
2	C	1630[B]	C8E	O15-C16-C17-O18
2	B	1629	C8E	C11-C10-O9-C8
2	C	1630[A]	C8E	C1-C2-C3-C4
2	C	1630[A]	C8E	C16-C17-O18-C19
2	B	1630[A]	C8E	O9-C10-C11-O12

Continued on next page...

Continued from previous page...

Mol	Chain	Res	Type	Atoms
2	B	1630[B]	C8E	O9-C10-C11-O12
2	C	1630[B]	C8E	O18-C19-C20-O21
2	C	1630[A]	C8E	C14-C13-O12-C11
2	C	1629	C8E	O15-C16-C17-O18
2	C	1630[B]	C8E	C13-C14-O15-C16
2	C	1630[B]	C8E	C7-C8-O9-C10
2	C	1630[A]	C8E	O9-C10-C11-O12
3	B	1631	SQA	C29-C19-C20-C21
2	B	1630[B]	C8E	C13-C14-O15-C16

There are no ring outliers.

6 monomers are involved in 12 short contacts:

Mol	Chain	Res	Type	Clashes	Symm-Clashes
2	A	1629	C8E	2	0
2	C	1629	C8E	1	0
2	B	1630[B]	C8E	1	0
3	A	1630	SQA	4	0
3	C	1631	SQA	1	0
2	C	1630[B]	C8E	3	0

The following is a two-dimensional graphical depiction of Mogul quality analysis of bond lengths, bond angles, torsion angles, and ring geometry for all instances of the Ligand of Interest. In addition, ligands with molecular weight > 250 and outliers as shown on the validation Tables will also be included. For torsion angles, if less than 5% of the Mogul distribution of torsion angles is within 10 degrees of the torsion angle in question, then that torsion angle is considered an outlier. Any bond that is central to one or more torsion angles identified as an outlier by Mogul will be highlighted in the graph. For rings, the root-mean-square deviation (RMSD) between the ring in question and similar rings identified by Mogul is calculated over all ring torsion angles. If the average RMSD is greater than 60 degrees and the minimal RMSD between the ring in question and any Mogul-identified rings is also greater than 60 degrees, then that ring is considered an outlier. The outliers are highlighted in purple. The color gray indicates Mogul did not find sufficient equivalents in the CSD to analyse the geometry.

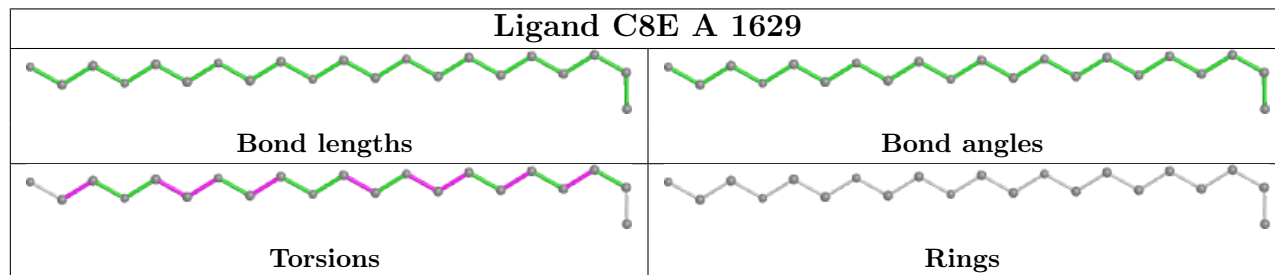

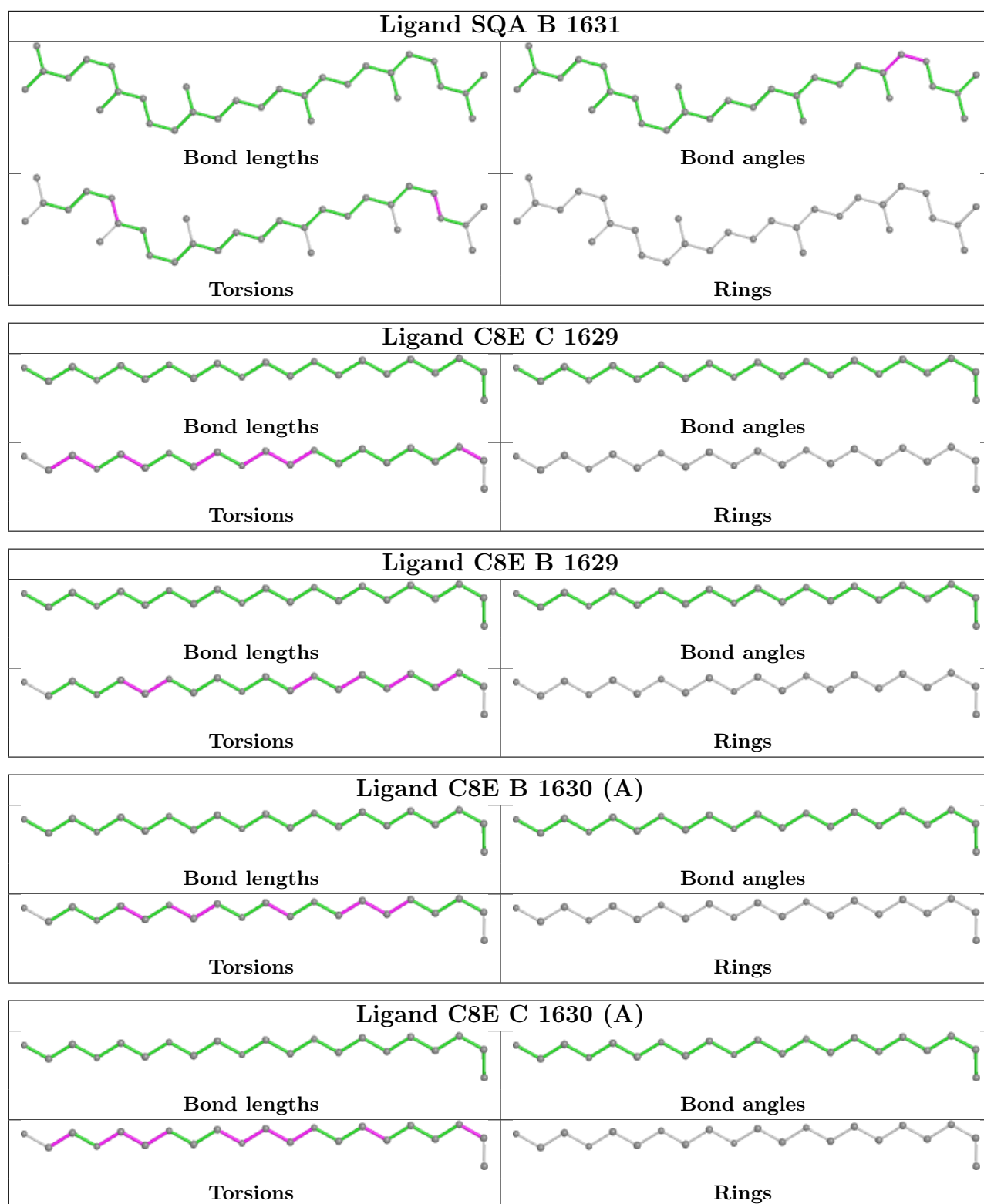

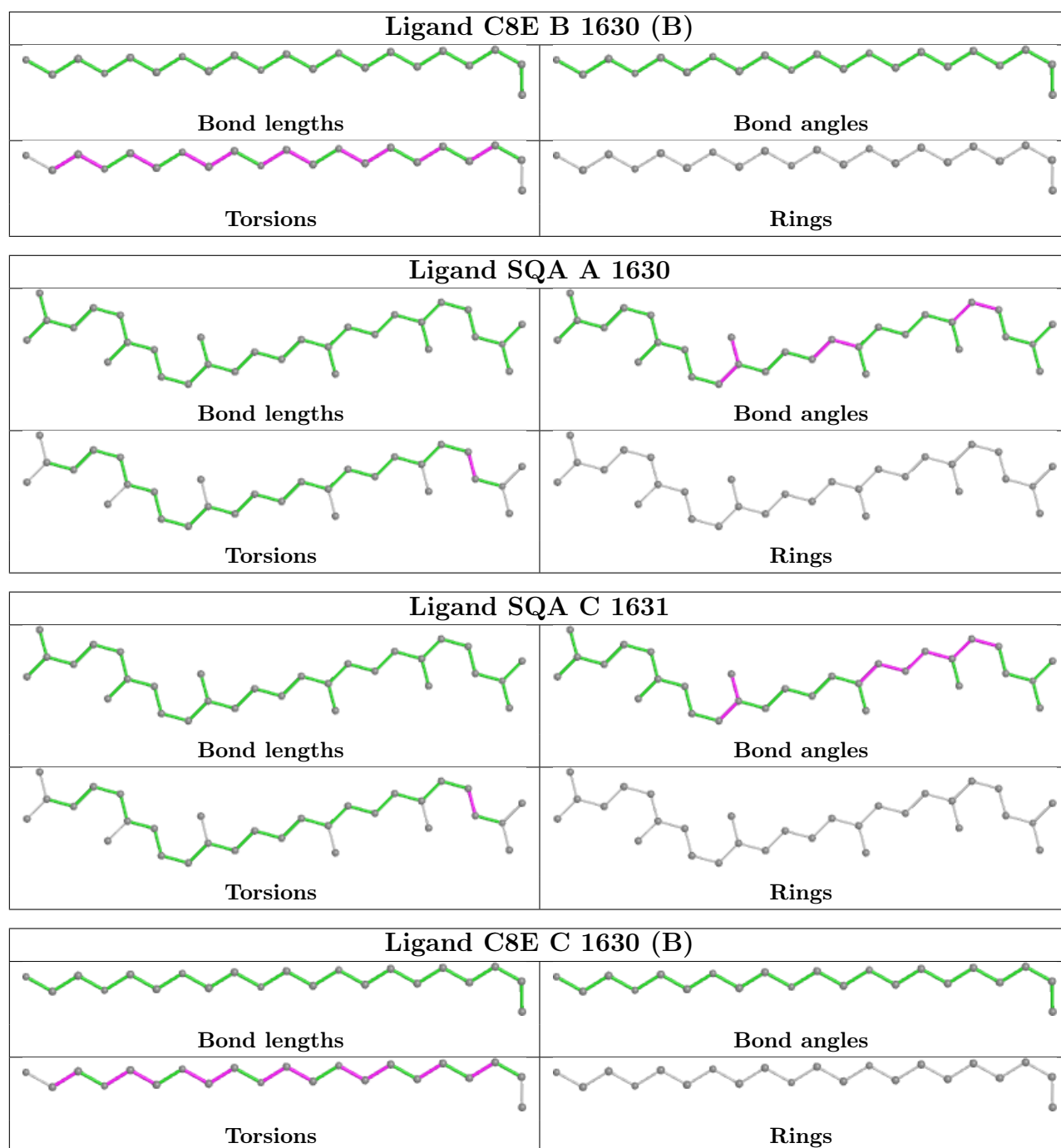

5.7 Other polymers [i](#)

There are no such residues in this entry.

5.8 Polymer linkage issues [i](#)

There are no chain breaks in this entry.

6 Fit of model and data

6.1 Protein, DNA and RNA chains

In the following table, the column labelled ‘#RSRZ > 2’ contains the number (and percentage) of RSRZ outliers, followed by percent RSRZ outliers for the chain as percentile scores relative to all X-ray entries and entries of similar resolution. The OWAB column contains the minimum, median, 95th percentile and maximum values of the occupancy-weighted average B-factor per residue. The column labelled ‘Q < 0.9’ lists the number of (and percentage) of residues with an average occupancy less than 0.9.

Mol	Chain	Analysed	<RSRZ>	#RSRZ>2	OWAB(Å ²)	Q<0.9
1	A	620/631 (98%)	0.54	72 (11%) 4 6	17, 25, 32, 39	0
1	B	620/631 (98%)	-0.06	24 (3%) 39 47	18, 23, 34, 45	0
1	C	620/631 (98%)	0.33	73 (11%) 4 5	18, 24, 32, 44	0
All	All	1860/1893 (98%)	0.27	169 (9%) 9 12	17, 24, 33, 45	0

All (169) RSRZ outliers are listed below:

Mol	Chain	Res	Type	RSRZ
1	B	214	GLY	11.7
1	A	214	GLY	8.1
1	C	212	GLY	8.0
1	C	214	GLY	7.3
1	A	212	GLY	7.2
1	A	204	PRO	7.2
1	A	158	ARG	6.6
1	C	514	PRO	5.9
1	A	629	GLU	5.8
1	A	394	ARG	5.6
1	C	464	ALA	5.5
1	B	158	ARG	5.3
1	B	212	GLY	5.2
1	A	475	LEU	5.1
1	A	213	GLY	4.9
1	C	626	GLN	4.7
1	C	512	ARG	4.5
1	B	213	GLY	4.4
1	C	158	ARG	4.4
1	A	232	SER	4.3
1	C	567	GLY	4.3
1	C	207	ARG	4.2
1	C	202	ASP	4.1

Continued on next page...

Continued from previous page...

Mol	Chain	Res	Type	RSRZ
1	C	570	GLU	4.1
1	C	331	ASP	4.1
1	A	207	ARG	4.0
1	A	427	ASP	4.0
1	A	397	ARG	3.9
1	A	466	LYS	3.9
1	A	543	PRO	3.9
1	A	504	LEU	3.8
1	C	106	ASP	3.8
1	B	394	ARG	3.8
1	A	575	ARG	3.8
1	A	211	LYS	3.8
1	B	191	GLU	3.7
1	A	233	VAL	3.7
1	A	217	ILE	3.7
1	A	507	VAL	3.7
1	A	210	ALA	3.6
1	C	327	PRO	3.6
1	C	568	ARG	3.6
1	A	628	ILE	3.6
1	C	325	GLY	3.6
1	A	485	TRP	3.5
1	A	469	ARG	3.5
1	C	390	LEU	3.5
1	C	334	VAL	3.4
1	A	191	GLU	3.4
1	A	206	ARG	3.4
1	A	202	ASP	3.4
1	A	512	ARG	3.2
1	A	115	ARG	3.2
1	C	332	ARG	3.2
1	B	10	ALA	3.2
1	B	104	SER	3.2
1	C	504	LEU	3.2
1	A	570	GLU	3.2
1	C	459	PHE	3.1
1	B	209	GLY	3.1
1	A	559	ALA	3.1
1	C	628	ILE	3.1
1	C	572	GLU	3.1
1	C	473	GLU	3.0
1	A	514	PRO	3.0

Continued on next page...

Continued from previous page...

Mol	Chain	Res	Type	RSRZ
1	B	106	ASP	3.0
1	B	204	PRO	3.0
1	C	210	ALA	3.0
1	A	395	ARG	2.9
1	C	383	TRP	2.9
1	C	213	GLY	2.9
1	A	621	LEU	2.9
1	A	572	GLU	2.9
1	A	106	ASP	2.9
1	C	211	LYS	2.9
1	A	201	THR	2.9
1	A	208	ARG	2.9
1	B	207	ARG	2.9
1	A	392	ASP	2.9
1	B	202	ASP	2.9
1	A	531	GLY	2.8
1	A	626	GLN	2.8
1	C	467	VAL	2.8
1	C	11	TYR	2.8
1	C	469	ARG	2.8
1	B	427	ASP	2.8
1	A	482	ASP	2.8
1	A	117	ILE	2.8
1	C	517	GLN	2.8
1	C	204	PRO	2.7
1	C	143	GLU	2.7
1	C	236	PHE	2.7
1	B	232	SER	2.7
1	A	515	TYR	2.7
1	B	208	ARG	2.7
1	C	18	ALA	2.7
1	C	394	ARG	2.7
1	A	481	PRO	2.7
1	C	617	PRO	2.7
1	A	565	ALA	2.7
1	C	461	TYR	2.6
1	C	28	ASP	2.6
1	C	318	VAL	2.6
1	A	517	GLN	2.6
1	C	625	LYS	2.6
1	A	391	PRO	2.6
1	B	628	ILE	2.6

Continued on next page...

Continued from previous page...

Mol	Chain	Res	Type	RSRZ
1	B	215	GLY	2.6
1	A	510	ASP	2.5
1	B	504	LEU	2.6
1	A	499	ALA	2.5
1	B	230	LYS	2.5
1	C	391	PRO	2.5
1	C	471	ALA	2.5
1	C	392	ASP	2.5
1	A	340	LEU	2.5
1	C	206	ARG	2.5
1	C	581	LEU	2.5
1	A	159	MET	2.5
1	A	357	ASN	2.5
1	C	232	SER	2.5
1	A	627	ALA	2.5
1	C	14	THR	2.4
1	A	407	ILE	2.4
1	C	510	ASP	2.4
1	C	389	ARG	2.4
1	A	230	LYS	2.4
1	A	329	ASP	2.4
1	C	465	TRP	2.4
1	A	199	TYR	2.4
1	A	328	ALA	2.4
1	C	329	ASP	2.4
1	C	233	VAL	2.3
1	A	218	PHE	2.3
1	A	141	PRO	2.3
1	C	20	GLU	2.3
1	A	203	VAL	2.3
1	C	621	LEU	2.3
1	C	191	GLU	2.3
1	A	500	VAL	2.3
1	C	190	PRO	2.3
1	C	466	LYS	2.2
1	C	157	LYS	2.2
1	C	92	ILE	2.2
1	A	11	TYR	2.2
1	C	104	SER	2.2
1	B	392	ASP	2.2
1	A	327	PRO	2.2
1	C	231	LEU	2.2

Continued on next page...

Continued from previous page...

Mol	Chain	Res	Type	RSRZ
1	C	569	ALA	2.2
1	A	560	LEU	2.1
1	A	414	ASN	2.1
1	C	22	LEU	2.1
1	C	314	THR	2.1
1	C	298	ASP	2.1
1	A	460	GLY	2.1
1	C	460	GLY	2.1
1	C	32	TRP	2.1
1	A	12	ALA	2.1
1	A	144	LYS	2.1
1	A	223	ARG	2.1
1	A	28	ASP	2.1
1	B	59	ASP	2.0
1	C	115	ARG	2.0
1	C	462	ASP	2.0
1	C	324	ALA	2.0
1	C	475	LEU	2.0
1	B	211	LYS	2.0
1	B	233	VAL	2.0

6.2 Non-standard residues in protein, DNA, RNA chains [i](#)

There are no non-standard protein/DNA/RNA residues in this entry.

6.3 Carbohydrates [i](#)

There are no monosaccharides in this entry.

6.4 Ligands [i](#)

In the following table, the Atoms column lists the number of modelled atoms in the group and the number defined in the chemical component dictionary. The B-factors column lists the minimum, median, 95th percentile and maximum values of B factors of atoms in the group. The column labelled 'Q<0.9' lists the number of atoms with occupancy less than 0.9.

Mol	Type	Chain	Res	Atoms	RSCC	RSR	B-factors(Å ²)	Q<0.9
2	C8E	C	1630[A]	21/21	0.74	0.29	43,47,48,49	21
2	C8E	C	1630[B]	21/21	0.74	0.29	30,32,34,34	21
2	C8E	B	1630[A]	21/21	0.75	0.31	40,43,46,47	21

Continued on next page...

Continued from previous page...

Mol	Type	Chain	Res	Atoms	RSCC	RSR	B-factors(\AA^2)	Q<0.9
2	C8E	B	1630[B]	21/21	0.75	0.31	31,32,34,35	21
2	C8E	A	1629	21/21	0.76	0.24	36,43,45,47	21
2	C8E	C	1629	21/21	0.77	0.27	33,41,43,45	21
2	C8E	B	1629	21/21	0.81	0.26	31,43,46,46	21
3	SQA	A	1630	30/30	0.93	0.10	36,39,42,45	0
3	SQA	C	1631	30/30	0.95	0.11	29,30,36,38	0
3	SQA	B	1631	30/30	0.96	0.09	28,30,32,33	0

The following is a graphical depiction of the model fit to experimental electron density of all instances of the Ligand of Interest. In addition, ligands with molecular weight > 250 and outliers as shown on the geometry validation Tables will also be included. Each fit is shown from different orientation to approximate a three-dimensional view.

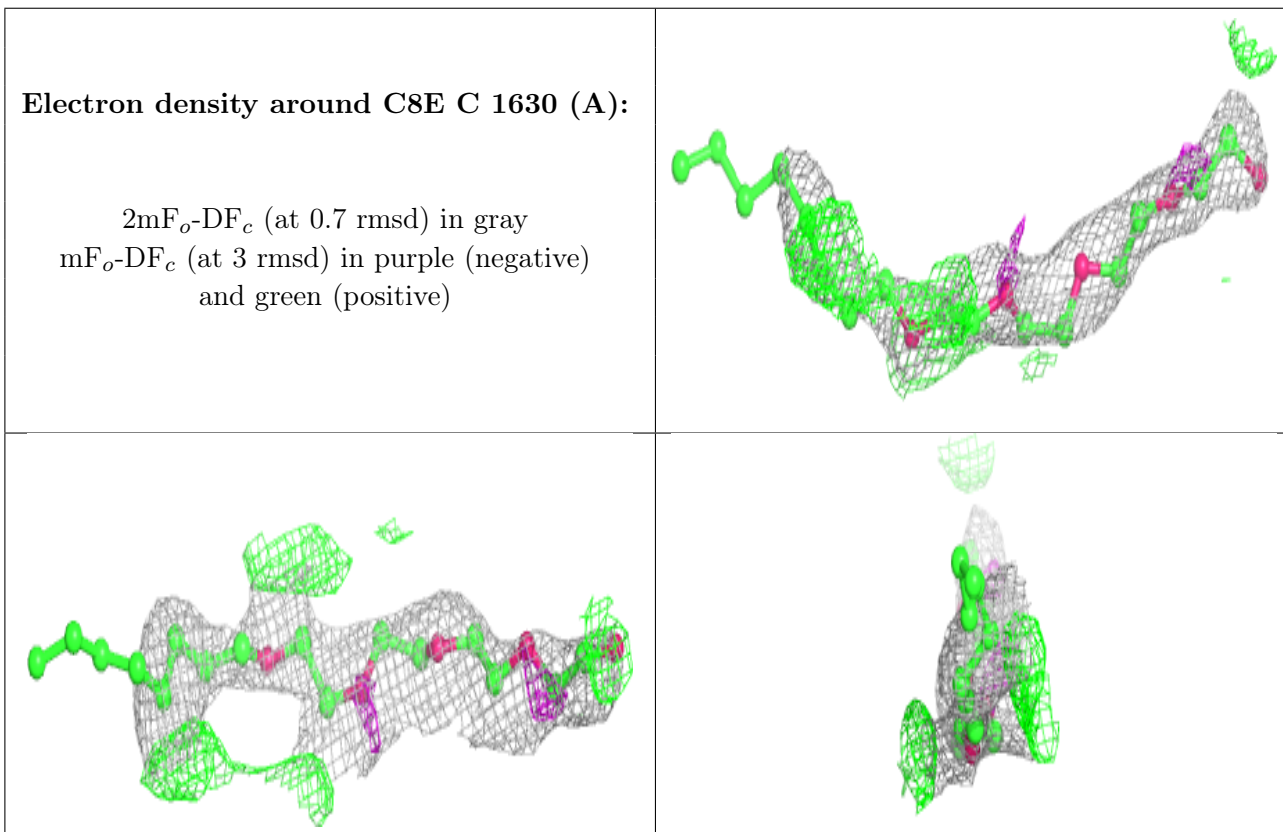

Electron density around C8E C 1630 (B):

$2mF_o-DF_c$ (at 0.7 rmsd) in gray
 mF_o-DF_c (at 3 rmsd) in purple (negative)
and green (positive)

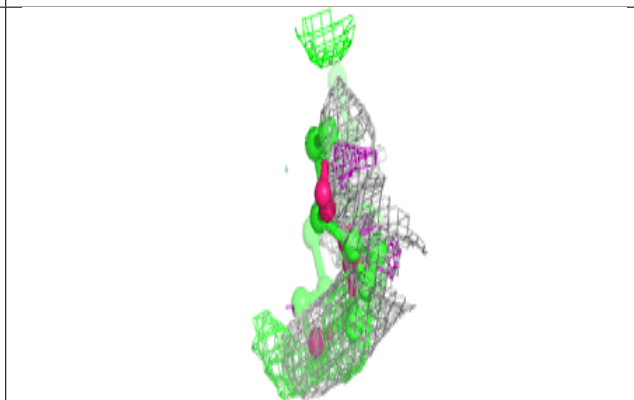
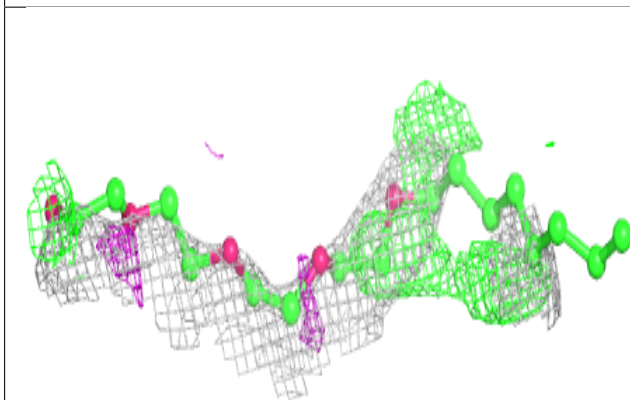
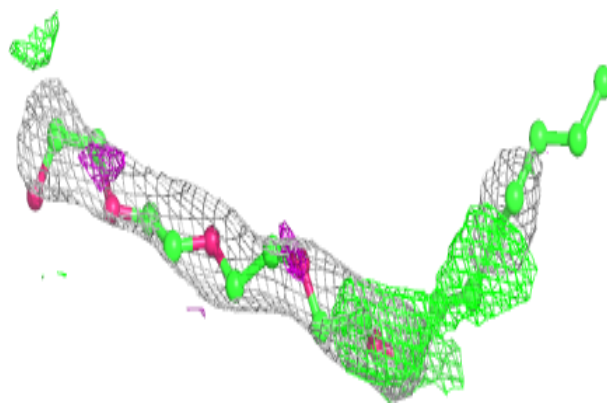
**Electron density around C8E B 1630 (A):**

$2mF_o-DF_c$ (at 0.7 rmsd) in gray
 mF_o-DF_c (at 3 rmsd) in purple (negative)
and green (positive)

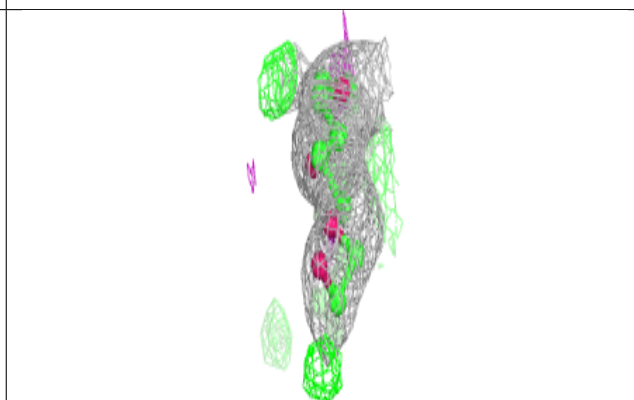
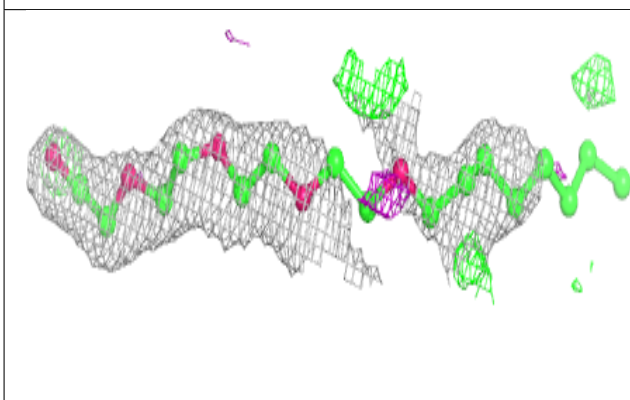
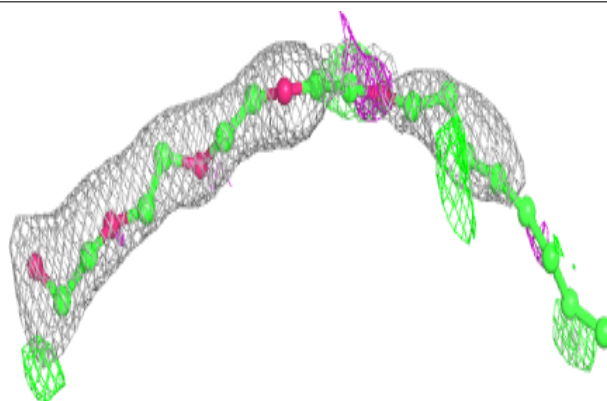

Electron density around C8E B 1630 (B):

$2mF_o-DF_c$ (at 0.7 rmsd) in gray
 mF_o-DF_c (at 3 rmsd) in purple (negative)
and green (positive)

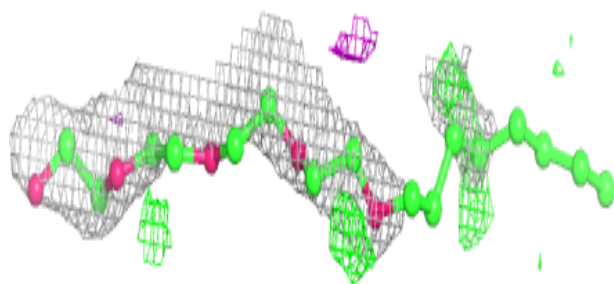
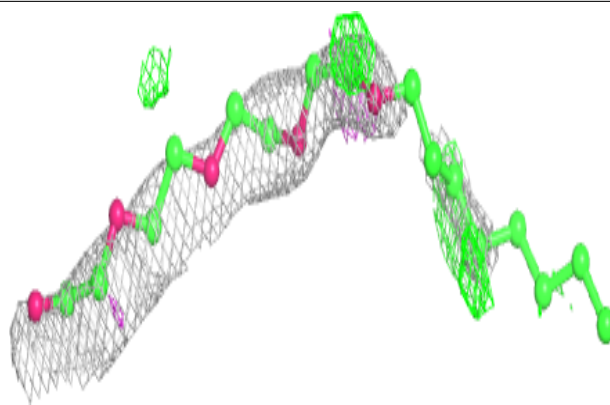
**Electron density around C8E A 1629:**

$2mF_o-DF_c$ (at 0.7 rmsd) in gray
 mF_o-DF_c (at 3 rmsd) in purple (negative)
and green (positive)

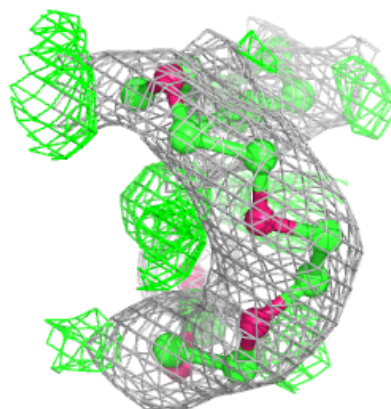
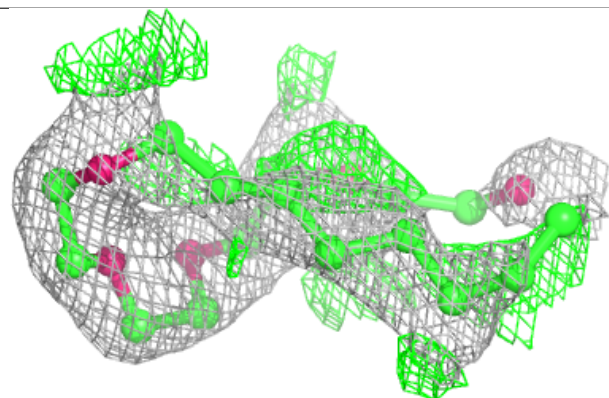
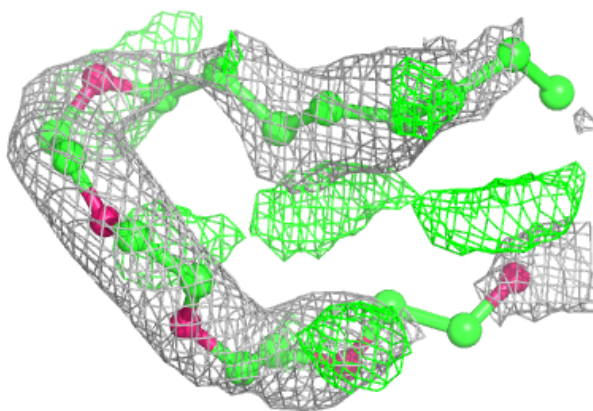

Electron density around C8E C 1629:

$2mF_o-DF_c$ (at 0.7 rmsd) in gray
 mF_o-DF_c (at 3 rmsd) in purple (negative)
and green (positive)

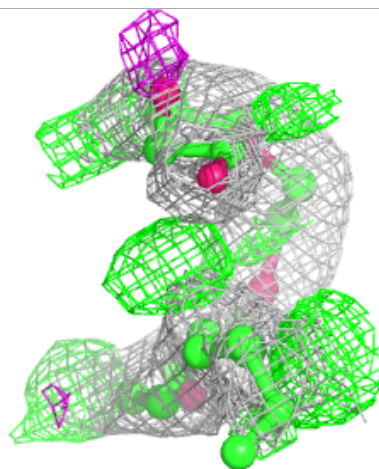
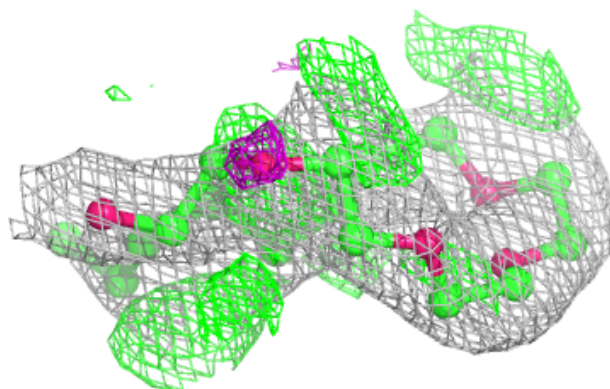
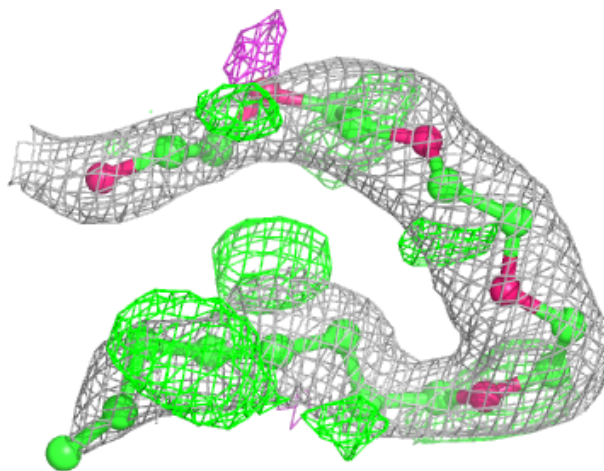

Electron density around C8E B 1629:

$2mF_o-DF_c$ (at 0.7 rmsd) in gray
 mF_o-DF_c (at 3 rmsd) in purple (negative)
and green (positive)

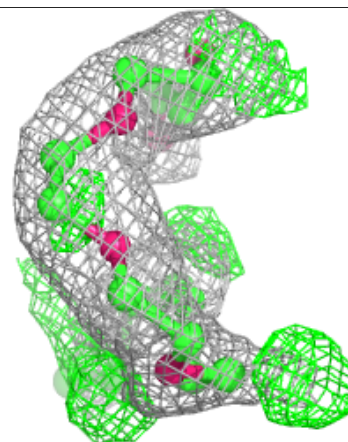
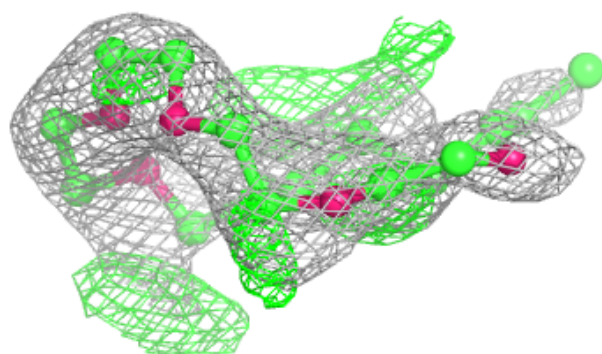
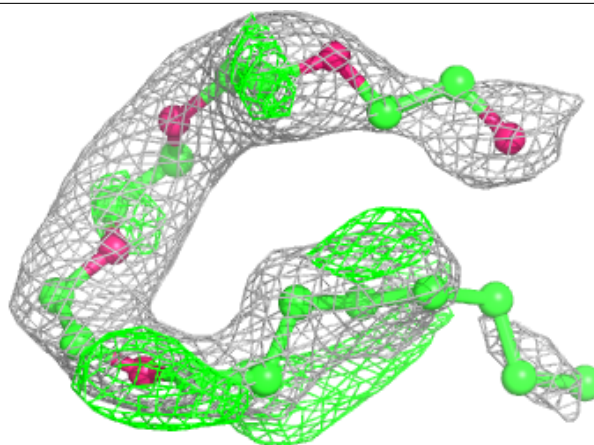
**Electron density around SQA A 1630:**

$2mF_o-DF_c$ (at 0.7 rmsd) in gray
 mF_o-DF_c (at 3 rmsd) in purple (negative)
and green (positive)

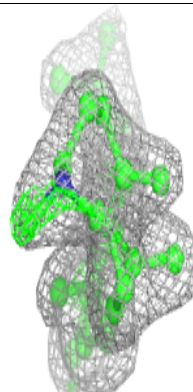
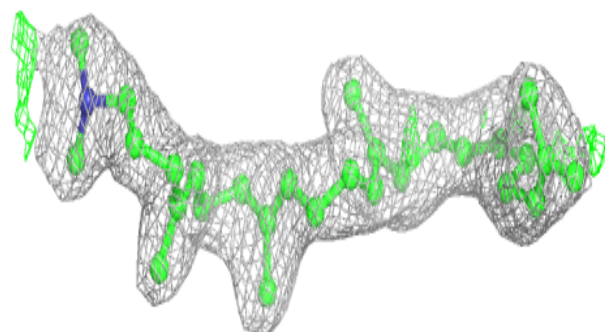
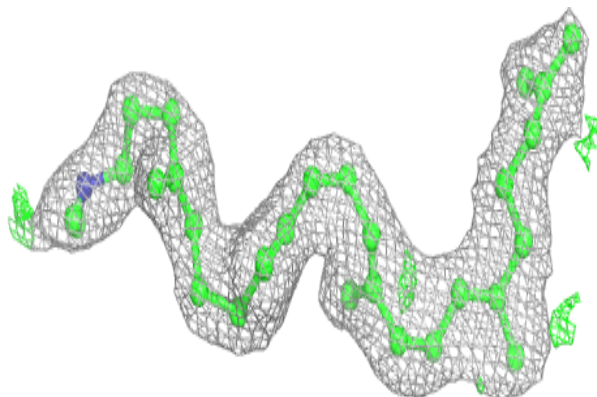

Electron density around SQA C 1631:

$2mF_o-DF_c$ (at 0.7 rmsd) in gray
 mF_o-DF_c (at 3 rmsd) in purple (negative)
and green (positive)

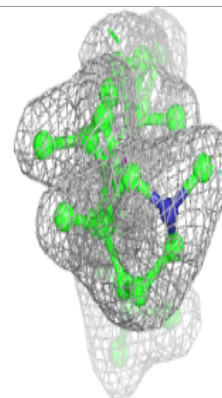
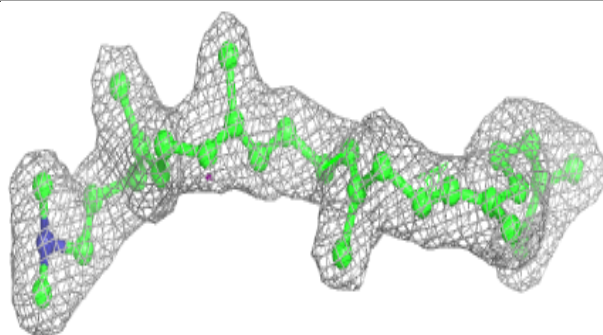
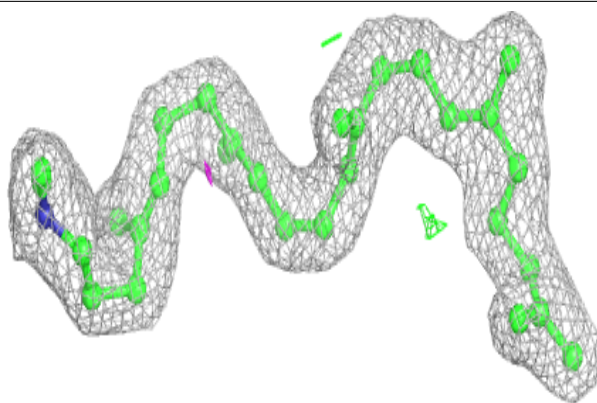
**Electron density around SQA B 1631:**

$2mF_o-DF_c$ (at 0.7 rmsd) in gray
 mF_o-DF_c (at 3 rmsd) in purple (negative)
and green (positive)

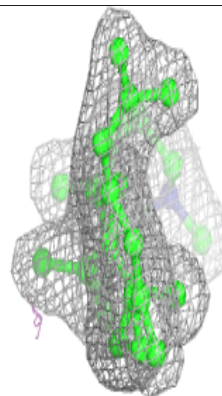
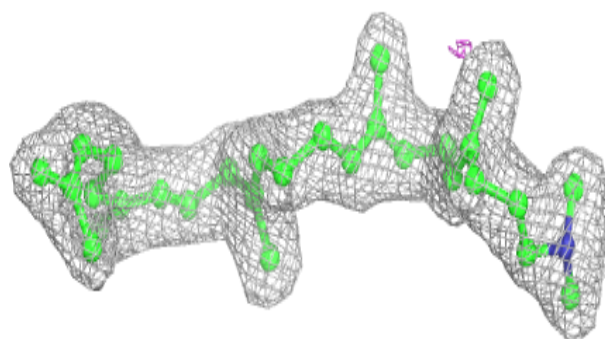
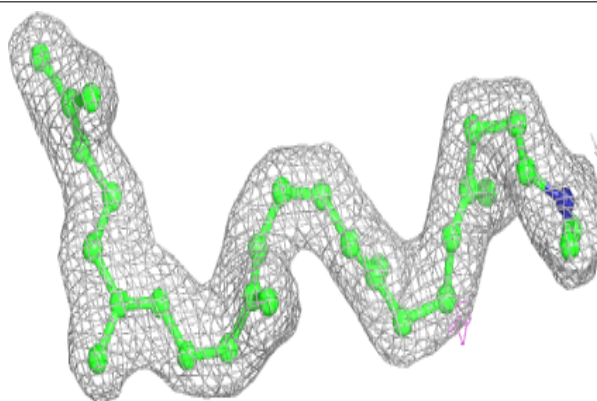

6.5 Other polymers [i](#)

There are no such residues in this entry.