

Key

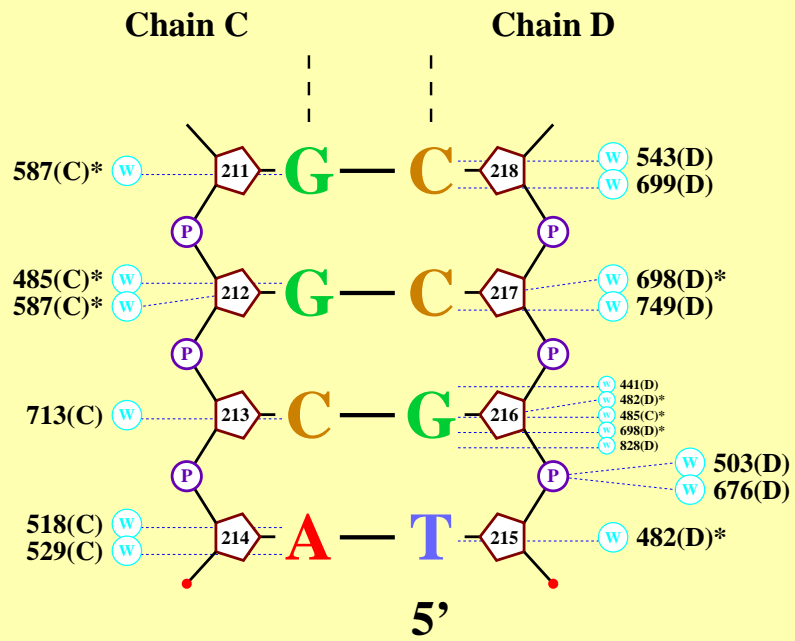

- 3 Backbone sugar and base-number
- P Phosphate group
- * Residue/water on plot more than once



- Hydrogen bond to DNA
- - - - Nonbonded contact to DNA (< 3.35Å)
- 88 W Water molecule and number

file



Key



-  Backbone sugar and base-number
-  Phosphate group
- * Residue/water on plot more than once

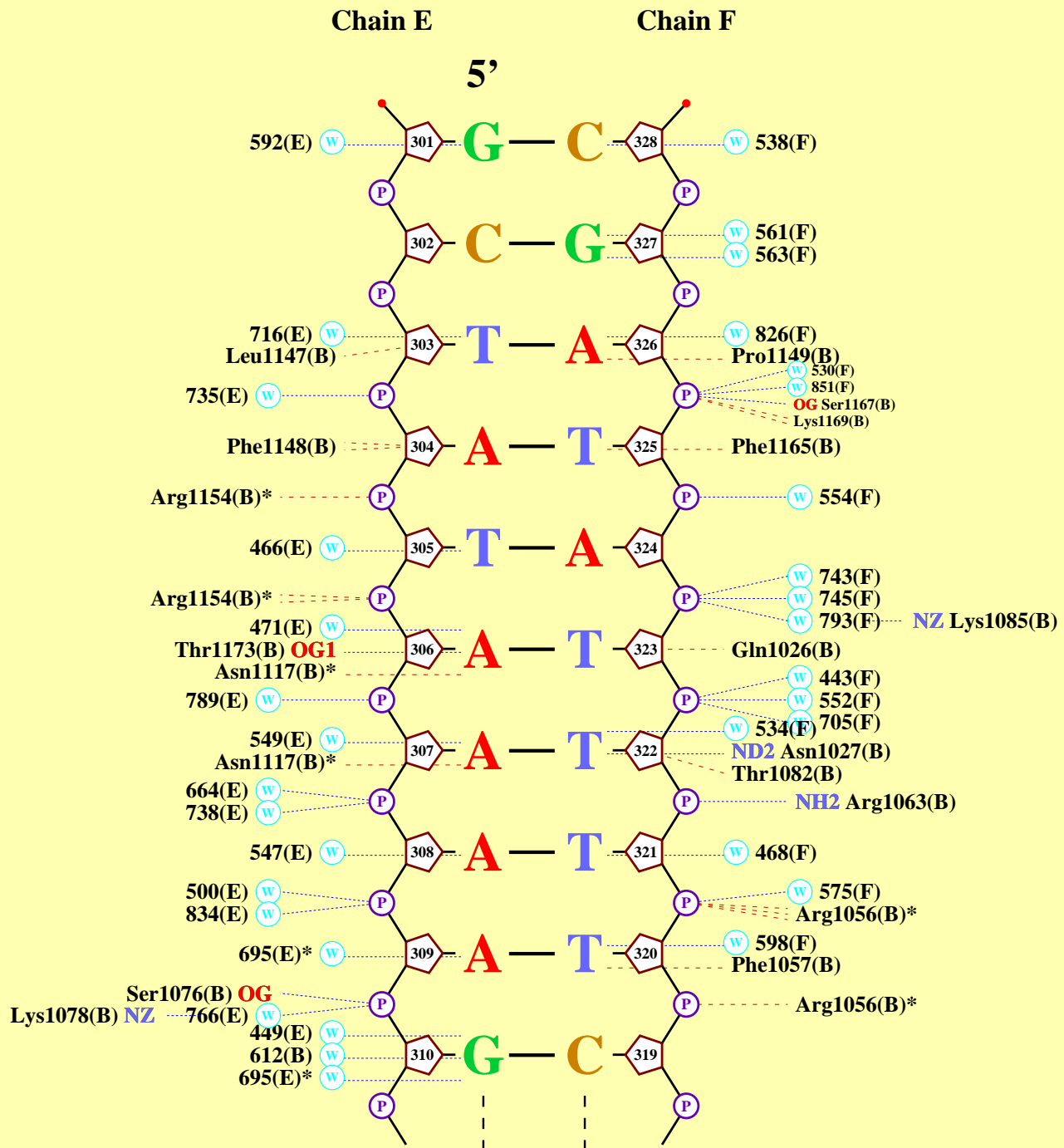

-  Hydrogen bond to DNA
-  Nonbonded contact to DNA (< 3.35Å)
- 88  Water molecule and number

file



Key



-  Backbone sugar and base-number
-  Phosphate group
- * Residue/water on plot more than once



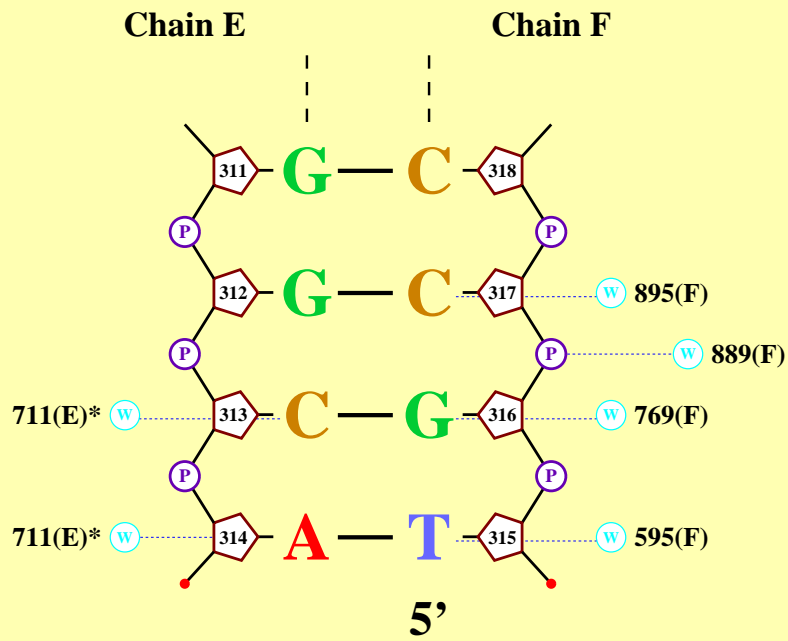

-  Hydrogen bond to DNA
-  Nonbonded contact to DNA (< 3.35Å)
- 88  Water molecule and number

file



Key

-  Backbone sugar and base-number
-  Phosphate group
- * Residue/water on plot more than once

-  Hydrogen bond to DNA
-  Nonbonded contact to DNA (< 3.35Å)
-  88  Water molecule and number

file